

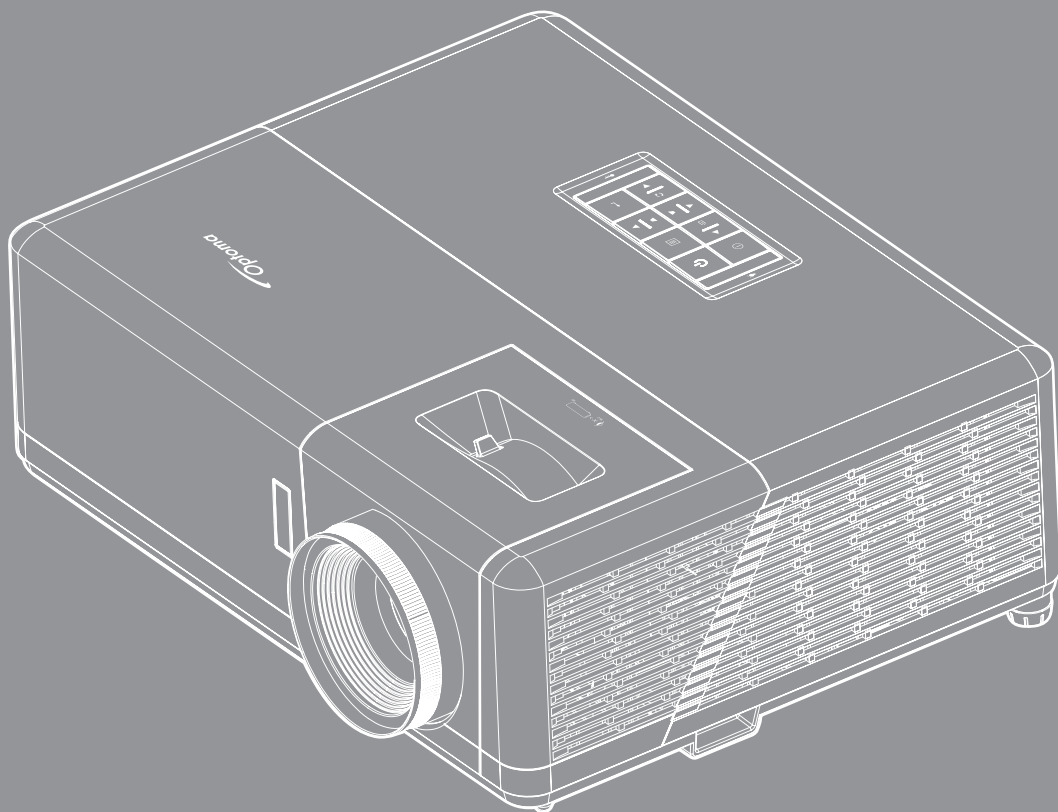

## DLP® Projector





# TABLE OF CONTENTS

<b>SAFETY</b> .....	<b>4</b>
<i>Important Safety Instruction</i> .....	4
<i>Laser Radiation Safety Information</i> .....	5
<i>Cleaning the Lens</i> .....	6
<i>3D Safety Information</i> .....	6
<i>Copyright</i> .....	7
<i>Disclaimer</i> .....	7
<i>Trademark Recognition</i> .....	7
<i>FCC</i> .....	8
<i>Declaration of Conformity for EU countries</i> .....	8
<i>WEEE</i> .....	8
<b>INTRODUCTION</b> .....	<b>9</b>
<i>Package Overview</i> .....	9
<i>Standard accessories</i> .....	9
<i>Product Overview</i> .....	10
<i>Connections</i> .....	11
<i>Keypad</i> .....	12
<i>Remote control</i> .....	13
<b>SETUP AND INSTALLATION</b> .....	<b>14</b>
<i>Installing the projector</i> .....	14
<i>Connecting sources to the projector</i> .....	16
<i>Adjusting the projector image</i> .....	17
<i>Remote setup</i> .....	18
<b>USING THE PROJECTOR</b> .....	<b>20</b>
<i>Powering on / off the projector</i> .....	20
<i>Selecting an input source</i> .....	21
<i>Projector settings menu (OSD)</i> .....	22
<i>OSD Menu tree</i> .....	23
<i>Display menu</i> .....	29
<i>Audio menu</i> .....	35
<i>Setup menu</i> .....	36
<i>Info menu</i> .....	39
<b>ADDITIONAL INFORMATION</b> .....	<b>40</b>
<i>Compatible resolutions</i> .....	40
<i>Image size and projection distance</i> .....	45
<i>Projector dimensions and ceiling mount installation</i> .....	46

<i>Remote control codes</i> .....	47
<i>Troubleshooting</i> .....	49
<i>Warning indicators</i> .....	50
<i>Specifications</i> .....	53
<i>Optoma global offices</i> .....	54

# SAFETY

	The lightning flash with arrow head within an equilateral triangle is intended to alert the user to the presence of uninsulated "dangerous voltage" within the product's enclosure that may be of sufficient magnitude to constitute a risk of electric shock to persons.
	The exclamation point within an equilateral triangle is intended to alert the user to the presence of important operating and maintenance (servicing) instructions in the literature accompanying the appliance.

Please follow all warnings, precautions and maintenance as recommended in this user's guide.

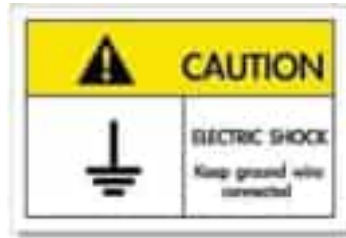

To avoid electric shock, the unit and its peripherals must be properly grounded (earthed).

## Important Safety Instruction

- Do not block any ventilation openings. To ensure reliable operation of the projector and to protect from over heating, it is recommended to install the projector in a location that does not block ventilation. As an example, do not place the projector on a crowded coffee table, sofa, bed, etc. Do not put the projector in an enclosure such as a book case or a cabinet that restricts air flow.
- To reduce the risk of fire and/or electric shock, do not expose the projector to rain or moisture. Do not install near heat sources such as radiators, heaters, stoves or any other apparatus such as amplifiers that emits heat.
- Do not let objects or liquids enter the projector. They may touch dangerous voltage points and short out parts that could result in fire or electric shock.
- Do not use under the following conditions:
  - In extremely hot, cold or humid environments.
    - (i) Ensure that the ambient room temperature is within 5°C ~ 40°C
    - (ii) Relative humidity is 10% ~ 85%
  - In areas susceptible to excessive dust and dirt.
  - Near any appliance generating a strong magnetic field.
  - In direct sunlight.
- Do not use the unit if it has been physically damaged or abused. Physical damage/abuse would be (but not limited to):
  - Unit has been dropped.
  - Power supply cord or plug has been damaged.
  - Liquid has been spilled on to the projector.
  - Projector has been exposed to rain or moisture.
  - Something has fallen in the projector or something is loose inside.
- Do not place the projector on an unstable surface. The projector may fall over resulting in injury or the projector may become damaged.
- Do not block the light coming out of the projector lens when in operation. The light will heat the object and could melt, cause burns or start a fire.

- Please do not open or disassemble the projector as this may cause electric shock.
- Do not attempt to service the unit yourself. Opening or removing covers may expose you to dangerous voltages or other hazards. Please call Optoma before you send the unit for repair.
- See projector enclosure for safety related markings.
- The unit should only be repaired by appropriate service personnel.
- Only use attachments/accessories specified by the manufacturer.
- Do not look into straight into the projector lens during operation. The bright light may harm your eyes.
- When switching the projector off, please ensure the cooling cycle has been completed before disconnecting power. Allow 90 seconds for the projector to cool down.
- Turn off and unplug the power plug from the AC outlet before cleaning the product.
- Use a soft dry cloth with mild detergent to clean the display housing. Do not use abrasive cleaners, waxes or solvents to clean the unit.
- Disconnect the power plug from AC outlet if the product is not being used for a long period of time.
- *Do not setup the projector in places where it might be subjected to vibration or shock.*
- *Do not touch the lens with bare hands.*
- *Remove battery/batteries from remote control before storage. If the battery/batteries are left in the remote for long periods, they may leak.*
- *Do not use or store the projector in places where smoke from oil or cigarettes may be present, as it can adversely affect the quality of the projector performance.*
- *Please follow the correct projector orientation installation as non standard installation may affect the projector performance.*
- *Use a power strip and or surge protector. As power outages and brown-outs can KILL devices.*

## Laser Radiation Safety Information

- This product is classified as CLASS 1 LASER PRODUCT - RISK GROUP 2 of IEC60825-1 : 2014 and also complies with 21 CFR 1040.10 and 1040.11 as a Risk Group 2, LIP (Laser Illuminated Projector) as defined in IEC 62471-5:Ed. 1.0. For more information see Laser Notice No. 57, dated May 8, 2019.

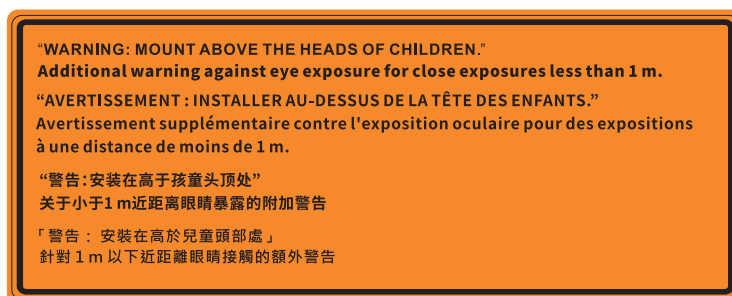
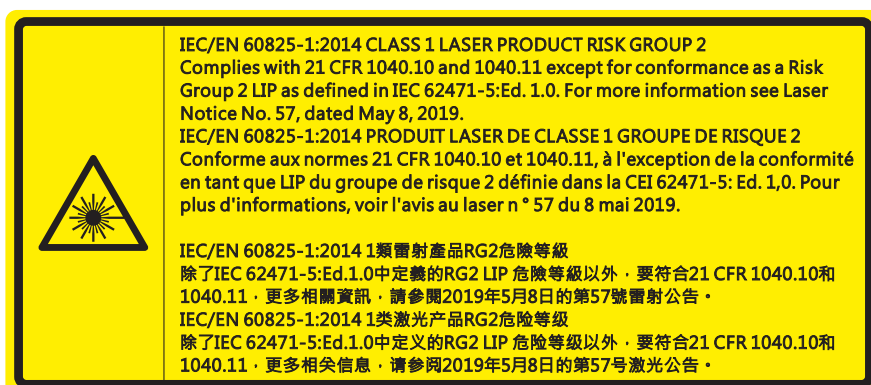

- As with any bright source, do not stare into the direct beam, RG2 IEC 62471-5:2015.
- This projector is class 1 laser product of IEC/EN 60825-1:2014 and risk group 2 with the requirements of IEC 62471-5:2015.

- Additional instructions to supervise children, no staring, and not use optical aids.
- Notice is given to supervise children and to never allow them to stare into the projector beam at any distance from the projector.
- Notice is given to use caution when using the remote control for starting the projector while in front of the projection lens.
- Notice is given to the user to avoid the use of optical aids such as binoculars or telescopes inside the beam.
- When turning on the projector, make sure no one within projection range is looking at the lens.
- Keep any items (magnifying glass etc.) out of the light path of the projector. The light path being projected from the lens is extensive, therefore any kind of abnormal objects that can redirect light coming out of the lens, can cause an unpredictable outcome such as a fire or injury to the eyes.
- Any operation or adjustment not specifically instructed by the user's guide creates the risk of hazardous laser radiation exposure.
- Do not open or disassemble the projector as this may cause damage by the exposure of laser radiation.
- Do not stare into beam when the projector is on. The bright light may result in permanent eye damage.

Without following the control, adjustment or operation procedure may cause damage by the exposure of laser radiation

## Cleaning the Lens

- Before cleaning the lens, be sure to turn off the projector and unplug the power cord to allow it to completely cool down.
- Use a compressed air tank to remove the dust.
- Use a special cloth for cleaning lens and gently wipe the lens. Do not touch the lens with your fingers.
- Do not use alkaline/acid detergents or volatile solvents such as alcohol for cleaning lens. If the lens is damaged due to the cleaning process, it is not covered by the warranty.



Warning: Do not use a spray containing flammable gases to remove dust or dirt from the lens. This may cause a fire due to excessive heat inside the projector.



Warning: Do not clean the lens if the projector is warming up as this may cause the lens' surface film to peel off.



Warning: Do not wipe or tap the lens with a hard object.

## 3D Safety Information

Please follow all warnings and precautions as recommended before you or your child use the 3D function.

### Warning

Children and teenagers may be more susceptible to health issues associated with viewing in 3D and should be closely supervised when viewing these images.

## Photosensitive Seizure Warning and Other Health Risks

- Some viewers may experience an epileptic seizure or stroke when exposed to certain flashing images or lights contained in certain Projector pictures or video games. If you suffer from, or have a family history of epilepsy or strokes, please consult with a medical specialist before using the 3D function.
- Even those without a personal or family history of epilepsy or stroke may have an undiagnosed condition that can cause photosensitive epileptic seizures.
- Pregnant women, the elderly, sufferers of serious medical conditions, those who are sleep deprived or under the influence of alcohol should avoid utilizing the unit's 3D functionality.
- If you experience any of the following symptoms, stop viewing 3D pictures immediately and consult a medical specialist: (1) altered vision; (2) light-headedness; (3) dizziness; (4) involuntary movements

such as eye or muscle twitching; (5) confusion; (6) nausea; (7) loss of awareness; (8) convulsions; (9) cramps; and/ or (10) disorientation. Children and teenagers may be more likely than adults to experience these symptoms. Parents should monitor their children and ask whether they are experiencing these symptoms.

- Watching 3D projection may also cause motion sickness, perceptual after effects, disorientation, eye strain and decreased postural stability. It is recommended that users take frequent breaks to lessen the potential of these effects. If your eyes show signs of fatigue or dryness or if you have any of the above symptoms, immediately discontinue use of this device and do not resume using it for at least thirty minutes after the symptoms have subsided.
- Watching 3D projection while sitting too close to the screen for an extended period of time may damage your eyesight. The ideal viewing distance should be at least three times the screen height. It is recommended that the viewer's eyes are level with the screen.
- Watching 3D projection while wearing 3D glasses for an extended period of time may cause a headache or fatigue. If you experience a headache, fatigue or dizziness, stop viewing the 3D projection and rest.
- Do not use the 3D glasses for any other purpose than for watching 3D projection.
- Wearing the 3D glasses for any other purpose (as general spectacles, sunglasses, protective goggles, etc.) may be physically harmful to you and may weaken your eyesight.
- Viewing in 3D projection may cause disorientation for some viewers. Accordingly, DO NOT place your 3D PROJECTOR near open stairwells, cables, balconies, or other objects that can be tripped over, run into, knocked down, broken or fallen over.

## Copyright

This publication, including all photographs, illustrations and software, is protected under international copyright laws, with all rights reserved. Neither this manual, nor any of the material contained herein, may be reproduced without written consent of the author.

© Copyright 2022

## Disclaimer

The information in this document is subject to change without notice. The manufacturer makes no representations or warranties with respect to the contents hereof and specifically disclaims any implied warranties of merchantability or fitness for any particular purpose. The manufacturer reserves the right to revise this publication and to make changes from time to time in the content hereof without obligation of the manufacturer to notify any person of such revision or changes.

## Trademark Recognition

Kensington is a U.S. registered trademark of ACCO Brand Corporation with issued registrations and pending applications in other countries throughout the world.

HDMI, the HDMI Logo, and High-Definition Multimedia Interface are trademarks or registered trademarks of HDMI Licensing LLC in the United States and other countries.

DLP®, DLP Link and the DLP logo are registered trademarks of Texas Instruments and BrilliantColor™ is a trademark of Texas Instruments.

MHL, Mobile High-Definition Link and the MHL Logo are trademarks or registered trademarks of MHL Licensing, LLC.

All other product names used in this manual are the properties of their respective owners and are Acknowledged.

## FCC

This device has been tested and found to comply with the limits for a Class B digital device pursuant to Part 15 of the FCC rules. These limits are designed to provide reasonable protection against harmful interference in a residential installation. This device generates, uses and can radiate radio frequency energy and, if not installed and used in accordance with the instructions, may cause harmful interference to radio communications.

However, there is no guarantee that interference will not occur in a particular installation. If this device does cause harmful interference to radio or television reception, which can be determined by turning the device off and on is encouraged to try to correct the interference by one or more of the following measures:

- Reorient or relocate the receiving antenna.
- Increase the separation between the device and receiver.
- Connect the device into an outlet on a circuit different from that to which the receiver is connected.
- Consult the dealer or an experienced radio/television technician for help.

## Notice: Shielded cables

All connections to other computing devices must be made using shielded cables to maintain compliance with FCC regulations.

### Caution

Changes or modifications not expressly approved by the manufacturer could void the user's authority, which is granted by the Federal Communications Commission, to operate this projector.

### Operation Conditions

This device complies with Part 15 of the FCC Rules. Operation is subject to the following two conditions:

1. This device may not cause harmful interference and
2. This device must accept any interference received, including interference that may cause undesired operation.

### Notice: Canadian users

This Class B digital apparatus complies with Canadian ICES-003.

Remarque à l'intention des utilisateurs canadiens

Cet appareil numérique de la classe B est conforme à la norme NMB-003 du Canada.

## Declaration of Conformity for EU countries

- EMC Directive 2014/30/EC (including amendments)
- Low Voltage Directive 2014/35/EC
- RED 2014/53/EU (if product has RF function)

## WEEE



### Disposal instructions

Do not throw this electronic device into the trash when discarding. To minimize pollution and ensure utmost protection of the global environment, please recycle it.



# INTRODUCTION

Thank you for purchasing an Optoma 4K UHD projector. For full list of features please visit the product page on our website, where you will also find additional information and documentation such as voice control setup and FAQs.

## Package Overview

Carefully unpack and verify that you have the items listed below under standard accessories. Some of the items under optional accessories may not be available depending on the model, specification and your region of purchase. Please check with your place of purchase. Some accessories may vary from region to region.

The warranty card is only supplied in some specific regions. Please consult your dealer for detailed information.

## Standard accessories

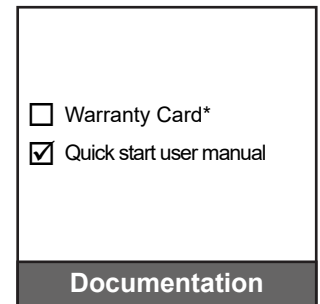
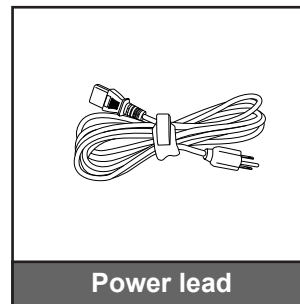
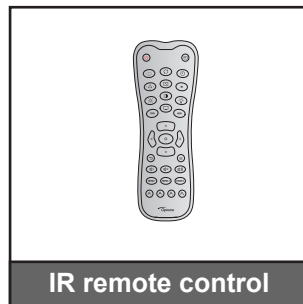
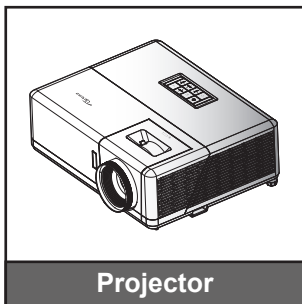

### Note:

- *The actual remote control may vary depending on the region.*
- *The remote control is shipped with batteries.*
- *\*For warranty Information, please visit <https://www.optoma.com/support/download>*
- *For access to the setup information, user manual, warranty information, and product updates – please scan the QR Code or visit the following URL:  
<https://www.optoma.com/support/download>*



# INTRODUCTION

## Product Overview

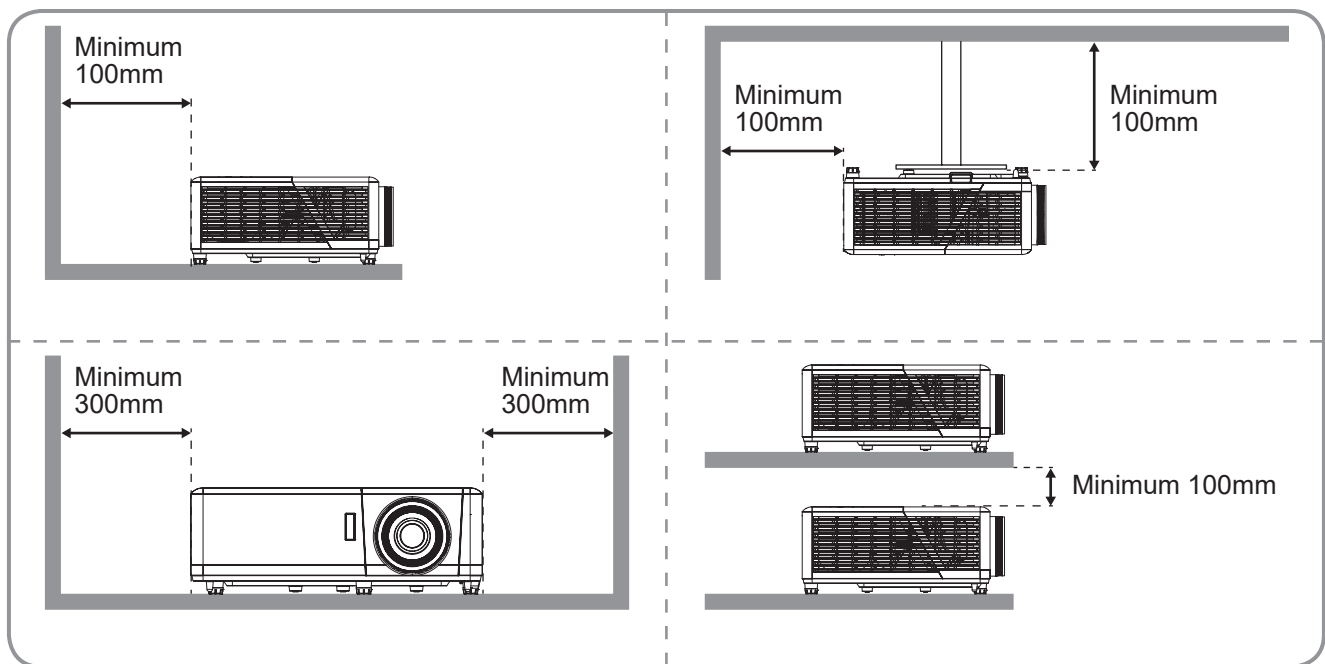
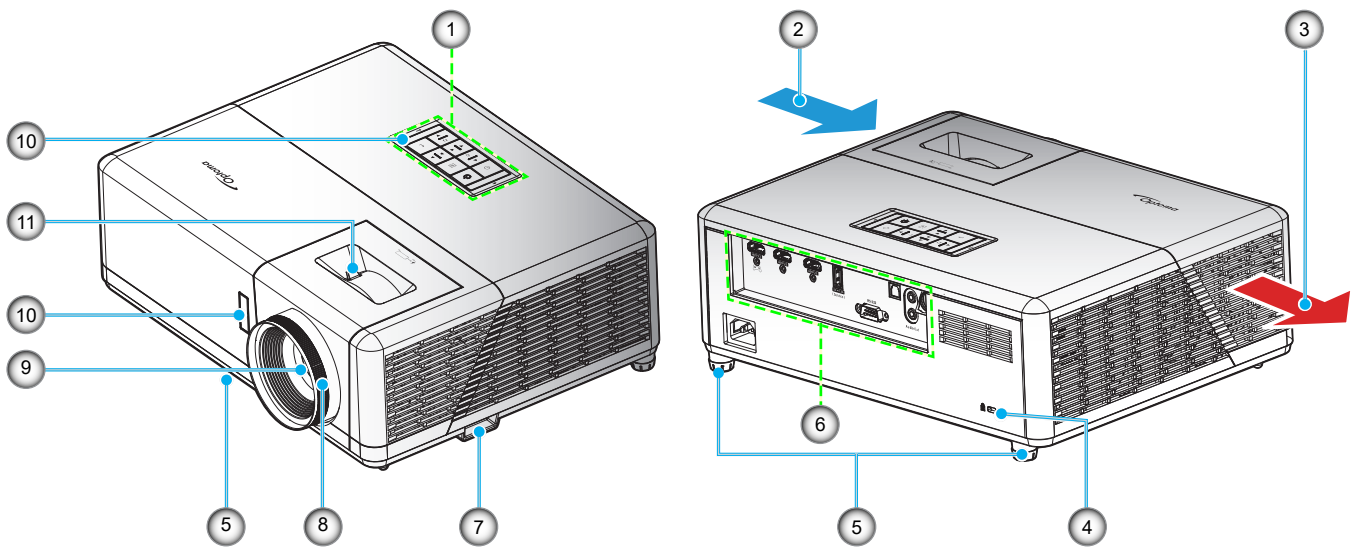

**Note:**

- Do not block projector intake and exhaust vents.
- When operating the projector in an enclosed space, allow at least 30 cm clearance around the intake and exhaust vents.

No	Item	No	Item
1.	Keypad	7.	Security Bar
2.	Ventilation (inlet)	8.	Focus Ring
3.	Ventilation (outlet)	9.	Lens
4.	Kensington™ Lock Port	10.	IR Receiver (front and top)
5.	Tilt-Adjustment Feet	11.	Zoom Lever
6.	Input / Output		

# INTRODUCTION

## Connections

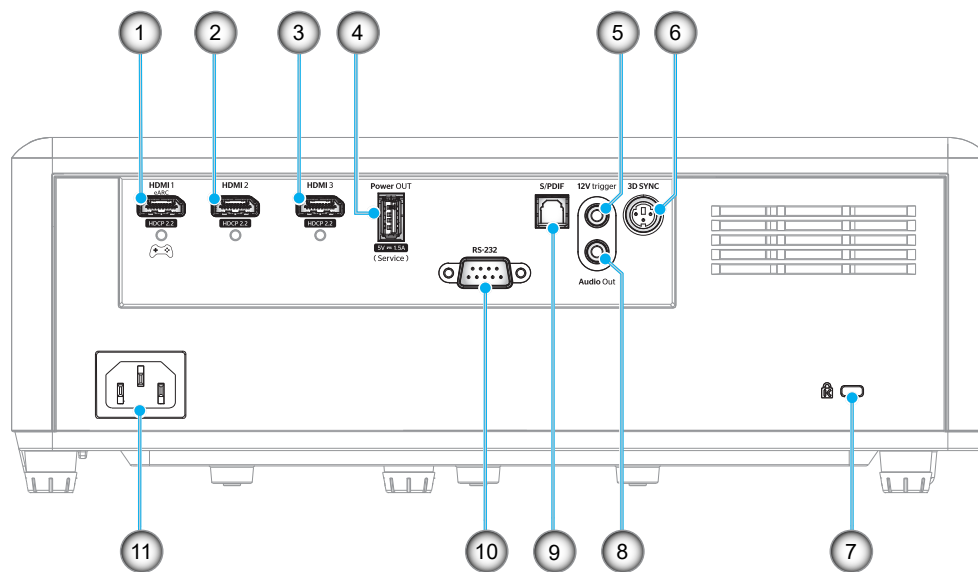

No	Item	No	Item
1.	HDMI 1 Connector (eARC/ARC out; low latency mode)	7.	Kensington™ Lock Port
2.	HDMI 2 Connector (pass eARC audio format through the HDMI-1 connector)	8.	Audio Out Connector
3.	HDMI 3 Connector (pass eARC audio format through the HDMI-1 connector)	9.	S/PDIF Connector <ul style="list-style-type: none"> <li>• Analog Output: 2ch PCM Only</li> <li>• Digital Output: Dolby Digital 5.1 (AC3)</li> </ul>
4.	Power OUT (5V $\overline{=}$ 1.5A) Connector (for service)	10.	RS-232 Connector
5.	12V Trigger (DC output; Volts: 12V, Amps: 0.5A Max)	11.	Power Socket
6.	3D SYNC		

# INTRODUCTION

## Keypad

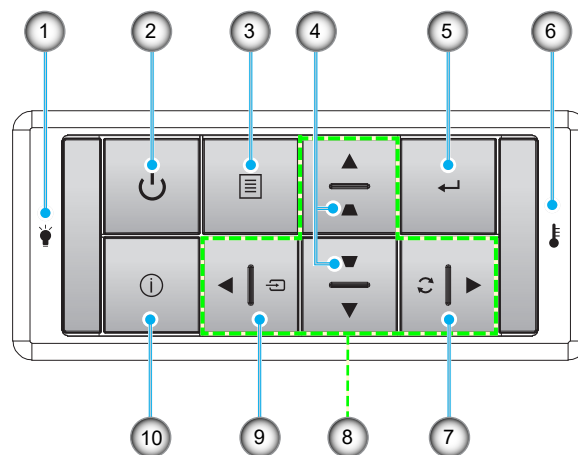

No	Item	No	Item
1.	Light Source LED	6.	Temp LED
2.	Power and Power LED	7.	Re-Sync
3.	Menu	8.	Four Directional Select Keys
4.	Keystone Correction	9.	Source
5.	Enter	10.	Information

# INTRODUCTION

## Remote control

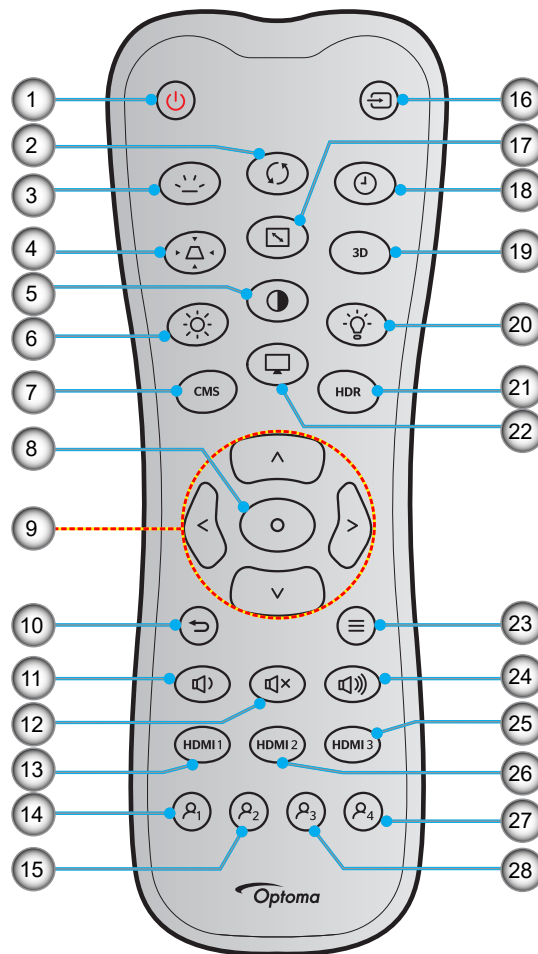

No	Item	No	Item
1.	Power On	15.	User2 (assignable)
2.	Re-sync	16.	Source
3.	Backlight	17.	Aspect Ratio
4.	Keystone	18.	Sleep Timer
5.	Contrast	19.	3D Menu On / Off
6.	Brightness	20.	Lamp
7.	CMS	21.	HDR
8.	Enter	22.	Mode
9.	Four Directional Select Keys	23.	Menu
10.	Return	24.	Vol +
11.	Vol -	25.	HDMI3
12.	Mute	26.	HDMI2
13.	HDMI 1	27.	User4 (assignable)
14.	User1 (assignable)	28.	User3 (assignable)

**Note:**

- The actual remote control may vary depending on the region.
- Some keys may have no function for models that do not support these features.

# SETUP AND INSTALLATION

## Installing the projector

Your projector is designed to be installed in one of four possible positions.

Your room layout or personal preference will dictate which installation location you select. Take into consideration the size and position of your screen, the location of a suitable power outlet, as well as the location and distance between the projector and the rest of your equipment.

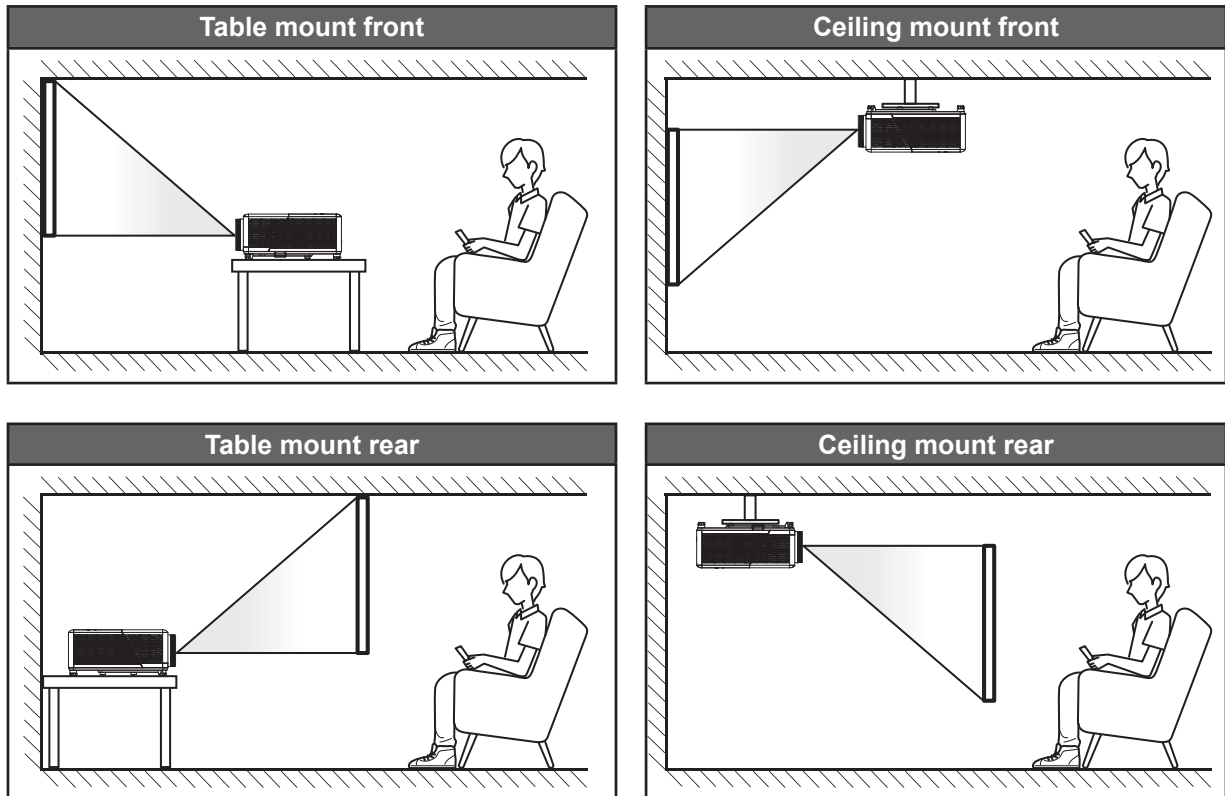

Projector should be placed flat on a surface and 90 degrees / perpendicular to the screen.

- To determine projector location for a given screen size, please refer to distance table on page 45.
- To determine screen size for a given distance, please refer to distance table on page 45.

**Note:** *The further away the projector is placed from the screen the projected image size increases and vertical offset also increases proportionally.*

### **IMPORTANT!**

*Do not operate the projector in any orientation other than table-top, ceiling mount or the following 360° free orientation operation listed below. The projector should be horizontal and not tilted either forwards/backwards or left/right. Any other orientation will invalidate the warranty and may shorten the lifetime performance of the projector. For non-standard installation advice please contact Optoma.*

# SETUP AND INSTALLATION

## Projector installation notice

- 360° free orientation operation

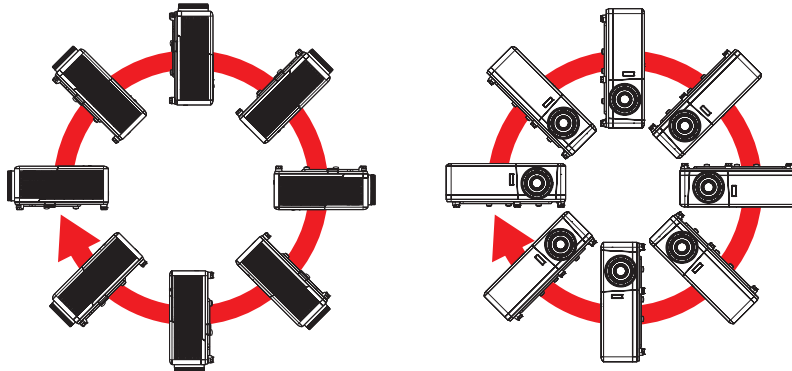

- Allow at least 30 cm clearance around the exhaust vent.

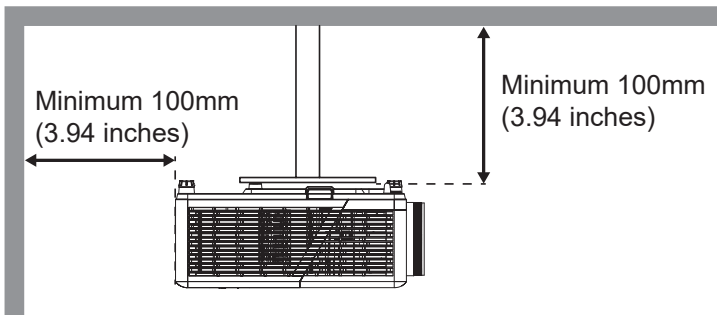
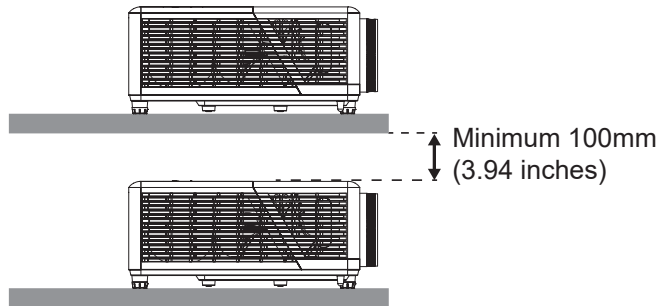
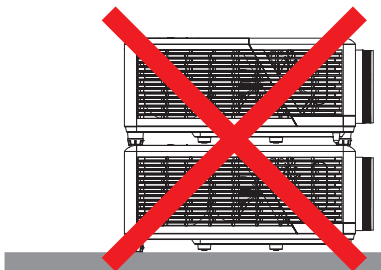
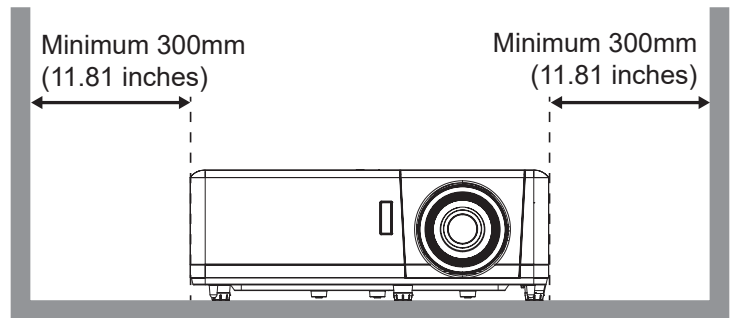
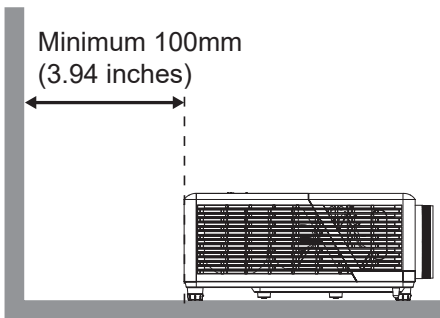

- Ensure that the intake vents do not recycle hot air from the exhaust vent.
- When operating the projector in an enclosed space, ensure that the surrounding air temperature within the enclosure does not exceed operation temperature while the projector is running, and the air intake and exhaust vents are unobstructed.
- All enclosures should pass a certified thermal evaluation to ensure that the projector does not recycle exhaust air, as this may cause the device to shutdown even if the enclosure temperature is within the acceptable operation temperature range.

# SETUP AND INSTALLATION

## Connecting sources to the projector

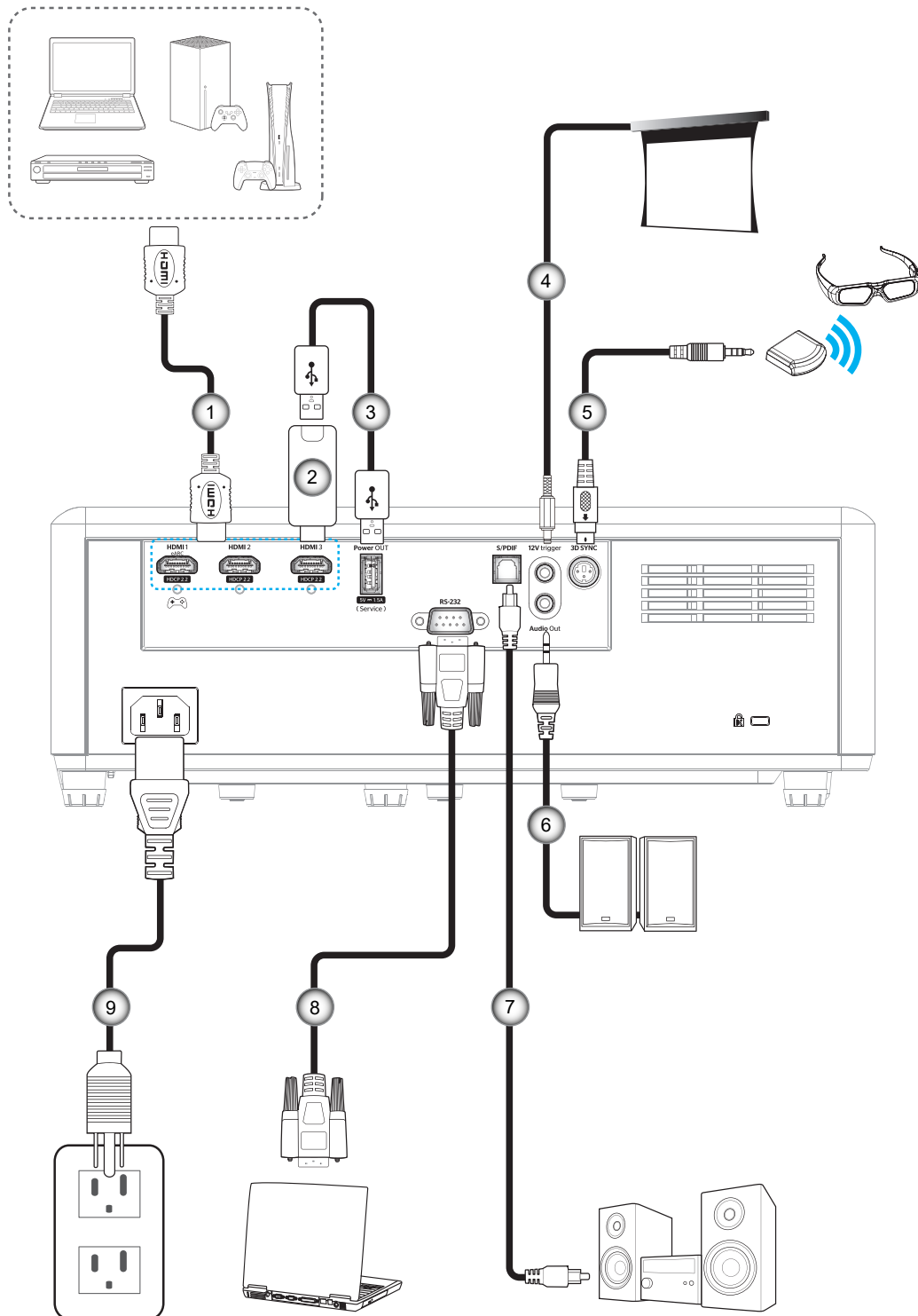

No	Item
1.	HDMI Cable
2.	HDMI Dongle
3.	USB Power Cable

No	Item
4.	12V DC Jack
5.	3D Emitter Cable
6.	Audio Out Cable

No	Item
7.	S/PDIF Out Cable
8.	RS-232 Cable
9.	Power Cord

**Note:** To ensure the best image quality and avoid connection errors, we recommend the use of Premium HDMI cables. For the cable lengths longer than 20-25 feet, we strongly recommend using Active Fiber HDMI cables.



# SETUP AND INSTALLATION

## Adjusting the projector image

### Image height

The projector is equipped with elevator feet for adjusting the image height.

1. Locate the adjustable foot you wish to adjust on the underside of the projector.
2. Rotate the adjustable foot clockwise or counterclockwise to raise or lower the projector.

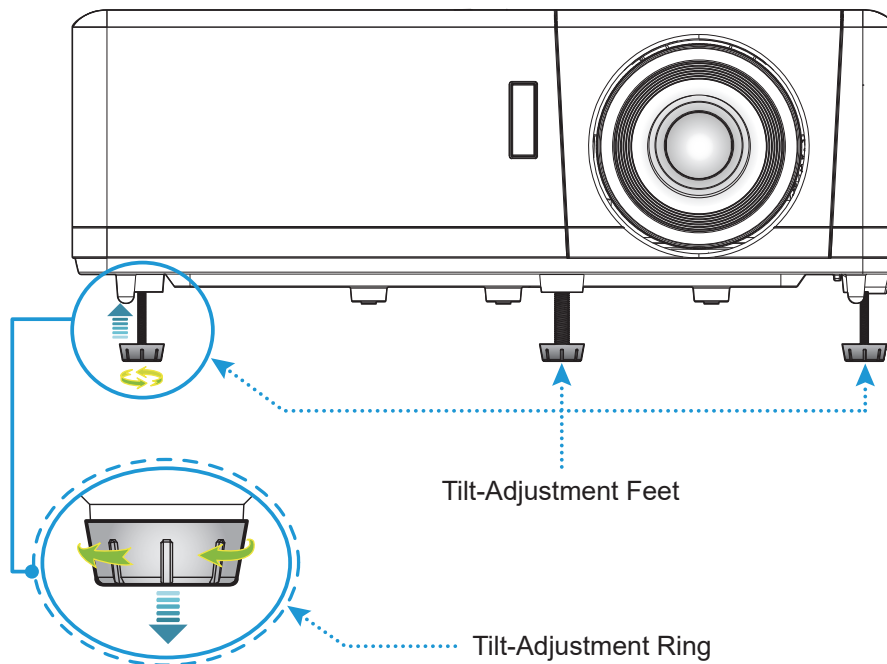

### Zoom and focus

- To adjust the image size turn the zoom lever clockwise or counterclockwise to increase or decrease the projected image size.
- To adjust the focus, turn the focus ring clockwise or counterclockwise until the image is sharp and legible.

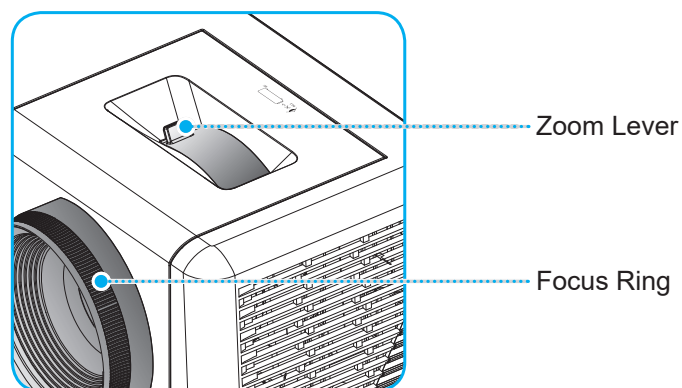

**Note:** The projector will focus at a distance of 1.2m to 9.9m.

# SETUP AND INSTALLATION

## Remote setup

### Installing / replacing the batteries

Two AAA size batteries are supplied for the remote control.

1. Remove the battery cover on the back of the remote control.
2. Insert AAA batteries in the battery compartment as illustrated.
3. Replace back cover on remote control.

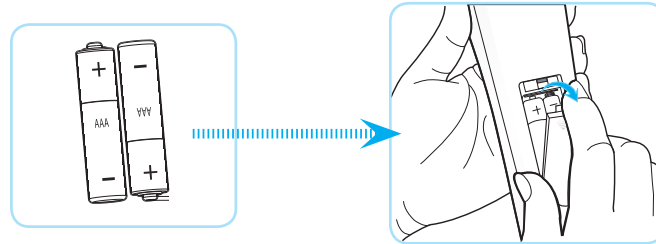

**Note:** Replace only with the same or equivalent type batteries.

### CAUTION

Improper use of batteries can result in chemical leakage or explosion. Be sure to follow the instructions below.

- Do not mix batteries of different types. Different types of batteries have different characteristics.
- Do not mix old and new batteries. Mixing old and new batteries can shorten the life of new batteries or cause chemical leakage in old batteries.
- Remove batteries as soon as they are depleted. Chemicals that leak from batteries that come in contact with skin can cause a rash. If you find any chemical leakage, wipe thoroughly with a cloth.
- The batteries supplied with this product may have a shorter life expectancy due to storage conditions.
- If you will not be using the remote control for an extended period of time, remove the batteries.
- When you dispose of the batteries, you must obey the law in the relative area or country.

# SETUP AND INSTALLATION

## Effective range

Infra-Red (IR) remote control sensor is located on top of the projector. Ensure to hold the remote control at an angle within  $30^\circ$  perpendicular to the projector's top or front IR remote control sensor to function correctly. The distance between the remote control and the sensor should not be longer than 6 meters (~19 feet).

**Note:** When pointing the remote control directly (0 degrees angle) on the IR sensor, the distance between the remote control and the sensor should not be longer than 8 meters (~26 feet).

- Make sure that there are no obstacles between the remote control and the IR sensor on the projector that might obstruct the infra-red beam.
- Make sure the IR transmitter of the remote control is not being shined on directly by sunlight or fluorescent lamps.
- Please keep the remote control at least 2 meters away from fluorescent lamps or the remote control may malfunction.
- If the remote control is close to Inverter-Type fluorescent lamps, it might become ineffective intermittently.
- If the remote control and the projector are too close to each other, the remote control might not function.
- When you aim at the screen, the effective distance is less than 7 meters from the remote control to the screen and reflecting the IR beams back to the projector. However, the effective range might change according to screens.

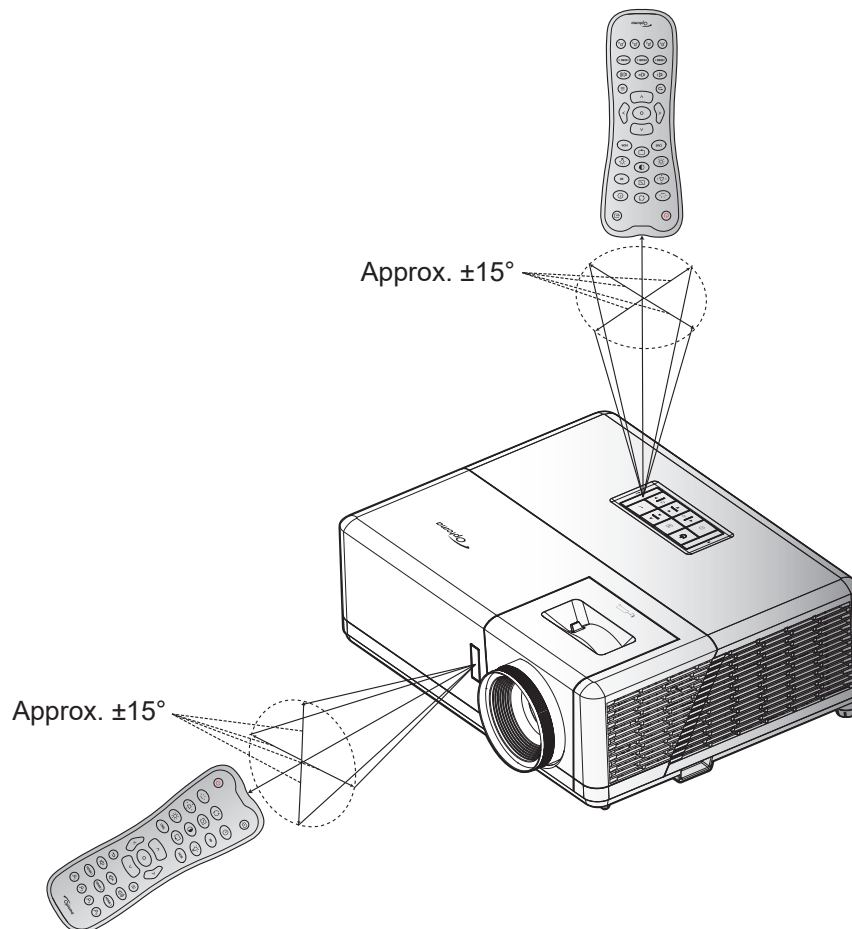

# USING THE PROJECTOR

## Powering on / off the projector

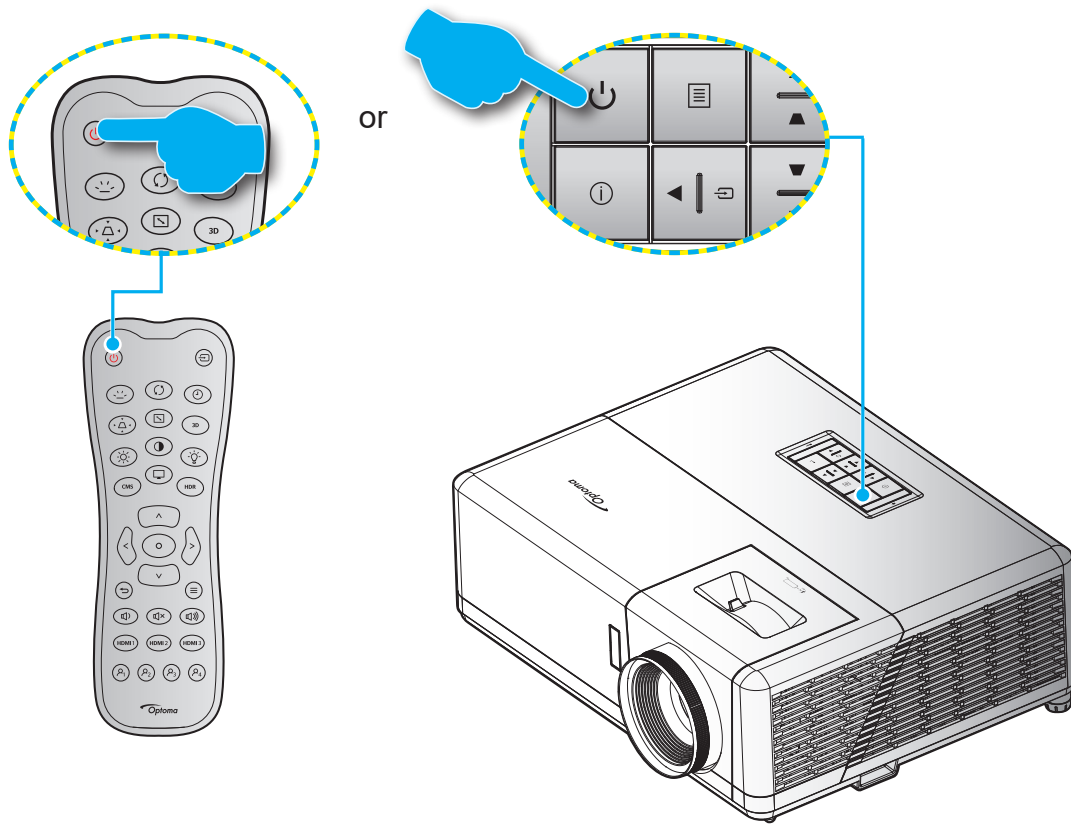

## Powering on

1. Securely connect the power lead and signal/source cable. When connected, the On/Standby LED will turn red.
2. Turn on the projector by pressing the “” button on the projector keypad or the remote control.
3. A start up screen will display in approximately 10 seconds and the On/Standby LED will be flashing blue.

**Note:** *The first time the projector is turned on, you will be prompted to select the preferred language, projection orientation, and other settings.*

# USING THE PROJECTOR

## Powering off

1. Turn off the projector by pressing the “⏻” button on the projector keypad or the remote control.
2. The following message will be displayed:



3. Press the “⏻” button again to confirm, otherwise the message will disappear after 15 seconds. When you press the “⏻” button for the second time, the projector will shut down.
4. The cooling fans will continue to operate for about 10 seconds for the cooling cycle and the On/Standby LED will flash blue. When the On/Standby LED turns solid red, this indicates the projector has entered standby mode. If you wish to turn the projector back on, you must wait until the cooling cycle has finished and the projector has entered standby mode. When the projector is in standby mode, simply press the “⏻” button again to turn on the projector.
5. Disconnect the power lead from the electrical outlet and the projector.

**Note:** It is not recommended that the projector is turned on immediately, right after a power off procedure.

## Selecting an input source

Turn on the connected source that you want to display on the screen, such as computer, notebook, video player, etc. The projector will automatically detect the source. If multiple sources are connected, press the “⏮” button on the projector keypad or the remote control to select the desired input.

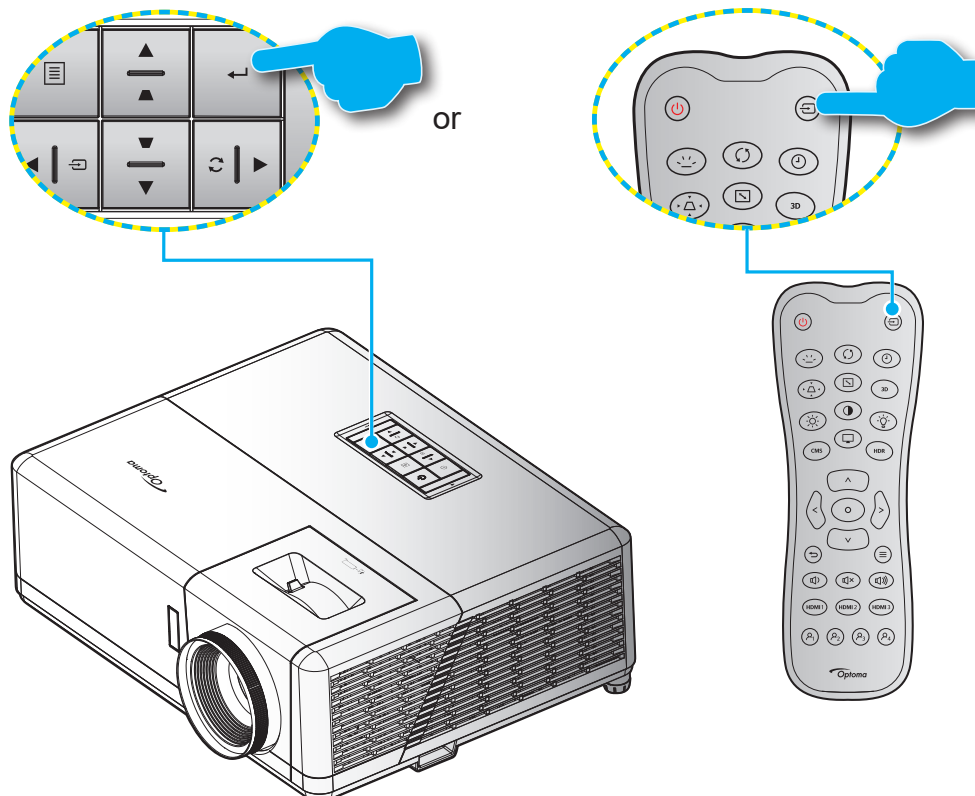

# USING THE PROJECTOR

## Projector settings menu (OSD)

Press “≡” on the remote control, select the OSD menu “🔍” to review projector information or manage various settings related to the image, display, 3D, audio, and setup.

### General menu navigation

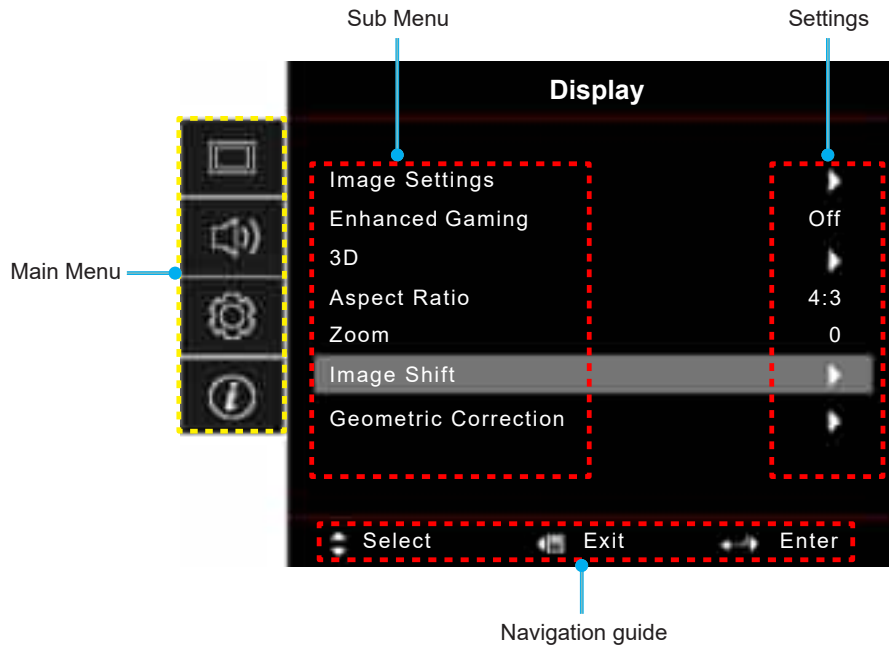

1. When OSD is displayed, use the “**Up**” and “**Down**” navigation buttons to select any item in the main menu. After making a selection on a particular page, press “←” on the keypad or “🔍” on the remote control to enter submenu.
2. Press the “**Left**” and “**Right**” button to select the desired menu item. Then press “←” on the keypad or “🔍” on the remote control to open its sub menu.
3. Press the “**Up**” and “**Down**” button to select the desired item in the sub menu.
4. Press “←” on the keypad or “🔍” on the remote control to enable or disable a setting or press the “**Left**” and “**Right**” button to adjust a value.
5. Select the next item to be adjusted in the sub menu and modify as described above.
6. To exit, press “↩” (repeatedly if necessary). The OSD menu will close and the projector will automatically save the new settings.

# USING THE PROJECTOR

## OSD Menu tree

**Note:** The OSD menu tree items and features are subject to models and region. Optoma reserves the right to add or remove items to improve product performance without notice.







Main Menu	Sub Menu 1	Sub Menu 2	Sub Menu 3	Sub Menu 4	Values	
Display	Image Settings	Display Mode	[Data] Mode		Cinema	
					HDR	
					HLG	
					HDR SIM.	
					Game	
					Reference	
					Bright	
					User	
					3D	
				[Video] Mode		Cinema
					Film	
					HDR	
					HLG	
					HDR SIM.	
					Game	
					Reference	
					Bright	
					User	
			3D			
			ISF Day			
			ISF Night			
			ISF 3D			
			Wall Color		Off (Default)	
					Blackboard	
					Light Yellow	
					Light Green	
					Light Blue	
					Pink	
					Gray	
			Dynamic Range	HDR / HLG		Off
						Auto [Default]
				HDR Picture Mode		Bright
						Standard [Default]
		Film				
	HLG Picture Mode			Detail		
				Bright		
				Standard [Default]		
				Film		
				Detail		
		HDR Brightness		0 ~ 10		

# USING THE PROJECTOR

Main Menu	Sub Menu 1	Sub Menu 2	Sub Menu 3	Sub Menu 4	Values	
Display	Image Settings	Brightness			-50 ~ 50	
		Contrast			-50 ~ 50	
		Sharpness			1 ~ 15	
		Color			-50 ~ 50	
		Tint			-50 ~ 50	
		Gamma	Film			
			Video			
			Graphics			
			Standard(2.2)			
			1.8			
			2.0			
			2.4			
		Color Settings	BrilliantColor™			1 ~ 10
				Color Temperature		Warm
						Standard
						Cool
					Cold	
			Color Matching	Color		Red [Default]
						Green
						Blue
						Cyan
						Yellow
						Magenta
						White(*)
					Hue / R(*)	-50 ~ 50 [Default: 0]
					Saturation / G(*)	-50 ~ 50 [Default: 0]
				Gain / B(*)	-50 ~ 50 [Default: 0]	
				Reset	Cancel [Default]	
					Yes	
				Exit		
			RGB Gain/Bias	Red Gain		-50 ~ 50
		Green Gain			-50 ~ 50	
		Blue Gain			-50 ~ 50	
		Red Bias			-50 ~ 50	
		Green Bias			-50 ~ 50	
		Blue Bias			-50 ~ 50	
		Reset		Cancel [Default]		
				Yes		
		Color Space	[Not HDMI Input]		Auto [Default]	
					RGB	
					YUV	
[HDMI Input]			Auto [Default]			
			RGB(0~255)			
			RGB(16~235)			
			YUV			



# USING THE PROJECTOR

Main Menu	Sub Menu 1	Sub Menu 2	Sub Menu 3	Sub Menu 4	Values	
Display	Image Settings	Brightness Mode			DynamicBlack	
					Eco.	
					Constant Power Power = 100%/95%/90%/85%/80%/75%/70%/65%/60%/55%/50%	
					Constant Luminance Power=85%/80%/75%/70%	
		Reset				
	Enhanced Gaming					Off
						On
	3D	3D Mode				Off [Default]
						On
		3D Sync Invert				On
	Aspect Ratio					Off [Default]
						4:3
						16:9
						21:9
						32:9
						V-Stretch (except SVGA XGA model)
						Full screen
	Zoom					Auto
	Image Shift					-5 ~ 25 [Default: 0]
		H 				-100 ~ 100 [Default: 0]
		V 				-100 ~ 100 [Default: 0]
	Geometric Correction	Four Corner				
		H Keystone				-30 ~ 30 [Default: 0]
		V Keystone				-30 ~ 30 [Default: 0]
		Auto V Keystone				Off
						On [Default]
		3x3 Warp				
Reset						
Audio	Audio Mode				Speaker / Audio Out [Default]	
					SPDIF / eARC	
	Mute					Off [Default]
					On	
Volume					0 ~ 10 [Default: 5]	
Setup	Projection				Front  [Default]	
					Rear 	
					Ceiling-top 	
					Rear-top 	

# USING THE PROJECTOR

Main Menu	Sub Menu 1	Sub Menu 2	Sub Menu 3	Sub Menu 4	Values	
Setup	Power Settings	Direct Power On			Off [Default]	
					On	
		Signal Power On			Off [Default]	
					On	
		Auto Power Off (min.)			0 ~ 180 (5 min increments) [Default: 20]	
		Sleep Timer (min.)	Always On			0 ~ 990 (30 min increments) [Default: 0]
						No [Default]
				Yes		
	Power Mode (Standby)				Active	
					Eco [Default]	
	USB Power (Standby)				Off [Default]	
					On	
	Security	Security			Off	
					On	
		Security Timer	Month			
			Day			
			Hour			
	Change Password				[Default: 1234]	
	HDMI Link Settings	HDMI Link				Off [Default]
						On
		Inclusive of TV				No [Default]
						Yes
		Power On Link				Mutual [Default]
						PJ --> Device
						Device --> PJ
	Power Off Link				Off [Default]	
					On	
	Test Pattern					Green Grid
						Magenta Grid
						White Grid
						White
						Off
	Remote Settings	IR Function				On [Default]
						Off
	Projector ID					00 ~ 99
	12V Trigger					On
						Off [Default]

# USING THE PROJECTOR

Main Menu	Sub Menu 1	Sub Menu 2	Sub Menu 3	Sub Menu 4	Values		
Setup	Options	Language			English [Default]		
					Deutsch		
					Français		
					Italiano		
					Español		
					Português		
					繁體中文		
					簡體中文		
					日本語		
					한국어		
				Русский			
			Menu Settings	Menu Location			Top Left 
						Top Right 	
						Center  [Default]	
						Bottom Left 	
						Bottom Right 	
				Menu Timer			Off
							5sec
							10sec [Default]
				Auto Source			Off [Default]
							On
			Input Source			HDMI1	
						HDMI2	
						HDMI3	
			Input Name		HDMI1	Default [Default] / Custom	
					HDMI2	Default [Default] / Custom	
					HDMI3	Default [Default] / Custom	
			High Altitude			Off [Default]	
						On	
			Display Mode Lock			Off [Default]	
						On	
			Keypad Lock			Off [Default]	
						On	
			Information Hide			Off [Default]	
						On	
			Logo			Default [Default]	
						Neutral	

# USING THE PROJECTOR

Main Menu	Sub Menu 1	Sub Menu 2	Sub Menu 3	Sub Menu 4	Values
Setup	Options	Background Color			None [Default for Video/Pro-AV]
					Blue [Default for Data model]
					Red
					Green
					Gray
	Reset	Reset OSD			Cancel [Default]
					Yes
		Reset to Default			Cancel [Default]
				Yes	
Info	Regulatory				
	Serial Number				
	Source				
	Resolution				00x00
	Refresh Rate				0.00Hz
	Display Mode				
	Projector ID				00~99
	Brightness Mode				
	FW Version	System			
MCU					

# USING THE PROJECTOR

## Display menu

### Image settings menu

#### Display Mode

There are several predefined display modes that you can choose from to suit your viewing preference. Each mode has been fine-tuned by our expert color team to ensure superior color performance for wide range of content.

- **Cinema/Film:** Provides the best balance of detail and colors for watching movies.
- **HDR:** Delivers color that is highly accurate, exceeding the color performance of the other display modes. This mode decodes and displays High Dynamic Range (HDR) content for the deepest blacks, brightest whites, and vivid cinematic color using REC.2020 color gamut.  
**Note:** *This mode will be automatically enabled if HDR is set to Auto (and HDR content is sent to projector – 4K UHD Blu-ray, 1080p/4K UHD HDR games, 4K UHD streaming video). While HDR mode is active, all other display modes will be greyed out.*
- **HLG:** Delivers color that is highly accurate, exceeding the color performance of the other display modes. This mode decodes and displays Hybrid Log Gamma (HLG) content for the deepest blacks, brightest whites, and vivid cinematic color using REC.2020 color gamut.  
**Note:**
  - *This mode will be automatically enabled if HDR is set to Auto (and HLG content is sent to projector). While HLG mode is active, all other display modes will be greyed out.*
  - *Only HDMI1 and HDMI2 support HLG.*
- **HDR SIM.:** Enhances non-HDR content with simulated High Dynamic Range (HDR). Choose this mode to enhance gamma, contrast, and color saturation for non-HDR content (720p and 1080p Broadcast/Cable TV, 1080p Blu-ray, non-HDR Games, etc).  
**Note:** *This mode can ONLY be used with non-HDR content.*
- **Game:** Optimises your projector for maximum contrast and vivid colors allowing you to see shadow detail when playing video game.  
**Note:** *This display mode cannot be used when viewing HDR video content or playing HDR games. To enable low input lag, please ensure the PC or console is connected to HDMI1 and enable Enhanced Game Mode.*
- **Reference:** This mode reproduces image colors as close as possible to the way the movie director intended. Color, color temperature, brightness, contrast and gamma settings are all configured to Rec.709 color gamut. Select this mode for the most accurate color reproduction when watching movies.
- **Bright:** This mode is suitable for environments where extra-high brightness is required, such as using the projector in well-lit rooms.
- **User:** Memorizes user defined setting, tailor your own display mode settings.
- **3D:** Optimized settings for watching 3D content.  
**Note:** *To experience the 3D effect, you will need to have compatible DLP Link 3D glasses. See 3D section for more information.*
- **ISF Day:** Save professionally calibrated picture settings optimized for day time viewing.
- **ISF Night:** Save professionally calibrated picture settings optimized for night time viewing.
- **ISF 3D:** Save professionally calibrated picture settings optimized for 3D viewing.

#### **Note:**

- ISF modes need to be professionally calibrated. To unlock and access ISF modes, you will need to enter the following code using the remote or keypad: Power > Up > Down > Up > Up.
- ISF modes are available only in Video mode.
- If HDR or HLG are enabled, Cinema, Game, Reference, and Bright options are grayed out.

# USING THE PROJECTOR

## Wall Color

Designed to adjust the colors of the projected image when projecting on to a wall without a screen. Each mode has been fine-tuned by our expert color team to ensure superior color performance. There are several predefined modes that you can choose from to suit the color of your wall. Select between off, blackboard, light yellow, light green, light blue, pink, and gray.

**Note:** For accurate color reproduction, we recommend using a screen.

## Dynamic Range

Configure the High Dynamic Range (HDR) setting and its effect when displaying video from 4K Blu-ray players and streaming devices.

### ➤ HDR/HLG

- **Off:** Turn off HDR or HLG processing. When set to Off, the projector will NOT decode HDR or HLG content.
- **Auto:** Auto detect HDR signal.

### ➤ HDR Picture Mode

- **Bright:** Choose this mode for brighter more saturated colors.
- **Standard:** Choose this mode for natural looking colors with a balance of warm and cool tones.
- **Film:** Choose this mode for improved detail and image sharpness.
- **Detail:** The signal comes from OETF conversion to achieve the best color matching and highest level of detail.

### ➤ HLG Picture Mode

- **Bright:** Choose this mode for brighter more saturated colors.
- **Standard:** Choose this mode for natural looking colors with a balance of warm and cool tones.
- **Film:** Choose this mode for improved detail and image sharpness.
- **Detail:** The signal comes from OETF conversion to achieve the best color matching and highest level of detail.

### ➤ HDR Brightness

- Adjust the brightness of HDR Content. The impact of this setting varies based on content. Adjusting the setting to near maximum or maximum can result in a loss of image detail (content dependant).

## Brightness

Adjust the brightness of the image.

## Contrast

The contrast controls the degree of difference between the lightest and darkest parts of the picture.

## Sharpness

Adjust the sharpness of the image.

## Color

Adjust a video image from black and white to fully saturated color.

## Tint

Adjust the color balance of red and green.

## Gamma

Set up gamma curve type. After the initial setup and fine tuning is completed, utilize the Gamma Adjustment steps to optimize your image output.

# USING THE PROJECTOR

- **Film:** For home theater.
- **Video:** For video or TV source.
- **Graphics:** For PC / Photo source.
- **Standard(2.2):** For standardized setting.
- **1.8 / 2.0 / 2.4:** For specific PC / Photo source. 2.4 can also be used for video content and games to enable deeper contrast.

**Note:** *These options are only available if the 3D mode function is disabled.*

## Color Settings

Configure the color settings.

- **BrilliantColor™:** This adjustable item utilizes a new color-processing algorithm and enhancements to enable higher brightness while providing true, more vibrant colors in picture.
- **Color Temperature:** Select a color temperature from Warm, Standard, Cool, and Cold.
- **Color Matching:** Select the following options:
  - Color: Adjust the red (R), green (G), blue (B), cyan (C), yellow (Y), magenta (M), and white (W) level of the image.
  - Hue: Adjust the color balance of red and green.
  - Saturation: Adjust a video image from black and white to fully saturated color.
  - Gain: Adjust the image brightness.
  - Reset: Return the factory default settings for color matching.
  - Exit: Exit the “Color Matching” menu.
- **RGB Gain/Bias:** This settings allows to configure the brightness (gain) and contrast (bias) of an image.
  - Reset: Return the factory default settings for RGB gain/bias.
  - Exit: Exit the “RGB Gain/Bias” menu.
- **Color Space (HDMI1 only):** Select an appropriate color matrix type from the following: Auto, RGB(0-255), RGB(16-235), and YUV.
- **Color Space (HDMI2/Component only):** Select an appropriate color matrix type from the following: Auto, RGB(0-255), and RGB(16-235).

**Note:** *Color Space function is not supported if the source is HDMI3.*

## Brightness Mode

Manually choose the power percentage for brightness mode and adjust the brightness mode settings.

- **DynamicBlack:** Use to automatically adjust the picture brightness in order to give optimum contrast performance.
- **Eco.:** Choose “Eco.” to dim the projector laser diode which will lower power consumption and extend the laser diode life.
- **Constant Power:** Choose the power percentage for brightness mode.
- **Constant Luminance:** Constant Luminance varies the strength of LD luminance such that the brightness maintains consistent with time.

## Reset

Return the factory default settings for color settings.

# USING THE PROJECTOR

## Enhanced Gaming menu

Enable this feature to reduce response times (input latency) during gaming to 4.5ms for HDMI Port 1. All geometry settings (example: Keystone, Warping) will be disabled when Enhanced Gaming Mode is enabled. Additional information below.

### Note:

- Only supported on HDMI1.
- 4.5ms is only supported with 1080p 240Hz signals when using a High-Performance Gaming PC with appropriate Video Card.
- Signal input lag table is below (values can vary slightly): 4K120Hz Signal is NOT supported.

Source Timing	Enhanced Gaming	Output Timing	Output Resolution	Input Lag
1080p60	On	1080p240Hz	1080p	17ms
1080p120	On	1080p240Hz	1080p	8.6ms
1080p240	On	1080p240Hz	1080p	4ms
4K60	On	4K60	4K	16.9ms
1080p60	Off	4K60	1080p	33.8ms
1080p120	Off	4K60	1080p	17ms
1080p240	Off	4K60	1080p	8.6ms
4K60	Off	4K60	4K	33.7ms

- Please note that when “Enhanced Gaming” mode is enabled – 3D Playback, Aspect Ratio, Zoom, Image Shift, and Geometric Correction functions are disabled automatically. These functions and settings will be restored when “Enhanced Gaming Mode” is disabled.

## 3D menu

### 3D Mode

Use this option to enable/disable the 3D mode function.

### 3D Sync Invert

Use this option to enable/disable the 3D sync invert function.

## Aspect Ratio menu

Select the aspect ratio of the displayed image between the following options:

- **4:3:** This format is for 4:3 input sources.
- **16:9/21:9/32:9:** These formats are for 16:9/21:9/32:9 input sources, like HDTV and DVD enhanced for Wide screen TV.
- **V-Stretch:** This mode stretches a 2.35:1 image vertically removing the black bars.
- **Full Screen:** Use this special 2.0:1 aspect ratio to display both 16:9 and 2.35:1 aspect ratio movies without black bars at the top and bottom of the screen.
- **Auto:** Automatically selects the appropriate display format.

### Note:

- *Detailed informations about V-Stretch mode:*
  - Some Letter-Box Format DVDs are not enhanced for 16x9 TVs. In this situation, the image will not look right when displaying image in 16:9 mode. In this situation, please try to use the 4:3 mode to view the DVD. If the content is not 4:3, there will be black bars around the image in 16:9 display. For this type of content, you can use V-Stretch mode to fill the image on the 16:9 display.
  - If you use an external anamorphic lens, this V-Stretch mode also allows you to watch a 2.35:1 content (include Anamorphic DVD and HDTV film source) that supports anamorphic wide is enhanced for 16x9 Display in a wide 2.35:1 image. In this case, there are no black bars. Light source power and vertical resolution are fully utilized.



# USING THE PROJECTOR

- To use the Full Screen format, do the following:
  - a) Set the screen aspect ratio to 2.0:1.
  - b) Select "Full Screen" format.
  - c) Align the projector image correctly on the screen.

## 4K UHD scaling table:

16 : 9 screen	480i/p	576i/p	720p	1080i/p	2160p
4x3	Scale to 2880 x 2160.				
16x9	Scale to 3840 x 2160.				
21x9	Scale to 3840 x 1644				
32x9	Scale to 3840 x 1080				
V-Stretch	Get the central 3840 x 1620 image, and then scale to 3840 x 2160 for display				
Full screen	Scale to 5068 x 2852 (132% enlarged), then get the central 3840 x 2160 image to display <b>Note:</b> Use this format to hide subtitles of the 2.35:1 source and fill 100% of UHD DMD.				
Auto	-If source is 4:3, auto resize to 2880 x 2160 -If source is 16:9 auto resize to 3840 x 2160 -If source is 15:9 auto resize to 3600 x 2160 -If source is 16:10 auto resize to 3456 x 2160				

## Auto mapping rule:

	Input resolution		Auto/Scale	
	H-resolution	V-resolution	3840	2160
4:3	800	600	2880	2160
	1024	768	2880	2160
	1280	1024	2880	2160
	1400	1050	2880	2160
	1600	1200	2880	2160
Wide Laptop	1280	720	3840	2160
	1280	768	3600	2160
	1280	800	3456	2160
SDTV	720	576	2700	2160
	720	480	3240	2160
HDTV	1280	720	3840	2160
	1920	1080	3840	2160

# USING THE PROJECTOR

## Zoom menu

Use to reduce or magnify an image on the projection screen.

**Note:** *Zoom settings are retained on power cycle of the projector.*

## Image Shift menu

Adjust the projected image position horizontally (H) or vertically (V).

**Note:** *The image size will reduce slightly when adjusting the horizontal and vertical keystone.*

## Geometric Correction menu

- **Four Corner:** This setting allows the projected image to be adjusted from each corner to make a square image when the projection surface is not level.  
**Note:** *While adjusting the Four Corner, the Zoom, Aspect Ratio, and Image Shift menus are disabled. To enable Zoom, Aspect Ratio, and Image Shift, reset the Four Corner settings to the factory defaults.*
- **H Keystone:** Adjust image distortion horizontally and make a squarer image. Horizontal keystone is used to correct a keystone image shape in which the left and right borders of the image are unequal in length. This is intended for use with horizontally on-axis applications.
- **V Keystone:** Adjust image distortion vertically and make a squarer image. Vertical keystone is used to correct a keystone image shape in which the top and bottom are slanted to one of the sides. This is intended when for use with vertically on-axis applications.
- **Auto V Keystone:** Automatically correct vertical keystone error.
- **3x3 Warp:** Use 3x3 (9 correction points) Warping to adjust the image to align with the border of the projection surface (screen) or to eliminate image distortion (cause by an uneven surface).

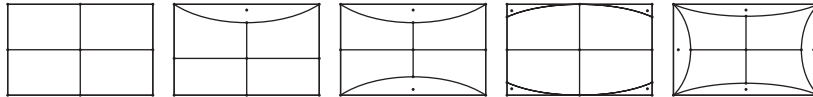

- **Reset:** Return the factory default settings for geometric connection.

**Note:** *When using Enhanced Game Mode, 4 Corner, Horizontal Keystone, Vertical Keystone, and 3x3 warping will be disabled as the settings impact input lag. If you plan to use Enhanced Game Mode for low input lag, we strongly recommend setting up the projector without the use for 4 Corner, Horizontal Keystone, Vertical Keystone, and 3x3 warping.*

# USING THE PROJECTOR

## Audio menu

### Audio Mode

Select the appropriate audio mode.

Audio Mode	Input Source
	HDMI1/HDMI2/HDMI3
Speaker/Audio out	PCM
SPDIF/eARC	<b>SPDIF/ARC:</b> PCM, Dolby Digital, DTS
	<b>eARC:</b> PCM, Dolby Digital/+, DTS-HD

#### **Note:**

- *The selected audio mode applies to all sources:*
- *The projector detects automatically Speaker / Audio Out mode.*
- *eARC function is supported with both HDMI1.*
- *If the current input audio format is not PCM, system will resync after audio mode has changed on the source device.*
- *If the audio output device does not support the input source audio format, then audio output will be abnormal.*

### Mute

Use this option to temporarily turn off the sound.

- **Off:** Choose “Off” to turn mute off.
- **On:** Choose “On” to turn mute on.

**Note:** Mute function affects both internal and external speaker volume.

### Volume

Adjust the volume level.

# USING THE PROJECTOR

## Setup menu

### Projection

Select the preferred projection between front, rear, ceiling-top, and rear-top.

### Power Settings

Configure power settings.

- **Direct Power On:** Choose “On” to activate Direct Power mode. The projector will automatically power on when AC power is supplied, without pressing the “Power” key on the projector keypad or on the remote control.
- **Signal Power Off:** Choose “On” to activate Signal Power mode. The projector will automatically power on when a signal is detected, without pressing the “Power” key on the projector Keypad or on the remote control.

**Note:**

- *This function is applicable with VGA and HDMI sources.*
- *Signal Power On can only be used for one HDMI port at a time. Signal Power On will not work if there is more than one source device connected to the projector. If more than one source device will be used with Signal Power On, please use a HDMI Switch.*
- **Auto Power Off (min):** Sets the countdown timer interval. The countdown timer will start, when there is no signal being sent to the projector. The projector will automatically power off when the countdown has finished (in minutes).
- **Sleep Timer (min.):** Configure the sleep timer.
  - Sleep Timer (min.): Sets the countdown timer interval. The countdown timer will start, with or without a signal being sent to the projector. The projector will automatically power off when the countdown has finished (in minutes).
- **Note:** *The Sleep Timer is reset every time when the projector is powered off.*
  - Always On: Check to set the sleep timer always on.
- **Power Mode (Standby):** Set the power mode setting.
  - Active: Choose “Active” to return to normal standby.
  - Eco: Choose “Eco.” to save power dissipation further < 0.5W.
- **USB Power (Standby):** Enable or disable the USB power function when the projector is in standby mode.

### Security

Configure security settings.

- **Security:** Enable this function to prompt for a password before using the projector.
  - Off: Choose “Off” to be able to switch on the projector without password verification.
  - On: Choose “On” to use security verification when the turning on the projector.
- **Note:** *The default password is 1234.*
- **Security Timer:** Can be select the time (Month/Day/Hour) function to set the number of hours the projector can be used. Once this time has elapsed you will be requested to enter your password again.
- **Change Password:** Use to set or modify the password that is prompted when turning the projector on.

# USING THE PROJECTOR

## HDMI Link Settings

**Note:** When you connect HDMI CEC-compatible devices to the projector with HDMI cables, you can control them on the same power on or power off status using the HDMI Link control feature in the projector's OSD. This lets one device or multiple devices in a group power on or power off via HDMI Link Feature in a typical configuration, your DVD player may be connected to the projector through an amplifier or home theater system.

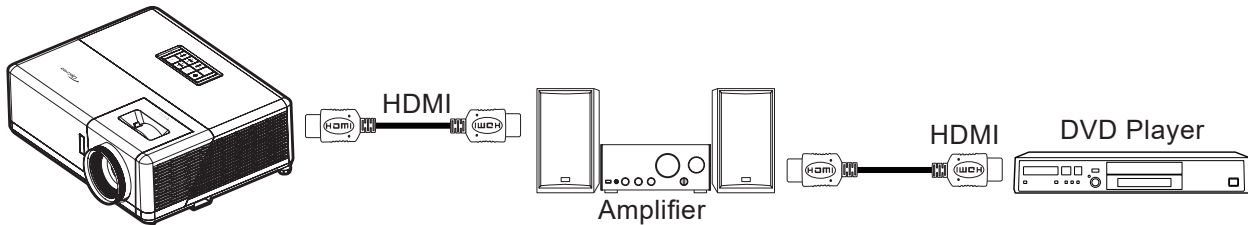

- **HDMI Link:** Enable/disable the HDMI Link function.
- **Inclusive of TV:** If the settings is set to “Yes” then the power on and power off link options are available.
- **Power On Link:** CEC power on command.
  - Mutual: Both projector and CEC device will be turned on simultaneously.
  - PJ → Device: The CEC device will be turned on only after the projector is switched on.
  - Device → PJ: The projector will be switched on only after the CEC device is turned on.
- **Power Off Link:** Enable this function to let both HDMI Link and projector to be automatically turned off at the same time.

## Test Pattern

Select the test pattern from green grid, magenta grid, white grid, white, or disable this function (off).

## Remote Settings

- **IR Function:** Set the IR function setting.
  - On: Choose “On”, the projector can be operated by the remote control from top and front IR receivers.
  - Off: Choose “Off”, the projector can't be operated by the remote control. By selecting “Off”, you will be able to use the Keypad keys.

## Projector ID

ID definition can be set up by menu (range 0-99), and allow user control an individual projector by using RS232 command.

## 12V Trigger

Use this function to enable or disable the trigger.

**Note:** 3.5mm mini jack that outputs 12V 500mA (max.) for relay system control.

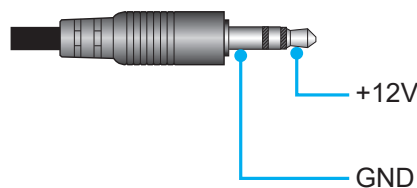

- **On:** Choose “On” to enable the trigger.
- **Off:** Choose “Off” to disable the trigger.

# USING THE PROJECTOR

## Options

Configure the projector options.

- **Language:** Select the multilingual OSD menu between English, German, French, Italian, Spanish, Portuguese, Traditional Chinese, Simplified Chinese, Japanese, Korean, and Russian.
- **Menu Settings:** Set the menu location on the screen and configure menu timer settings.
  - **Menu Location:** Select the menu location on the display screen.
  - **Menu Timer:** Set the duration where the OSD menu stays visible on the screen.
- **Auto Source:** Choose this option to let the projector automatically find an available input source.
- **Input Source:** Select the input source between HDMI1, HDMI2, and HDMI3.
- **Input Name:** Use to rename the input function for easier identification. The available options include HDMI1, HDMI2, and HDMI3.
- **High Altitude:** When “On” is selected, the fans will spin faster. This feature is useful in high altitude areas where the air is thin.
- **Display Mode Lock:** Choose “On” or “Off” to lock or unlock adjusting display mode settings.
- **Keypad Lock:** When the keypad lock function is “On”, the Keypad will be locked. However, the projector can be operated by the remote control. By selecting “Off”, you will be able to reuse the Keypad.
- **Information Hide:** Enable this function to hide the information message.
  - **Off:** Choose “Off” to show the “searching” message.
  - **On:** Choose “On” to hide the info message.
- **Logo:** Use this function to set the desired startup screen. If changes are made, they will take effect the next time the projector is powered on.
  - **Default:** The default startup screen.
  - **Neutral:** Logo is not displayed on startup screen.
- **Background:** Use this function to display a blue, red, green, gray color, logo, or none when no signal is available.

## Reset

Reset the projector.

- **Reset OSD:** Return the OSD menu settings to factory default.
- **Reset to Default:** Return all settings to factory default.

# USING THE PROJECTOR

## Info menu

View the projector information as listed below:

- Regulatory
- Serial Number
- Source
- Resolution
- Refresh Rate
- Display Mode
- Projector ID
- Brightness Mode
- FW Version

# ADDITIONAL INFORMATION

## Compatible resolutions

### Video compatibility

Signal	Resolution
SDTV	480p
HDTV	720p (50/60Hz), 1080i (50/60Hz), 1080p (24/50/60Hz)
UHD	2160p (24/50/60Hz)

Video timing in details:

Signal	Resolution	Refresh Rate (Hz)	Notes
SDTV(480p)	640 x 480	60	
HDTV(720p)	1280 x 720	50/60	
HDTV(1080I)	1920 x 1080	50/60	
HDTV(1080p)	1920 x 1080	24/50/60	
HDTV(1080p)	1920 x 1080	240	Only For HDMI1,HDMI2
WQHD(1440p)	2560 x 1440	120	
UHD(2160p)	3840 x 2160	24/50/60	For 4K UHD

### Computer compatibility

VESA standards (Computer Signal (Analog RGB compatibility)):

Signal	Resolution	Refresh Rate (Hz)	Notes for Mac
SVGA	800 x 600	56/60/72	Mac 60/72
XGA	1024 x 768	60/70/75	Mac 60/70/75
HDTV(720p)	1280 x 720	50/60	Mac 60
WXGA	1280 x 768	60/75	Mac 60/75
WXGA	1280 x 800	60	Mac 60
WXGA	1366 x 768	60	Mac 60
WXGA+	1440 x 900	60	Mac 60
SXGA	1280 x 1024	60/75	Mac 60/75
UXGA	1600 x 1200	60	
HDTV(1080p)	1920 x 1080	24/50/60	Mac 60
WUXGA	1920 x 1200 (*)	60	Mac 60

**Note:** (\*)1920 x 1200 @60Hz only supports RB(reduced blanking).



# ADDITIONAL INFORMATION

Timing table for PC:

Signal	Resolution	Frequency H.	Refresh Rate	Video	Digital	Note
		(KHz)	(Hz)			
SVGA	800 x 600	35.2	56.3	N/A	√	56Hz
SVGA	800 x 600	37.9	60.3	N/A	√	60Hz
SVGA	800 x 600	46.9	75	N/A	√	N/A
SVGA	800 x 600	48.1	72.2	N/A	√	72Hz
SVGA	800 x 600	53.7	85.1	N/A	√	85Hz
SVGA	832 x 624	N/A	75	N/A	√	N/A
XGA	1024 x 768	48.4	60	N/A	√	N/A
XGA	1024 x 768	56.5	70.1	N/A	√	70Hz
XGA	1024 x 768	60	75	N/A	√	N/A
XGA	1024 x 768	68.7	85	N/A	√	N/A
XGA	1024 x 768	N/A	120	N/A	N/A	N/A
SXGA	1152 x 864	N/A	75	N/A	√	N/A
HD720	1280 x 720	N/A	50	N/A	√	N/A
HD720	1280 x 720	N/A	60	N/A	√	N/A
HD720	1280 x 720	92.62	120	N/A	N/A	N/A
WXGA	1280 x 768	47.4	60	N/A	√	N/A
WXGA	1280 x 768	N/A	75	N/A	√	N/A
WXGA	1280 x 768	N/A	85	N/A	√	N/A
WXGA-800	1280 x 800	N/A	60	N/A	√	N/A
SXGA	1280 x 1024	64	60	N/A	√	N/A
SXGA	1280 x 1024	80	75	N/A	√	N/A
SXGA	1280 x 1024	91.1	85	N/A	√	N/A
SXGA+	1400 x 1050	N/A	60	N/A	N/A	N/A
UXGA	1600 x 1200	75	60	N/A	√	N/A
HD1080	1920 x 1080	N/A	24	N/A	√	N/A
HD1080	1920 x 1080	N/A	50	N/A	√	N/A
HD1080	1920 x 1080	N/A	60	N/A	√	N/A
WUXGA	1920 x 1200	N/A	60	N/A	√	RB
HDTV	1920 x 1080i	N/A	50	√	√	N/A
HDTV	1920 x 1080i	N/A	60	√	√	N/A
HDTV	1920 x 1080p	N/A	24	√	√	N/A
HDTV	1920 x 1080p	N/A	50	√	√	N/A
HDTV	1920 x 1080p	N/A	60	√	√	N/A
HDTV	1280 x 720	45	60	√	N/A	N/A
HDTV	1280 x 720p	N/A	50	√	√	N/A
HDTV	1280 x 720p	N/A	60	√	√	N/A
SDTV	720 x 480p	N/A	60	N/A	√	N/A

**Note:** “√” means the resolution is supported, “N/A” means the resolution is not supported.

# ADDITIONAL INFORMATION

## Computer Compatibility for MAC

Resolution	Hz	Macbook Compatibility	Macbook Pro (Intel) Compatibility	Power Mac G5 Compatibility	Power Mac G4 Compatibility
		Digital	Digital	Digital	Digital
800 x 600	60	√	√	N/A	√
800 x 600	72	√	√	N/A	√
800 x 600	75	√	√	N/A	√
800 x 600	85	√	N/A	N/A	√
1024 x 768	60	√	√	N/A	√
1024 x 768	70	√	√	N/A	√
1024 x 768	75	√	√	N/A	√
1024 x 768	85	√	√	N/A	√
1280 x 720	60	√	√	N/A	√
1280 x 768	60	√	√	N/A	N/A
1280 x 768	75	N/A	N/A	N/A	√
1280 x 768	85	N/A	N/A	N/A	N/A
1280 x 800	60	N/A	N/A	N/A	√
1280 x 1024	60	√	N/A	N/A	√
1280 x 1024	75	√	N/A	N/A	√
1920 x 1080	60	√	N/A	N/A	√
1920 x 1200 (*)	60	√	N/A	N/A	√
3840 x 2160	60	N/A	N/A	N/A	N/A

### Note:

- (\*) 1920 x 1200 @ 60Hz only supports RB (reduced blanking).
- “√” means the resolution is supported, “N/A” means the resolution is not supported.

## Input signal for HDMI

Signal	Resolution	Refresh Rate (Hz)	Notes for Mac
SVGA	800 x 600	60/72/85/120	Mac 60/72/85
XGA	1024 x 768	60/70/75/85/120	Mac 60/70/75/85
SDTV(480P)	640 x 480	60	
HDTV(720p)	1280 x 720	50/60	Mac 60
WXGA	1280 x 768	60/75/85	Mac 75
WXGA	1280 x 800	60/120	Mac 60
WXGA(*2)	1366 x 768	60	
WXGA+	1440 x 900	60/120(RB)	Mac 60
SXGA	1280 x 1024	60/75/85	Mac 60/75
SXGA+	1400 x 1050	60/85	
UXGA	1600 x 1200	60/65/70/75/85	
HDTV(1080i)	1920 x 1080	50/60	
HDTV(1080p)	1920 x 1080	24/30/50/60/120	Mac 60
HDTV(1080p)	1920 x 1080	240(*3)	Mac 60
WUXGA	1920 x 1200(*1)	60	Mac 60RB
WQHD	2560 x 1440	60RB/120	
UHD(2160p)	3840 x 2160	24/30/50/60	Mac 24/30
UHD(2160p)	4096 x 2160	24/30/50/60	Mac 24

# ADDITIONAL INFORMATION

## Note:

- (\*1) 1920 x 1200 @ 60Hz only supports RB(reduced blanking).
- (\*2) Windows 10 standard timing.
- (\*3) Only supported with HDMI1 and HDMI2.

## 3D Supported Timing

### HDMI1.4a 3D Timing for Blue-Ray 3D

Signal	Timing	Supported Port
720p (Frame Packing)	1280 x 720 @ 50Hz	HDMI1, HDMI2, HDMI3
720p (Frame Packing)	1280 x 720 @ 60Hz	HDMI1, HDMI2, HDMI3
1080p (Frame Packing)	1920 x 1080 @ 23.98/24Hz	HDMI1, HDMI2, HDMI3
720p (Top and Bottom)	1280 x 720 @ 50Hz	HDMI3
720p (Top and Bottom)	1280 x 720 @ 60Hz	HDMI3
1080p (Top and Bottom)	1920 x 1080 @ 23.98/24Hz	HDMI3
1080i(Side by Side(Half))	1920 x 1080 @ 50(25)Hz	HDMI3
1080i(Side by Side(Half))	1920 x 1080 @ 60(30)Hz	HDMI3

### PC 3D Timing

Signal	Timing	Supported Port
Frame Sequential	800 x 600 @ 120Hz	HDMI1, HDMI2, HDMI3
Frame Sequential	1024 x 768 @ 120Hz	HDMI1, HDMI2, HDMI3
Frame Sequential	1280 x 800 @ 120Hz	HDMI1, HDMI2, HDMI3
Frame Sequential	1920 x 1080 @ 120Hz	HDMI1, HDMI2, HDMI3

## Extended Display Identification Data (EDID) tables

### Digital signal (HDMI 2.0)

Digital Native resolution: 3840 x 2160 @ 60Hz

B0/Established Timing	B0/Standard Timing	B0/Standard Timing	B1/Video Mode	B1/Detail Timing
800 x 600 @ 56Hz	1280 x 720 @ 60Hz	3840 x 2160 @ 60Hz (default)	1920 x 1080p @ 120Hz 16:9	2560 x 1440 @ 120Hz
800 x 600 @ 72Hz	1280 x 800 @ 60Hz		720 x 480p @ 60Hz 4:3	1920 x 1080 @ 240Hz
800 x 600 @ 75Hz	1280 x 1024 @ 60Hz		1920 x 1080i @ 60Hz 16:9	
832 x 624 @ 75Hz	1920 x 1200 @ 60Hz		1920 x 1080i @ 50Hz 16:9	
1024 x 768 @ 60Hz	800 x 600 @ 120Hz		1920 x 1080p @ 60Hz 16:9	
1024 x 768 @ 70Hz	1024 x 768 @ 120Hz		1920 x 1080p @ 50Hz 16:9	
1024 x 768 @ 75Hz	1280 x 800 @ 120Hz		1920 x 1080p @ 24Hz 16:9	
1280 x 1024 @ 75Hz			3840 x 2160 @ 24Hz 16:9	
1152 x 870 @ 75Hz			3840 x 2160 @ 25Hz 16:9	
			3840 x 2160 @ 30Hz 16:9	
			3840 x 2160 @ 50Hz 16:9	
			3840 x 2160 @ 60Hz 16:9	
			4096 x 2160 @ 24Hz	
			4096 x 2160 @ 25Hz	
			4096 x 2160 @ 30Hz	
			4096 x 2160 @ 50Hz	

# ADDITIONAL INFORMATION

B0/Established Timing	B0/Standard Timing	B0/Standard Timing	B1/Video Mode	B1/Detail Timing
			4096 x 2160 @ 60Hz	
			720 x 480p @ 60Hz 16:9	
			1280 x 720p @ 60Hz 16:9	
			1280 x 720p @ 50Hz 16:9	
			720 x 576p @ 60Hz 16:9	

**Note:**

- Support 1920 x 1080 @ 50Hz.
- 1920 x 1080 @ 240Hz is supported only with HDMI1 and HDMI2.

# ADDITIONAL INFORMATION

## Image size and projection distance

Diagonal length (inch) size of 16:9 Screen	Screen Size W x H				Projection Distance (D)				Offset (Hd)	
	(m)		(inch)		(m)		(feet)		(m)	(feet)
	Width	Height	Width	Height	Wide	Tele	Wide	Tele		
30	0.66	0.37	26.15	14.71	-	1.1	-	43.4	0.02	0.06
50	1.11	0.62	43.58	24.51	1.7	1.8	65.4	72.3	0.03	0.10
60	1.33	0.75	52.29	29.42	2.0	2.2	78.4	86.8	0.04	0.12
75	1.66	0.93	65.37	36.77	2.5	2.8	98.1	108.5	0.05	0.15
90	1.99	1.12	78.44	44.12	3.0	3.3	117.7	130.2	0.06	0.18
100	2.21	1.25	87.16	49.03	3.3	3.7	130.7	144.7	0.06	0.20
120	2.66	1.49	104.59	58.83	4.0	4.4	156.9	173.6	0.07	0.25
150	3.32	1.87	130.74	73.54	5.0	5.5	196.1	217.0	0.09	0.31
180	3.98	2.24	156.88	88.25	6.0	6.6	235.3	260.4	0.11	0.37
210	4.65	2.62	183.03	102.95	7.0	7.7	274.5	303.8	0.13	0.43
300	6.64	3.74	261.47	147.08	10.0	-	392.2	-	0.19	0.61

**Note:** These values are not exact and can vary slightly.

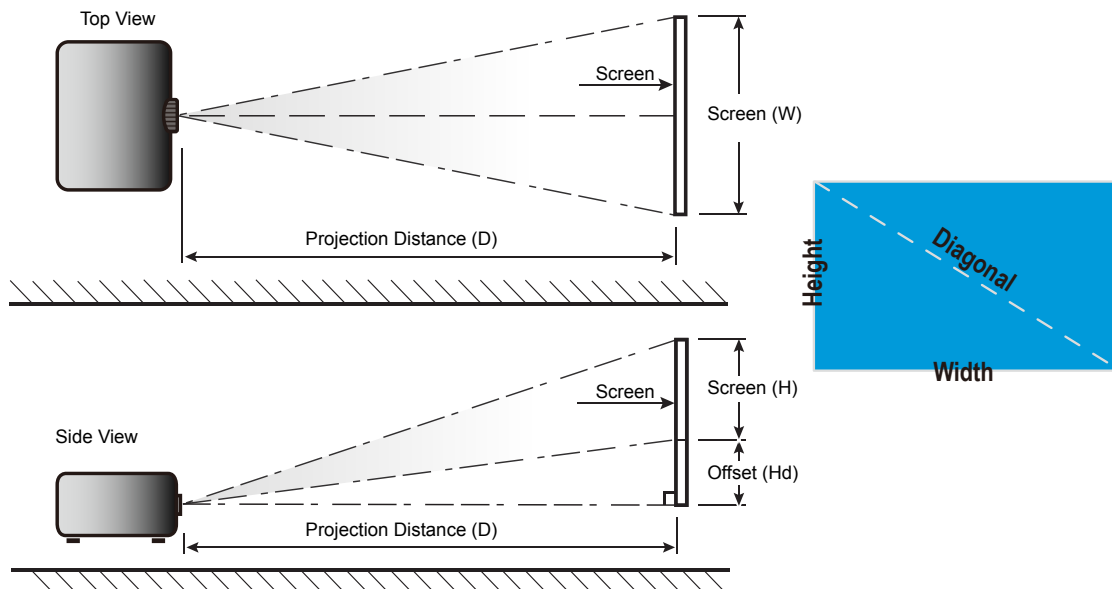

# ADDITIONAL INFORMATION

## Projector dimensions and ceiling mount installation

1. To prevent damage to your projector, please use the Optoma ceiling mount.
2. If you wish to use a third party ceiling mount kit, please ensure the screws used to attach a mount to the projector meet the following specifications:
  - Screw type: M4 for three point mounting
  - Minimum screw length: 10mm

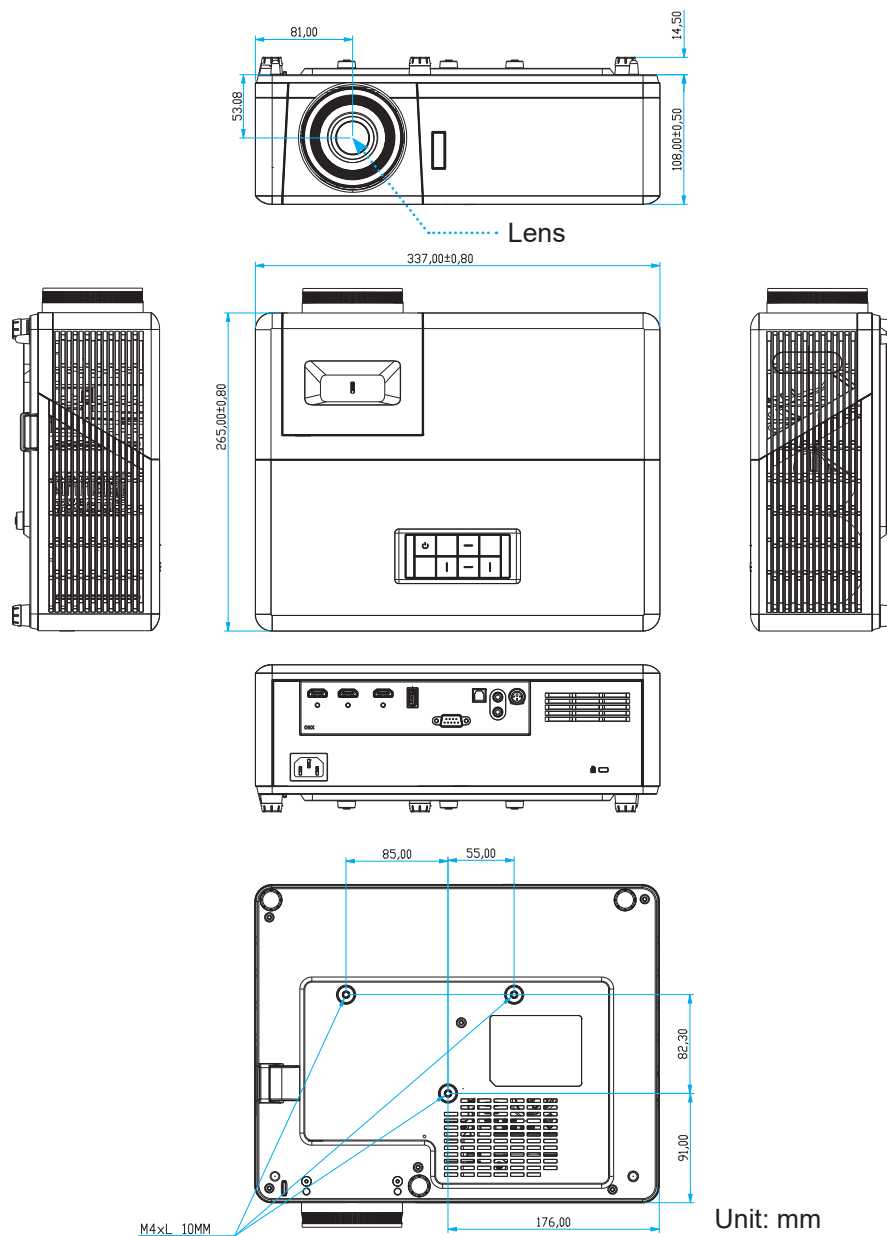

**Note:** Please note that damage resulting from incorrect installation will void the warranty.



Warning:

- If you buy a ceiling mount from another company, please be sure to use the correct screw size. Screw size will vary depending on the thickness of the mounting plate.
- Be sure to keep at least 10 cm gap between the ceiling and the bottom of the projector.
- Avoid installing the projector near a heat source.













# ADDITIONAL INFORMATION

## Remote control codes



Key	Custom code	Key Code				Description
		Byte 1	Byte 2	Byte 3	Byte 3	
Power on		32	CD	02	FD	Press to turn on the projector.
Source		32	CD	C3	3C	Press "Source" to select an input signal.
Backlight		N/A				Backlight toggle.
Re-sync		32	CD	C4	3B	Automatically synchronizes the projector to the input source.
Sleep Timer		32	CD	63	9C	Set the sleep timer interval.
Keystone		32	CD	7	F8	Adjust image distortion caused by tilting the projector.
Aspect Ratio		32	CD	64	9B	Press to change aspect ratio of a displayed image.
3D	<b>3D</b>	32	CD	89	76	Manually select a 3D mode that matches your 3D content.
Brightness		32	CD	41	BE	Adjust the brightness of the image.
Contrast		32	CD	42	BD	Control the degree of difference between the lightest and darkest parts of the picture.

# ADDITIONAL INFORMATION

Key		Custom code		Key Code		Description
		Byte 1	Byte 2	Byte 3	Byte 3	
Lamp		32	CD	0A	F5	Select the brightness mode.
CMS	CMS	32	CD	0B	F4	Open the Optoma Color Management System (CMS). (not supported)
Mode		32	CD	5	FA	Select a display mode for optimized settings for different applications. Please see page 27.
HDR	HDR	32	CD	0C	F3	Configure the (HDR) settings.
Four direction keys	^	32	CD	11	EE	Select items or make adjustments to your selection.
	v	32	CD	14	EB	
	<	32	CD	10	EF	
	>	32	CD	12	ED	
Enter		32	CD	0F	F0	Confirm your item selection.
Return		32	CD	0D	F2	Move to the previous menu.
Menu		32	CD	0E	F1	Display or exit the on-screen display menus for projector.
Vol -		32	CD	8F	70	Adjust to decrease volume.
Mute		32	CD	52	AD	Mute audio.
Vol +		32	CD	8C	73	Adjust to increase volume.
HDMI1	HDMI 1	32	CD	16	E9	Select HDMI1 input source.
HDMI2	HDMI 2	32	CD	30	CF	Select HDMI2 input source.
HDMI3	HDMI 3	32	CD	98	67	Select HDMI3 input source.
User1		32	CD	36	C9	Sleep timer.
User2		32	CD	65	9A	CMS.
User3		32	CD	66	99	No function.
User4		32	CD	09	F6	No function.



# ADDITIONAL INFORMATION

## Troubleshooting

If you experience a problem with your projector, please refer to the following information. If a problem persists, please contact your local reseller or service center.

### Image problems

- ❓ *No image appears on-screen*
  - Ensure all the cables and power connections are correctly and securely connected as described in the "Installation" section.
  - Ensure the pins of connectors are not crooked or broken.
  - Ensure that the "Mute" feature is not turned on.
  
- ❓ *Image is out of focus*
  - Adjust the Focus Ring on the projector lens. Please see page 17.
  - Make sure the projection screen is between the required distance from the projector. (Please refer to page 45).
  
- ❓ *The image is stretched when displaying 16:9 DVD title*
  - When you play anamorphic DVD or 16:9 DVD, the projector will show the best image in 16: 9 format on projector side.
  - If you play 4:3 format DVD title, please change the format as 4:3 in projector OSD.
  - Please setup the display format as 16:9 (wide) aspect ratio type on your DVD player.
  
- ❓ *Image is too small or too large*
  - Adjust the zoom lever on the top of the projector.
  - Move the projector closer to or further from the screen.
  - Press "Menu" on the projector panel, go to "Display-->Aspect Ratio". Try the different settings.
  
- ❓ *Image has slanted sides:*
  - If possible, reposition the projector so that it is centered on the screen and below the bottom of the screen.
  
- ❓ *Image is reversed*
  - Select "Setup-->Projection" from the OSD and adjust the projection direction.
  
- ❓ *Blurry double image*
  - Make sure "Display Mode" is not 3D to avoid normal 2D image appear blurry double image.

# ADDITIONAL INFORMATION

## Other problems



*The projector stops responding to all controls*

- If possible, turn off the projector, then unplug the power cord and wait at least 20 seconds before reconnecting power.

## Remote control problems



*If the remote control does not work*

- Check the operating angle of the remote control is pointed within  $\pm 15^\circ$  towards the top or front IR receivers on the projector.
- Make sure there are not any obstructions between the remote control and the projector. Move to within 6 m (~19 ft) of the projector.
- Make sure batteries are inserted correctly.
- Replace batteries if they are exhausted.

## Warning indicators

When the warning indicators (see below) light up or flash, the projector will automatically shutdown:

- "Light Source" LED indicator is lit red and if "On/Standby" indicator flashes red.
- "TEMP" LED indicator is lit red and if "On/Standby" indicator flashes red. This indicates the projector has overheated. Under normal conditions, the project can be switched back on.
- "TEMP" LED indicator flashes red and if "On/Standby" indicator flashes red.

Unplug the power cord from the projector, wait for 30 seconds and try again. If the warning indicator light up or flash, please contact your nearest service center for assistance.

# ADDITIONAL INFORMATION

## LED status lights

Message	On/Standby LED		Temp LED	Light Source LED
	(Red)	(Blue)	(Red)	(Red)
Standby state (Input power cord)	Steady light			
Power on (Warming)		Flashing (0.5 sec off / 0.5 sec on)		
Power on and light source lighting		Steady light		
Power off (Cooling)		Flashing (0.5 sec off / 0.5 sec on). Back to red steady light when cooling fan turns off.		
Error (Light source failure)	Flashing			Steady light
Error (Fan failure)	Flashing		Flashing	
Error (Over temp.)	Flashing		Steady light	
Standby State (Burn in mode)		Flashing		
Burn in (Warming)		Flashing		
Burn in (Cooling)		Flashing		
Burn in (Light source lighting)		Flashing (3 sec on / 1 sec off)		
Burn in (Light source off)		Flashing (1 sec on / 3 sec off)		

- Power off:

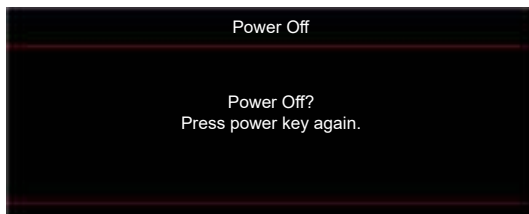

- Temperature warning:



# ADDITIONAL INFORMATION

- Fan failed:

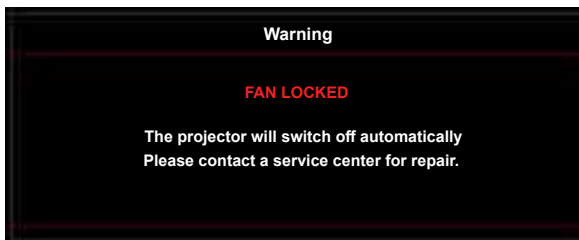

- Out of display range:

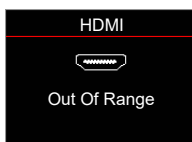

- Power down warning:

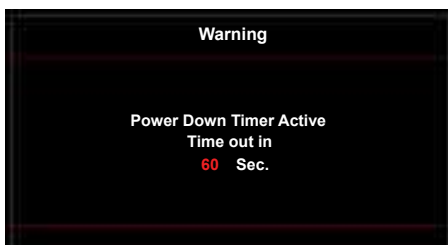

# ADDITIONAL INFORMATION

## Specifications

Optical	Description
Technology	Texas Instrument DMD, 0.47"/1080p UHD HSSI DMD X1, S451
Output resolution	1920 x 1080 (w/o actuator)
Maximum input resolution	Graphic up to 2160p@60Hz <ul style="list-style-type: none"> <li>• HDMI1 (2.0): 2160p@60Hz</li> <li>• HDMI2 (2.0): 2160p@60Hz</li> <li>• HDMI3 (2.0): 2160p@60Hz</li> </ul> Maximum Bandwidth: <ul style="list-style-type: none"> <li>• HDMI 2.0: 600MHz</li> <li>• HDMI 1.4: 600MHz (RB)</li> </ul>
Lens	<ul style="list-style-type: none"> <li>• Throw ratio: 1.5~1.66 (+/-3% tolerance)</li> <li>• F-stop: 1.98 (wide)~2.02 (tele)</li> <li>• Focal length: 15.84~17.44mm</li> <li>• Zoom ratio: 1.1x</li> </ul>
Offset	105% (+/-5% tolerance)
Image size	33"~300", optimized wide 80"
Projection distance	1.2m~9.9m
I/Os	<ul style="list-style-type: none"> <li>• HDMI V2.0 / HDCP2.2 (x3)</li> <li>• USB2.0 (for FW upgrade)</li> <li>• Audio Out 3.5mm</li> <li>• RS-232 male (9-pin D-SUB)</li> <li>• RJ-45 (Support IoT, Internet, and OTA functions)</li> <li>• S/PDIF (Supports PCM 2-channel, Dolby Digital (5.1))</li> <li>• 12V Trigger (3.5mm jack)</li> <li>• 3D Sync</li> </ul>
Colour	1073.4 Million color
Scan rate	<ul style="list-style-type: none"> <li>• Horizontal scan rate: 31.0~135.0 KHz</li> <li>• Vertical scan rate: 24~120 Hz</li> </ul>
Speaker	Yes, 8W
Power consumption	<ul style="list-style-type: none"> <li>• Brightness Mode: 100%               <ul style="list-style-type: none"> <li>• Typical 240W ±15% @ 110VAC BTU: 819</li> <li>• Typical 230W ±15% @ 220VAC BTU: 785</li> </ul> </li> <li>• Eco Mode: 80%               <ul style="list-style-type: none"> <li>• Typical 185W ±15% @ 110VAC BTU: 631</li> <li>• Typical 175W ±15% @ 220VAC BTU: 597</li> </ul> </li> </ul>
Power requirement	100 - 240V ±10%, AC 50/60Hz
Input current	3.0A
Installation orientations	Front, Rear, Ceiling-top, Rear-top
Dimensions (W x D x H)	<ul style="list-style-type: none"> <li>• Without feet: 337 x 265 x 108 mm (13.26 x 10.43 x 4.25 inches)</li> <li>• With feet: 337 x 265 x 119.3 mm (13.26 x 10.43 x 4.69 inches)</li> </ul>
Weight	4.8 kg (10.58 lbs)
Environmental	Operating in 0~40°C , 80% humidity (non-condensing)

**Note:** All specifications are subject to change without notice.



# ADDITIONAL INFORMATION

## Optoma global offices

For service or support, please contact your local office.



### USA

47697 Westinghouse Drive,  
Fremont, CA 94539, USA  
[www.optomausa.com](http://www.optomausa.com)

 888-289-6786  
 510-897-8601  
 [services@optoma.com](mailto:services@optoma.com)



### Canada

47697 Westinghouse Drive,  
Fremont, CA 94539, USA  
[www.optomausa.com](http://www.optomausa.com)

 888-289-6786  
 510-897-8601  
 [services@optoma.com](mailto:services@optoma.com)

### Latin America

47697 Westinghouse Drive,  
Fremont, CA 94539, USA  
[www.optomausa.com](http://www.optomausa.com)

 888-289-6786  
 510-897-8601  
 [services@optoma.com](mailto:services@optoma.com)



### Europe

Unit 1, Network 41, Bourne End Mills  
Hemel Hempstead, Herts,  
HP1 2UJ, United Kingdom  
[www.optoma.eu](http://www.optoma.eu)  
Service Tel : +44 (0)1923 691865

 +44 (0) 1923 691 800  
 +44 (0) 1923 691 888  
 [service@tsc-europe.com](mailto:service@tsc-europe.com)



### Benelux BV

Randstad 22-123  
1316 BW Almere  
The Netherlands  
[www.optoma.nl](http://www.optoma.nl)

 +31 (0) 36 820 0252  
 +31 (0) 36 548 9052



### France

Bâtiment E  
81-83 avenue Edouard Vaillant  
92100 Boulogne Billancourt, France

 +33 1 41 46 12 20  
 +33 1 41 46 94 35  
 [savoptoma@optoma.fr](mailto:savoptoma@optoma.fr)



### Spain

C/ José Hierro,36 Of. 1C  
28522 Rivas VaciaMadrid,  
Spain

 +34 91 499 06 06  
 +34 91 670 08 32



### Deutschland

Wiesenstrasse 21 W  
D40549 Düsseldorf,  
Germany

 +49 (0) 211 506 6670  
 +49 (0) 211 506 66799  
 [info@optoma.de](mailto:info@optoma.de)

### Scandinavia



Lerpeveien 25  
3040 Drammen  
Norway

 +47 32 98 89 90  
 +47 32 98 89 99  
 [info@optoma.no](mailto:info@optoma.no)

PO.BOX 9515  
3038 Drammen  
Norway

### China

Room 2001, 20F, Building 4,  
No.1398 Kaixuan Road,  
Changning District, Shanghai

 +86-21-62947376  
 +86-21-62947375  
[www.optoma.com.cn](http://www.optoma.com.cn)

### Korea

<https://www.optoma.com/kr/>

### Japan

<https://www.optoma.com/jp/>

### Taiwan

<https://www.optoma.com/tw/>

