



DLP® Projector

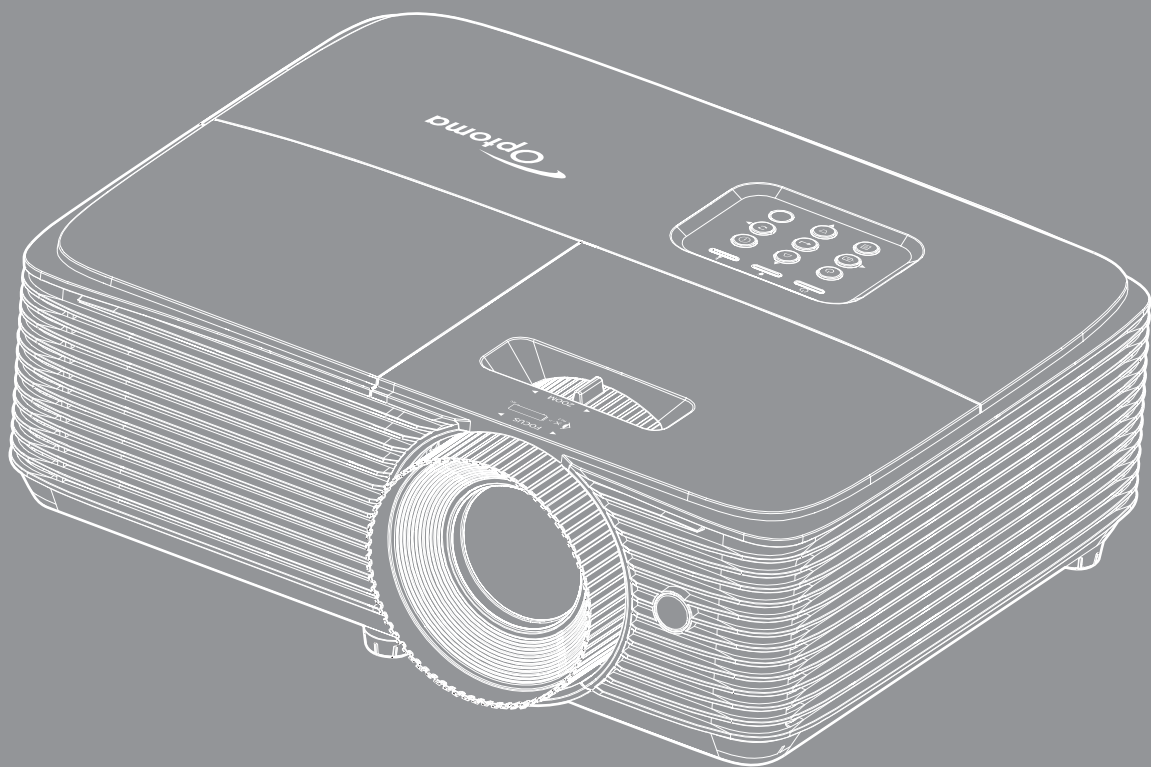

TABLE OF CONTENTS

SAFETY	4
<i>Important Safety Instruction.....</i>	<i>4</i>
<i>3D Safety Information.....</i>	<i>5</i>
<i>Copyright.....</i>	<i>6</i>
<i>Disclaimer.....</i>	<i>6</i>
<i>Trademark Recognition</i>	<i>6</i>
<i>FCC</i>	<i>7</i>
<i>Declaration of Conformity for EU countries</i>	<i>7</i>
<i>WEEE.....</i>	<i>7</i>
INTRODUCTION.....	8
<i>Package Overview.....</i>	<i>8</i>
<i>Standard accessories.....</i>	<i>8</i>
<i>Optional accessories.....</i>	<i>8</i>
<i>Product Overview</i>	<i>9</i>
<i>Connections.....</i>	<i>10</i>
<i>Keypad</i>	<i>11</i>
<i>Remote control.....</i>	<i>12</i>
SETUP AND INSTALLATION.....	13
<i>Installing the projector</i>	<i>13</i>
<i>Connecting sources to the projector.....</i>	<i>15</i>
<i>Adjusting the projector image.....</i>	<i>16</i>
USING THE PROJECTOR.....	19
<i>Powering on / off the projector.....</i>	<i>19</i>
<i>Selecting an input source</i>	<i>20</i>
<i>Menu navigation and features</i>	<i>21</i>
<i>OSD Menu tree.....</i>	<i>22</i>
<i>Display image settings menu.....</i>	<i>29</i>
<i>Display enhanced gaming menu</i>	<i>30</i>
<i>Display 3D menu</i>	<i>31</i>
<i>Display aspect ratio menu</i>	<i>32</i>
<i>Display edge mask menu</i>	<i>33</i>
<i>Display zoom menu.....</i>	<i>33</i>
<i>Display image shift menu</i>	<i>33</i>
<i>Display keystone menu</i>	<i>33</i>
<i>Audio mute menu</i>	<i>34</i>
<i>Audio volume menu.....</i>	<i>34</i>
<i>Setup projection menu.....</i>	<i>34</i>
<i>Setup lamp settings menu.....</i>	<i>34</i>
<i>Setup filter settings menu.....</i>	<i>34</i>
<i>Setup power settings menu.....</i>	<i>35</i>

<i>Setup security menu</i>	36
<i>Setup HDMI link settings menu</i>	36
<i>Setup test pattern menu</i>	37
<i>Setup remote settings menu</i>	37
<i>Setup 12V trigger menu</i>	37
<i>Setup options menu</i>	37
<i>Setup reset menu</i>	38
<i>Info menu</i>	39



MAINTENANCE 40

<i>Replacing the lamp</i>	40
<i>Installing and cleaning the dust filter</i>	42

ADDITIONAL INFORMATION 43

<i>Compatible resolutions</i>	43
<i>Image size and projection distance</i>	44
<i>Projector dimensions and ceiling mount installation</i>	45
<i>IR remote control codes</i>	46
<i>Troubleshooting</i>	48
<i>Warning indicators</i>	50
<i>Specifications</i>	52
<i>Optoma global offices</i>	53

SAFETY

	The lightning flash with arrow head within an equilateral triangle is intended to alert the user to the presence of uninsulated "dangerous voltage" within the product's enclosure that may be of sufficient magnitude to constitute a risk of electric shock to persons.
	The exclamation point within an equilateral triangle is intended to alert the user to the presence of important operating and maintenance (servicing) instructions in the literature accompanying the appliance.

Please follow all warnings, precautions and maintenance as recommended in this user's guide.

Important Safety Instruction



- Do not stare into the beam, RG2.
As with any bright source, do not stare into the direct beam, RG2 IEC 62471-5:2015.
- Do not block any ventilation openings. To ensure reliable operation of the projector and to protect from over heating, it is recommended to install the projector in a location that does not block ventilation. As an example, do not place the projector on a crowded coffee table, sofa, bed, etc. Do not put the projector in an enclosure such as a book case or a cabinet that restricts air flow.
- To reduce the risk of fire and/or electric shock, do not expose the projector to rain or moisture. Do not install near heat sources such as radiators, heaters, stoves or any other apparatus such as amplifiers that emits heat.
- Do not let objects or liquids enter the projector. They may touch dangerous voltage points and short out parts that could result in fire or electric shock.
- Do not use under the following conditions:
 - In extremely hot, cold or humid environments.
 - (i) Ensure that the ambient room temperature is within 5°C ~ 40°C
 - (ii) Relative humidity is 10% ~ 85%
 - In areas susceptible to excessive dust and dirt.
 - Near any appliance generating a strong magnetic field.
 - In direct sunlight.
- Do not use the projector in places where flammable gases or explosives gases may be present in the atmosphere. The lamp inside the projector becomes very hot during operation and the gases may ignite and result in a fire.
- Do not use the unit if it has been physically damaged or abused. Physical damage/abuse would be (but not limited to):
 - Unit has been dropped.
 - Power supply cord or plug has been damaged.
 - Liquid has been spilled on to the projector.
 - Projector has been exposed to rain or moisture.
 - Something has fallen in the projector or something is loose inside.
- Do not place the projector on an unstable surface. The projector may fall over resulting in injury or the projector may become damaged.
- Do not block the light coming out of the projector lens when in operation. The light will heat the object and could melt, cause burns or start a fire.

- Please do not open or disassemble the projector as this may cause electric shock.
- Do not attempt to service the unit yourself. Opening or removing covers may expose you to dangerous voltages or other hazards. Please call Optoma before you send the unit for repair.
- See projector enclosure for safety related markings.
- The unit should only be repaired by appropriate service personnel.
- Only use attachments/accessories specified by the manufacturer.
- Do not look into straight into the projector lens during operation. The bright light may harm your eyes.
- When replacing the lamp, please allow the unit to cool down. Follow instructions as described on pages 40-41.
- This projector will detect the life of the lamp itself. Please be sure to change the lamp when it shows warning messages.
- Reset the "Lamp Reset" function from the on-screen display "Setup lamp settings" menu after replacing the lamp module.
- When switching the projector off, please ensure the cooling cycle has been completed before disconnecting power. Allow 90 seconds for the projector to cool down.
- When the lamp is approaching to the end of its life time, the message "Lamp life exceeded." will show on the screen. Please contact your local reseller or service center to change the lamp as soon as possible.
- Turn off and unplug the power plug from the AC outlet before cleaning the product.
- Use a soft dry cloth with mild detergent to clean the display housing. Do not use abrasive cleaners, waxes or solvents to clean the unit.
- Disconnect the power plug from AC outlet if the product is not being used for a long period of time.

Note: *When the lamp reaches the end of its life, the projector will not turn back on until the lamp module has been replaced. To replace the lamp, follow the procedures listed under "Replacing the Lamp" section on pages 40-41.*

- *Do not setup the projector in places where it might be subjected to vibration or shock.*
- *Do not touch the lens with bare hands.*
- *Remove battery/batteries from remote control before storage. If the battery/batteries are left in the remote for long periods, they may leak.*
- *Do not use or store the projector in places where smoke from oil or cigarettes may be present, as it can adversely affect the quality of the projector performance.*
- *Please follow the correct projector orientation installation as non standard installation may affect the projector performance.*
- *Use a power strip and or surge protector. As power outages and brown-outs can KILL devices.*

3D Safety Information

Please follow all warnings and precautions as recommended before you or your child use the 3D function.

Warning

Children and teenagers may be more susceptible to health issues associated with viewing in 3D and should be closely supervised when viewing these images.

Photosensitive Seizure Warning and Other Health Risks

- Some viewers may experience an epileptic seizure or stroke when exposed to certain flashing images or lights contained in certain Projector pictures or video games. If you suffer from, or have a family history of epilepsy or strokes, please consult with a medical specialist before using the 3D function.
- Even those without a personal or family history of epilepsy or stroke may have an undiagnosed condition that can cause photosensitive epileptic seizures.
- Pregnant women, the elderly, sufferers of serious medical conditions, those who are sleep deprived or under the influence of alcohol should avoid utilizing the unit's 3D functionality.

- If you experience any of the following symptoms, stop viewing 3D pictures immediately and consult a medical specialist: (1) altered vision; (2) light-headedness; (3) dizziness; (4) involuntary movements such as eye or muscle twitching; (5) confusion; (6) nausea; (7) loss of awareness; (8) convulsions; (9) cramps; and/ or (10) disorientation. Children and teenagers may be more likely than adults to experience these symptoms. Parents should monitor their children and ask whether they are experiencing these symptoms.
- Watching 3D projection may also cause motion sickness, perceptual after effects, disorientation, eye strain and decreased postural stability. It is recommended that users take frequent breaks to lessen the potential of these effects. If your eyes show signs of fatigue or dryness or if you have any of the above symptoms, immediately discontinue use of this device and do not resume using it for at least thirty minutes after the symptoms have subsided.
- Watching 3D projection while sitting too close to the screen for an extended period of time may damage your eyesight. The ideal viewing distance should be at least three times the screen height. It is recommended that the viewer's eyes are level with the screen.
- Watching 3D projection while wearing 3D glasses for an extended period of time may cause a headache or fatigue. If you experience a headache, fatigue or dizziness, stop viewing the 3D projection and rest.
- Do not use the 3D glasses for any other purpose than for watching 3D projection.
- Wearing the 3D glasses for any other purpose (as general spectacles, sunglasses, protective goggles, etc.) may be physically harmful to you and may weaken your eyesight.
- Viewing in 3D projection may cause disorientation for some viewers. Accordingly, DO NOT place your 3D PROJECTOR near open stairwells, cables, balconies, or other objects that can be tripped over, run into, knocked down, broken or fallen over.

Copyright

This publication, including all photographs, illustrations and software, is protected under international copyright laws, with all rights reserved. Neither this manual, nor any of the material contained herein, may be reproduced without written consent of the author.

© Copyright 2017

Disclaimer

The information in this document is subject to change without notice. The manufacturer makes no representations or warranties with respect to the contents hereof and specifically disclaims any implied warranties of merchantability or fitness for any particular purpose. The manufacturer reserves the right to revise this publication and to make changes from time to time in the content hereof without obligation of the manufacturer to notify any person of such revision or changes.

Trademark Recognition

Kensington is a U.S. registered trademark of ACCO Brand Corporation with issued registrations and pending applications in other countries throughout the world.

HDMI, the HDMI Logo, and High-Definition Multimedia Interface are trademarks or registered trademarks of HDMI Licensing LLC in the United States and other countries.

DLP®, DLP Link and the DLP logo are registered trademarks of Texas Instruments and BrilliantColor™ is a trademark of Texas Instruments.

All other product names used in this manual are the properties of their respective owners and are Acknowledged.

DARBEE is a trademark by Darbee Products, Inc.

MHL, Mobile High-Definition Link and the MHL Logo are trademarks or registered trademarks of MHL Licensing, LLC.

FCC

This device has been tested and found to comply with the limits for a Class B digital device pursuant to Part 15 of the FCC rules. These limits are designed to provide reasonable protection against harmful interference in a residential installation. This device generates, uses and can radiate radio frequency energy and, if not installed and used in accordance with the instructions, may cause harmful interference to radio communications.

However, there is no guarantee that interference will not occur in a particular installation. If this device does cause harmful interference to radio or television reception, which can be determined by turning the device off and on is encouraged to try to correct the interference by one or more of the following measures:

- Reorient or relocate the receiving antenna.
- Increase the separation between the device and receiver.
- Connect the device into an outlet on a circuit different from that to which the receiver is connected.
- Consult the dealer or an experienced radio/television technician for help.

Notice: Shielded cables

All connections to other computing devices must be made using shielded cables to maintain compliance with FCC regulations.

Caution

Changes or modifications not expressly approved by the manufacturer could void the user's authority, which is granted by the Federal Communications Commission, to operate this projector.

Operation Conditions

This device complies with Part 15 of the FCC Rules. Operation is subject to the following two conditions:

1. This device may not cause harmful interference and
2. This device must accept any interference received, including interference that may cause undesired operation.

Notice: Canadian users

This Class B digital apparatus complies with Canadian ICES-003.

Remarque à l'intention des utilisateurs canadiens

Cet appareil numérique de la classe B est conforme à la norme NMB-003 du Canada.

Declaration of Conformity for EU countries

- EMC Directive 2014/30/EU (including amendments)
- Low Voltage Directive 2014/35/EU
- RED 2014/53/EU (if product has RF function)

WEEE



Disposal instructions

Do not throw this electronic device into the trash when discarding. To minimize pollution and ensure utmost protection of the global environment, please recycle it.

INTRODUCTION

Package Overview

Carefully unpack and verify that you have the items listed below under standard accessories. Some of the items under optional accessories may not be available depending on the model, specification and your region of purchase. Please check with your place of purchase. Some accessories may vary from region to region.

The warranty card is only supplied in some specific regions. Please consult your dealer for detailed information.

Standard accessories

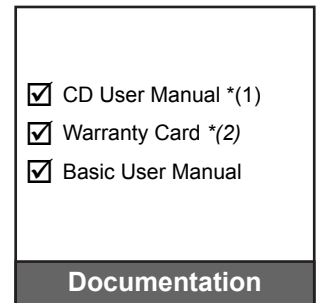
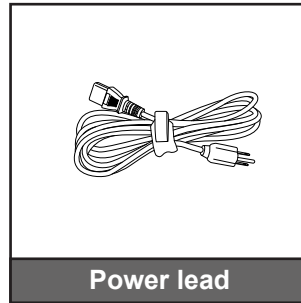
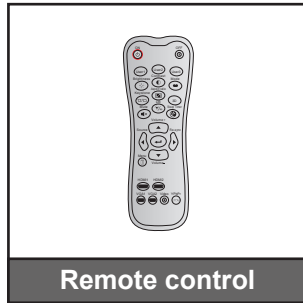
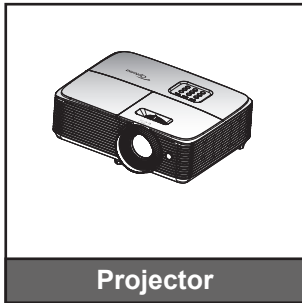

Note:

- The remote control is shipped with the battery.
- *(1) For European User Manual please visit www.optomaeurope.com.
- *(2) For European warranty information please visit www.optomaeurope.com.

Optional accessories

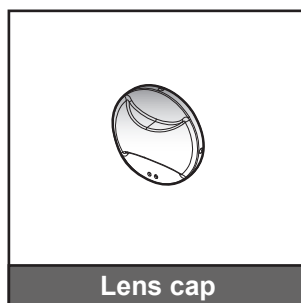
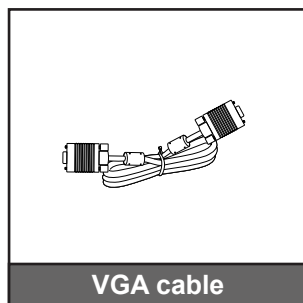

Note: Optional accessories vary depending on model, specification and region.

INTRODUCTION

Product Overview

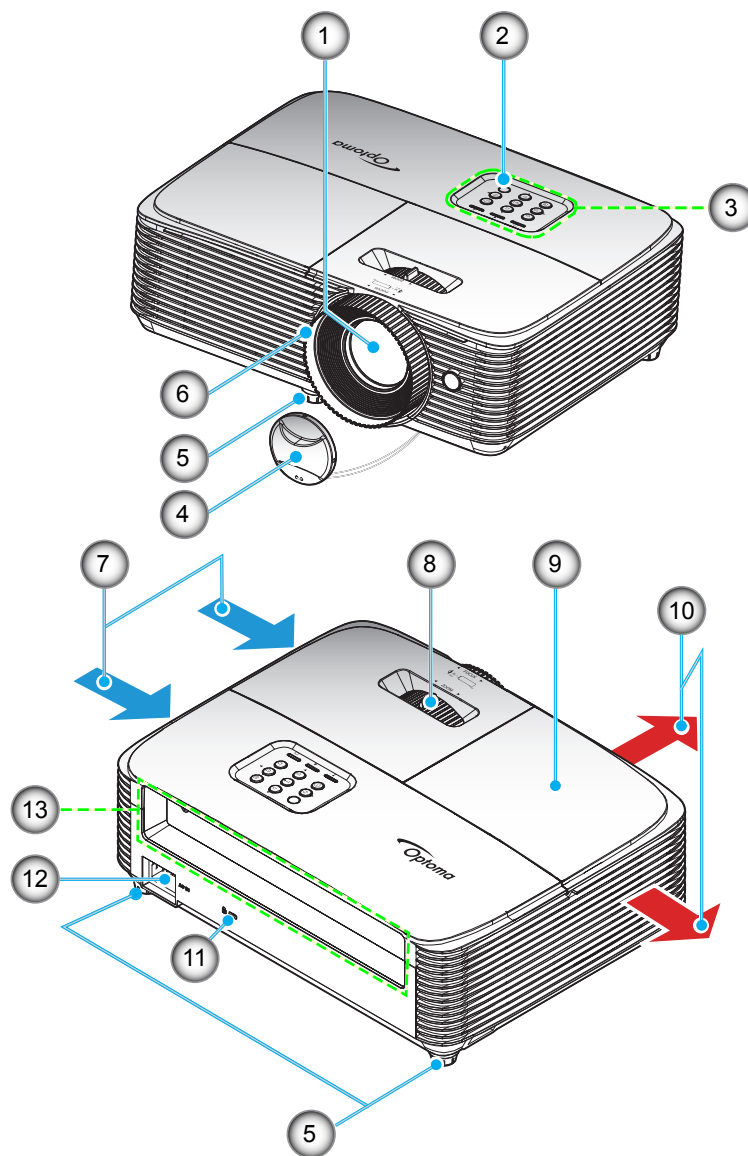

Note: Keep a minimum distance of 20 cm between the “inlet” and “outlet” labels.

No	Item	No	Item
1.	Lens	8.	Zoom Lever
2.	IR Receiver	9.	Lamp Cover
3.	Keypad	10.	Ventilation (outlet)
4.	Lens Cap	11.	Kensington™ Lock Port
5.	Tilt-Adjustment Foot	12.	Power Socket
6.	Focus Ring	13.	Input / Output
7.	Ventilation (inlet)		

INTRODUCTION

Connections

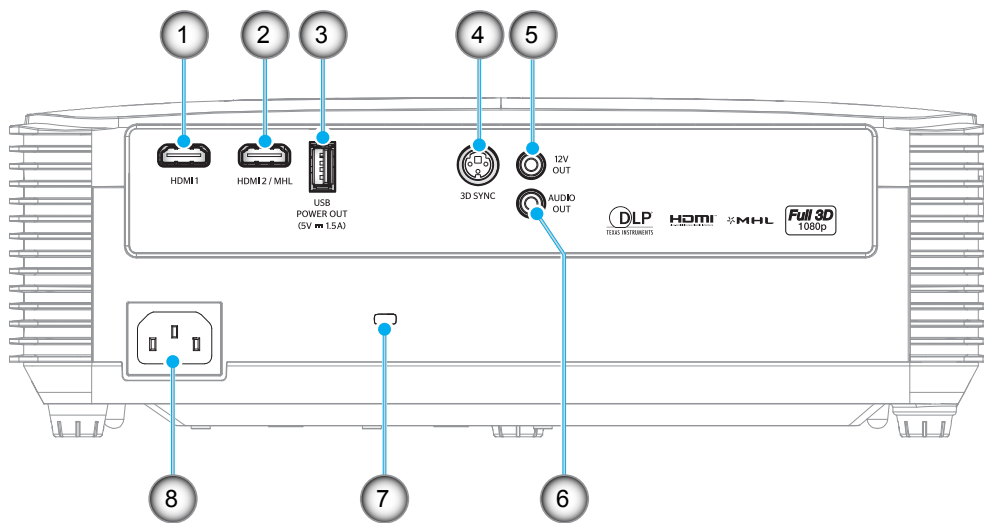

No	Item	No	Item
1.	HDMI Connector	5.	12V OUT Connector
2.	HDMI 2 / MHL Connector	6.	AUDIO OUT Connector
3.	USB Power Out (5V 1A) Connector / MOUSE / SERVICE Connector	7.	Kensington™ Lock Port
4.	3D SYNC OUT Connector	8.	Power Socket

Note: Remote mouse requires special remote control.

INTRODUCTION

Keypad

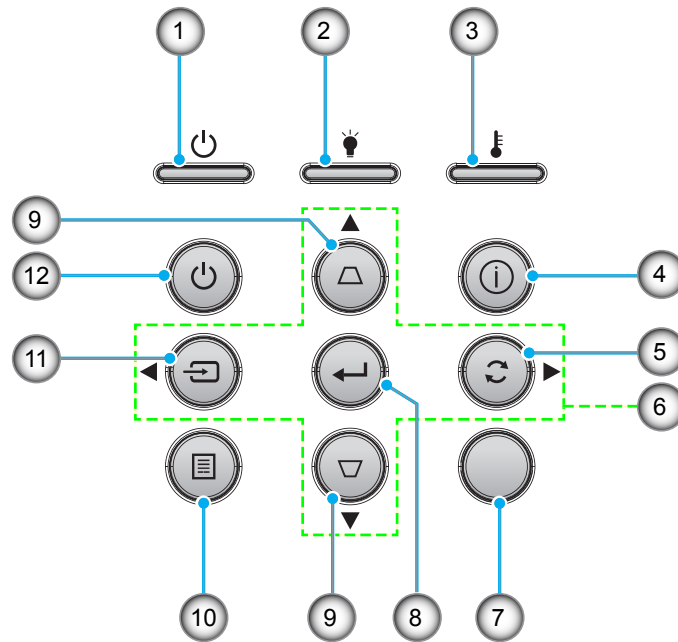

No	Item	No	Item
1.	On/Standby LED	7.	IR Receiver
2.	Lamp LED	8.	Enter
3.	Temp LED	9.	Keystone Correction
4.	Information	10.	Menu
5.	Re-Sync	11.	Source
6.	Four Directional Select Keys	12	Power

INTRODUCTION

Remote control

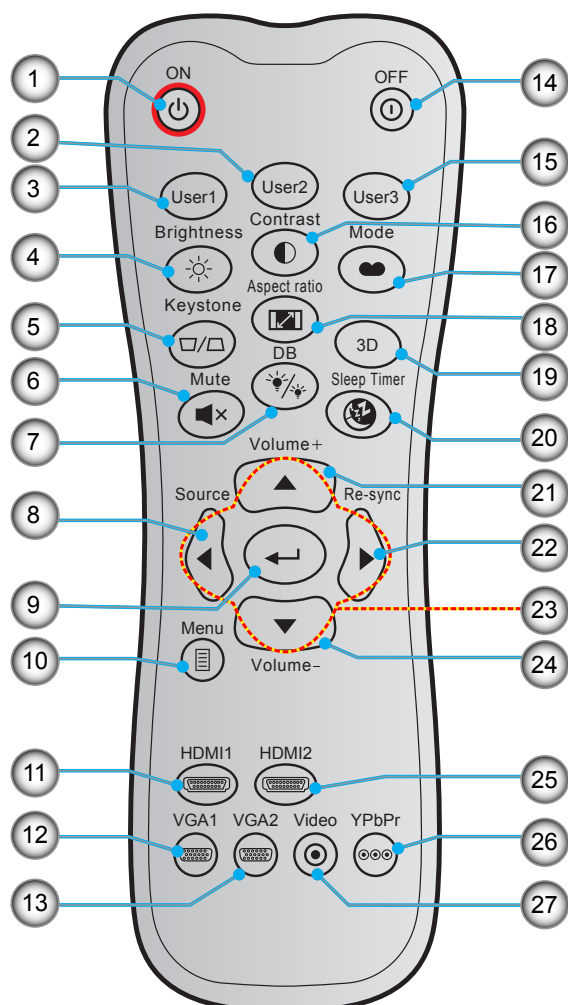

No	Item	No	Item
1.	Power On	15.	User 3
2.	User 2	16.	Contrast
3.	User 1	17.	Display Mode
4.	Brightness	18.	Aspect Ratio
5.	Keystone	19.	3D Menu On / Off
6.	Mute	20.	Sleep Timer
7.	DB (Dynamic Black)	21.	Volume +
8.	Source	22.	Re-Sync
9.	Enter	23.	Four Directional Select Keys
10.	Menu	24.	Volume -
11.	HDMI1	25.	HDMI2
12.	VGA1 (not supported)	26.	YPbPr (not supported)
13.	VGA2 (not supported)	27.	Video (not supported)
14.	Power Off		

Note: Some keys may have no function for models that do not support these features.

SETUP AND INSTALLATION

Installing the projector

Your projector is designed to be installed in one of four possible positions.

Your room layout or personal preference will dictate which installation location you select. Take into consideration the size and position of your screen, the location of a suitable power outlet, as well as the location and distance between the projector and the rest of your equipment.

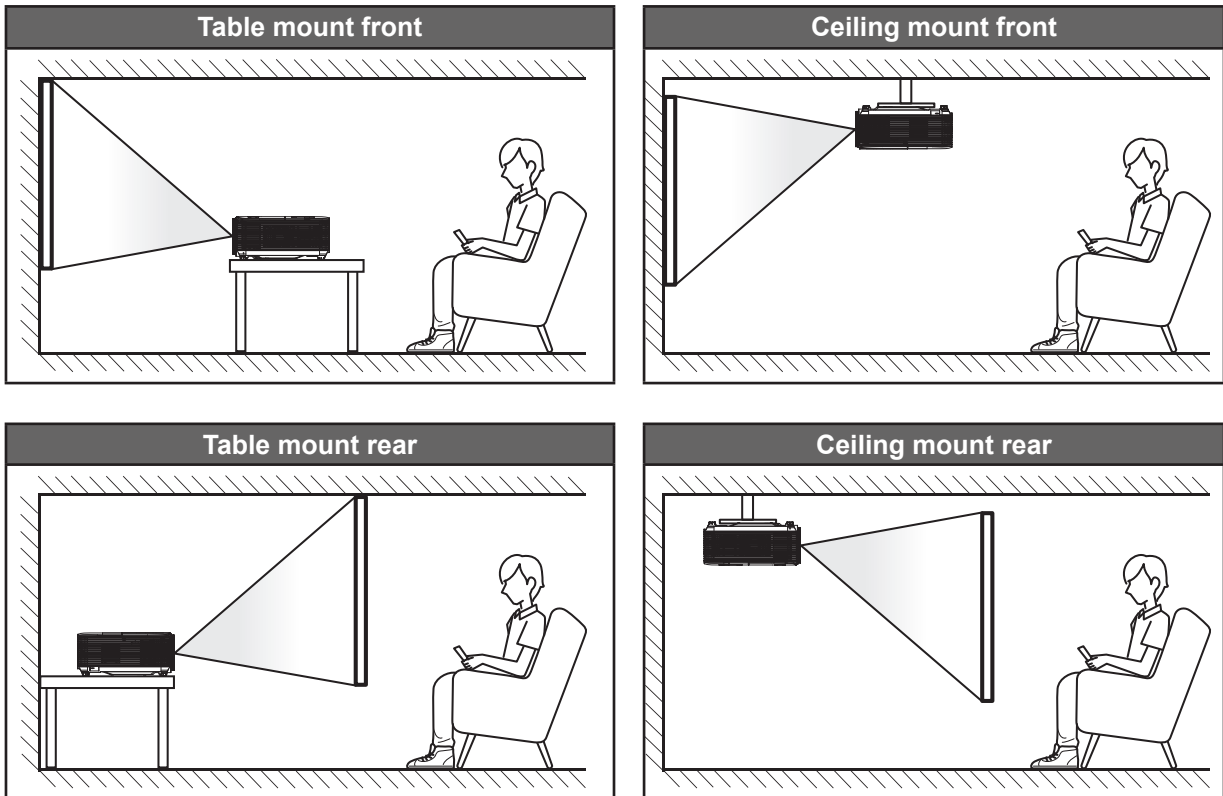

Projector should be placed flat on a surface and 90 degrees / perpendicular to the screen.

- How to determine projector location for a given screen size, please refer to distance table on page 44.
- How to determine screen size for a given distance, please refer to distance table on page 44.

Note: *The further away the projector is placed from the screen the projected image size increases and vertical offset also increases proportionally.*

IMPORTANT!

Do not operate the projector in any orientation other than table top or ceiling mount. The projector should be horizontal and not tilted either forwards/backwards or left/right. Any other orientation will invalidate the warranty and may shorten the lifetime of the projector lamp or the projector itself. For non standard installation advise please contact Optoma.

SETUP AND INSTALLATION

Projector installation notice

- Place the projector in a horizontal position.
The tilt angle of the projector should not exceed 15 degrees, nor should the projector be installed in any way other than the desktop and ceiling mount, otherwise lamp life could decrease dramatically, and may lead to other **unpredictable damages**.



- Allow at least 30 cm clearance around the exhaust vent.

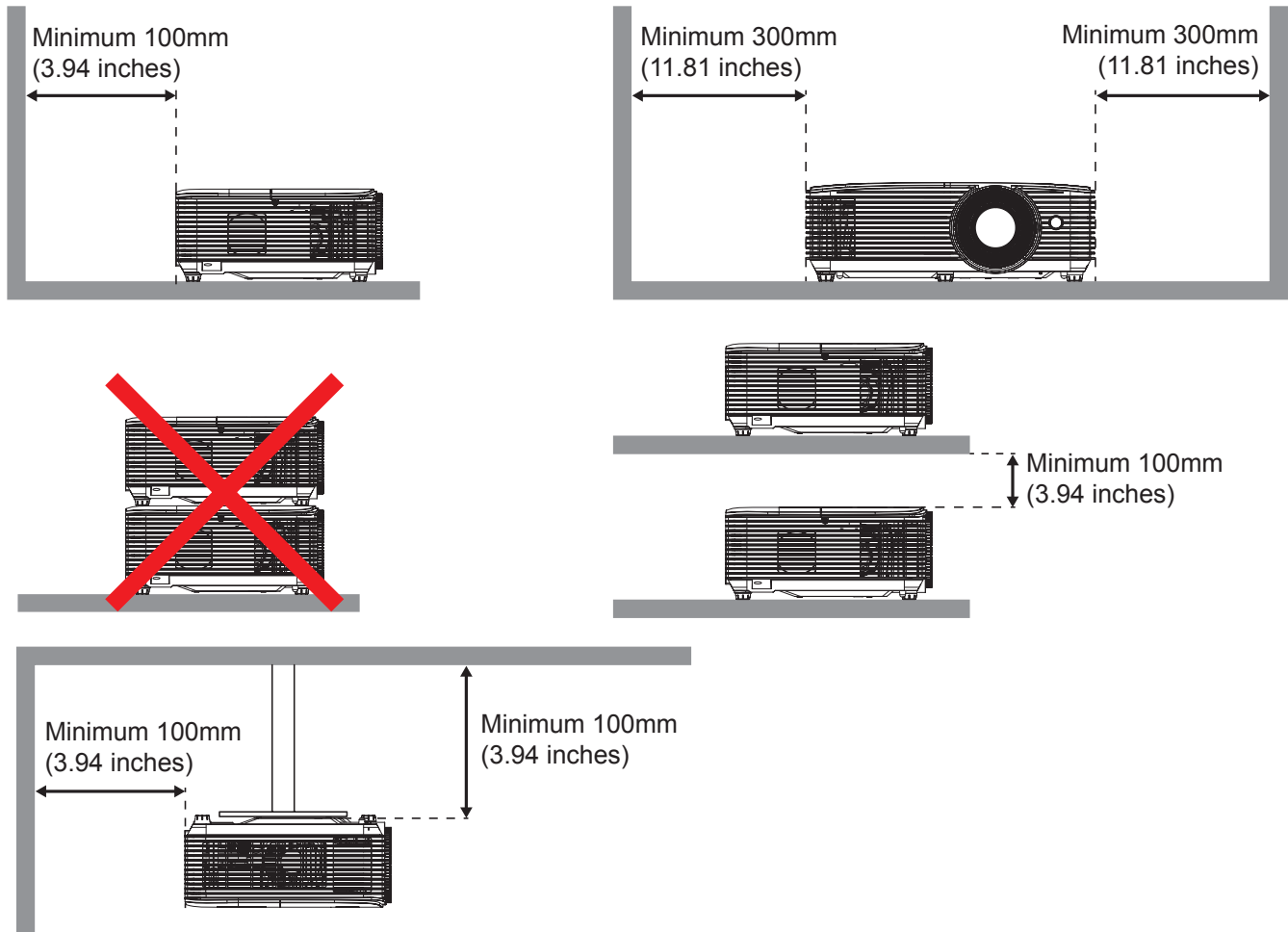

- Ensure that the intake vents do not recycle hot air from the exhaust vent.
- When operating the projector in an enclosed space, ensure that the surrounding air temperature within the enclosure does not exceed operation temperature while the projector is running, and the air intake and exhaust vents are unobstructed.
- All enclosures should pass a certified thermal evaluation to ensure that the projector does not recycle exhaust air, as this may cause the device to shutdown even if the enclosure temperature is within the acceptable operation temperature range.

SETUP AND INSTALLATION

Connecting sources to the projector

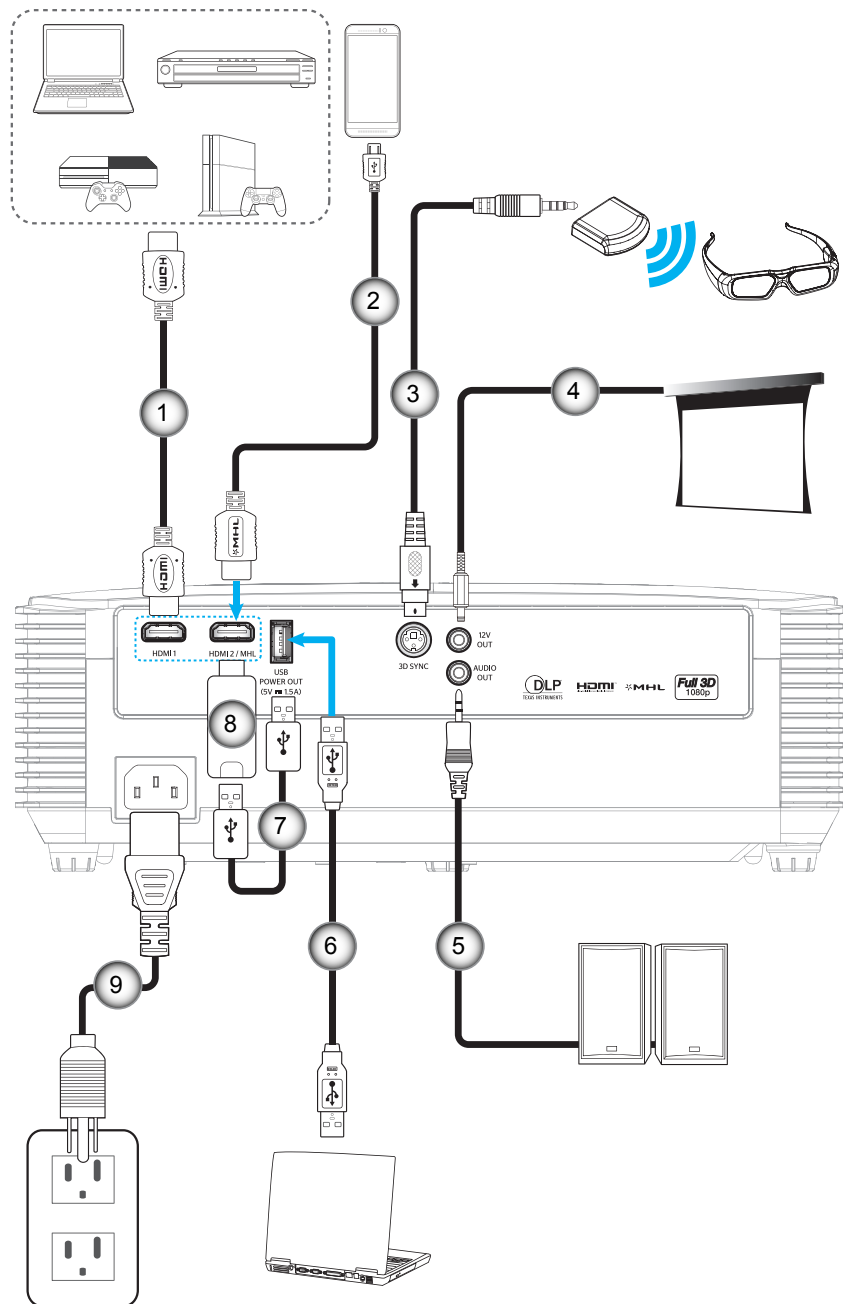

No	Item	No	Item
1.	HDMI Cable	6.	USB Cable
2.	HDMI / MHL Cable	7.	USB Power Cable
3.	3D Emitter Cable	8.	HDMI Dongle
4.	12V DC Jack	9.	Power Cord
5.	Audio Out Cable		

SETUP AND INSTALLATION

Adjusting the projector image

Image height

The projector is equipped with elevator feet for adjusting the image height.

1. Locate the adjustable foot you wish to adjust on the underside of the projector.
2. Rotate the adjustable foot clockwise or counterclockwise to raise or lower the projector.

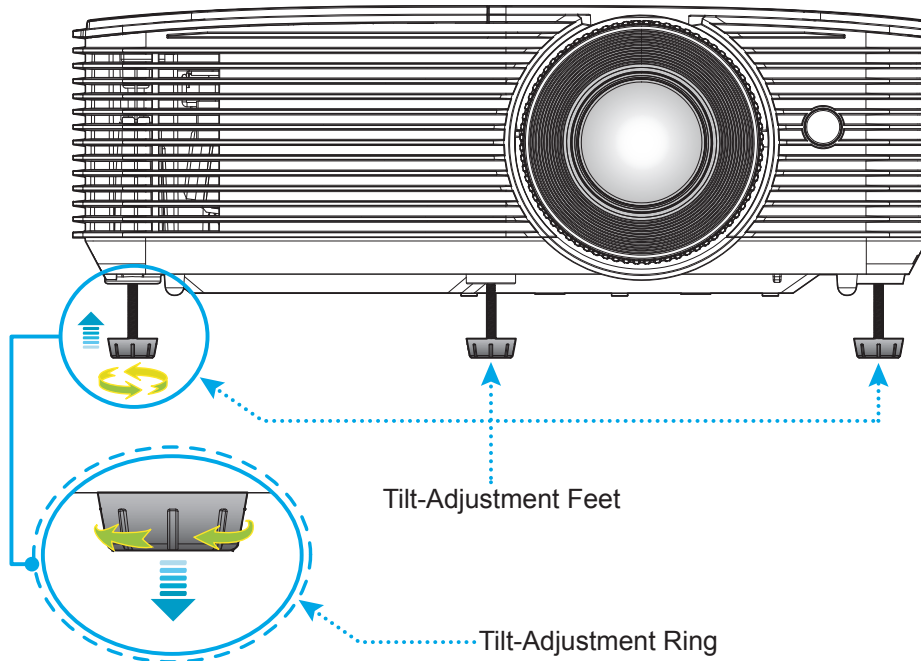

Zoom and focus

- To adjust the image size, turn the zoom lever clockwise or counterclockwise to increase or decrease the projected image size.
- To adjust the focus, turn the focus ring clockwise or counterclockwise until the image is sharp and legible.

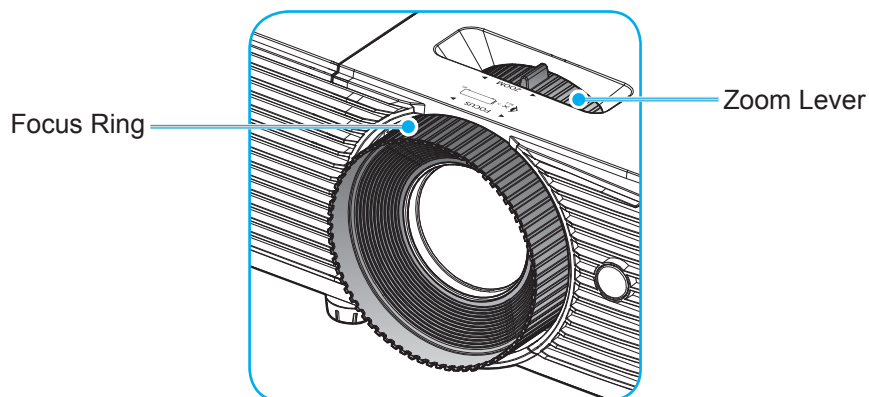

Note: The projector will focus at a distance of 1m to 10m.

SETUP AND INSTALLATION

Installing / replacing the batteries

Two AAA size batteries are supplied for the remote control.

1. Remove the battery cover on the back of the remote control.
2. Insert AAA batteries in the battery compartment as illustrated.
3. Replace back cover on remote control.

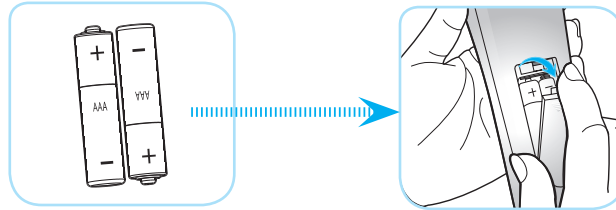

Note: Replace only with the same or equivalent type batteries.

CAUTION

Improper use of batteries can result in chemical leakage or explosion. Be sure to follow the instructions below.

- Do not mix batteries of different types. Different types of batteries have different characteristics.
- Do not mix old and new batteries. Mixing old and new batteries can shorten the life of new batteries or cause chemical leakage in old batteries.
- Remove batteries as soon as they are depleted. Chemicals that leak from batteries that come in contact with skin can cause a rash. If you find any chemical leakage, wipe thoroughly with a cloth.
- The batteries supplied with this product may have a shorter life expectancy due to storage conditions.
- If you will not be using the remote control for an extended period of time, remove the batteries.
- When you dispose of the batteries, you must obey the law in the relative area or country.

SETUP AND INSTALLATION

Effective range

Infra-Red (IR) remote control sensor is located on top of the projector. Ensure to hold the remote control at an angle within 30 degrees perpendicular to the projector's top IR remote control sensor to function correctly. The distance between the remote control and the sensor should not be longer than 6 meters (~ 20 feet).

Note: When pointing the remote control directly (0 degrees angle) on the IR sensor, the distance between the remote control and the sensor should not be longer than 8 meters (~ 26 feet).

- Make sure that there are no obstacles between the remote control and the IR sensor on the projector that might obstruct the infra-red beam.
- Make sure the IR transmitter of the remote control is not being shined by sunlight or fluorescent lamps directly.
- Please keep the remote controller away from fluorescent lamps for over 2 meters or the remote controller might become malfunction.
- If the remote control is close to Inverter-Type fluorescent lamps, it might become ineffective from time to time.
- If the remote control and the projector are within a very short distance, the remote control might become ineffective.
- When you aim at the screen, the effective distance is less than 6 meters from the remote control to the screen and reflecting the IR beams back to the projector. However, the effective range might change according to screens.

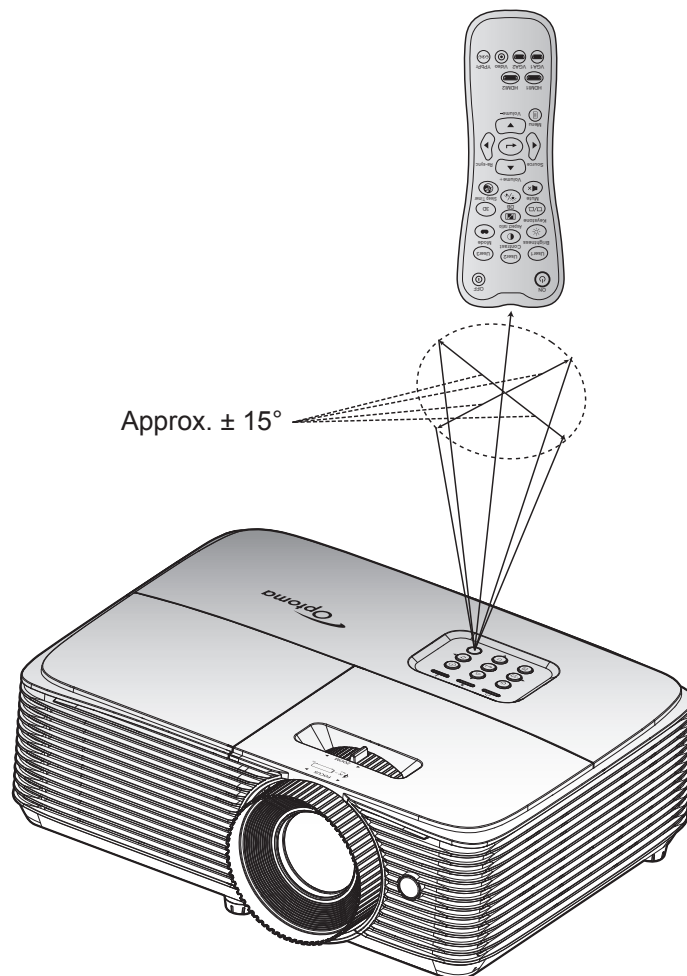

USING THE PROJECTOR

Powering on / off the projector

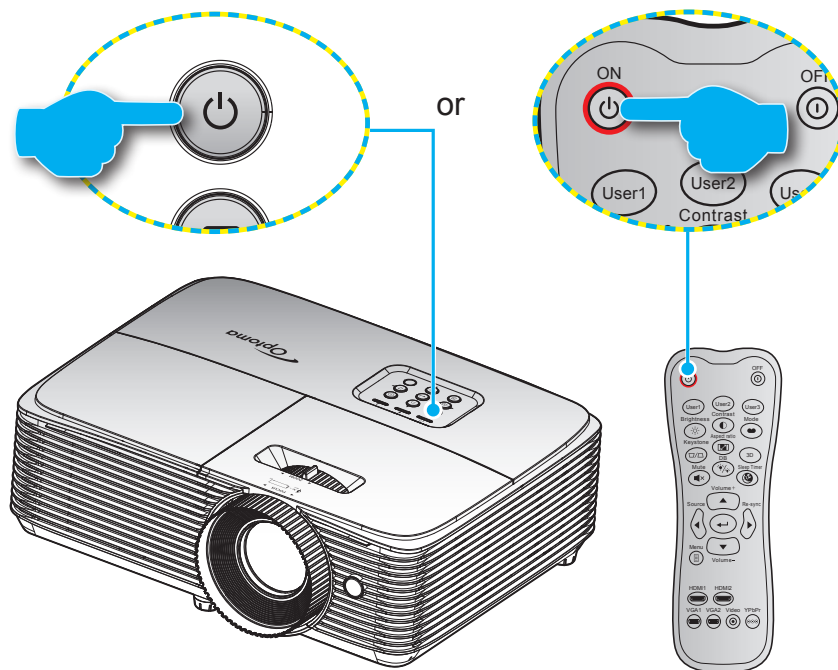

Powering on

1. Securely connect the power lead and signal/source cable. When connected, the On/Standby LED will turn red.
2. Turn on the projector by pressing the "⏻" either on the projector keypad or the remote control.
3. A start up screen will display in approximately 10 seconds and the On/Standby LED will be flashing green or flashing blue.

Note: The first time the projector is turned on, you will be prompted to select the preferred language, projection orientation, and other settings.

Powering off

1. Turn off the projector by pressing the "⏻" either on the projector keypad or the remote control.
2. The following message will be displayed:

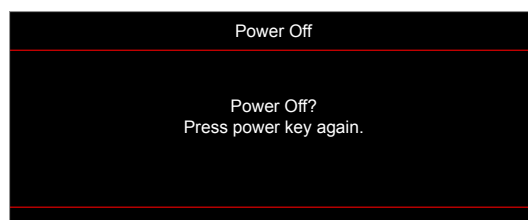

3. Press the "⏻" again to confirm, otherwise the message will disappear after 15 seconds. When you press the "⏻" button for the second time, the projector will shut down.
4. The cooling fans will continue to operate for about 10 seconds for the cooling cycle and the On/Standby LED will flash green or flash blue. When the On/Standby LED turns solid red, this indicates the projector has entered standby mode. If you wish to turn the projector back on, you must wait until the cooling cycle has finished and the projector has entered standby mode. When the projector is in standby mode, simply press the "⏻" button again to turn on the projector.
5. Disconnect the power lead from the electrical outlet and the projector.

Note: It is not recommended that the projector is turned on immediately, right after a power off procedure.

USING THE PROJECTOR

Selecting an input source



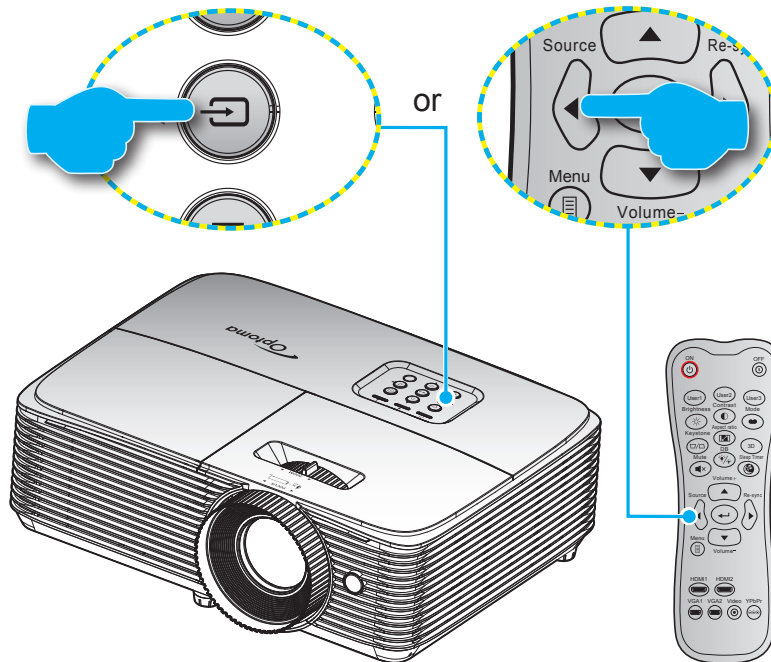











Turn on the connected source that you want to display on the screen, such as computer, notebook, video player, etc. The projector will automatically detect the source. If multiple sources are connected, push the source button on the projector keypad or the remote control to select the desired input.



USING THE PROJECTOR

Menu navigation and features

The projector has multilingual on-screen display menus that allow you to make image adjustments and change a variety of settings. The projector will automatically detect the source.

1. To open the OSD menu, press  on the remote control or the projector keyboard.
2. When OSD is displayed, use   keys to select any item in the main menu. While making a selection on a particular page, press  or  key to enter sub menu.
3. Use   keys to select the desired item in the sub menu and then press  or  key to view further settings. Adjust the settings by using   keys.
4. Select the next item to be adjusted in the sub menu and adjust as described above.
5. Press the  or  to confirm, and the screen will return to the main menu.
6. To exit, press the  or  again. The OSD menu will close and the projector will automatically save the new settings.

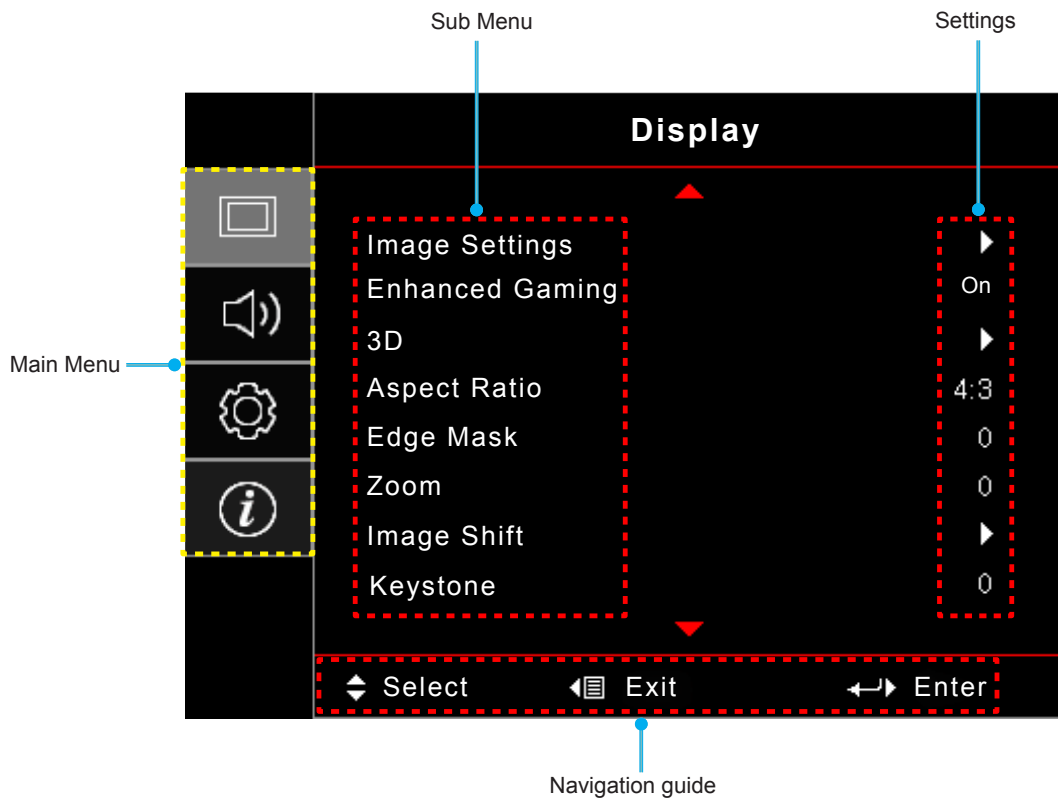

USING THE PROJECTOR







OSD Menu tree

Main Menu	Sub Menu	Sub Menu 2	Sub Menu 3	Sub Menu 4	Values		
Display	Image Settings	Display Mode	[Video]		Cinema		
					Vivid		
					Game		
					Reference		
					Bright		
					USER		
					3D		
					ISF Day		
					ISF Night		
					ISF 3D		
		Wall Color				Off [Default]	
						Blackboard	
						Light Yellow	
						Light Green	
						Light Blue	
						Pink	
		Brightness				Gray	
		Brightness				-50~50	
		Contrast				-50~50	
		Sharpness				1~15	
		Color				-50~50	
		Tint				-50~50	
		Gamma		Film			
				Video			
				Graphics			
				Standard(2.2)			
				1.8			
				2.0			
		Color Settings					2.4
				BrilliantColor™			1~10
			Color Temperature	[Video mode]			Warm
							Standard
					Cool		
					Cold		
Color Matching	Color				R [Default]		
					G		
					B		
					C		
				Y			
				M			
				W			

USING THE PROJECTOR

Main Menu	Sub Menu	Sub Menu 2	Sub Menu 3	Sub Menu 4	Values	
Display	Image Settings	Color Matching	Hue or R		-50~50 [Default: 0]	
			Saturation or G		-50~50 [Default: 0]	
			Gain or B		-50~50 [Default: 0]	
			Reset		Cancel [Default]	
					Yes	
			Exit			
			RGB Gain/Bias	Red Gain		-50~50
				Green Gain		-50~50
				Blue Gain		-50~50
				Red Bias		-50~50
				Green Bias		-50~50
				Blue Bias		-50~50
		Reset			Cancel [Default]	
					Yes	
		Color Space [HDMI Input]			Auto [Default]	
					RGB(0~255)	
					RGB(16~235)	
					YUV	
		Dynamic Black			Off	
					On	
		Brightness Mode [Lamp Base -Video]			Bright	
					Eco.	
		Reset				
		Enhanced Gaming			Off	
				On		
	3D	3D Mode		Off		
				DLP-Link [Default]		
				VESA		
		3D->2D		3D [Default]		
				L		
				R		
		3D Format		Auto [Default]		
				SBS		
				Top and Bottom		
				Frame Sequential		
		3D sync invert		On		
			Off [Default]			

USING THE PROJECTOR

Main Menu	Sub Menu	Sub Menu 2	Sub Menu 3	Sub Menu 4	Values	
Display	Aspect Ratio				4:3	
					16:9	
					LBX [except SVGA XGA models]	
					Native	
					Auto	
	Edge Mask				0~10 [Default: 0]	
	Zoom				-5~25 [Default: 0]	
	Image shift	 H				-50~50 [Default: 0]
 V					-50~50 [Default: 0]	
Keystone					-40~40 [Default: 0]	
Audio	Mute				Off [Default]	
					On	
	Volume					0-10 [Default: 5]
Setup	Projection				Front  [Default]	
					Rear 	
					Ceiling-top 	
					Rear-top 	
	Lamp Settings	Lamp Reminder				Off
						On [Default]
		Lamp Reset				Cancel [Default]
	Filter Settings	Filter Usage Hours				Yes
						No
		Filter Reminder				Off
						300hr
						500hr [Default]
						800hr
		Filter Reset				1000hr
					Cancel [Default]	
	Power Settings	Direct Power On				Off [Default]
						On
		Signal Power On				Off [Default]
						On
		Auto Power Off (min)				0~180 (5 min increments) [Default: 20]
		Sleep Timer (min)				
Always On					No [Default]	
					Yes	





USING THE PROJECTOR

Main Menu	Sub Menu	Sub Menu 2	Sub Menu 3	Sub Menu 4	Values	
Setup	Power Settings	Quick Resume			Off [Default]	
					On	
		USB Power			Off	
					On	
					Auto [Default]	
	Security	Security			Off	
					On	
		Security Timer		Month		
				Day		
				Hour		
	Change Password					
	HDMI Link Settings	HDMI Link			Off	
					On	
		Inclusive of TV			No	
					Yes	
		Power On Link			Mutual	
					PJ --> Device	
					Device --> PJ	
		Power Off Link			Off	
				On		
	Test Pattern				Green Grid	
					Magenta Grid	
					White Grid	
					White	
					Off	
	Remote Settings [depends on remote]	IR Function			On	
					Off	
		User1				HDMI 2 [Default]
						Test Pattern
						Brightness
						Contrast
						Sleep Timer
					Color Matching	
					Color Temperature	
					Gamma	
					Projection	
					Lamp Settings	
					Zoom	
					Freeze	
			MHL			

USING THE PROJECTOR

Main Menu	Sub Menu	Sub Menu 2	Sub Menu 3	Sub Menu 4	Values	
Setup	Remote Settings [depends on remote]	User2			HDMI 2	
					Test Pattern	
					Brightness	
					Contrast	
					Sleep Timer	
					Color Matching	
					Color Temperature	
					Gamma	
					Projection	
					Lamp Settings	
					Zoom	
					Freeze	
				MHL [Default]		
			User3			HDMI 2
						Test Pattern
						Brightness
						Contrast
						Sleep Timer [Default]
						Color Matching
						Color Temperature
						Gamma
						Projection
						Lamp Settings
						Zoom
					Freeze	
				MHL		
		12V Trigger			Off	
					On	
		Options	Language			English [Default]
						Deutsch
						Français
						Italiano
						Español
						Português
						Polski
						Nederlands
					Svenska	
					Norsk/Dansk	
					Suomi	
					ελληνικά	
			繁體中文			
			簡體中文			
			日本語			

USING THE PROJECTOR

Main Menu	Sub Menu	Sub Menu 2	Sub Menu 3	Sub Menu 4	Values	
Setup	Options	Language			한국어	
					Русский	
					Magyar	
					Čeština	
					عربي	
					ไทย	
					Türkçe	
					فارسی	
					Tiếng Việt	
					Bahasa Indonesia	
					Română	
				Slovenčina		
			Menu Settings	Menu Location		Top left 
					Top right 	
					Center  [Default]	
					Bottom left 	
					Bottom right 	
			Menu Timer		Off	
					5sec	
					10sec [Default]	
			Auto Source		Off [Default]	
					On	
			Input Source		HDMI1	
					HDMI2/MHL	
			Input Name	HDMI1		Default [Default]
						Custom
				HDMI2/MHL		Default [Default]
						Custom
			High Altitude		Off [Default]	
					On	
			Display Mode Lock		Off [Default]	
					On	
			Keypad Lock		Off [Default]	
					On	
			Information Hide		Off [Default]	
					On	
	Logo		Default [Default]			
			Neutral			

USING THE PROJECTOR

Main Menu	Sub Menu	Sub Menu 2	Sub Menu 3	Sub Menu 4	Values	
Setup	Options	Background Color			None [Default]	
					Blue	
					Red	
					Green	
					Grey	
					Logo	
	Reset	Reset OSD			Cancel [Default]	
					Yes	
Reset to Default				Cancel [Default]		
				Yes		
Info	Regulatory					
	Serial Number					
	Source					
	Resolution				00x00	
	Refresh Rate				0.00Hz	
	Display Mode					
	Lamp Hours	Bright				0 hr
		Eco.				0 hr
		Dynamic				0 hr
		Total				
	Filter Hours					
	Brightness Mode					
	FW Version	System				
		MCU				

USING THE PROJECTOR

Display menu

Display image settings menu

Display Mode (Video mode)

There are many factory presets optimized for various types of images.

- **Cinema:** Provides the best colors for watching movies.
- **Vivid:** In this mode, the color saturation and brightness are well-balanced. Choose this mode for playing games.
- **Game:** Select this mode to increase the brightness and response time level for enjoying video games.
- **Reference:** Provides the most accurate natural looking colors close to Rec. 709, the standard for High Definition TV(HDTV).
- **Bright:** Maximum brightness from PC input.
- **USER:** Memorize user's settings.
- **3D:** To experience the 3D effect, you need to have 3D glasses. Make sure your PC/portable device has a 120 Hz signal output quad buffered graphics card and a 3D Player installed.
- **ISF Day:** Optimize the image with the ISF Day mode to be perfectly calibrated and high picture quality.
- **ISF Night:** Optimize the image with the ISF Night mode to be perfectly calibrated and high picture quality.
- **ISF 3D:** Optimize the image with the ISF 3D mode to be perfectly calibrated and high picture quality.

Note: For access and calibration of ISF daytime and night viewing modes, please contact your local dealer.

Wall Color

Use this function to obtain an optimized screen image according to the wall color. Select between off, blackboard, light yellow, light green, light blue, pink, and gray.

Brightness

Adjust the brightness of the image.

Contrast

The contrast controls the degree of difference between the lightest and darkest parts of the picture.

Sharpness

Adjust the sharpness of the image.

Color

Adjust a video image from black and white to fully saturated color.

Tint

Adjust the color balance of red and green.

Gamma

Set up gamma curve type. After the initial setup and fine tuning is completed, utilize the Gamma Adjustment steps to optimize your image output.

- **Film:** For home theater.
- **Video:** For video or TV source.
- **Graphics:** For PC / Photo source.
- **Standard(2.2):** For standardized setting.
- **1.8/ 2.0/ 2.4:** For specific PC / Photo source.

USING THE PROJECTOR

Color Settings

Configure the color settings.

- **BrilliantColor™:** This adjustable item utilizes a new color-processing algorithm and enhancements to enable higher brightness while providing true, more vibrant colors in picture.
- **Color Temperature (Video mode):** Select a color temperature from Warm, Standard, Cool, or Cold.
- **Color Matching:** Select the following options:
 - Color: Adjust the red (R), green (G), black (B), cyan (C), yellow (Y), magenta (M), and white (W) level of the image.
 - Hue or R: Adjust the color balance of red and green.
 - Saturation or G: Adjust a video image from black and white to fully saturated color.
 - Gain or B: Adjust the image brightness.
 - Reset: Return the factory default settings for color matching.
 - Exit: Exit the “Color Matching” menu.
- **RGB Gain/Bias:** This settings allows to configure the brightness (gain) and contrast (bias) of an image.
 - Reset: Return the factory default settings for RGB gain/bias.
 - Exit: Exit the “RGB Gain/Bias” menu.
- **Color Space (HDMI input):** select an appropriate color matrix type from the following: Auto, RGB(0-255), RGB(16-235), and YUV.

Dynamic Black

Use to automatically adjust the picture brightness to give optimum contrast performance.

Brightness Mode (Lamp base video)

Adjust the brightness mode settings for lamp-based projectors.

- **Bright:** Choose “Bright” to increase the brightness.
- **Eco.:** Choose “Eco.” to dim the projector lamp which will lower power consumption and extend the lamp life.

Reset

Return the factory default settings for color settings.

Display enhanced gaming menu

Enhanced Gaming

Enable this feature to reduce response times (input latency) during gaming to 16ms*.

Note: *Only for 1080p 60Hz signals.

USING THE PROJECTOR

Display 3D menu

3D Mode

Use this option to disable the 3D function or select the appropriate the 3D function.

- **Off:** Select “Off” to turn off 3D mode.
- **DLP-Link:** Select to use optimized settings for DLP 3D Glasses.
- **VESA:** Select “VESA” to use optimized setting for VESA 3D Glasses.

3D → 2D

Use this option to specify how the 3D content should appear on the screen.

- **3D:** Display 3D signal.
- **L (Left):** Display the left frame of 3D content.
- **R (Right):** Display the right frame of 3D content.

3D Format

Use this option to select the appropriate 3D format content.

- **Auto:** When a 3D identification signal is detected, the 3D format is selected automatically.
- **SBS:** Display 3D signal in “Side-by-Side” format.
- **Top and Bottom:** Display 3D signal in “Top and Bottom” format.
- **Frame Sequential:** Display 3D signal in “Frame Sequential” format.

3D Sync Invert

Use this option to enable/disable the 3D sync invert function.

USING THE PROJECTOR

Display aspect ratio menu



Aspect Ratio

Select the aspect ratio of the displayed image between the following options:

- **4:3:** This format is for 4:3 input sources.
- **16:9:** This format is for 16:9 input sources, like HDTV and DVD enhanced for Wide screen TV.
- **LBX:** This format is for non-16x9, letterbox source and if you use external 16x9 lens to display 2.35:1 aspect ratio in full resolution.
- **Native:** This format displays the original image without any scaling.
- **Auto:** Automatically selects the appropriate display format.

Note:

- *It is considered normal that black bars appear around the image with a resolution of 1080p in each aspect mode.*
- *The black bars and border will change in size depending on the aspect ratio.*

-  Black bars
-  1080p active area

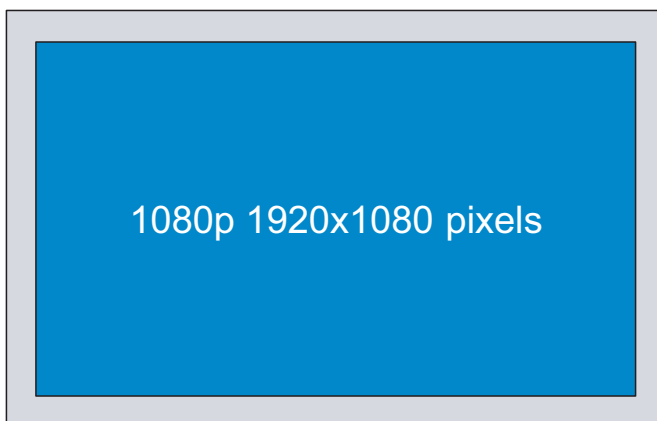

Note:

- *Detailed informations about LBX mode:*
 - *Some Letter-Box Format DVDs are not enhanced for 16x9 TVs. In this situation, the image will not look right when displaying image in 16:9 mode. In this situation, please try to use the 4:3 mode to view the DVD. If the content is not 4:3, there will be black bars around the image in 16:9 display. For this type of content, you can use LBX mode to fill the image on the 16:9 display.*
 - *If you use an external anamorphic lens, this LBX mode also allows you to watch a 2.35:1 content (include Anamorphic DVD and HDTV film source) that supports anamorphic wide is enhanced for 16x9 Display in a wide 2.35:1 image. In this case, there are no black bars. Lamp power and vertical resolution are fully utilized.*
- *To use the superwide format, do the following:*
 - Set the screen aspect ratio to 2.0:1.*
 - Align the projector image correctly on the screen.*

USING THE PROJECTOR

1080P scaling table:

16:9 screen	480i/p	576i/p	1080i/p	720p	PC
4x3	Scale to 1440x1080.				
16x9	Scale to 1920x1080.				
LBX	Scale to 1920x1440, then get the central 1920x1080 image to display.				
Native mode	-1:1 mapping centered. -No scaling will be made; the image is displayed with the resolution based on input source.				
Superwide	Scale to 2534 x 1426 (132% Enlarge), then get the central 1920x1080 image to display Ps: End-user can use this format to see non-subtitle of 2.35:1 source to fulfill 100% of 1080p DMD.				

Display edge mask menu

Edge Mask

Use this function to remove the video encoding noise on the edge of video source.

Display zoom menu

Zoom

Use to reduce or magnify an image on the projection screen.

Display image shift menu

Image Shift

Adjust the projected image position horizontally (H) or vertically (V).

Display keystone menu

Keystone

Adjust the image distortion caused by tilting the projector.

USING THE PROJECTOR

Audio menu

Audio mute menu

Mute

Use this option to temporarily turn off the sound.

- **On:** Choose the “On” to turn mute on.
- **Off:** Choose the “Off” to turn mute off.

Note:

- *“Mute” function affects both internal and external speaker volume.*
- *When an external speaker is connected, the internal speaker is automatically muted.*

Audio volume menu

Volume

Adjust the audio volume level.

Setup menu

Setup projection menu

Projection

Select the preferred projection between front, rear, ceiling-top, and rear-top.

Setup lamp settings menu

Lamp Reminder

Choose this function to show or to hide the warning message when the changing lamp message is displayed. The message will appear 30 hours before suggested replacement of lamp.

Lamp Reset

Resets the lamp hour counter after replacing the lamp.

Setup filter settings menu

Filter Usage Hours

Display the filter time.

Optional Filter Installed

Set the warning message setting.

- **Yes:** Display warning message after 500 hours of use.

Note: *“Filter Usage Hours / Filter Reminder / Filter Reset” will only appear when “Optional Filter Installed” is “Yes”.*

- **No:** Turn off warning message.

USING THE PROJECTOR

Filter Reminder

Choose this function to show or hide the warning message when the changing filter message is displayed. The available options include Off, 300hr, 500hr, 800hr, and 1000hr.

Filter Reset

Reset the dust filter counter after replacing or cleaning the dust filter.

Setup power settings menu

Direct Power On

Choose “On” to activate Direct Power mode. The projector will automatically power on when AC power is supplied, without pressing the “Power” key on the projector keypad or on the remote control.

Signal Power On

Choose “On” to activate Signal Power mode. The projector will automatically power on when a signal is detected, without pressing the “Power” key on the projector Keypad or on the remote control.

Note:

- *If the “Signal Power On” option is turned “On”, the power consumption of the projector in standby mode will be over 3W.*
- Signal Power On can support VGA (RGB signal) and HDMI.

Auto Power Off (min)

Sets the countdown timer interval. The countdown timer will start, when there is no signal being sent to the projector. The projector will automatically power off when the countdown has finished (in minutes).

Sleep Timer (min)

Configure the sleep timer.

- **Sleep Timer (min):** Sets the countdown timer interval. The countdown timer will start, with or without a signal being sent to the projector. The projector will automatically power off when the countdown has finished (in minutes).
Note: *The Sleep Timer is reset every time when the projector is powered off.*
- **Always On:** Check to set the sleep timer always on.

Quick Resume

Set the quick resume setting.

- **On:** If the projector is accidentally turned off, this feature allows the projector to be instantly powered on again, if selected within a period of 100 seconds.
- **Off:** The fan will start cooling the system after 10 seconds when user turns off the projector.

USB Power

Set the USB power settings.

- **On:** The projector is always powered on by a USB power source.
- **Off:** The USB Power function is off.
- **Auto:** The projector is automatically powered on by a USB power source.

USING THE PROJECTOR

Setup security menu

Security

Enable this function to prompt for a password before using the projector.

- **On:** Choose “On” to use security verification when the turning on the projector.
- **Off:** Choose “Off” to be able to switch on the projector without password verification.

Security Timer

Can be select the time (Month/Day/Hour) function to set the number of hours the projector can be used. Once this time has elapsed you will be requested to enter your password again.

Change Password

Use to set or modify the password that is prompted when turning the projector on.

Setup HDMI link settings menu

Note:

- *When you connect HDMI CEC-compatible devices to the projector with HDMI cables, you can control them on the same power on or power off status using the HDMI Link control feature in the projector’s OSD. This lets one device or multiple devices in a group power on or power off via HDMI Link Feature in a typical configuration, your DVD player may be connected to the projector through an amplifier or home theater system.*

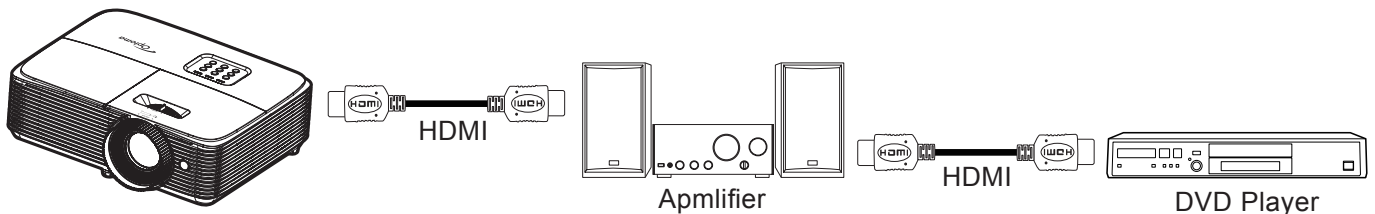

HDMI Link

Enable/disable the HDMI Link function. The inclusive TV, power on link, and power off link options will only available if the setting is set to “On”.

Inclusive of TV

Set to “Yes” if you prefer both TV and projector to be automatically turned off at the same time. To prevent both devices to be turned off at the same time, set the setting to “No”.

Power On Link

CEC power on command.

- **Mutual:** Both projector and CEC device will be turned on simultaneously.
- **PJ -> Device:** The CEC device will be turned on only after the projector is switched on.
- **Device -> PJ:** The projector will be switched on only after the CEC device is turned on.

Power Off Link

Enable this function to let both HDMI Link and projector to be automatically turned off at the same time.

USING THE PROJECTOR

Setup test pattern menu

Test Pattern

Select the test pattern from green grid, magenta grid, white grid, white or disable this function (off).

Setup remote settings menu

IR Function

Set the IR function setting.

- **On:** Choose “On”, the projector can be operated by the remote control from top IR receiver.
- **Off:** Choose “Off”, the projector can't be operated by the remote control. By selecting “Off”, you will be able to use the Keypad keys.

User1/ User2/ User3

Assign the default function for User1, User2, or User3 between HDMI 2, Test Pattern, Brightness, Contrast, Sleep Timer, Color Matching, Color Temperature, Gamma, Projection, Lamp Settings, Zoom, Freeze, and MHL.

Setup 12V trigger menu

12V Trigger

Use this function to enable or disable the trigger.

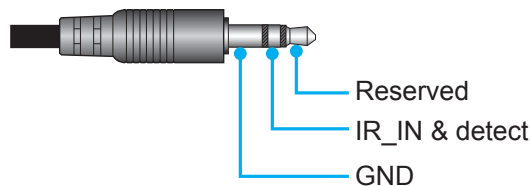

- **Off:** Choose “Off” to disable the trigger.
- **On:** Choose “On” to enable the trigger.

Setup options menu

Language



Select the multilingual OSD menu between English, German, French, Italian, Spanish, Portuguese, Polish, Dutch, Swedish, Norwegian/Danish, Finnish, Greek, traditional Chinese, simplified Chinese, Japanese, Korean, Russian, Hungarian, Czechoslovak, Arabic, Thai, Turkish, Farsi, Vietnamese, Indonesian, Romanian, and Slovakian.

Menu Settings

Set the menu location on the screen and configure menu timer settings.

- **Menu Location:** Select the menu location on the display screen.
- **Menu Timer:** Set the duration where the OSD menu stays visible on the screen.

Auto Source

If you set this option “On” and press the  button on the projector keypad or  button on the remote control then the next available input source is selected automatically. Set “Off” to disable auto source function.

Input Source

Select the input source between HDMI1 and HDMI2/MHL.

USING THE PROJECTOR

Input Name

Use to rename the input function for easier identification. The available options include HDMI1 and HDMI2/MHL.

High Altitude

When “On” is selected, the fans will spin faster. This feature is useful in high altitude areas where the air is thin.

Display Mode Lock

Choose “On” or “Off” to lock or unlock adjusting display mode settings.

Keypad Lock

When the keypad lock function is “On”, the Keypad will be locked. However, the projector can be operated by the remote control. By selecting “Off”, you will be able to reuse the Keypad.

Information Hide

Enable this function to hide the information message.

- **Off:** Choose “On” to hide the info message.
- **On:** Choose “Off” to show the “searching” message.

Logo

Use this function to set the desired startup screen. If changes are made, they will take effect the next time the projector is powered on.

- **Default:** The default startup screen.
- **Neutral:** Logo is not displayed on startup screen.

Background Color

Use this function to display a blue, red, green, grey color, none, or logo screen when no signal is available.

Note: *If the background color is set to “None”, then the background color is black.*

Setup reset menu

Reset OSD

Return the factory default settings for OSD menu settings.

Reset to Default

Return the factory default settings for Setup menu settings.

USING THE PROJECTOR

Info menu

Info menu

View the projector information as listed below:

- Regulatory
- Serial Number
- Source
- Resolution
- Refresh Rate
- Display Mode
- Lamp Hours
- Filter Hours
- Brightness Mode
- FW Version

MAINTENANCE

Replacing the lamp

The projector automatically detects the lamp life. When the lamp life is nearing the end of use, a warning message will appear on the screen.



When you see this message, please contact your local reseller or service center to change the lamp as soon as possible. Make sure the projector has been cooled down for at least 30 minutes before changing the lamp.



Warning: If ceiling mounted, please use caution when opening the lamp access panel. It is recommended to wear safety glasses if changing the bulb when ceiling mounted. Caution must be used to prevent any loose parts from falling out of projector.



Warning: Lamp compartment is hot! Allow it to cool down before changing lamp!



Warning: To reduce the risk of personal injury, do not drop the lamp module or touch the lamp bulb. The bulb may shatter and cause injury if it is dropped.

MAINTENANCE

Replacing the lamp (continued)

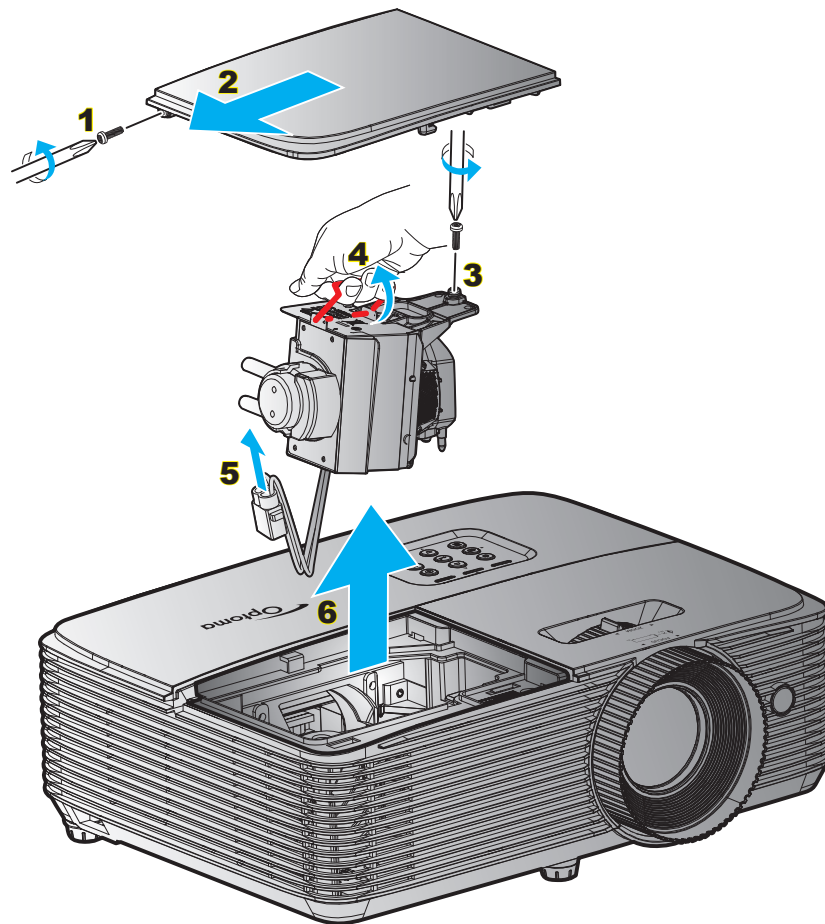

Procedure:

1. Switch off the power to the projector by pressing the "⏻" button on the remote control or the projector keypad.
2. Allow the projector to cool down for at least 30 minutes.
3. Disconnect the power cord.
4. Unscrew the screw on the cover. **1**
5. Remove the cover. **2**
6. Unscrew the screw on the lamp module. **3**
7. Lift up the lamp handle. **4**
8. Remove the lamp cord. **5**
9. Remove the lamp module carefully. **6**
10. To replace the lamp module, reverse the previous steps.
11. Turn on the projector and reset the lamp timer.
12. Lamp Reset: (i) Press "Menu" → (ii) Select "Setup" → (iii) Select "Lamp Settings" → (iv) Select "Lamp Reset" → (v) Select "Yes".

Note:

- The screw on the lamp cover and the lamp cannot be removed.
- The projector cannot be turned on if the lamp cover has not been placed back on the projector.
- Do not touch the glass area of the lamp. Hand oil can cause the lamp shatter. Use a dry cloth to clean the lamp module if it was accidentally touched.

MAINTENANCE

Installing and cleaning the dust filter

Installing the dust filter

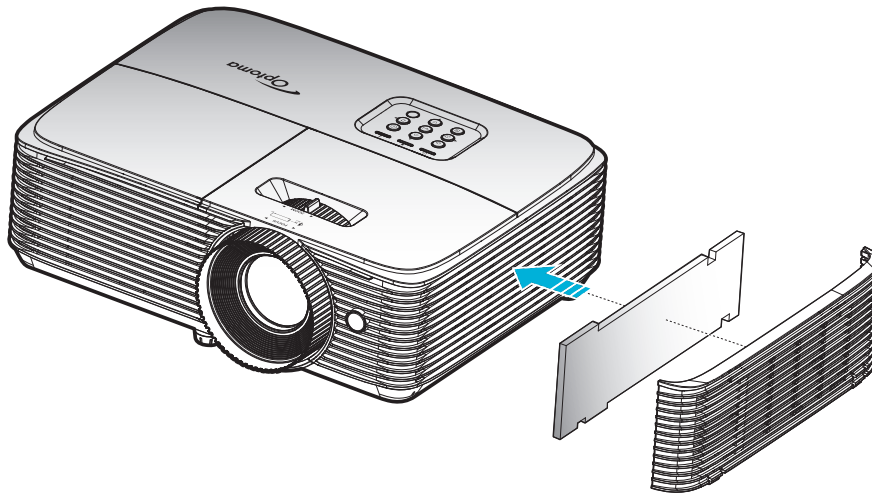

Note: Dust filters are only required/supplied in the selected regions with excessive dust.

Cleaning the dust filter

We recommend you to clean the dust filter every three months. Clean it more often if the projector is used in a dusty environment.

Procedure:

1. Switch off the power to the projector by pressing the "⏻" button on the remote control or the projector keypad.
2. Disconnect the power cord.
3. Remove the dust filter carefully. **1**
4. Clean or replace the dust filter. **2**
5. To install the dust filter, reverse the previous steps.

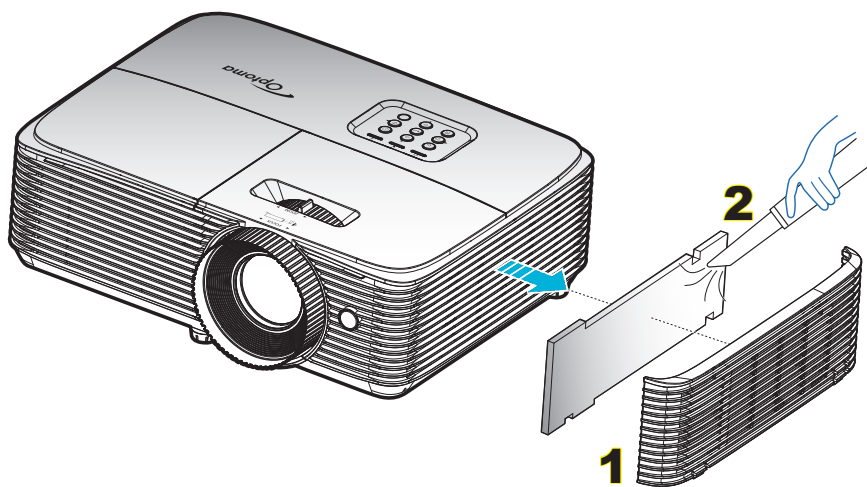

ADDITIONAL INFORMATION

Compatible resolutions

Digital compatibility

B0/Established Timing	B0/Standard Timing	B0/Detail Timing	B1/Video Mode	B1/Detail Timing
720 x 400 @ 70Hz	1280 x 720 @ 60Hz	Native timing:	640 x 480p @ 60Hz	720 x 480p @ 60Hz
640 x 480 @ 60Hz	1280 x 800 @ 60Hz	XGA: 1024 x 768 @ 60Hz	720 x 480p @ 60Hz	1280 x 720p @ 60Hz
640 x 480 @ 67Hz	1280 x 1024 @ 60Hz	WXGA: 1280 x 800 @ 60Hz	1280 x 720p @ 60Hz	1366 x 768 @ 60Hz
640 x 480 @ 72Hz	1400 x 1050 @ 60Hz	1080P: 1920 x 1080 @ 60Hz	1920 x 1080i @ 60Hz	1920 x 1080i @ 50Hz
640 x 480 @ 75Hz	1600 x 1200 @ 60Hz		720(1440) x 480i @ 60Hz	1920 x 1080p @ 60Hz
800 x 600 @ 56Hz	1440 x 900 @ 60Hz		1920 x 1080p @ 60Hz	
800 x 600 @ 60Hz	1280 x 720 @ 120Hz		720 x 576p @ 50Hz	
800 x 600 @ 72Hz	1024 x 768 @ 120Hz		1280 x 720p @ 50Hz	
800 x 600 @ 75Hz			1920 x 1080i @ 50Hz	
832 x 624 @ 75Hz			720(1440) x 576i @ 50Hz	
1024 x 768 @ 60Hz			1920 x 1080p @ 50Hz	
1024 x 768 @ 70Hz			1920 x 1080p @ 24Hz	
1024 x 768 @ 75Hz			1920 x 1080p @ 30Hz	
1280 x 1024 @ 75Hz				
1152 x 870 @ 75Hz				

True 3D video compatibility

Input resolution	HDMI 1.4a 3D Input	Input timing			
			1280 x 720P @ 50Hz	Top - and - Bottom	
			1280 x 720P @ 60Hz	Top - and - Bottom	
			1280 x 720P @ 50Hz	Frame packing	
			1280 x 720P @ 60Hz	Frame packing	
			1920 x 1080i @ 50Hz	Side- by-Side (Half)	
			1920 x 1080i @ 60Hz	Side- by-Side (Half)	
			1920 x 1080P @ 24Hz	Top - and- Bottom	
			1920 x 1080P @ 24Hz	Frame packing	
		HDMI 1.3	1920 x 1080i @ 50Hz	Side-by-Side(Half)	SBS mode is on
			1920 x 1080i @ 60Hz		
			1280 x 720P @ 50Hz		
			1280 x 720P @ 60Hz		
			1920 x 1080i @ 50Hz	Top-and-Bottom	TAB mode is on
			1920 x 1080i @ 60Hz		
			1280 x 720P @ 50Hz		
			1280 x 720P @ 60Hz		
			480i 1024 x 768 @ 120Hz	HQFS	3D format is Frame sequential
		1280 x 720 @ 120Hz			

Note:

- If 3D input is 1080p@24Hz, the DMD should replay with integral multiple with 3D mode.
- Support NVIDIA 3DTV Play if there is no patent fee from Optoma.
- 1080i@25Hz and 720p@50Hz will run in 100Hz; 1080p@24Hz will run in 144Hz; other 3D timing will run in 120Hz.

ADDITIONAL INFORMATION

Image size and projection distance

Desired Distance (m)	Screen size		Top	Screen size		Top
	(Min zoom)			(Max zoom)		
	Diagonal (inch)	W (cm) x H (cm)	From base to top of image (cm)	Diagonal (inch)	W (cm) x H (cm)	From base to top of image (cm)
1.2	33.46	74 x 42	48	37	82 x 46	53
2	56	123 x 69	81	61	136 x 77	89
2.5	70	154 x 87	101	77	170 x 96	111
3	84	185 x 104	121	92	204 x 115	133
3.5	98	216 x 122	141	108	238 x 134	155
4	112	247 x 139	161	123	272 x 153	178
5	139	309 x 174	201	154	340 x 191	222
6	167	370 x 208	242	184	408 x 230	266
7	195	432 x 243	282	215	476 x 268	311
8	223	494 x 278	322	246	544 x 306	355
9	251	556 x 313	363	277	612 x 344	399
10	279	617 x 347	403	307.29	680 x 383	444

Note: Zoom ratio is 1.1x.

Desired image size		Distance (m)		Top (cm)
Diagonal (inch)	W (cm) x H (cm)	Max zoom	Min zoom	From base to top of image
37	82 x 46	1.2	1.3	53
40	89 x 50	1.3	1.4	58
50	111 x 62	1.6	1.8	72
60	133 x 75	2.0	2.2	87
70	155 x 87	2.3	2.5	101
80	177 x 100	2.6	2.9	116
90	199 x 112	2.9	3.2	130
100	221 x 125	3.3	3.6	144
120	266 x 149	3.9	4.3	173
150	332 x 187	4.9	5.4	217
200	443 x 249	6.5	7.2	289
250	553 x 311	8.1	9.0	361
300	664 x 374	9.8	10.8	433
307.3	680 x 383	10.0	11.0	444

Note: Zoom ratio is 1.1x.

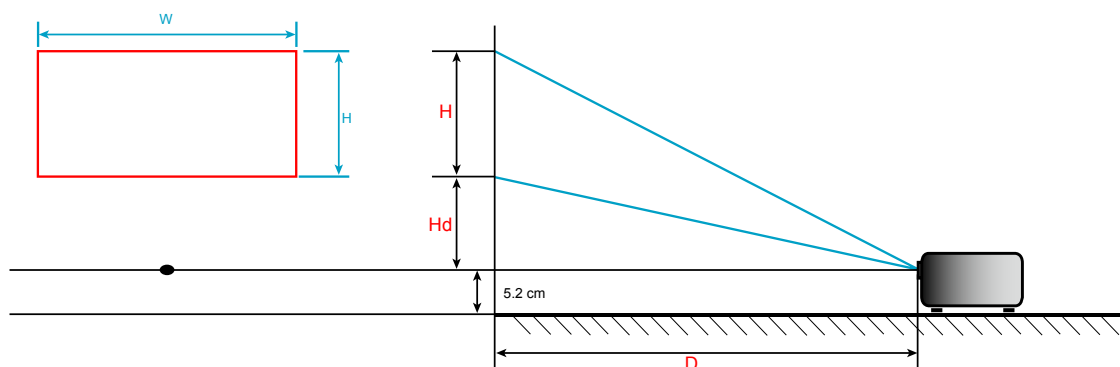

ADDITIONAL INFORMATION

Projector dimensions and ceiling mount installation

1. To prevent damage to your projector, please use the Optoma ceiling mount.
2. If you wish to use a third party ceiling mount kit, please ensure the screws used to attach a mount to the projector meet the following specifications:
 - Screw type: M4*3
 - Minimum screw length: 10mm

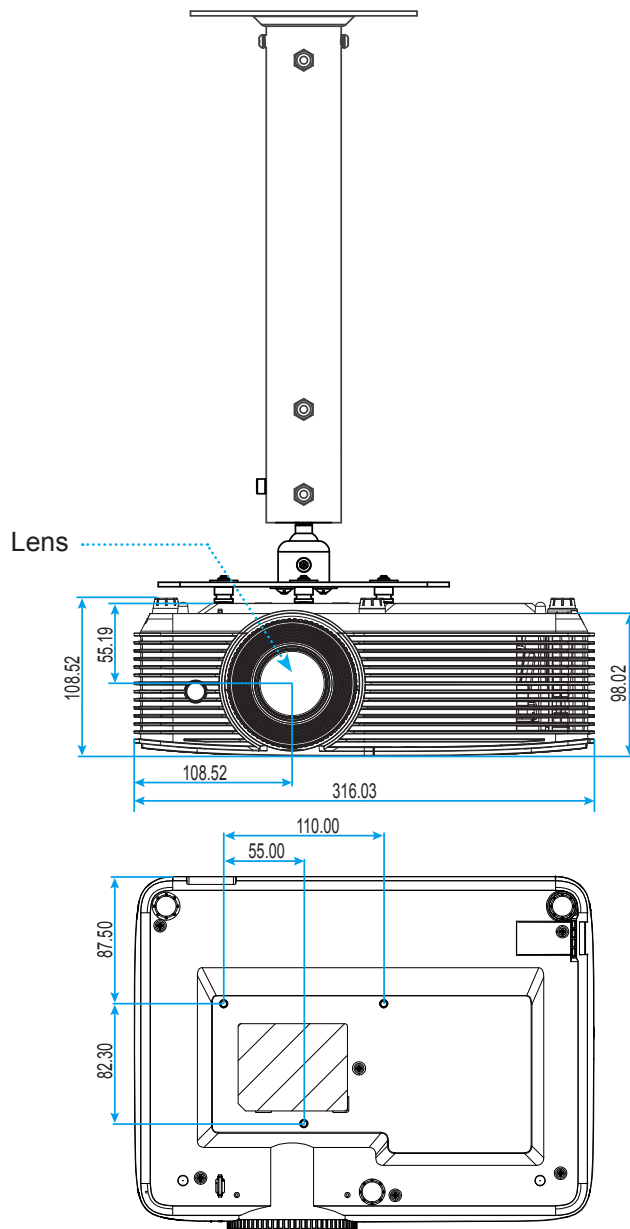

Note: Please note that damage resulting from incorrect installation will void the warranty.



Warning:

- If you buy a ceiling mount from another company, please be sure to use the correct screw size. Screw size will vary depending on the thickness of the mounting plate.
- Be sure to keep at least 10 cm gap between the ceiling and the bottom of the projector.
- Avoid installing the projector near a heat source.





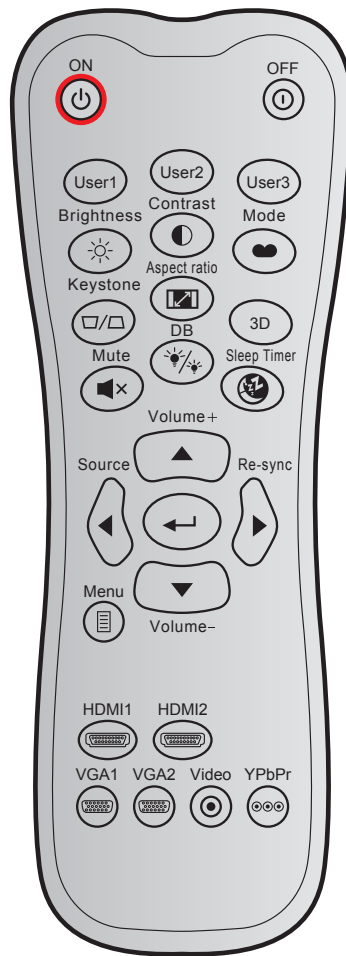









ADDITIONAL INFORMATION

IR remote control codes



Key		Custom code		Data code	Printing-key definition	Description
		Byte 1	Byte 2	Byte 3		
Power on		32	CD	02	ON	Press to turn on the projector.
Power off		32	CD	2E	OFF	Press to turn off the projector.
User 1		32	CD	36	User1	User defined keys. Please see page 37 to setup.
User 2		32	CD	65	User2	
User 3		32	CD	66	User3	
Brightness		32	CD	41	Brightness	Adjust the brightness of the image.
Contrast		32	CD	42	Contrast	Control the degree of difference between the lightest and darkest parts of the picture.
Display mode		32	CD	05	Mode	Select a display mode for optimized settings for different applications. Please see page 29.
Keystone		32	CD	07	Keystone	Adjust image distortion caused by tilting the projector.
Aspect ratio		32	CD	64	Aspect ratio	Press to change aspect ratio of a displayed image.

ADDITIONAL INFORMATION







Key		Custom code		Data code	Printing-key definition	Description
		Byte 1	Byte 2	Byte 3		
3D		32	CD	89	3D	Manually select a 3D mode that matches your 3D content.
Volume +		32	CD	09	Volume +	Adjust to increase volume.
Four direction keys		32	CD	11	▲	Use ▲, ◀, ▶, or ▼ to select items or make adjustments to your selection.
		32	CD	10	◀	
		32	CD	12	▶	
		32	CD	14	▼	
Source		32	CD	18	Source	Press “Source” to select an input signal.
Enter key		32	CD	0F		Confirm your item selection.
Re-sync		32	CD	04	Re-sync	Automatically synchronizes the projector to the input source.
Volume -		32	CD	0C	Volume -	Adjust to decrease volume.
Menu		32	CD	0E	Menu	Display or exit the on-screen display menus for projector.
HDMI 1		32	CD	16	HDMI1	Press “HDMI1” to choose source from HDMI 1 connector.
HDMI 2		32	CD	30	HDMI2	Press “HDMI2” to choose source from HDMI 2 / MHL connector.
VGA 1		32	CD	1B	VGA1	No function
VGA 2		32	CD	1E	VGA2	No function
Video		32	CD	1C	Video	No function
YPbPr		32	CD	17	YPbPr	No function

ADDITIONAL INFORMATION

Troubleshooting

If you experience a problem with your projector, please refer to the following information. If a problem persists, please contact your local reseller or service center.

Image problems

-  *No image appears on-screen*
- Ensure all the cables and power connections are correctly and securely connected as described in the "Installation" section.
 - Ensure the pins of connectors are not crooked or broken.
 - Check if the projection lamp has been securely installed. Please refer to the "Replacing the Lamp" section.
 - Ensure that the "Mute" feature is not turned on.
-  *Image is out of focus*
- Adjust the Focus Ring on the projector lens.
 - Make sure the projection screen is between the required distance from the projector. (Please refer to page 44).
-  *The image is stretched when displaying 16:9 DVD title*
- When you play anamorphic DVD or 16:9 DVD, the projector will show the best image in 16: 9 format on projector side.
 - If you play the LBX format DVD title, please change the format as LBX in projector OSD.
 - If you play 4:3 format DVD title, please change the format as 4:3 in projector OSD.
 - Please setup the display format as 16:9 (wide) aspect ratio type on your DVD player.
-  *Image is too small or too large*
- Adjust the Zoom Lever on the top of the projector.
 - Move the projector closer to or further from the screen.
 - Press "Menu" on the projector panel, go to "Display-->Aspect Ratio". Try the different settings.
-  *Image has slanted sides:*
- If possible, reposition the projector so that it is centered on the screen and below the bottom of the screen.
 - Use "Display-->Keystone" from the OSD to make an adjustment.
-  *Image is reversed*
- Select "Setup-->Projection" from the OSD and adjust the projection direction.
-  *Blurry double image*
- Press "3D" button and switch to "Off" to avoid normal 2D image is blurry double image.

ADDITIONAL INFORMATION



Two images, side-by-side format

- Press "3D" button and switch to "SBS" for input signal is HDMI 1.3 2D 1080i side-by-side.



Image does not display in 3D

- Check if the battery of 3D glasses is drained.
- Check if the 3D glasses is turned on.
- When the input signal is HDMI 1.3 2D (1080i side-by-side half), press "3D" button and switch to "SBS".

Other problems



The projector stops responding to all controls

- If possible, turn off the projector, then unplug the power cord and wait at least 20 seconds before reconnecting power.



Lamp burns out or makes a popping sound

- When the lamp reaches its end of life, it will burn out and may make a loud popping sound. If this happens, the projector will not turn on until the lamp module has been replaced. To replace the lamp, follow the procedures in the "Replacing the Lamp" section on pages 40-41.

Remote control problems



If the remote control does not work

- Check the operating angle of the remote control is pointed within $\pm 15^\circ$ to the IR receiver on the projector.
- Make sure there are not any obstructions between the remote control and the projector. Move to within 6 m (20 ft) of the projector.
- Make sure batteries are inserted correctly.
- Replace batteries if they are exhausted.

ADDITIONAL INFORMATION





Warning indicators

When the warning indicators (see below) light up or flash, the projector will automatically shutdown:

- "LAMP" LED indicator is lit red and if "On/Standby" indicator flashes red.
- "TEMP" LED indicator is lit red and if "On/Standby" indicator flashes red. This indicates the projector has overheated. Under normal conditions, the project can be switched back on.
- "TEMP" LED indicator flashes red and if "On/Standby" indicator flashes red.

Unplug the power cord from the projector, wait for 30 seconds and try again. If the warning indicator light up or flash, please contact your nearest service center for assistance.

LED lightning messages

Message	 Power LED	 Power LED	 Temp-LED	 Lamp-LED
	(Red)	(Green or Blue)	(Red)	(Red)
Standby state (Input power cord)	Steady light			
Power on (Warming)		Flashing (0.5 sec off / 0.5 sec on)		
Power on & Lamp lighting		Steady light		
Power off (Cooling)		Flashing (0.5 sec off / 0.5 sec light). Back to red steady light when cooling fan turns off.		
Quick Resume (100 secs)		Flashing (0.25 sec off / 0.25 sec on)		
Error (Lamp fail)	Flashing			Steady light
Error (Fan failure)	Flashing		Flashing	
Error (Over Temp)	Flashing		Steady light	
Standby State (Burn in mode)	Flashing (0.5 sec off / 0.5 sec on)	Flashing (0.5 sec off / 0.5 sec on)	Flashing (0.5 sec off / 0.5 sec on)	Flashing (0.5 sec off / 0.5 sec on)
Burnin (Warming)		Flashing		
Burnin (Cooling)		Flashing		
Power On (Burn in Mode)		Flashing (0.5 sec off / 0.5 sec on)		

- Power off:

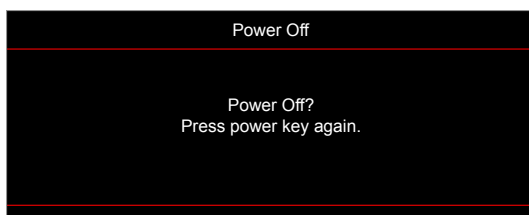

ADDITIONAL INFORMATION

- Lamp warning:



- Temperature warning:

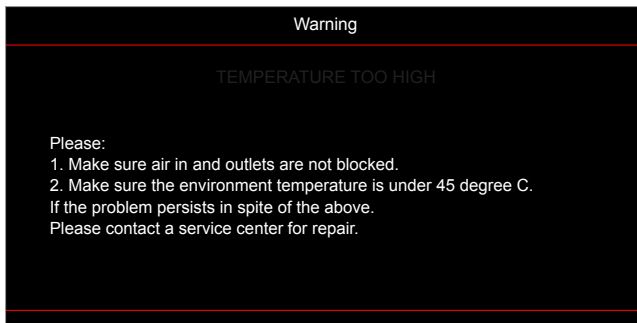

- Fan failed:

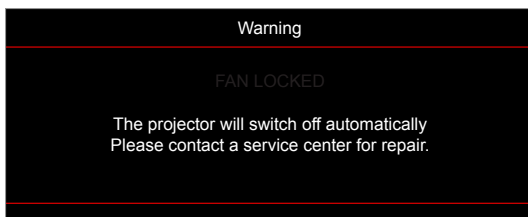

- Out of display range:

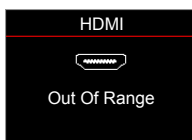

- Power down warning:

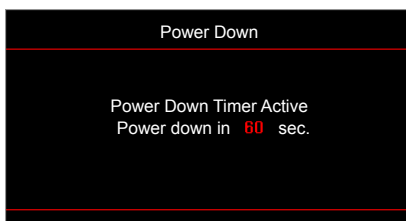

- Security timer alarm:



ADDITIONAL INFORMATION

Specifications

Optical	Description
Native resolution	1080p
Lens	Manual zoom and manual focus
Image size (diagonal)	28"~301"
Projection distance	1m ~ 10m (focus range)

Electrical	Description
Inputs	- HDMI 1.4b - HDCP 1.4
Color reproduction	1073.4 Million color
Scan rate	- Horizontal scan rate: 15.375~91.146 KHz - Vertical scan rate: 50~ 85 Hz (120Hz for 3D feature projector)
Built-in speaker	Yes, 10W
Power requirement	100 - 240V AC 50/60Hz
Input current	3.3A

Mechanical	Description
Installation orientation	Front, Rear, Ceiling - Top, Rear - Top
Dimensions	- 316 mm (W) x 243 mm (D) x 106 mm (H) (without feet) - 316 mm (W) x 243 mm (D) x 108.5 mm (H) (with feet)
Weight	2.8 ±0.5kg
Environmental conditions	Operating in 5 ~ 40°C , 10% to 85% humidity (non-condensing)

Note: All specifications are subject to change without notice.



ADDITIONAL INFORMATION

Optoma global offices

For service or support, please contact your local office.



USA

3178 Laurelview Ct.
Fremont, CA 94538, USA
www.optomausa.com

 888-289-6786
 510-897-8601
 services@optoma.com



Canada

3178 Laurelview Ct.
Fremont, CA 94538, USA
www.optomausa.com

 888-289-6786
 510-897-8601
 services@optoma.com



Latin America

3178 Laurelview Ct.
Fremont, CA 94538, USA
www.optomausa.com

 888-289-6786
 510-897-8601
 services@optoma.com



Europe

Unit 1, Network 41, Bourne End Mills
Hemel Hempstead, Herts,
HP1 2UJ, United Kingdom
www.optoma.eu
Service Tel : +44 (0)1923 691865

 +44 (0) 1923 691 800
 +44 (0) 1923 691 888
 service@tsc-europe.com



Benelux BV

Randstad 22-123
1316 BW Almere
The Netherlands
www.optoma.nl

 +31 (0) 36 820 0252
 +31 (0) 36 548 9052



France

Bâtiment E
81-83 avenue Edouard Vaillant
92100 Boulogne Billancourt, France

 +33 1 41 46 12 20
 +33 1 41 46 94 35
 savoptoma@optoma.fr



Spain

C/ José Hierro,36 Of. 1C
28522 Rivas VaciaMadrid,
Spain

 +34 91 499 06 06
 +34 91 670 08 32



Deutschland

Wiesenstrasse 21 W
D40549 Düsseldorf,
Germany

 +49 (0) 211 506 6670
 +49 (0) 211 506 66799
 info@optoma.de

Scandinavia



Lerpeveien 25
3040 Drammen
Norway

 +47 32 98 89 90
 +47 32 98 89 99
 info@optoma.no

PO.BOX 9515
3038 Drammen
Norway

Korea

WOOMI TECH.CO.,LTD.
4F, Minu Bldg.33-14, Kangnam-Ku,
Seoul,135-815, KOREA
korea.optoma.com

 +82+2+34430004
 +82+2+34430005



Japan

東京都足立区綾瀬3-25-18
株式会社オーエス
コンタクトセンター:0120-380-495

 info@os-worldwide.com
www.os-worldwide.com



Taiwan

12F., No.213, Sec. 3, Beixin Rd.,
Xindian Dist., New Taipei City 231,
Taiwan, R.O.C.
www.optoma.com.tw

 +886-2-8911-8600
 +886-2-8911-6550
 services@optoma.com.tw
asia.optoma.com



Hong Kong

Unit A, 27/F Dragon Centre,
79 Wing Hong Street,
Cheung Sha Wan,
Kowloon, Hong Kong

 +852-2396-8968
 +852-2370-1222
www.optoma.com.hk

China

5F, No. 1205, Kaixuan Rd.,
Changning District
Shanghai, 200052, China

 +86-21-62947376
 +86-21-62947375
www.optoma.com.cn



P/N:36.7AY01G001-A