

DLP Projector

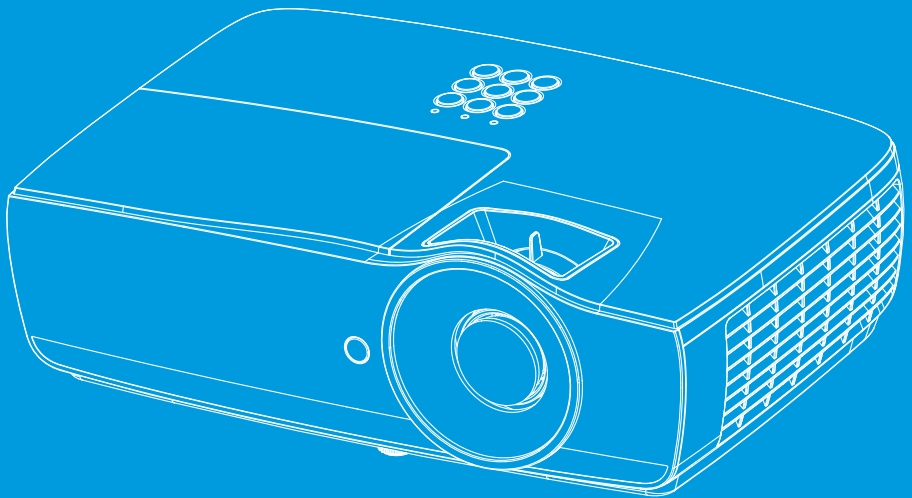

User manual



Table of contents

+	+	+	Table of contents.....	2
+	+	+	Usage Notice.....	4
			Safety Information	4
			Precautions.....	5
			Eye Safety Warnings.....	7
+	+	+	Introduction.....	8
			Package Overview.....	8
			Product Overview	9
			Main Unit.....	9
			Connection Ports	10
			Remote Control.....	11
+	+	+	Installation	12
			Connecting the Projector.....	12
			Connect to Notebook	12
			Connect to Video Sources	13
			Powering On/Off the Projector.....	14
			Powering On the Projector.....	14
			Powering Off the Projector.....	15
			Warning Indicator.....	15
			Adjusting the Projected Image.....	16
			Adjusting the Projector's Height.....	16
			Adjusting Projection Image Size (EH460).....	17
			Adjusting Projection Image Size (EH465).....	18
			Adjusting Projection Image Size (EH460ST)	19
			Adjusting Projection Image Size (WU465).....	20
			Adjusting Projection Image Size (X460)	21
			Adjusting Projection Image Size (W460)	22
			Adjusting Projection Image Size (W460ST).....	23
+	+	+	User Controls	24
			Remote Control	24
			On-screen Display Menus	26
			How to operate.....	26
			Menu Tree	27
			Display	30
			Display Image Settings	32
			Display 3D.....	34
			Display Geometric Correction	35
			Display Image Settings / Color Setting	36
			Display Image Settings / Signal	37
			Display Image Settings / Color Setting / Color Matching	38
			Audio.....	39
			Setup.....	40
			Setup / Lamp Settings.....	42

Table of contents

Setup / Power Settings	43
Setup / Security.....	45
Setup / HDMI Link Settings.....	47
Setup / Remote Settings.....	48
Setup / Options	49
Setup / Options / Language.....	51
Setup / Options / Menu Settings	52
Setup / Options / Input Source.....	53
Network.....	54
Network / LAN.....	55
Network / Control	56
Information.....	57
Media.....	58
How to set up File Type for Multimedia with USB.....	58
LAN_RJ45	62
Appendices.....	70
 Troubleshooting.....	70
Image.....	70
Other.....	71
Projector LED Status Indicator.....	72
Remote Control.....	73
Replacing the Lamp.....	74
Compatible resolutions	78
True 3D Video Compatibility table	80
RS232 Commands and Protocol Function List.....	81
RS232 Pin Assignments (projector side).....	81
RS232 Protocol Function List	82
Telnet Commands	96
AMX Device Discovery Commands.....	96
PJLink™ Supported Commands	97
Trademarks	99
Ceiling Mount Installation	100
Optoma Global Offices	101
Regulation & Safety Notices.....	103

Safety Information

	The lightning flash with arrow head within an equilateral triangle is intended to alert the user to the presence of uninsulated "dangerous voltage" within the product's enclosure that may be of sufficient magnitude to constitute a risk of electric shock to persons.
	The exclamation point within an equilateral triangle is intended to alert the user to the presence of important operating and maintenance (servicing) instructions in the literature accompanying the appliance.

WARNING: TO REDUCE THE RISK OF FIRE OR ELECTRIC SHOCK, DO NOT EXPOSE THIS APPLIANCE TO RAIN OR MOISTURE. DANGEROUS HIGH VOLTAGES ARE PRESENT INSIDE THE ENCLOSURE. DO NOT OPEN THE CABINET. REFER SERVICING TO QUALIFIED PERSONNEL ONLY.

Class B emissions limits

This Class B digital apparatus meets all requirements of the Canadian Interference-Causing Equipment Regulations.

Important Safety Instruction

1. Do not block any ventilation openings. To ensure reliable operation of the projector and to protect from over heating, it is recommended to install the projector in a location that does not block ventilation. As an example, do not place the projector on a crowded coffee table, sofa, bed, etc. Do not put the projector in an enclosure such as a book case or a cabinet that restricts air flow.
2. Do not use the projector near water or moisture. To reduce the risk of fire and/or electric shock, do not expose the projector to rain or moisture.
3. Do not install near heat sources such as radiators, heaters, stoves or any other apparatus such as amplifiers that emits heat.
4. Clean only with dry cloth.
5. Only use attachments/accessories specified by the manufacturer.
6. Do not use the unit if it has been physically damaged or abused.
Physical damage/abuse would be (but not limited to):
 - Unit has been dropped.
 - Power supply cord or plug has been damaged.
 - Liquid has been spilled on to the projector.
 - Projector has been exposed to rain or moisture.
 - Something has fallen in the projector or something is loose inside.Do not attempt to service the unit yourself. Opening or removing covers may expose you to dangerous voltages or other hazards. Please call Op-toma before you send the unit for repair.
7. Do not let objects or liquids enter the projector. They may touch dangerous voltage points and short out parts that could result in fire or electric shock.
8. See projector enclosure for safety related markings.
9. The unit should only be repaired by appropriate service personnel.

Precautions



Please follow all warnings, precautions and maintenance as recommended in this user's guide.

- Warning- Do not look into the projector's lens when the lamp is on. The bright light may hurt your eyes. As with any bright source, do not stare into the direct beam, RG2 IEC 62471-5:2015.



- Warning- To reduce the risk of fire or electric shock, do not expose this projector to rain or moisture.
- Warning- Please do not open or disassemble the projector as this may cause electric shock.
- Warning- When replacing the lamp, please allow the unit to cool down. Follow instructions as described on page 74.
- Warning- This projector will detect the life of the lamp itself. Please be sure to change the lamp when it shows warning messages.
- Warning- Reset the "Lamp Reset" function from the on-screen display "System|Lamp Setting" menu after replacing the lamp module (refer to pages 42).
- Warning- When switching the projector off, please ensure the cooling cycle has been completed before disconnecting power. Allow 90 seconds for the projector to cool down.
- Warning- Do not use lens cap when projector is in operation.
- Warning- When the lamp is approaching to the end of its life time, the message "Replacement suggested" will show on the screen. Please contact your local reseller or service center to change the lamp as soon as possible.

Note

When the lamp reaches the end of its life, the projector will not turn back on until the lamp module has been replaced. To replace the lamp, follow the procedures listed under "Replacing the Lamp" section on page 74.

Usage Notice



Do:

- ■ Turn off and unplug the power plug from the AC outlet before cleaning the product.
- ■ Use a soft dry cloth with mild detergent to clean the display housing.
- ■ Disconnect the power plug from AC outlet if the product is not being used for a long period of time.

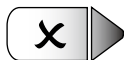

Do not:

- ■ Block the slots and openings on the unit provided for ventilation.
- ■ Use abrasive cleaners, waxes or solvents to clean the unit.
- ■ Use under the following conditions:
 - In extremely hot, cold or humid environments.
 - ▶ Ensure that the ambient room temperature is within 5 - 40°C
 - ▶ Relative Humidity is 10 - 85% (Max.), non-condensing
 - In areas susceptible to excessive dust and dirt.
 - Near any appliance generating a strong magnetic field.
 - In direct sunlight.

Eye Safety Warnings



- Avoid staring/facing directly into the projector beam at all times. Keep your back to the beam as much as possible.
- When projector is used in a classroom, adequately supervise students when they are asked to point out something on the screen.
- In order to minimize the lamp power, use room blinds to reduce ambient light levels.

Note

Keep this manual for future reference..

Package Overview

Unpack and inspect the box contents to ensure all parts listed below are in the box. If something is missing, please contact Optoma customer service.

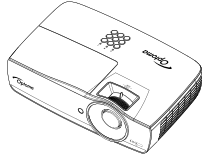

Projector with lens cap

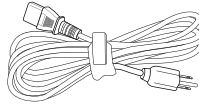

Power Cord 1.8m

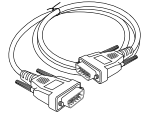

15 pin D-sub VGA Cable

Note

Due to different applications in each Country, some regions may have different accessories.

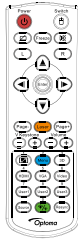

Remote Control

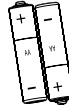

2 x AAA Batteries

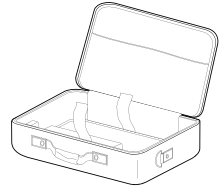

Carrying Case

Documentation :

- User's Manual
- Warranty Card
- Basic User's Manual

Product Overview

Main Unit

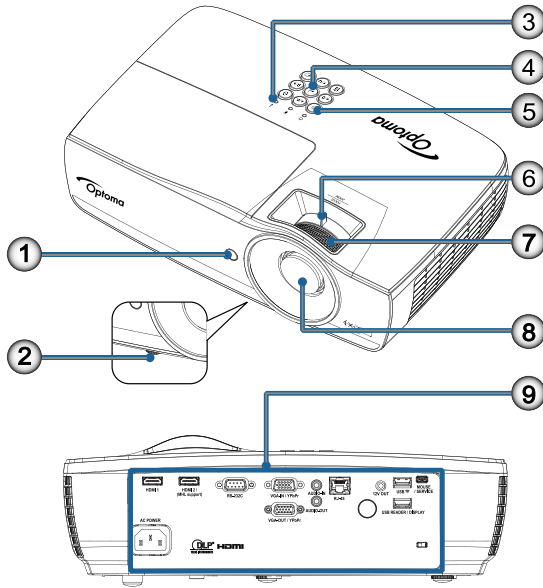

1. IR Receiver
2. Tilt-Adjustment Feet
3. LED Indicators
4. Function Keys
5. Power Button
6. Zoom (Not available in 1080p short throw)
7. Focus
8. Lens
9. Connection Ports

Introduction

Connection Ports

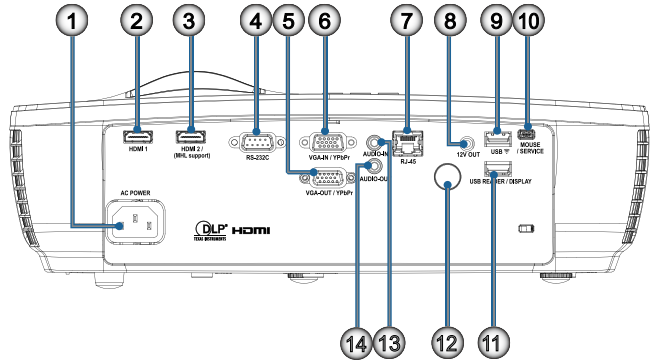

1. Power Socket
2. HDMI1
3. HDMI2 / (MHL support)
4. RS-232C
5. VGA-OUT / YPbPr
6. VGA-IN / YPbPr
7. RJ-45
8. 12V OUT
9. USB 
10. MOUSE / SERVICE
11. USB READER / DISPLAY
12. IR Receiver
13. AUDIO IN
14. AUDIO OUT

Introduction



CAUTION

Use of controls, adjustments or performance of procedures other than those specified herein may result in hazardous laser light exposure.

Complies with FDA performance standards for laser products except for deviations pursuant to Laser Notice No. 50, dated June 24, 2007.







Warning:

- RISK OF EXPLOSION IF BATTERY IS REPLACED BY AN INCORRECT TYPE.
- DISPOSE OF USED BATTERIES ACCORDING TO THE INSTRUCTIONS.



Due to generic remote, function is model dependent.

Remote Control

1. Power On/Off
2. 
3. Freeze
4. USB mouse Left click
5. Four Directional Select Keys
6. Enter
7. Laser (**DO NOT POINT IN EYES**)
8. Page-
9. V Keystone +/-
10. /1 (Number Button for password input)
11. HDMI/4
12. User1/7
13. Source
14. Menu/2
15. VGA/5
16. Switch
17. 
18. USB mouse Right click
19. Page+
20. Volume +/-
21. 3D/3
22. Video/6
23. User3/9
24. Resync
25. User2/8
26. /0

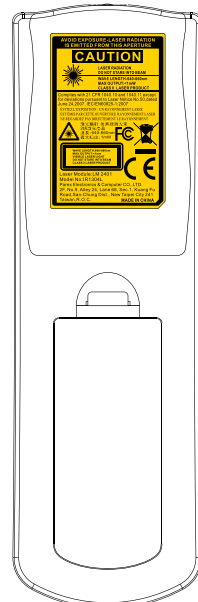
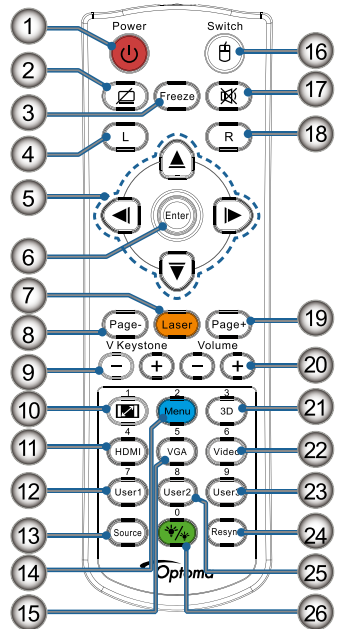

Connecting the Projector

Connect to Notebook

Note

Due to the difference in applications for each country, some regions may have different accessories.

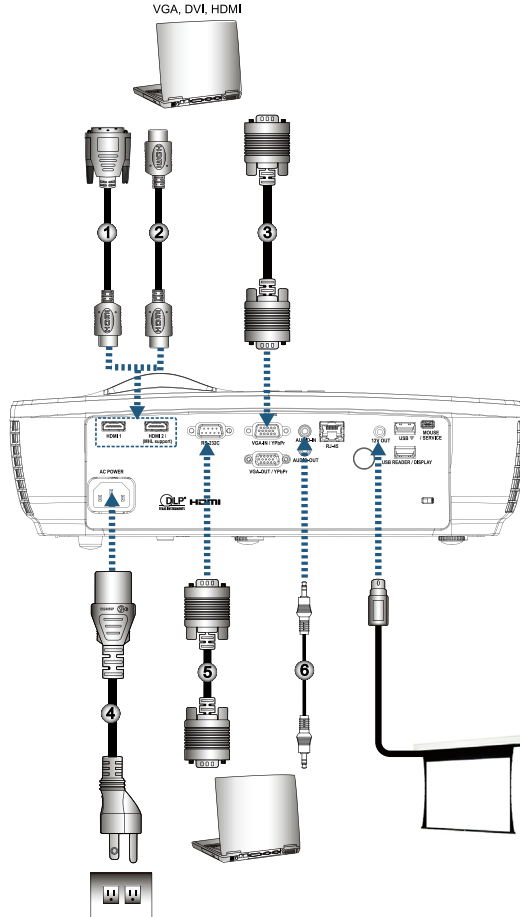

- 1.....DVI/HDMI Cable (Optional Accessory)
- 2.....HDMI Cable (Optional Accessory)
- 3.....VGA Input Cable
- 4.....Power Cord
- 5.....RS232 Cable (Optional Accessory)
- 6.....Audio Cable (Optional Accessory)

Installation

Connect to Video Sources

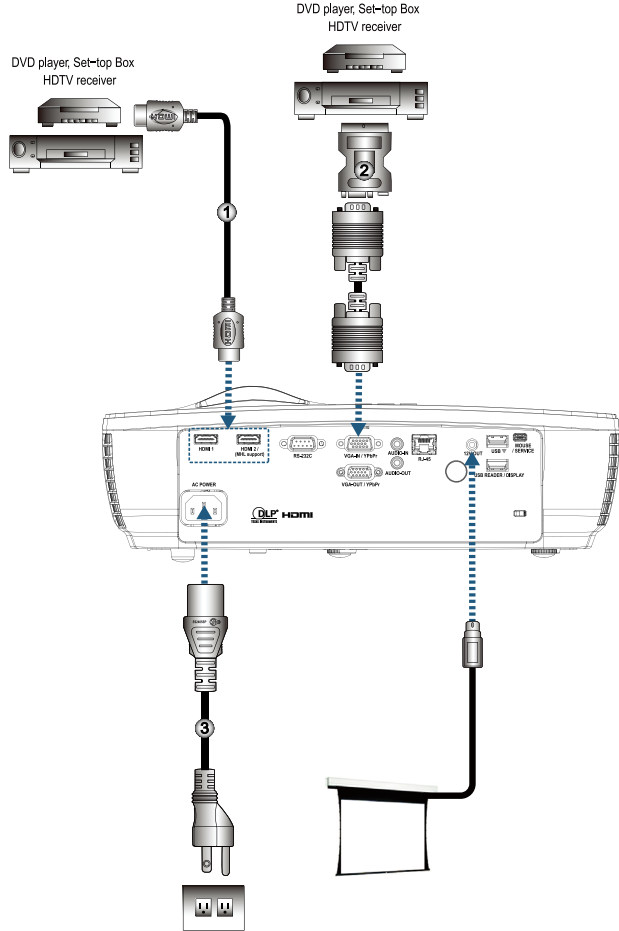

Note

Due to the difference in applications for each country, some regions may have different accessories.

Note

12V OUT is a programmable trigger.

- 1.....HDMI Cable (Optional Accessory)
- 2.....SCART RGB/S-Video Adapter (Optional Accessory)
- 3.....Power Cord

Powering On/Off the Projector

Powering On the Projector

1. Remove the lens cover.
2. Connect the power cord to the projector.
3. Turn On the connected devices.
4. Ensure the Power LED is steady green and then press the power button to turn On the projector.

Note

Turn on the projector first and then select the signal sources.

The projector's startup logo screen displays and connected devices are detected. If the connected device is a laptop, press the appropriate keys on the computer keyboard to switch the display output to the projector. (Check the user manual of the laptop to determine the appropriate Fn key combination to change display output.)

See Security Settings on page 45 if security lock is enabled.



Note

Due to the difference in applications for each country, some regions may have different accessories.

If more than one input device is connected, press  (Source) button sequentially to switch between devices.

For direct source selection, see page 25.

Note

12V OUT is a programmable trigger.



Powering Off the Projector

1. Press the "⏻" button on the remote control or ⏻ (**POWER**) button on the panel of the projector to turn off the projector. First push of button will display the following message on the screen.

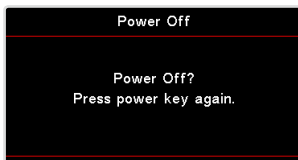

Press the button again to confirm the shut down. If the button is not pressed, the message will disappear in 5 seconds.

2. The Power LED flashes green (1 sec on, 1sec off) and the fans will speed up during shut down cooling cycle. The projector reaches stand-by mode as soon as the Power LED steady red.

If you wish to turn the projector back on, you must wait until the projector has completed the cooling cycle and has entered standby mode. Once in standby mode, simply press ⏻ (**POWER**) button on the panel of the projector or "⏻" on the remote control to restart the projector.

3. Disconnect the power cord from the electrical outlet and the projector only when the projector is in stand-by mode.

Warning Indicator

- When the Lamp LED indicator lights red, the projector will automatically shut itself down. Please contact your local reseller or service center. See page 72.
- When the Temp LED is on a steady (not flashing) red, the projector will automatically shut itself down. Under normal conditions, the projector can be switched on again after it has cooled down. If the problem persists, you should contact your local dealer or our service center. See page 72.

Note

Contact the nearest service center if the projector displays these symptoms. See page 101 for more information.

Adjusting the Projected Image

Adjusting the Projector's Height



The projector is equipped with tilt-adjuster feet for adjusting the image height.

- The projector table or stand should be level and sturdy.
- Position the projector so that it is perpendicular to the screen.
- For personal safety, please secure the cables properly.

To adjust the angle of the picture, turn the tilt-adjuster right or left until the desired angle has been achieved.

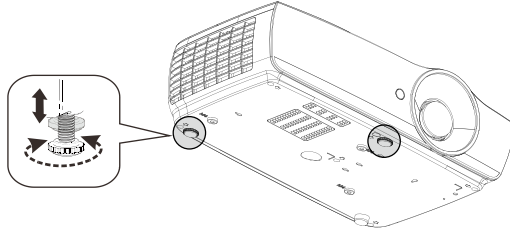

Installation

Adjusting Projection Image Size (EH460)

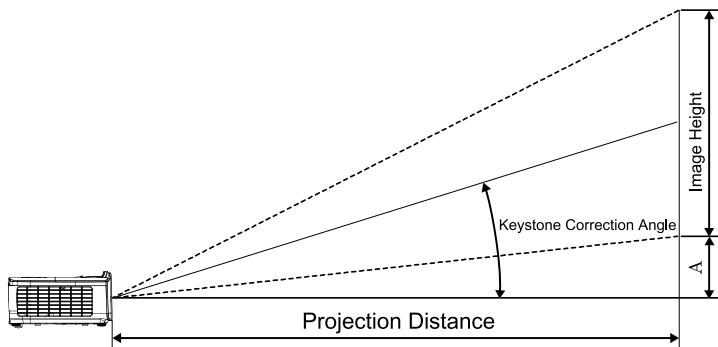

English

Diagonal length (inch) size of 16:9 Screen	Screen Size W X H (16:9)				Projection distance (D)				Offset (A)	
	(m)		(feet)		(m)		(feet)		(m)	(feet)
	Width	Height	Width	Height	Wide	Tele	Wide	Tele		
30	0.66	0.37	2.18	1.23	0.81	0.97	2.66	3.19	0.06	0.18
40	0.89	0.50	2.91	1.63	1.08	1.30	3.54	4.25	0.07	0.24
60	1.33	0.75	4.36	2.45	1.62	1.94	5.32	6.38	0.11	0.37
80	1.77	1.00	5.81	3.27	2.16	2.59	7.09	8.50	0.15	0.49
100	2.21	1.25	7.26	4.09	2.70	3.24	8.86	10.63	0.19	0.61
120	2.66	1.49	8.72	4.90	3.24	3.89	10.63	12.75	0.22	0.73
140	3.10	1.74	10.17	5.72	3.78	4.53	12.41	14.88	0.26	0.85
160	3.54	1.99	11.62	6.54	4.32	5.18	14.18	17.00	0.30	0.97
190	4.21	2.37	13.80	7.76	5.13	6.15	16.84	20.19	0.35	1.16
230	5.09	2.86	16.71	9.40	6.21	7.45	20.38	24.44	0.43	1.40
280	6.20	3.49	20.34	11.44	7.56	9.07	24.81	29.75	0.52	1.71
300	6.64	3.74	21.79	12.26	8.10	9.72	26.58	31.88	0.56	1.83



Note
300" (overdrive) for Asia.

Installation

Adjusting Projection Image Size (EH465)

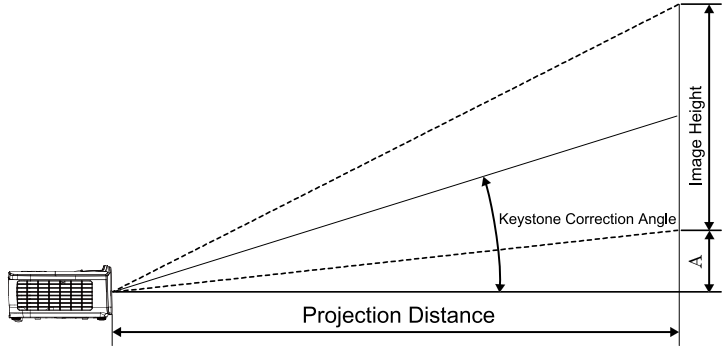

Diagonal length (inch) size of 16:9 Screen	Screen Size W X H (16:9)				Projection distance (D)				Offset (A)	
	(m)		(feet)		(m)		(feet)		(m)	(feet)
	Width	Height	Width	Height	Wide	Tele	Wide	Tele		
30	0.66	0.37	2.18	1.23	0.92	1.39	3.03	4.55	0.06	0.18
40	0.89	0.50	2.91	1.63	1.23	1.85	4.04	6.07	0.07	0.24
60	1.33	0.75	4.36	2.45	1.85	2.78	6.06	9.11	0.11	0.37
80	1.77	1.00	5.81	3.27	2.46	3.70	8.08	12.14	0.15	0.49
100	2.21	1.25	7.26	4.09	3.08	4.63	10.10	15.18	0.19	0.61
120	2.66	1.49	8.72	4.90	3.69	5.55	12.11	18.22	0.22	0.73
140	3.10	1.74	10.17	5.72	4.31	6.48	14.13	21.25	0.26	0.85
160	3.54	1.99	11.62	6.54	4.92	7.40	16.15	24.29	0.30	0.97
190	4.21	2.37	13.80	7.76	5.85	8.79	19.18	28.84	0.35	1.16
230	5.09	2.86	16.71	9.40	7.08	10.64	23.22	34.91	0.43	1.40
280	6.20	3.49	20.34	11.44	8.62	12.96	28.27	42.50	0.52	1.71
300	6.64	3.74	21.79	12.26	9.23	13.88	30.29	45.54	0.56	1.83

Installation

Adjusting Projection Image Size (EH460ST)

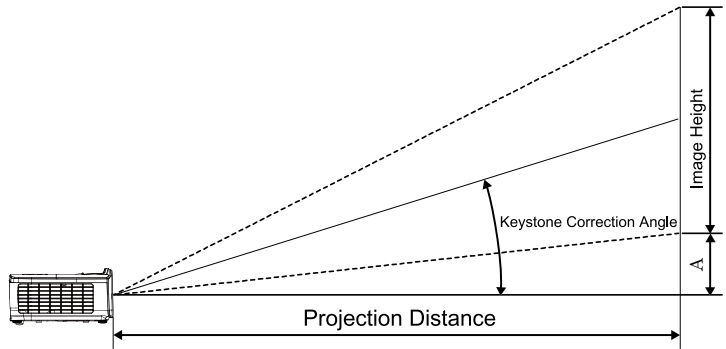

English

Diagonal length (inch) size of 16:9 Screen	Screen Size W X H (16:9)				Projection distance (D)		Offset (A)	
	(m)		(feet)		(m)	(feet)		
	Width	Height	Width	Height	ST	ST	(m)	(feet)
30	0.66	0.37	2.18	1.23	0.33	1.09	0.06	0.18
40	0.89	0.50	2.91	1.63	0.44	1.45	0.07	0.24
60	1.33	0.75	4.36	2.45	0.66	2.18	0.11	0.37
80	1.77	1.00	5.81	3.27	0.89	2.91	0.15	0.49
100	2.21	1.25	7.26	4.09	1.11	3.63	0.19	0.61
120	2.66	1.49	8.72	4.90	1.33	4.36	0.22	0.73
140	3.10	1.74	10.17	5.72	1.55	5.08	0.26	0.85
160	3.54	1.99	11.62	6.54	1.77	5.81	0.30	0.97
190	4.21	2.37	13.80	7.76	2.10	6.90	0.35	1.16
230	5.09	2.86	16.71	9.40	2.55	8.35	0.43	1.40
280	6.20	3.49	20.34	11.44	3.10	10.17	0.52	1.71
300	6.64	3.74	21.79	12.26	3.32	10.89	0.56	1.83

Installation

Adjusting Projection Image Size (WU465)

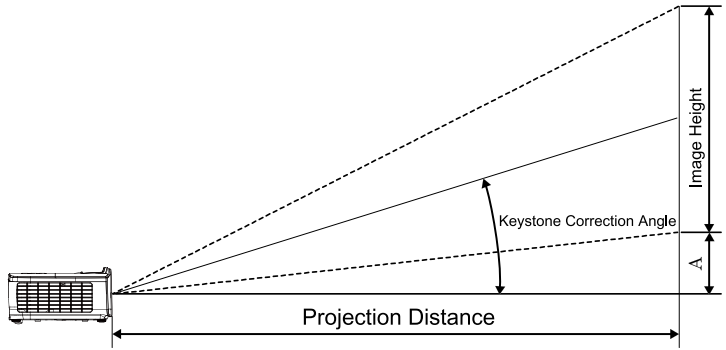

Diagonal length (inch) size of 16:10 Screen	Screen Size W X H (16:10)				Projection distance (D)				Offset (A)	
	(m)		(feet)		(m)		(feet)		(m)	(feet)
	Width	Height	Width	Height	Wide	Tele	Wide	Tele		
30	0.65	0.40	2.12	1.32	0.90	1.35	2.95	4.43	0.03	0.11
40	0.86	0.54	2.83	1.77	1.20	1.80	3.93	5.91	0.05	0.15
60	1.29	0.81	4.24	2.65	1.80	2.70	5.89	8.86	0.07	0.22
80	1.72	1.08	5.65	3.53	2.40	3.60	7.86	11.82	0.09	0.30
100	2.15	1.35	7.07	4.42	2.99	4.50	9.82	14.77	0.11	0.37
120	2.58	1.62	8.48	5.30	3.59	5.40	11.79	17.72	0.14	0.45
140	3.02	1.88	9.89	6.18	4.19	6.30	13.75	20.68	0.16	0.52
160	3.45	2.15	11.31	7.07	4.79	7.20	15.72	23.63	0.18	0.60
190	4.09	2.56	13.43	8.39	5.69	8.55	18.66	28.06	0.22	0.71
230	4.95	3.10	16.25	10.16	6.89	10.35	22.59	33.97	0.26	0.86
280	6.03	3.77	19.79	12.37	8.38	12.60	27.50	41.35	0.32	1.04
300	6.46	4.04	21.20	13.25	8.98	13.51	29.47	44.31	0.34	1.12

Installation

Adjusting Projection Image Size (X460)

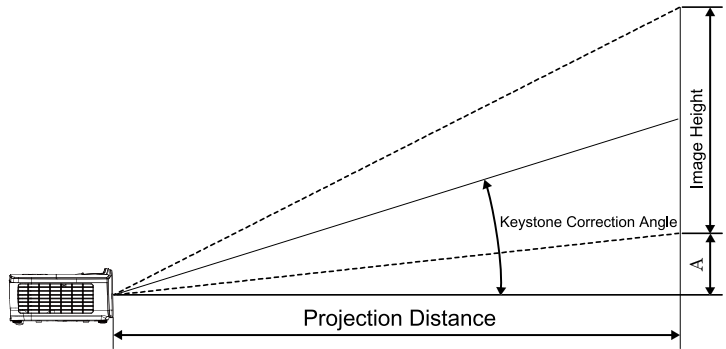

English

Diagonal length (inch) size of 4:3 Screen	Screen Size W X H (4:3)				Projection distance (D)				Offset (A)	
	(m)		(feet)		(m)		(feet)		(m)	(feet)
	Width	Height	Width	Height	Wide	Tele	Wide	Tele		
30	0.61	0.46	2.00	1.50	0.98	1.17	3.20	3.84	0.06	0.21
40	0.81	0.61	2.67	2.00	1.30	1.56	4.27	5.12	0.08	0.28
60	1.22	0.91	4.00	3.00	1.95	2.34	6.40	7.68	0.13	0.42
80	1.63	1.22	5.33	4.00	2.60	3.12	8.53	10.24	0.17	0.56
100	2.03	1.52	6.67	5.00	3.25	3.90	10.67	12.80	0.21	0.70
120	2.44	1.83	8.00	6.00	3.90	4.68	12.80	15.36	0.25	0.83
140	2.84	2.13	9.33	7.00	4.55	5.46	14.93	17.92	0.30	0.97
160	3.25	2.44	10.67	8.00	5.20	6.24	17.07	20.48	0.34	1.11
190	3.86	2.90	12.67	9.50	6.18	7.41	20.27	24.32	0.40	1.32
230	4.67	3.51	15.33	11.50	7.48	8.97	24.53	29.44	0.49	1.60
280	5.69	4.27	18.67	14.00	9.10	10.92	29.87	35.84	0.59	1.95
300	6.10	4.57	20.00	15.00	9.75	11.70	32.00	38.40	0.64	2.09

Installation

Adjusting Projection Image Size (W460)

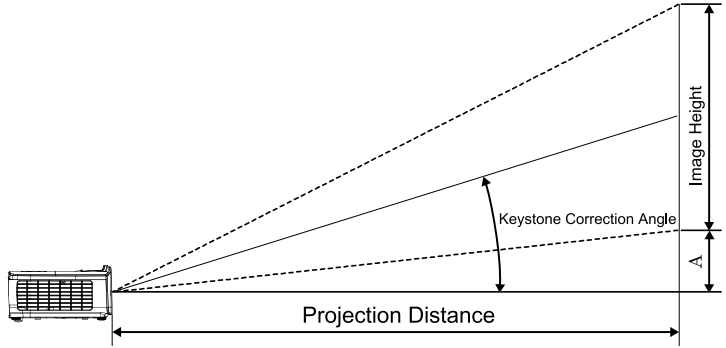

Diagonal length (inch) size of 16:10 Screen	Screen Size W X H (16:10)				Projection distance (D)				Offset (A)	
	(m)		(feet)		(m)		(feet)		(m)	(feet)
	Width	Height	Width	Height	Wide	Tele	Wide	Tele		
30	0.65	0.40	2.12	1.32	0.83	0.99	2.71	3.26	0.05	0.15
40	0.86	0.54	2.83	1.77	1.10	1.32	3.62	4.34	0.06	0.20
60	1.29	0.81	4.24	2.65	1.65	1.99	5.43	6.51	0.09	0.30
80	1.72	1.08	5.65	3.53	2.21	2.65	7.24	8.68	0.12	0.40
100	2.15	1.35	7.07	4.42	2.76	3.31	9.05	10.85	0.15	0.50
120	2.58	1.62	8.48	5.30	3.31	3.97	10.85	13.03	0.18	0.60
140	3.02	1.88	9.89	6.18	3.86	4.63	12.66	15.20	0.21	0.70
160	3.45	2.15	11.31	7.07	4.41	5.29	14.47	17.37	0.24	0.80
190	4.09	2.56	13.43	8.39	5.24	6.29	17.19	20.62	0.29	0.95
230	4.95	3.10	16.25	10.16	6.34	7.61	20.80	24.97	0.35	1.15
280	6.03	3.77	19.79	12.37	7.72	9.26	25.33	30.39	0.43	1.40
300	6.46	4.04	21.20	13.25	8.27	9.93	27.14	32.56	0.46	1.50

Installation

Adjusting Projection Image Size (W460ST)

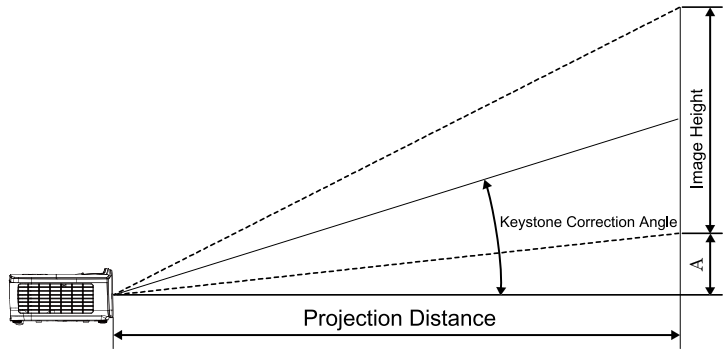

English



Diagonal length (inch) size of 16:10 Screen	Screen Size W X H (16:10)				Projection distance (D)		Offset (A)	
	(m)		(feet)		(m)	(feet)		
	Width	Height	Width	Height	ST	ST	(m)	(feet)
30	0.65	0.40	2.12	1.32	0.34	1.11	0.05	0.15
40	0.86	0.54	2.83	1.77	0.45	1.48	0.06	0.20
60	1.29	0.81	4.24	2.65	0.68	2.23	0.09	0.30
80	1.72	1.08	5.65	3.53	0.90	2.97	0.12	0.40
100	2.15	1.35	7.07	4.42	1.13	3.71	0.15	0.50
120	2.58	1.62	8.48	5.30	1.36	4.45	0.18	0.60
140	3.02	1.88	9.89	6.18	1.58	5.19	0.21	0.70
160	3.45	2.15	11.31	7.07	1.81	5.94	0.24	0.80
190	4.09	2.56	13.43	8.39	2.15	7.05	0.29	0.95
230	4.95	3.10	16.25	10.16	2.60	8.53	0.35	1.15
280	6.03	3.77	19.79	12.37	3.17	10.39	0.43	1.40
300	6.46	4.04	21.20	13.25	3.39	11.13	0.46	1.50

User Controls

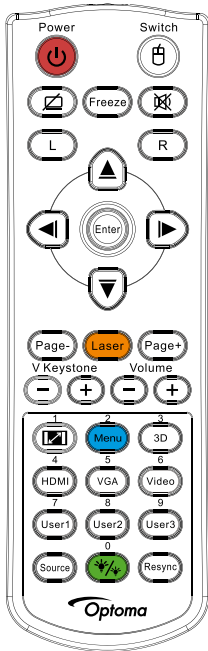
Remote Control



Using the Remote Control

Power On/Off	Refer to the "Powering Off the Projector" on page 15. Refer to the "Powering On the Projector" on page 14.
 /Switch	When connecting your PC to the projector through USB, press "Mouse Switch" to activate/ inactivate the mouse mode and control your PC using the remote.
	Display blank & Audio mute
Freeze	Freeze
	Mute
L	USB mouse Left click
R	USB mouse Right click
Four Directional Select Keys	<ol style="list-style-type: none"> Use ▲▼◀▶ to select items or make adjustments to your selection. In the mouse mode, use ▲▼◀▶ as emulation of directional keys.
Enter	<ol style="list-style-type: none"> Confirm your item selection. In the mouse mode, as emulation keyboard enter key.
Page-	Page Down key for emulation of USB keyboard via USB when OSD off
Laser	Press Laser to operate the on-screen pointer. DO NOT POINT IN EYES.
Page+	Page Up key for emulation of USB keyboard via USB when OSD off
V Keystone +/-	Adjusts image distortion caused by tilting the projector. (±40 degrees for WXGA/1080P, ±20 degrees for 1080p short throw)
Volume +/-	Press "Volume +/-" to adjust volume.

Note

Due to the difference in applications for each country, some regions may have different accessories.



Note

Due to generic remote, function is model dependent.

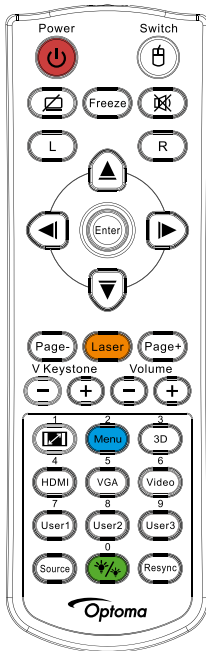
User Controls



Using the Remote Control

 /1	Refer to the  "Aspect Ratio" on page 30.
Menu/2	Press "Menu" to launch the on-screen display (OSD) menu. To exit OSD, press "Menu" again.
3D/3	Press "3D" to turn on/off 3D menu.
HDMI/4	Press "HDMI" to choose HDMI source.
VGA/5	Press "VGA" to choose source from VGA- IN connector.
Video/6	Press "Video" to choose Composite video source.
User 1/7	Refer to the "User1 / User2 / User3" on page 48
User 2/8	Refer to the "User1 / User2 / User3" on page 48
User 3/9	Refer to the "User1 / User2 / User3" on page 48
 /0	Brightness mode menu on/off
Source	Press "Source" to search for source.
Re-sync	Automatically synchronizes the projector to the input source.

Note

Due to the difference in applications for each country, some regions may have different accessories.

Note

Remote control number is for password used.

Note

Due to generic remote, function is model dependent.

User Controls

On-screen Display Menu

The Projector has multilingual On-screen Display menus that allow you to make image adjustments and change a variety of settings. The projector will automatically detect the source.

How to operate

1. To open the OSD menu, press **Menu** (**Menu**) button on the Remote Control or Control Panel.
2. When OSD is displayed, use **▲▼** keys to select any item in the main menu. While making a selection on a particular page, press **▶** or **Enter** (**Enter**) button to enter sub menu.
3. Use **▲▼** keys to select the desired item and use **▶** or **Enter** (**Enter**) button to view further settings. Adjust the settings by using **◀▶** key.
4. Select the next item to be adjusted in the sub menu and adjust as described above.
5. Press **▶** or **Enter** (**Enter**) button to confirm.
6. To exit, press **Menu** (**Menu**) button again. The OSD menu will close and the projector will automatically save the new settings.

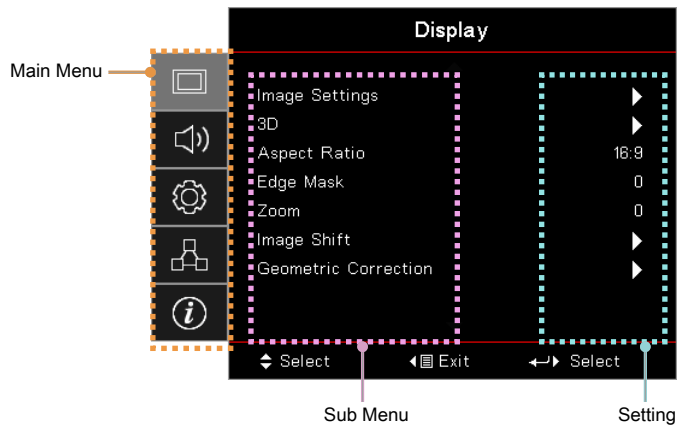

User Controls

Menu Tree

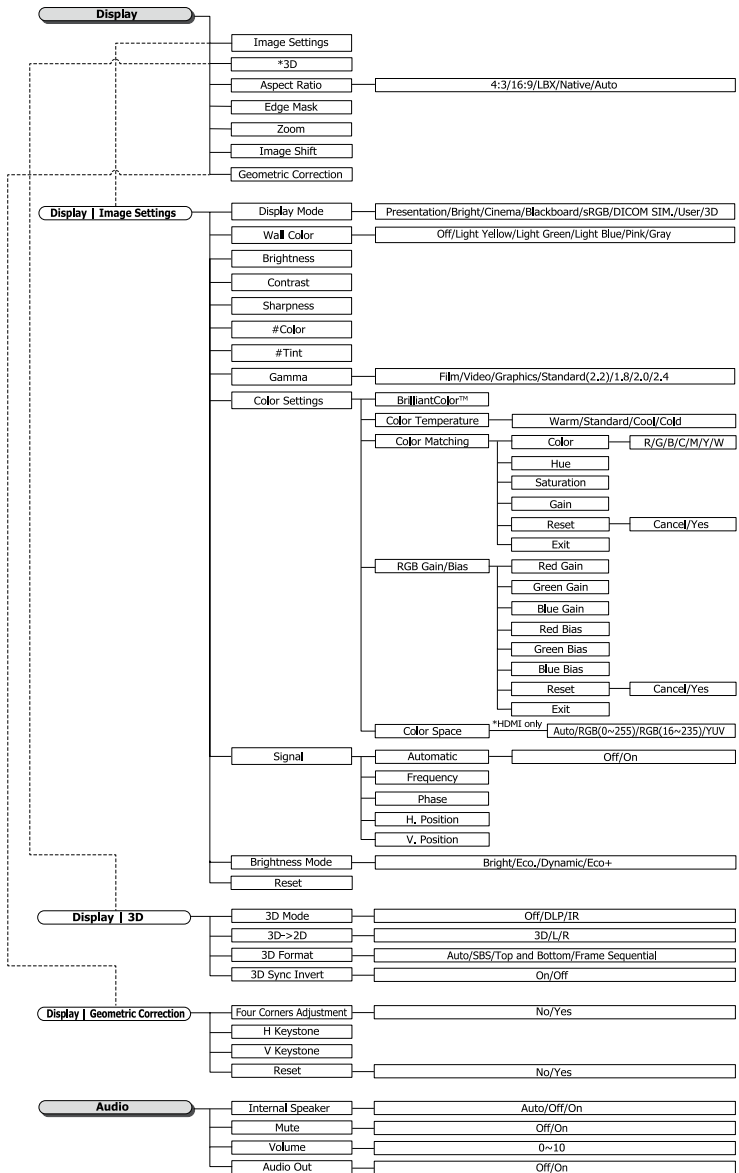

Note

- (#) “Color” and “Tint” is only supported in for YUV video sources.
- (*) “3D” is only available when a compatible signal is supplied.

User Controls

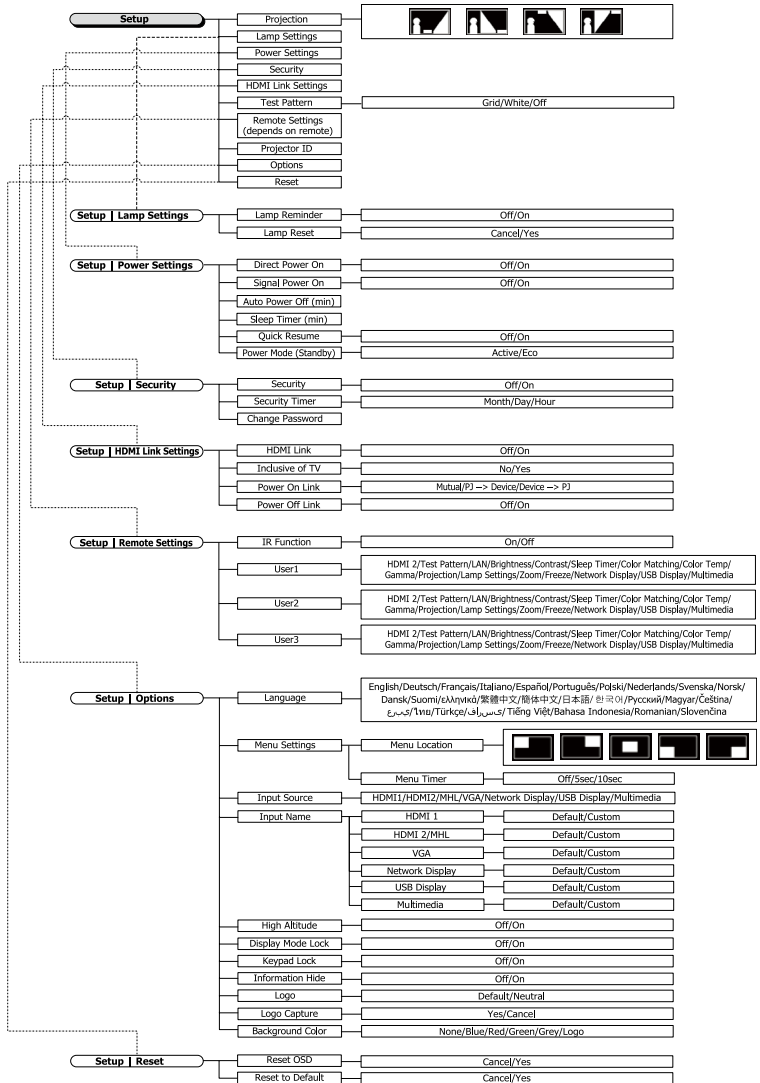

User Controls

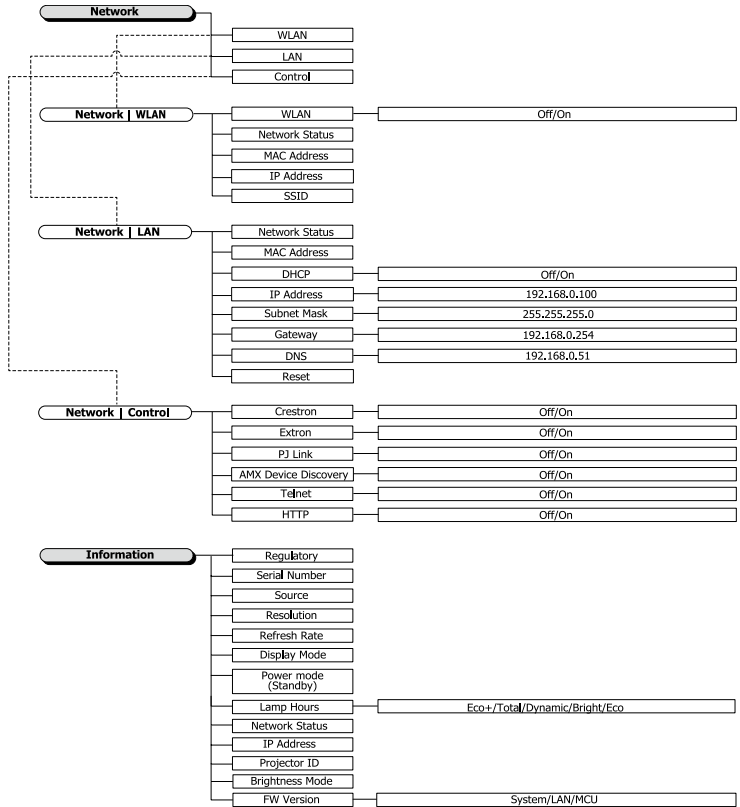

User Controls

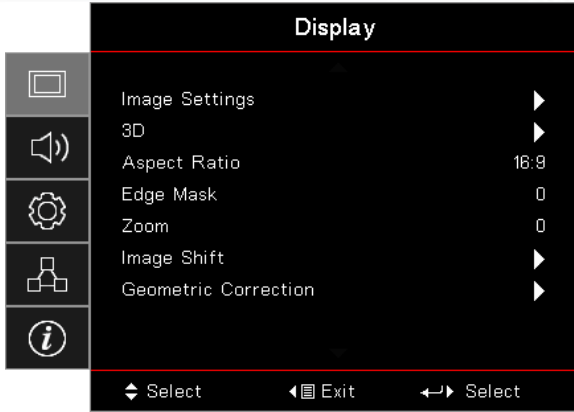

Display

Image Settings

Enter the Image Settings menu. See page 32 for more details.

3D

Enter the 3D menu. See page 34 for more details.

Aspect Ratio

Use this function to choose your desired aspect ratio.

- ▶ 4:3: This format is for 4x3 input sources not enhanced for Wide screen TV.
- ▶ 16:9: This format is for 16x9 input sources, like HDTV and DVD enhanced for Wide screen TV.
- ▶ LBX: This format is for non-16x9, letterbox source and for users who use an external 16x9 lens to display 2.35:1 aspect ratio using full resolution.
- ▶ Native: Depends on the resolution of the input source – No scaling is performed.
- ▶ Auto: Automatically selects the appropriate format.

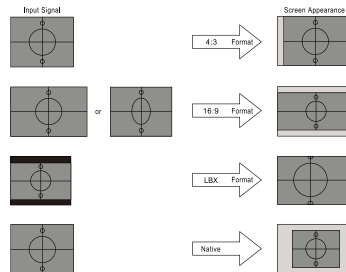

WXGA/1080P

Edge Mask

Edge Mask function removes the noise in a video image. Edge Mask the image to remove video encoding noise on the edge of video source.

Zoom

- ▶ Press ◀ to reduce the size of the image.
- ▶ Press ▶ to magnify an image on the projected screen.

Image Shift

Shifts the projected image position horizontally or vertically.

- ▶ Press ◀▶ to move the image horizontally on the projected screen.
- ▶ Press ▲▼ to move the image vertically on the projected screen.

Geometric Correction

Enter the Geometric Correction menu. See page 35 for more details.

User Controls

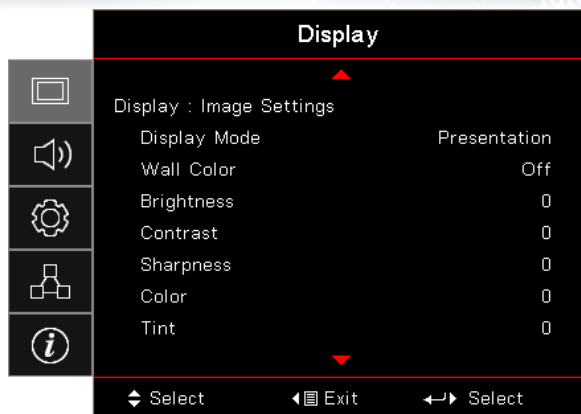

Display / Image Settings

Display Mode

There are many factory presets optimized for various types of images.

- ▶ Presentation: Good color and brightness from PC input.
- ▶ Bright: Maximum brightness from PC input.
- ▶ Cinema: For home theater.
- ▶ sRGB: Standardised accurate color.
- ▶ Blackboard: This mode should be selected to achieve optimum color settings when projecting onto a blackboard (green).
- ▶ DICOM SIM: This display mode simulates the grayscale/gamma performance of equipment used for “Digital Imaging and Communications in Medicine” (DICOM).

Important: This mode should NEVER be used for medical diagnosis, it is for education/training purposes only.

- ▶ User: User’s own settings.
- ▶ 3D: User adjustable setting for 3D viewing.

Wall Color

Use this function to obtain an optimized screen image according to the wall color.

Brightness

Adjust the brightness of the image.

- ▶ Press ◀ to darken image.
- ▶ Press ▶ to lighten the image.

Contrast

The contrast controls the degree of difference between the lightest and darkest parts of the picture.

- ▶ Press ◀ to decrease the contrast.
- ▶ Press ▶ to increase the contrast.

Sharpness

Adjusts the sharpness of the image.

- ▶ Press ◀ to decrease the sharpness.
- ▶ Press ▶ to increase the sharpness.

Color

Adjusts a video image from black and white to full color saturation.

- ▶ Press ◀ to decrease the amount of color in the image.
- ▶ Press ▶ to increase the amount of color in the image.

Tint

Adjusts the color balance of red and green.

- ▶ Press ◀ to increase the amount of green in the image.
- ▶ Press ▶ to increase the amount of red in the image.

Gamma

Choose the Gamma type from Film, Video, Graphics, Standard (2.2), 1.8, 2.0, 2.4.

Color Settings

Enter the Image Settings menu. See page 36 for more details.

Signal

Enter the Signal menu. Set projector signal properties. The function is available when input source is support VGA. See page 37 for more information.

Brightness Mode

Adjust the brightness mode settings for lamp-based projectors.

- ▶ Bright: Choose "Bright" to increase the brightness.
- ▶ Eco.: Choose "Eco." to dim the projector lamp which will lower power consumption and extend the lamp life.
- ▶ Dynamic: Choose "Dynamic" to dim the lamp power which will be based on brightness level of the content and adjust lamp power consumption between 100% and 30% dynamically. The lamp life will be extended.
- ▶ Eco+: When Eco+ mode is activated, the brightness level of the content is automatically detected to significantly reduced lamp power consumption (up to 70%) during periods of inactivity.

User Controls

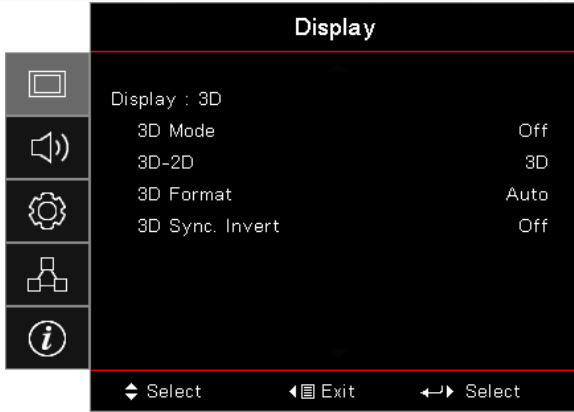

Display / 3D

3D Mode

- ▶ DLP Link: Select DLP Link to use optimized settings for DLP Link 3D Glasses.
- ▶ IR: Select IR to use optimized settings for IR-based 3D images.
- ▶ Off: Select "Off" to turn off 3D mode.



3D settings would be saved after adjustment.

3D→2D

Press ◀▶ to select projector display 3D content in 2D (Left) or 2D(Right) without using 3D glasses to enjoy 3D content. This setting can also be used for dual projector passive 3D installations.

3D Format

- ▶ Auto: When a 3D identification signal is detected, the 3D format is selected automatically. (For HDMI 1.4 3D sources only)
- ▶ SBS: Display 3D signal in Side-by-Side format.
- ▶ Top and Bottom: Display 3D signal in Top and Bottom format.
- ▶ Frame Sequential: Display 3D signal in Frame Sequential format.

3D Sync. Invert

Press ◀▶ to enable or disable the 3D Sync invert function to invert images.

User Controls

Display / Geometric Correction

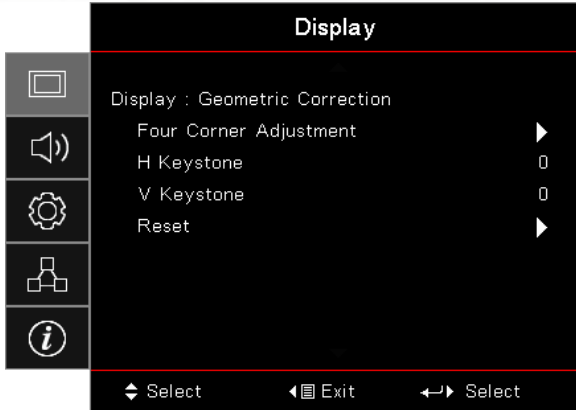

Four Corners Adjustment

Select "Yes" for Geometric Correction adjustment.

Use ▲▼◀▶ key select corner for adjustment. Press  (**Enter**) button and adjust corners by ▲▼◀▶.

H Keystone

Select "Yes" for Geometric Correction adjustment.

Press ◀▶ to compensate for horizontal images distortion when the projector is positioned at an angle to the screen.

V Keystone

Select "Yes" for Geometric Correction adjustment.

Press ▶▶ to compensate for vertical images distortion when the projector is positioned at an angle to the screen.

Reset

Reset all Geometric Correction values to the factory default.

User Controls

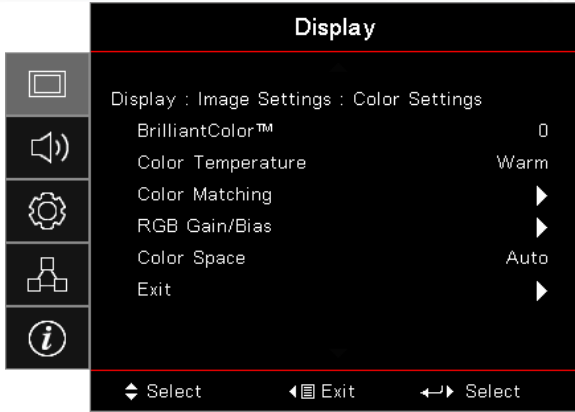

Display / Image Settings / Color Setting

BrilliantColor™

This adjustable item utilizes a new color-processing algorithm and system level enhancements to enable higher brightness while providing true, more vibrant colors in picture. The range is from 1 to 10. If you prefer a stronger enhanced image, adjust toward the maximum setting. For a smoother, more natural image, adjust toward the minimum setting.

Color Temp

Adjust the color temperature. Cold temperature, the screen looks colder; with Warm temperature, the screen looks warmer.

Color Matching

Enter the Color Matching menu. See page 38 for more details.

RGB Gain/Bias

- ▶ RGB Gain/Bias: This settings allows to configure the brightness (gain) and contrast (bias) of an image.
- ▶ Reset: Return the factory default settings for RGB gain/bias.

Color Space

Select an appropriate color matrix type from AUTO, RGB, YUV.

- ▶ For HDMI only: Select color matrix from Auto, RGB (0-255), RGB (16-235), YUV.

User Controls

Display / Image Settings / Signal

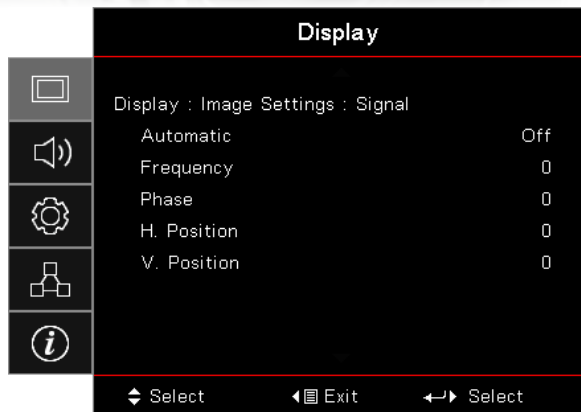

Automatic

Set Automatic to On or Off to lock or unlock the Phase and Frequency features.

- ▶ Disable: Off auto lock.
- ▶ Enable: On auto lock.

Frequency

Change the display data frequency to match the frequency of your computer's graphics card. If you experience a vertical flickering bar, use this function to make an adjustment.

Phase

Phase synchronizes the signal timing of the display with the graphics card. If you experience an unstable or flickering image, use this function to correct it.

H. Position

- ▶ Press ◀ to move the image left.
- ▶ Press ▶ to move the image right.

V. Position

- ▶ Press ◀ to move the image down.
- ▶ Press ▶ to move the image up.

User Controls

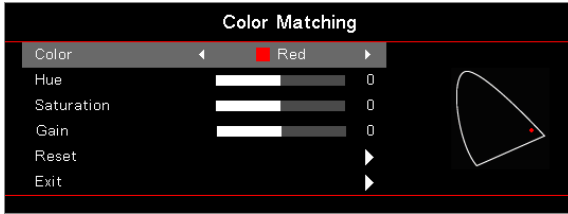

Display / Image Settings / Color Setting / Color Matching

Colors (Except White)

Press ▲▼ to select a color and press  (**Enter**) button to adjust the hue, saturation, and gain settings.

Press ▲▼ to select Hue, Saturation, or Gain and press ◀▶ to adjust the settings.

Note

- Green, Blue, Cyan, Yellow, Magenta can be separate adjust by each color HSG.
- White can be adjust Red, Green, Blue color by each.

White

Press ▲▼ to select White and press  (**Enter**) button.

Press ▲▼ to select Red, Green, or Blue and press ◀▶ to adjust the settings.

Reset

Reset all Color Setting values to the factory default.

Exit

Exit the Color Matching menu.

User Controls

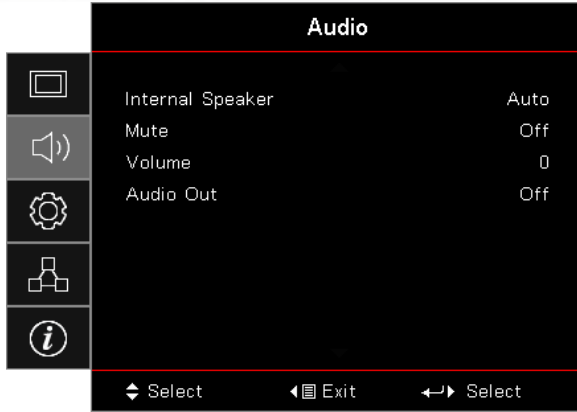

Audio

Internal Speaker

- ▶ Auto: Adjust the internal speaker automatically.
- ▶ Off: Turn off the internal speaker.
- ▶ On: Turn on the internal speaker.

Mute

Toggle the audio on or off.

- ▶ Off: The speaker volume and audio out are turned on.
- ▶ On: The speaker volume and audio out are turned off.

Volume

Press ◀ to decrease the volume.

Press ▶ to increase the volume.

Audio Out

Press ◀▶ to select audio source out.



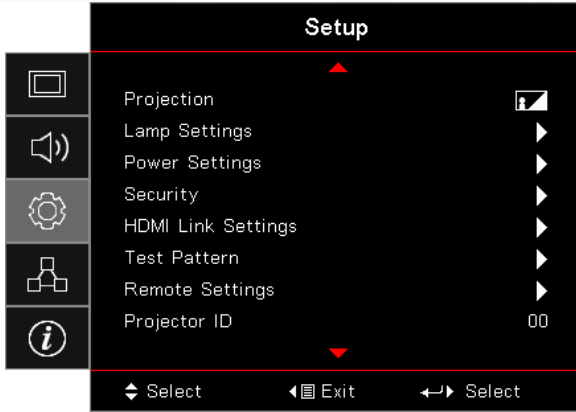

User Controls



Setup

Projection

Select projection method:

- ▶  Front Desktop
The factory default setting.
- ▶  Rear Desktop
When you select this function, the projector reverses the image so you can project from behind a translucent screen.
- ▶  Ceiling-top
When you select this function, the projector turns the image upside down for ceiling-mounted projection.
- ▶  Rear-top
When you select this function, the projector reverses and turns the image upside down at same time. You can project from behind a translucent screen with ceiling mounted projection.

Lamp Settings

Enter the Lamp Setting menu. See page 42 for more details.

Power Settings

Enter the Power Settings menu. See page 43 for more information.

Security

Enter the Security menu. See page 45 for more information.

HDMI Link Settings

Enter the HDMI Link Settings menu. See page 47 for more information.

User Controls

Test Pattern

Display a test pattern. There are Grid, White and None.

Remote Settings

Enter the Remote Settings menu. See page 48 for more information.

Projector ID

Select a two digit projector ID from 00 through 99.

Options

Enter the Options menu. See page 49 for more information.

Reset

Reset all Options to default factory settings.

User Controls

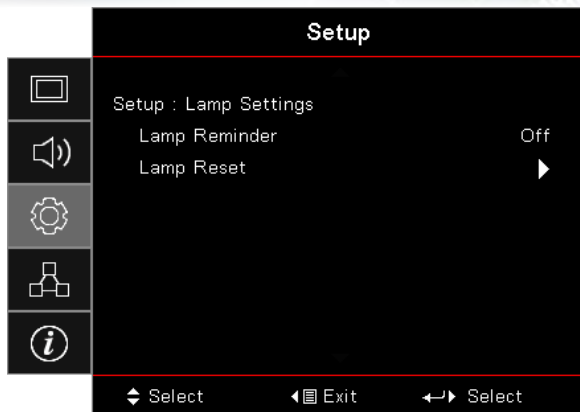

Setup / Lamp Settings

Lamp Reminder

Enable or disable the lamp life span reminder.

- ▶ On: A warning message displays when remaining lamp life is less than 30 hours.
- ▶ Off: No warning message displays.

Lamp Reset

After replacing the lamp, reset the lamp counter to accurately reflect the new lamp's life span.

1. Select Lamp Reset.
A confirmation screen displays.
2. Select Yes to reset the lamp counter to zero.

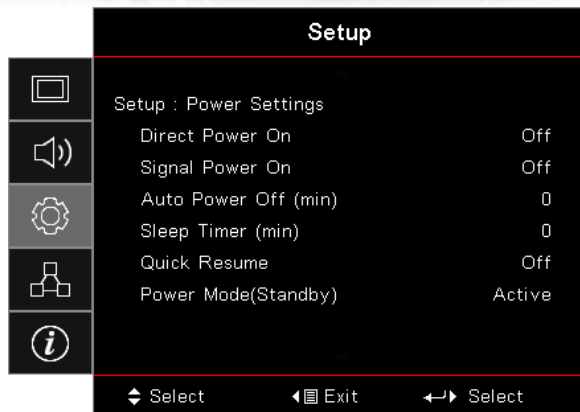

Setup / Power Settings

Direct Power On

Enable or disable Direct Power On.

- ▶ On: The projector powers on automatically when AC power is supplied.
- ▶ Off: The projector must be powered on as normal.

Signal Power On

Enable or disable Signal Power On.

- ▶ On: The projector powers on automatically when an active signal is detected.
- ▶ Off: Disable the power on trigger by active signal is detected.



1. Only available on Standby Mode is Active.
2. If projector is turned off with keeping input the signal source (the last image source showing on screen), it will not re-start unless:
 - a. Terminate the last image source and input any signal source again.
 - b. Unplug and re-plug the projector power again.
3. Signal power on will ignore "source lock" setting.

Auto Power Off (min)

Set the Auto Power Off interval. The projector powers off the lamp after 0 minutes of no signal by default. The warning message is displayed 60 seconds before power off.

User Controls

Sleep Timer (min)

Set the Sleep Timer interval. The projector powers off after the specified time period of inactivity (regardless of signal). The warning message is displayed 60 seconds before power off.



Projector won't really be 100% turn off unless end-user wait 100 sec.

Quick Resume

If Quick Resume is On, the projector can resume operating soon provided the projector is turned back on within 100 seconds of being turned off.

Power Mode (Standby)

- ▶ Eco.: Choose "Eco." to save power dissipation further < 0.5W.
- ▶ Active: Choose "Active" to return to WOL(Wake On Lan) mode .



When Power Mode (Standby) is set to Eco., the VGA & Audio pass-through and RJ45 would be deactivated. Limited functionality is available on RS232 control.

There is some process of switching signals while attempting normal power on in active mode, thus a few seconds transition with power LED indicator changing from orange color to red will be shown before the device can be operated again.

User Controls

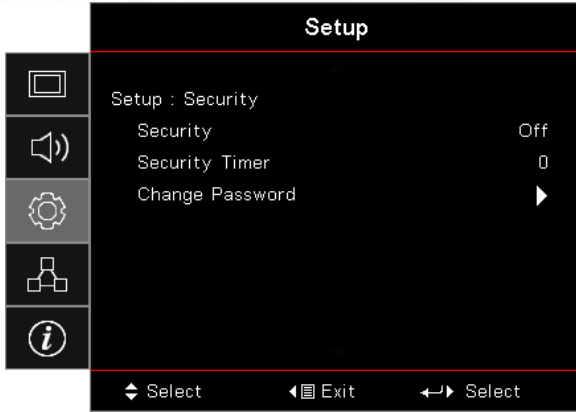

Setup / Security



The default password:
1, 2, 3, 4.

Security

Enable or disable the security password.

- ▶ On: The current password is required to power on the projector and access the Security menu.
- ▶ Off: No password is required after system power up.

When security is enabled, the following screen displays at startup and before access to the Security menu is allowed:

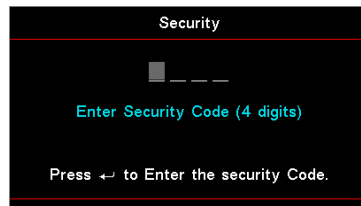

Security Timer

Enter the Security Timer sub menu.

Enter the Months, Days, and hours that the projector can be used without entering the password. Exiting to the Setup menu activates the Security Timer.

Once activated, the projector requires a password on the specified dates and times to allow power on and access to the security menu.

User Controls



If the incorrect password is entered three times, the device auto shutdowns after 10 seconds.

If the projector is in use and the Security Timer is active, the following screen displays 60 seconds before the password is required.

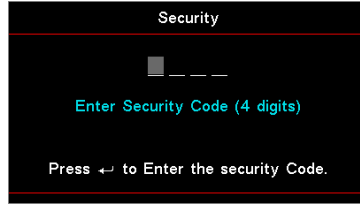

Change Password

Use this submenu to change the security password for the projector.

1. Select Change Password from the Security submenu. The Confirm Change Password dialog box displays.
2. Select Yes.
3. Enter the default password <1> <2> <3> <4>.
A second password screen displays.

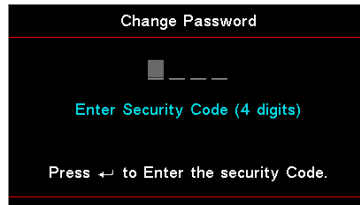

4. Enter the new password twice for verification.



If the new passwords do not match, the password screen redisplay.

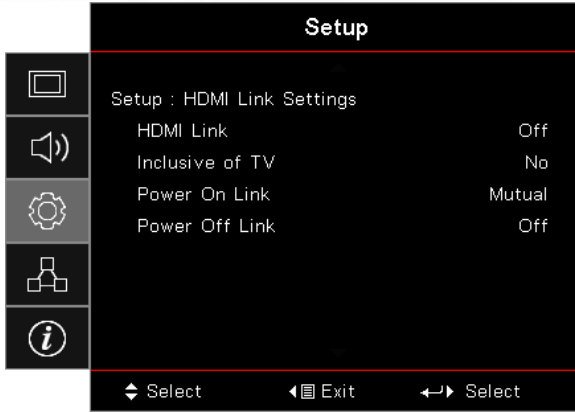

Setup / HDMI Link Settings

Note

When you connect HDMI CEC-compatible devices to the projector with HDMI cables, you can control them on the same power on or power off status using the HDMI Link control feature in the projector's OSD. This lets one device or multiple devices in a group power on or power off via HDMI Link Feature in a typical configuration, your DVD player may be connected to the projector through an amplifier or home theater system.

HDMI Link

Enable/disable the HDMI Link function. The inclusive TV, power on link, and power off link options will only available if the setting is set to "On".

Inclusive of TV

Set to "Yes" if you prefer both TV and projector to be automatically turned off at the same time. To prevent both devices to be turned off at the same time, set the setting to "No".

Power On Link

CEC power on command.

- ▶ Mutual: Both projector and CEC device will be turned on simultaneously.
- ▶ PJ -> Device: The CEC device will be turned on only after the projector is switched on.
- ▶ Device -> PJ: The projector will be switched on only after the CEC device is turned on.

Power Off Link

If the setting is set to "On", both HDMI Link and projector will be automatically turned off at the same time. Set to "Off", both HDMI Link and projector will be not automatically turned off at the same time.

User Controls

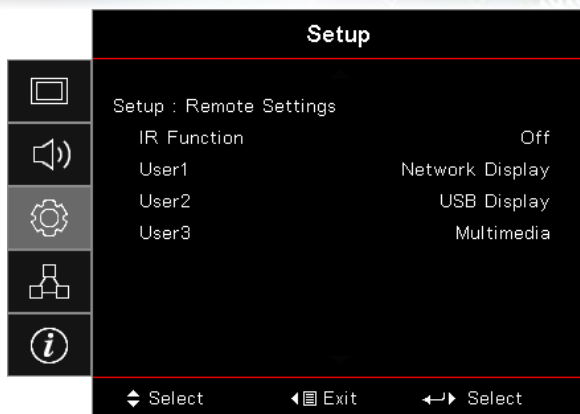

Setup / Remote Settings

IR Function

Enable or Disable projector's IR function.

User1 / User2 / User3

Set User1, User2, User3 key as a hotkey for LAN, Brightness, Contrast, Sleep Timer, Color Matching, Color Temp, Gamma, Projection, Lamp Settings, Zoom, Test Pattern, Freeze, Network Display, USB Display, Multimedia, HDMI2 function.

User Controls

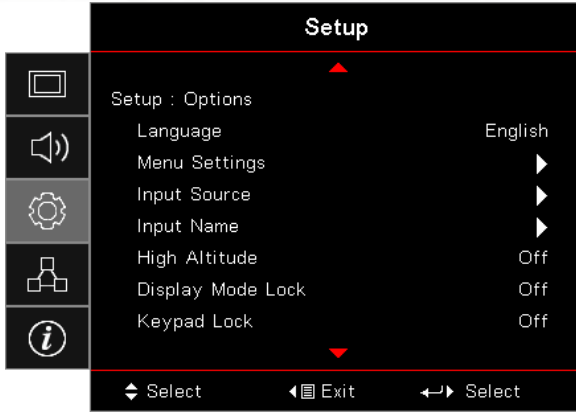

Setup / Options

Language

Enter the Language menu. Select the multilingual OSD menu.

Menu Settings

Set the menu location on the screen and configure menu timer settings.

Input Source

Enter the Input Source submenu. Select the sources to scan for at startup.

Input Name

Use to rename the input function for easier identification. The available options include HDMI1, HDMI2/MHL, VGA, Networkdisplay, USB Display, and Multimedia.

High Altitude

Adjust the fan speed to reflect the environment.

- ▶ On: Increases fan speed for high temperature, humidity, or altitude.
- ▶ Off: Regular fan speed for normal conditions.

Display Mode Lock

Choose “On” or “Off” to lock or unlock adjusting display mode settings.

User Controls



Hold  (Enter) button on keypad for 10 seconds to unlock keypad

Keypad Lock

Lock the buttons on the projector top panel.

- ▶ On: A warning message displays to confirm keypad lock.
- ▶ Off: Projector keypad functions as normal.

Information Hide

Suppress informational messages on the projected screen.

- ▶ On: No status messages appear on screen during operation.
- ▶ Off: Status messages appear as normal on screen during operation.

Logo

Select the screen to display during startup.

- ▶ Default: The supplied default startup screen.
- ▶ Neutral: It is Background Color.

Logo Capture

Capture a displayed screen to use as the startup screen.

1. Display the desired screen on the projector.
2. Select Logo Capture from the Advanced menu.
A confirmation screen displays.
3. Select Yes. Screen capture in progress will display.
When finished, Screen capture Succeeded will display.
The captured screen is saved as User in the logo menu.



Only one startup screen can be saved at once. Subsequent captures overwrite previous files limited in 1920 x 1200 (Refer Appendices Timing Table)

Background Color

Select the desired background color for the projected image when no source is detected.

Reset

- ▶ Reset OSD: Return the factory default settings for OSD menu settings.
- ▶ Reset to Default: Return the factory default settings for Setup menu settings.



User Controls



Setup / Options / Language

English

Language

Choose the multilingual OSD menu. Press  (**Enter**) button into the sub menu and then use the Up () or Down () key to select your preferred language.

User Controls



Setup / Options / Menu Settings

Menu Location

Select the menu location on the display screen.

Menu Timer

Set the duration where the OSD menu stays visible on the screen.

User Controls

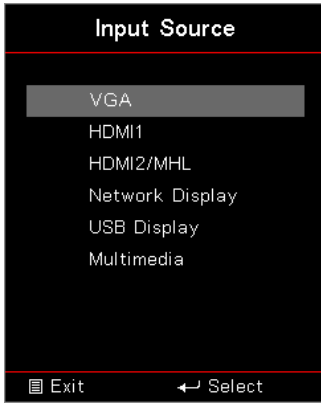

Setup / Options / Input Source

Input Source

Use this option to select input sources. Press ▲▼ to select a source. Press  (Enter) button to finalize the selection.

User Controls

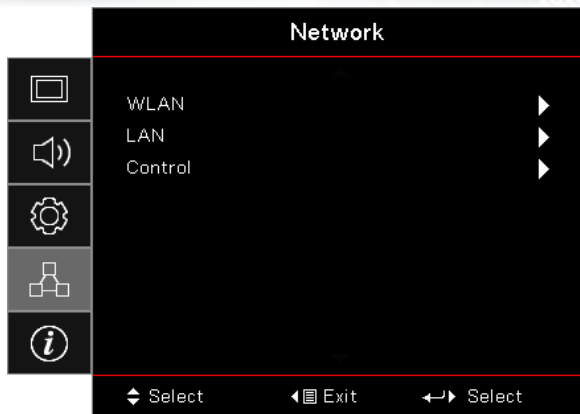

Network

WLAN

- ▶ WLAN: Off/On
- ▶ Network Status: Read only.
- ▶ MAC Address: Read only.
- ▶ IP Address: Read only.
- ▶ SSID: Read only.

LAN

Enter the LAN menu. See page 55 for more information.

Control

Enter the Control menu. See page 56 for more information.

User Controls

Network / LAN

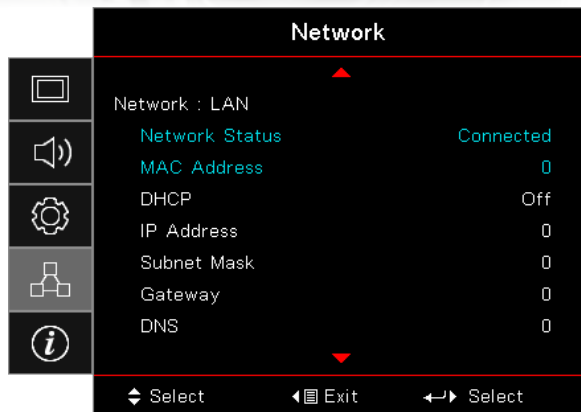

Network sub-menu can only be accessed if a network cable is connected.

If the connection is successful, the OSD display will show the following dialogue box.

- ▶ Network State: To display network information.
- ▶ MAC Address: Read only.
- ▶ DHCP:
 - On: Assign an IP address to the projector from the DHCP server automatically.
 - Off: Assign an IP address manually.
- ▶ IP Address: Select an IP address.
- ▶ Subnet Mask: Select subnet mask number.
- ▶ Gateway: Select the default gateway of the network connected to the projector.
- ▶ DNS: Select DNS number.
- ▶ Apply: Press  (**Enter**) button to apply the selection.

User Controls

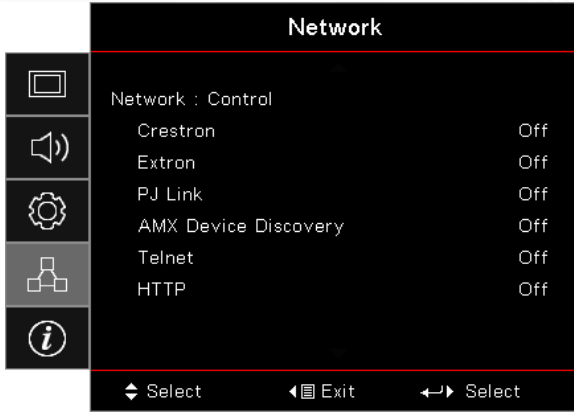

Network / Control

Crestron

Press ◀▶ to check to enable/disable Crestron.

Extron

Press ◀▶ to check to enable/disable Extron.

PJ Link

Press ◀▶ to check to enable/disable PJ Link.

AMX Device Discovery

Press ◀▶ to check to enable/disable AMX Device Discovery.

Telnet

Press ◀▶ to check to enable/disable Telnet.

HTTP

Press ◀▶ to check to enable/disable HTTP.

User Controls

Information

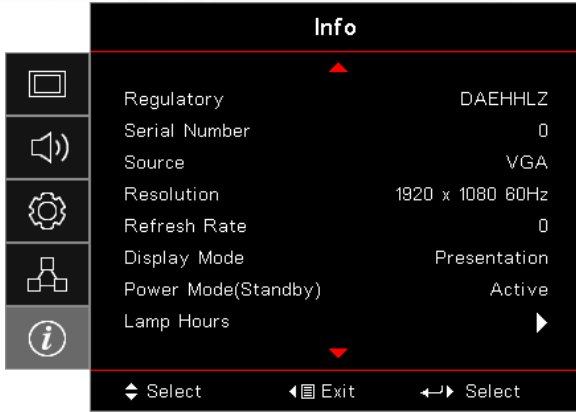

View the projector information as listed below:

- ▶ Regulatory
- ▶ Serial Number
- ▶ Source
- ▶ Resolution
- ▶ Refresh Rate
- ▶ Display Mode
- ▶ Power Mode (Standby)
- ▶ Lamp Hours
- ▶ Network Status
- ▶ IP Address
- ▶ Projector ID
- ▶ Brightness Mode
- ▶ FW Version

Media

How to set up File Type for Multimedia with USB



1. A USB flash disk must be plugged into the projector if you want to use the multimedia USB function.
2. Please don't connect USB port for camera since it would be exist compatibility problem.

Follow these steps to playback the Photo, Video, or Music files on your projector:

1. Connect the power cable with AC adapter and turn on the projector by pressing the Power button.

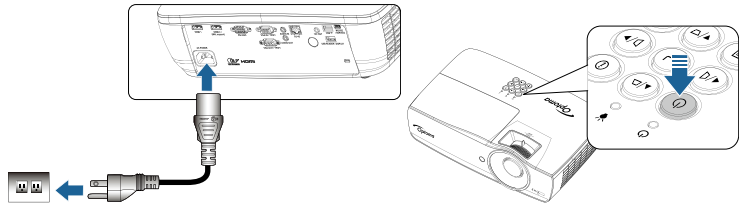

2. Plug in a **USB flash disk** to your projector.

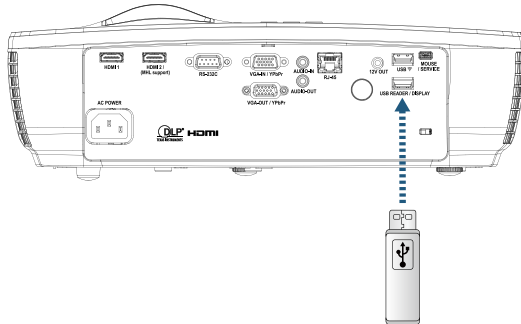

User Controls

To open the Media Menu, press  (**Source**) button on the remote control or keypad and select.

The Multimedia menu opens.

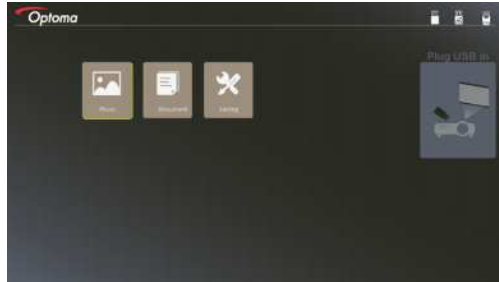

3. Access the USB menu and select the multimedia files: **Photo**, or **Document**. Or select the Settings option to change settings for **Photo**, or **Document**.
4. Select the file you want to open.

The Multimedia Setting allow you to change settings for Display ratio and Interval time of the Photo and Document.

User Controls

Mirroring the Screen of the Portable Device (with the Optional USB Wi-Fi Dongle)

Follow these steps to mirror the screen of your portable device:

1. Connect the power cable with AC adapter and turn on the projector by pressing the Power button.

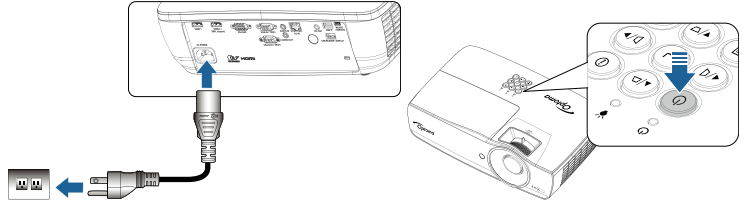

2. Depending on the operating system of your mobile device, open the App Store (iOS) or Google Play (Android) and install the HD-Cast Pro app on your mobile device.

If you are using a laptop, download HD-Cast Pro app from www.optoma.com/hdcastpro website.

3. Plug in a Wi-Fi dongle (Optional) to your projector.

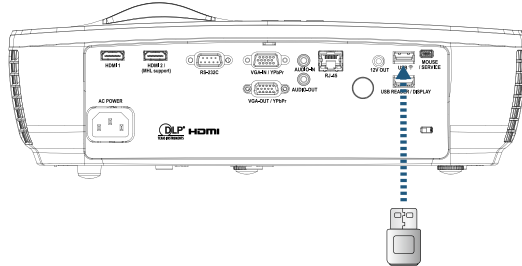

4. Connect your portable device via Wi-Fi to the projector. An example connection parameters are as follows:

- ▶ SSID of the projector: HD-CastPro_XXXXXXXX
- ▶ Wi-Fi password: XXXXXXXX

Note

The projector SSID and Wi-Fi password varies depending on the connected Wi-Fi dongle.

User Controls

5. Open HD Cast Pro app on your portable device.
The following screen opens.

Android

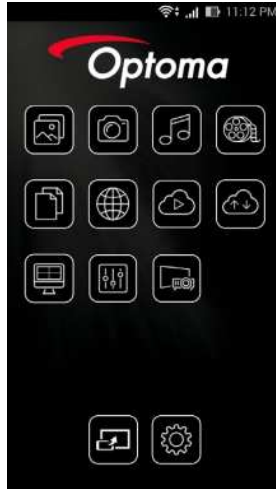

Windows



6. Select HDMirror (Android) from the menu to start mirroring the screen of your portable device.

User Controls

LAN_RJ45

Note

- Projector connects to LAN, please use Ethernet Normal Cable.
- Peer-to-peer (PC connects to Projector directly), please use Ethernet Crossover Cable.

For simplicity and ease of operation, the Optoma projector provides diverse networking and remote management features.

The LAN/RJ45 function of the projector through a network, such as remotely manage: Power On/Off, Brightness and Contrast settings. Also, projector status information, such as: Video-Source, Sound-Mute, etc.

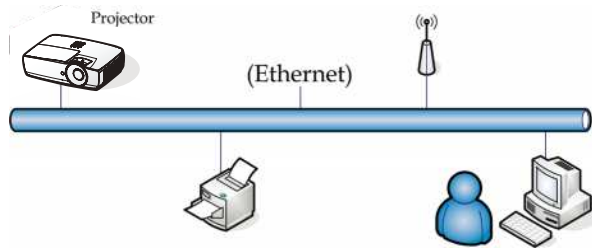

Wired LAN Terminal functionalities

The projector can be controlled by a PC (Laptop) or other external device via LAN/RJ45 port and compatible with Crestron / Extron / AMX (Device Discovery) / PLink.

- ▶ Crestron is a registered trademark of Crestron Electronics, Inc. of the United States.
- ▶ Extron is a registered trademark of Extron Electronics, Inc. of the United States.
- ▶ AMX is a registered trademark of AMX LLC of the United States.
- ▶ PLink applied for trademark and logo registration in Japan, the United States of America, and other countries by JBMIA.

Supported External Devices

This projector is supported by the specified commands of the Crestron Electronics controller and related software (ex, RoomView®).

<http://www.crestron.com/>

This projector is compliant to support Extron device(s) for reference.

<http://www.extron.com/>

This projector is supported by AMX (Device Discovery).

<http://www.amx.com/>

User Controls

This projector supports all commands of PJLink Class1 (Version 1.00).

<http://pjlink.jbmia.or.jp/english/>

For more detail of information about the diverse types of external devices which can be connected to the LAN/RJ45 port and remote/control the projector, as well as the related control commands supporting for each external device, kindly please get contact with the Support-Service directly.

LAN RJ45

1. Connect an RJ45 cable to RJ45 ports on the projector and the PC (Laptop).

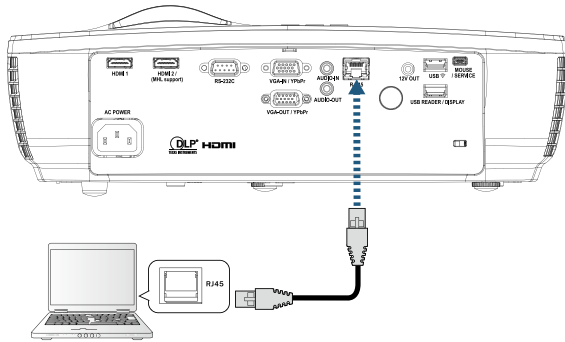

2. On the PC (Laptop), select Start -> Control Panel-> Network Connections.



User Controls

3. Right Click on your Local Area Connection, and select Property.



4. In the Properties window, select the General tab, and select Internet Protocol (TCP/IP).



5. Click Properties.

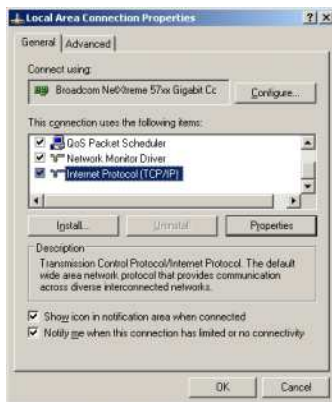

User Controls

6. Fill in the IP address and Subnet mask, then press OK.



7. Press **Menu** (**Menu**) button on the projector.
8. Select OSD-> Network-> Lan.
9. After getting into Network Status, input the following:
 - ▶ DHCP: Off
 - ▶ IP Address: 192.168.0.100
 - ▶ Subnet Mask: 255.255.255.0
 - ▶ Gateway: 192.168.0.254
 - ▶ DNS: 192.168.0.51
 - ▶ DNS2: 8.8.4.4
10. Press **Enter** (**Enter**) button to confirm settings.
11. Open a web browser (ex, Microsoft Internet Explorer with Adobe Flash Player 9.0 or higher).
12. In the Address bar, input the IP address: 192.168.0.100.



User Controls



For more information, please visit <http://www.crestron.com>

13. Press **Enter** (**Enter**) button.

The projector is setup for remote management. The LAN/RJ45 function displays as follows.

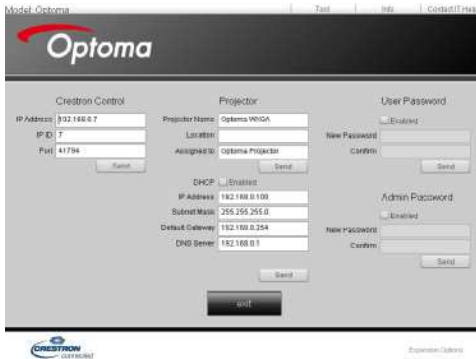

User Controls

RS232 by Telnet Function

Besides projector connected to RS232 interface with “Hyper-Terminal” communication by dedicated RS232 command control, there is alternative RS232 command control way, so called “RS232 by TELNET” for LAN/RJ45 interface.

Quick Start-Guide for “RS232 by TELNET”

Check and get the IP-Address on OSD of the projector.

Make sure that laptop/PC can access the web-page of the projector.

Make sure that “Windows Firewall” setting to be disabled in case of “TELNET” function filtering out by laptop/PC.



1. Start => All Programs => Accessories => Command Prompt.

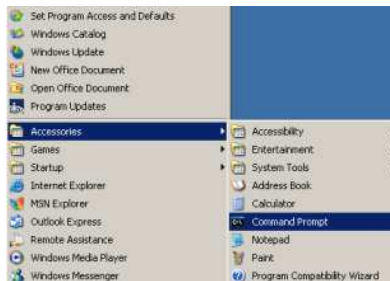

User Controls

2. Input the command format like the below:
`telnet ttt.xxx.yyy.zzz 23` ("Enter" key pressed)
(ttt.xxx.yyy.zzz: IP-Address of the projector)
3. If Telnet-Connection ready, and user can have RS232 command input, then "Enter" key pressed, the RS232 command will be workable.

How to have TELNET enabled in Windows VISTA / 7

By default installation for Windows VISTA, "TELNET" function is not included. But end-user can have it by way of "Turn Windows features On or Off" to be enabled.

1. Open "Control Panel" in Windows VISTA.



2. Open "Programs".

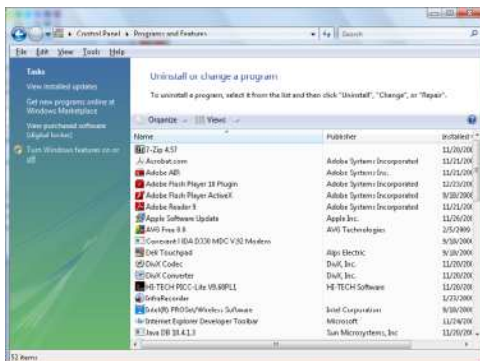

User Controls

3. Select "Turn Windows features on or off" to open.

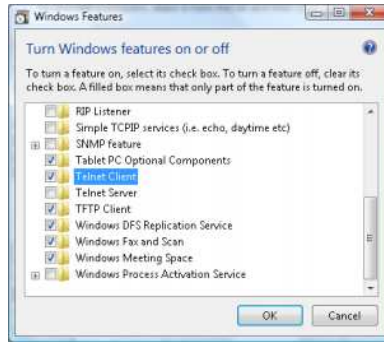

4. Have "Telnet Client" option checked, then press "OK" button.

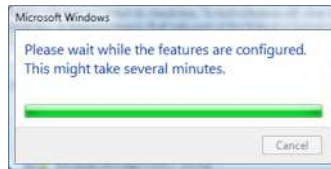

Specsheet for "RS232 by TELNET" :

1. Telnet: TCP.
2. Telnet port: 23 (for more detail, kindly please get contact with the service agent or team).
3. Telnet utility: Windows "TELNET.exe" (console mode).
4. Disconnection for RS232-by-Telnet control normally: Close Windows Telnet utility directly after TELNET connection ready.

Limitation 1 for Telnet-Control: there is less than 50 bytes for successive network payload for Telnet-Control application.

Limitation 2 for Telnet-Control: there is less than 26 bytes for one complete RS232 command for Telnet-Control.

Limitation 3 for Telnet-Control: Minimum delay for next RS232 command must be more than 200 (ms).

(* , In Windows XP built-in "TELNET.exe" utility, "Enter" key pressed will have "Carriage-Return" and "New-Line" code.)

Troubleshooting

If you experience a problem with your projector, please refer to the following information. If a problem persists, please contact your local reseller or service center.

Image

? No image appears on-screen

- ▶ Ensure all the cables and power connections are correctly and securely connected as described in the "Installation" section.
- ▶ Ensure the pins of connectors are not crooked or broken.
- ▶ Check if the projection lamp has been securely installed. Please refer to the "Replacing the Lamp" section.
- ▶ Make sure you have removed the lens cap and the projector is switched on.

? Image is out of focus

- ▶ Make sure the Lens cap is removed.
- ▶ Adjust the Focus Ring on the projector lens.
- ▶ Make sure the projection screen is between the required distance from the projector. See pages 17-23.

? The image is stretched when displaying 16:9 DVD title

- ▶ When you play anamorphic DVD or 16:9 DVD, the projector will show the best image in 16: 9 format on projector side.
- ▶ If you play the LBX format DVD title, please change the format as LBX in projector OSD.
- ▶ If you play 4:3 format DVD title, please change the format as 4:3 in projector OSD.
- ▶ If the image is still stretched, you will also need to adjust the aspect ratio by referring to the following:
- ▶ Please setup the display format as 16:9 (wide) aspect ratio type on your DVD player.

? Image is too small or too large

- ▶ Adjust the zoom lever from the lens.
- ▶ Move the projector closer to or further from the screen.
- ▶ Press **Menu** (Menu) button on the projector panel, go to “Display->Aspect Ratio”.
Try the different settings.

? Image has slanted sides:

- ▶ If possible, reposition the projector so that it is centered on the screen and below the bottom of the screen and use PureShift to make adjustments to the image position.
- ▶ Use “Display->Geometric Correction->V Keystone” from the OSD to make an adjustment.

? Image is reversed

- ▶ Select “Setup->Projection” from the OSD and adjust the projection direction.

Other

? The projector stops responding to all controls

- ▶ If possible, turn off the projector, then unplug the power cord and wait at least 20 seconds before reconnecting power.

? Lamp burns out or makes a popping sound

- ▶ When the lamp reaches its end of life, it will burn out and may make a loud popping sound. If this happens, the projector will not turn on until the lamp module has been replaced. To replace the lamp, follow the procedures in the “Replacing the Lamp” section on page 74.

Appendices

Projector LED Status Indicator

Message	Power LED ⏻ ○ (Red)	Power LED ⏻ ○ (Green)	Temp LED 🔑 ○ (Red)	Lamp LED 💡 ○ (Red)
Standby State	☀️	○	○	○
Power on (Warming)	○	Flashing 0.5 sec off 0.5 sec light	○	○
Power on & Lamp lighting	○	☀️	○	○
Power off (Cooling)	○	Flashing 0.5 sec off 0.5 sec light Back to Red steady light when cooling fan turns off	○	○
Quick Resume(100 secs)	○	Flashing 0.25 sec off 0.25 sec light	○	○
Error (Lamp fail)	Flashing	○	○	☀️
Error (Fan fail)	Flashing	○	Flashing	○
Error (Over Temp)	Flashing	○	☀️	○

Note

Steady light => ☀️

No light => ○

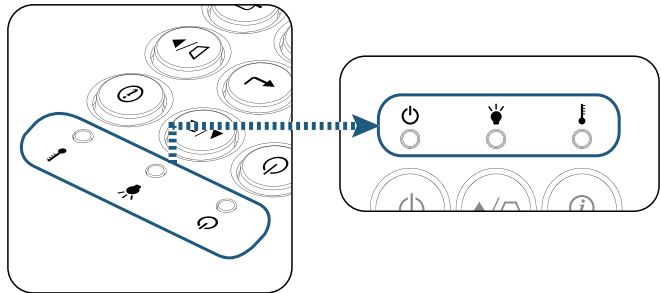

? LED states

? On Screen Messages

- ▶ Fan failed:
The projector will switch off automatically.
- ▶ Over temperature:
The projector will switch off automatically.
- ▶ Replacing the lamp:
Lamp is approaching the end of its rated life.
Replacement suggested.

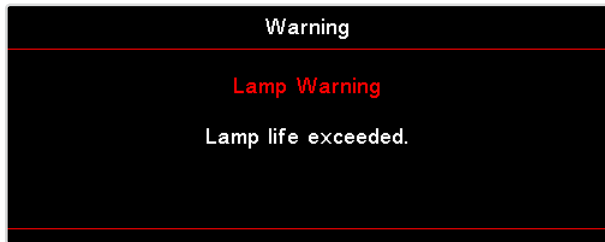

Warning:

Only use genuine lamps.

Remote Control

? If the remote control does not work

- ▶ Check the operating angle of the remote control is within $\pm 15^\circ$ both horizontally and vertically of one of the IR receivers on the projector.
- ▶ Make sure there are no any obstructions between the remote control and the projector. Move to within 7 m (23 ft) of the projector.
- ▶ Make sure batteries are inserted correctly.
- ▶ Replace batteries if they are exhausted.

Replacing the Lamp

The projector automatically detects the lamp life. When the lamp life is nearing the end of use, you will receive a warning message.

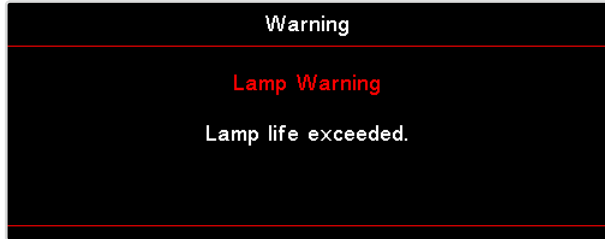

When you see this message, please contact your local reseller or service center to change the lamp as soon as possible. Make sure the projector has been cooled down for at least 30 minutes before changing the lamp.



Warning:

Lamp compartment is hot! Allow it to cool down before changing lamp!



Warning:

To reduce the risk of personal injury, do not drop the lamp module or touch the lamp bulb. The bulb may shatter and cause injury if it is dropped.

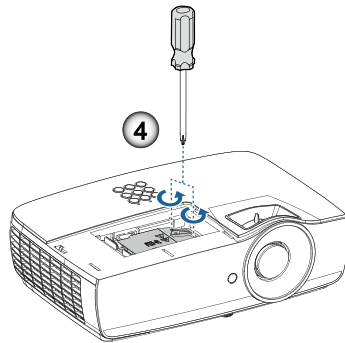
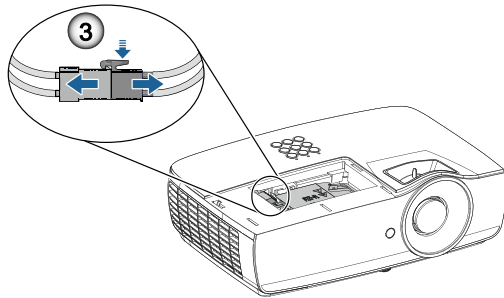
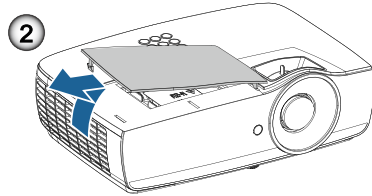
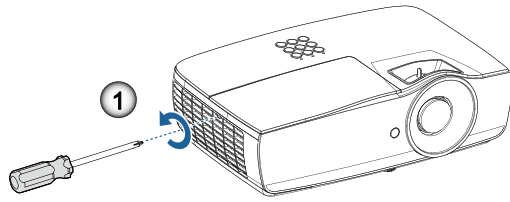

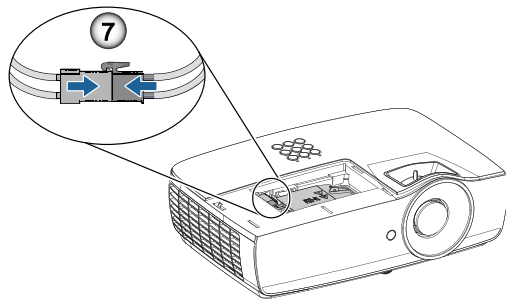
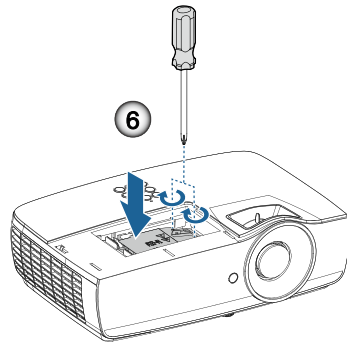
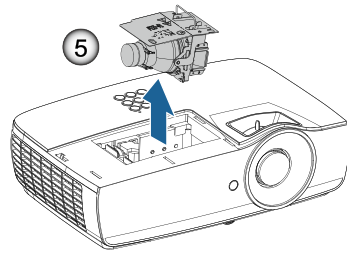

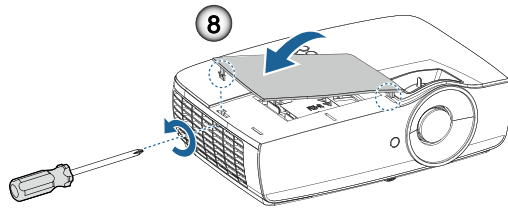

Lamp Replacing Procedure:

1. Switch off the power to the projector by pressing the Power button.
2. Allow the projector to cool down at least 30 minutes.
3. Disconnect the power cord.
4. Remove two screws on the lamp compartment cover. ❶
5. Remove the lamp compartment cover. ❷
6. Disconnect the lamp connector. ❸
7. Remove the two screws from the lamp module. Lift the module handle up. ❹
8. Pull firmly on the module handle to remove the lamp module. ❺

To replace the lamp module, reverse the previous steps. While installing, align the lamp module with the connector and ensure it is level to avoid damage.

9. Turn on the projector and do "Lamp Reset" after the lamp module is replaced.

Lamp Reset: (i) Press "Menu" -> (ii) Select "Setup" -> (iii) Select "Lamp Settings" -> (iv) Select "Lamp Reset" -> (v) Select "Yes".



Warning:

Lamp Connector must be installed flush with the connector base as shown in the image below. A gap between the Lamp Connector and the connector base will cause damage to the projector. The following images illustrate correct and incorrect Lamp Connector installations.

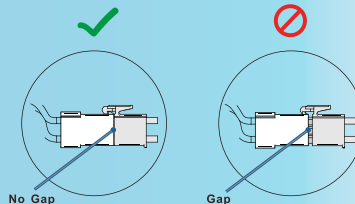

Compatible resolutions

Signal	Resolution	H-SYNC (KHz)	V-SYNC (Hz)	COMPONENT	VGA (Analog)	HDMI 1 HDMI 2/MHL (Digital)
VESA	720 x 400	31.5	70.1	—	○	○
	640 x 480	31.5	60	—	○	○
	640 x 480	35	66.667	—	○	○
	640 x 480	37.86	72.8	—	○	○
	640 x 480	37.5	75	—	○	○
	640 x 480	43.3	85	—	○	○
	640 x 480	61.9	119.5	—	○	○
	800 x 600	37.9	60.3	—	○	○
	800 x 600	46.9	75	—	○	○
	800 x 600	48.1	72.2	—	○	○
	800 x 600	53.7	85.1	—	○	○
VESA	800 x 600	76.3	120	—	○	○
	832 x 624	49.722	74.546	—	○	○
	1024 x 768	48.4	60	—	○	○
	1024 x 768	56.5	70.1	—	○	○
	1024 x 768	60.241	75.02	—	○	○
	1024 x 768	60	75	—	○	○
VESA	1024 x 768	68.7	85	—	○	○
	1024 x 768	97.6	120	—	○	○
	1152 x 864	68.68	75.06	—	○	○
	1280 x 720	45	60	—	○	○
	1280 x 720	90	120	—	○	○
	1280 x 768 (Reduce Blanking)	47.4	60	—	○	○
	1280 x 768	47.8	59.9	—	○	○
	1280 x 800	49.7	59.8	—	○	○
	1280 x 800	62.8	74.9	—	○	○
	1280 x 800	71.6	84.9	—	○	○
	1280 x 800	101.6	119.9	—	○	○
	1280 x 1024	64	60	—	○	○
	1280 x 1024	80	75	—	○	○
	1280 x 1024	91.1	85	—	○	○
	1280 x 960	60	60	—	○	○
	1280 x 960	85.9	85	—	○	○
	1366 x 768	47.7	60	—	○	○
	1400 x 1050	65.3	60	—	○	○
	1440 x 900	55.9	59.9	—	○	○
	1440 x 900	70.6	75	—	○	○
1600 x 1200	75	60	—	○	○	
1680 x 1050 (Reduce Blanking)	64.67	59.88	—	○	○	
1680 x 1050	65.29	59.95	—	○	○	
1920 x 1080	67.5	60	—	○	○	
1920 x 1200 (Reduce Blanking)	74.038	59.95	—	○	○	

Appendices

Signal	Resolution	H-SYNC (KHz)	V-SYNC (Hz)	COMPONENT	VGA (Analog)	HDMI 1 HDMI 2/MHL (Digital)
Apple Macintosh	640 x 480	35	66.7	—	○	○
	832 x 624	49.7	74.5	—	○	○
	1024 x 768	60.2	74.9	—	○	○
	1152 x 870	68.7	75.1	—	○	○
SDTV	480i	15.734	60	○	—	○
	576i	15.625	50	○	—	○
EDTV	576p	31.3	50	○	—	○
	480p	31.5	60	○	—	○
HDTV	720p	37.5	50	○	—	○
	720p	45	60	○	—	○
	1080i	33.8	60	○	—	○
	1080i	28.1	50	○	—	○
	1080p	27	24	○	—	○
	1080p	28	25	○	—	○
	1080p	33.7	30	○	—	○
	1080p	56.3	50	○	—	○
	1080p	67.5	60	○	—	○

True 3D Video Compatibility table

Input Resolutions		Input timing	
HDMI 1.4a 3D Input	1280 x 720p @50Hz	Top-and-Bottom	
	1280 x 720p @60Hz	Top-and-Bottom	
	1280 x 720p @50Hz	Frame packing	
	1280 x 720p @60Hz	Frame packing	
	1920 x 1080i @50Hz	Side-by-Side (Half)	
	1920 x 1080i @60Hz	Side-by-Side (Half)	
	1920 x 1080p @24Hz	Top-and-Bottom	
	1920 x 1080p @24Hz	Frame packing	
HDMI 1.3	1920 x 1080i @50Hz	Side-by-Side (Half)	SBS mode is on
	1920 x 1080i @60Hz		
	1280 x 720p @50Hz		
	1280 x 720p @60Hz	Top-and-Bottom	TAB mode is on
	1920 x 1080i @50Hz		
	1920 x 1080i @60Hz		
	1280 x 720p @50Hz		
	1280 x 720p @60Hz	HQFS	3D format is Frame sequential
480i			

- ▶ If 3D input is 1080p @24Hz, the DMD should replay with integral multiple with 3D mode.
- ▶ 1080i @25Hz and 720p @50Hz will run in 100Hz; other 3D timing will run in 120Hz.

RS232 Commands and Protocol Function List

RS232 Pin Assignments (projector side)

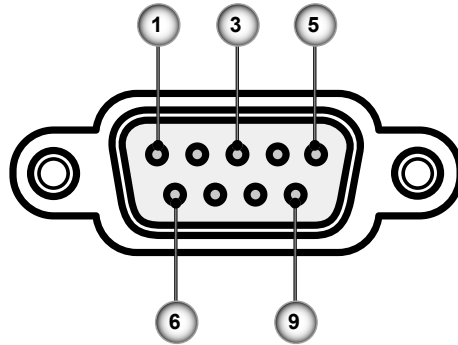

Pin no.	Name	I/O (From Projector Side)
1	NC	—
2	RXD	IN
3	TXD	OUT
4	NC	—
5	NC	—
6	NC	—
7	RS232	RTS
8	RS232	CTS
9	NC	—

RS232 Protocol Function List

RS232 ASCII Code	HEX Code	Function	Description
		System Auto Send	a=0 Standby Mode a=1 Warming up a=2 Cooling Down a=3 Out of Range a=4 Lamp Fail (LED Fail) a=5 Thermal Switch Error a=6 Fan Lock a=7 Over Temperature a=8 Lamp Hours Running Out a=9 Cover Open a=10 Lamp Ignite Fail a=11 Format Board Power On Fail a=12 Color Wheel Unexpected Stop a=13 // a=14 FAN 1 Lock a=15 FAN 2 Lock a=16 FAN 3 Lock a=17 FAN 4 Lock a=18 FAN 5 Lock a=19 LAN fail then restart a=20 LD lower than 60% a=21 LD NTC (1) Over Temperature a=22 LD NTC (2) Over Temperature a=23 High Ambient Temperature a=24 System Ready
~XX151 1	7E 30 30 31 35 31 20 31 0D	Model Name	*a=2 XGA a=3 WXGA a=4 1080p a=5 WUXGA*
~XX121 1	7E 30 30 31 32 31 20 31 0D	Input Source Commands	a = 0 None a = 2 VGA a = 7 HDMI1 a = 8 HDMI2 a = 13 Network Display a = 14 USB Display a = 17 Multimedia
~XX122 1	7E 30 30 31 32 32 20 31 0D	Software Version	dddd = Software Version
~XX123 1	7E 30 30 31 32 33 20 31 0D	Display Mode	a = 0 None a = 1 Presentation a = 2 Bright a = 3 Cinema a = 4 sRGB a = 5 User a = 7 Blackboard a = 9 3D a = 10 DICOM SIM. a = 12 BlackBoard

Appendices

RS232 ASCII Code	HEX Code	Function	Description
~XX124 1	7E 30 30 31 32 34 20 31 0D	Power State	a = 0 Off a = 1 On
~XX125 1	7E 30 30 31 32 35 20 31 0D	Brightness	aaa can be -50~ + 50
~XX126 1	7E 30 30 31 32 36 20 31 0D	Contrast	aaa can be -50~ + 50
~XX127 1	7E 30 30 31 32 37 20 31 0D	Format	aa=0 None aa=1 4:3 aa=2 16:9 aa=3 16:10 aa=5 LBX aa=6 Native aa=7 Auto
~XX128 1	7E 30 30 31 32 38 20 31 0D	Color Temperature	a=0 Standard a=1 Cool a=2 Cold a=3 Warm
~XX129 1	7E 30 30 31 32 39 20 31 0D	Projection Mode	a=0 Front-Desktop a=1 Rear-Desktop a=2 Front-Ceiling/ a=3 Rear-Ceiling
~XX353 1	7E 30 30 33 35 33 20 31 0D	Serial number	a= serial number string
~XX354 1	7E 30 30 33 35 34 20 31 0D	Closed Captioning	a = 0 Off a = 1 CC1 a = 2 CC2
~XX355 1	7E 30 30 33 35 35 20 31 0D	AV Mute	a = 0 Off a = 1 On
~XX356 1	7E 30 30 33 35 36 20 31 0D	Mute	a = 0 Off a = 1 On
~XX357 1	7E 30 30 33 35 37 20 31 0D	LAN FW version	eeeeee = Software Version
~XX358 1	7E 30 30 33 35 38 20 31 0D	Current Watt	aaaa=0000~9999
~XX150 1	7E 30 30 31 35 30 20 31 0D	Information 1	a = Power Status a=0 Power Off a=1 Power On b = Lamp Hour (LED Hours) bbbb Lamp Hour (LED Hours) c = Input Source cc=00 None cc=01 DVI cc=02 VGA1 cc=03 VGA2 cc=04 S-Video cc=05 Video cc=06 BNC cc=07 HDMI1 cc=08 HDMI2 cc=09 Wireless cc=10 Compent

Appendices

RS232 ASCII Code	HEX Code	Function	Description
			cc=11 Flash drive cc=12 Network Display (Presenter) cc=13 USB Display cc=14 HDMI3 cc=15 DisplayPort cc=16 HDBaseT d = Firmware Version dddd Firmware Version e = Display mode ee=00 None ee=01 Presentation ee=02 Bright ee=03 Cinema ee=04 sRGB\Reference\Standard ee=05 User(1) ee=06 User2 ee=07 Blackboard ee=08 Classroom ee=09 3D ee=10 DICOM SIM. ee=11 Film ee=12 Game ee=13 Cinema ee=14 Vivid ee=15 ISF Day ee=16 ISF Night ee=17 ISF 3D ee=18 Blending ee=21 HDR
~XX150 4	7E 30 30 31 35 30 20 34 0D	- Resolution	a = string (e.g. Ok1920x1080)
~XX150 5	7E 30 30 31 35 30 20 35 0D	- Signal Format	a = string
~XX150 16	7E 30 30 31 35 30 20 31 36 0D	Standby Power Mode	a=1 Active a=0 Eco.
~XX150 17	7E 30 30 31 35 30 20 31 37 0D	DHCP	a=1 On a=0 Off
~XX150 19	7E 30 30 31 35 30 20 31 39 0D	Refresh rate	a = string (Refresh rate e.g. Ok60Hz)
~XX87 1	7E 30 30 38 37 20 31 0D	LAN Settings / Network State	*a=0 Disconnected a=1 Connected*
~XX87 3	7E 30 30 38 37 20 33 0D	LAN Settings /IP Address	
~XX451 1	7E 30 30 34 35 31 20 31 0D	WLAN Settings / Network State	a=0 Disconnected a=1 Connected*
~XX451 2	7E 30 30 34 35 31 20 32 0D	WLAN Settings /IP Address	return IP
~XX451 3	7E 30 30 34 35 31 20 33 0D	WLAN Settings / SSID	return SSID
~XX555 1	7E 30 30 35 35 35 20 31 0D	LAN MAC Address	return SSID

Appendices

RS232 ASCII Code	HEX Code	Function	Description
~XX555 2	7E 30 30 35 35 35 20 32 0D	WLAN MAC Address	return SSID
~XX108 1	7E 30 30 31 30 38 20 31 0D	Lamp Hour Total	(5 digits) Total Lamp Hours
~XX108 3	7E 30 30 31 30 38 20 33 0D	Lamp Hour (Bright)	(5 digits) Total Lamp Hours
~XX108 4	7E 30 30 31 30 38 20 34 0D	Lamp Hour (Eco.)	(5 digits) Total Lamp Hours
~XX108 5	7E 30 30 31 30 38 20 35 0D	Lamp Hour (Dynamic)	(5 digits) Total Lamp Hours
~XX108 6	7E 30 30 31 30 38 20 36 0D	Lamp Hour (Eco+)	(5 digits) Total Lamp Hours
~XX543 1	7E 30 30 35 34 33 20 31 0D	H Image Shift	a=%
~XX543 2	7E 30 30 35 34 33 20 32 0D	V Image Shift	a=%
~XX543 3	7E 30 30 35 34 33 20 33 0D	V Keystone	a=%
~XX543 4	7E 30 30 35 34 33 20 34 0D	H Keystone	a=%
~XX544 1	7E 30 30 35 34 34 20 31 0D	Security Timer Month	a = 00-12
~XX544 2	7E 30 30 35 34 34 20 32 0D	Security Timer Day	a = 00-30
~XX544 3	7E 30 30 35 34 34 20 33 0D	Security Timer Hour	a = 00-24
~XX558 1	7E 30 30 35 35 38 20 31 0D	Projector ID	a=%
~XX00 1	7E 30 30 30 30 20 31 0D	Power On	
~XX00 0	7E 30 30 30 30 20 30 0D	Power Off	(0/2 for backward compatible)
~XX00 1 ~nnnn	7E 30 30 30 30 20 31 20 a 0D	Power On with Password	nnnn=password ~nnnn = ~0000 (a=7E 30 30 30 30) ~9999 (a=7E 39 39 39 39)
~XX01 1	7E 30 30 30 31 20 31 0D	Re-sync	
~XX02 1	7E 30 30 30 32 20 31 0D	AV Mute	On
~XX02 0	7E 30 30 30 32 20 30 0D	AV Mute	Off (0/2 for backward compatible)
~XX03 1	7E 30 30 30 33 20 31 0D	Mute	On
~XX03 0	7E 30 30 30 33 20 30 0D	Mute	Off (0/2 for backward compatible)
~XX04 1	7E 30 30 30 34 20 31 0D	Freeze	
~XX04 0	7E 30 30 30 34 20 30 0D	Unfreeze	66c (0/2 for backward compatible)
~XX140 10	7E 30 30 31 34 30 20 31 30 0D	Up	
~XX140 11	7E 30 30 31 34 30 20 31 31 0D	Left	
~XX140 12	7E 30 30 31 34 30 20 31 32 0D	Enter (for projection MENU)	

Appendices

RS232 ASCII Code	HEX Code	Function	Description
~XX140 13	7E 30 30 31 34 30 20 31 33 0D	Right	
~XX140 14	7E 30 30 31 34 30 20 31 34 0D	Down	
~XX140 15	7E 30 30 31 34 30 20 31 35 0D	V Keystone +	
~XX140 16	7E 30 30 31 34 30 20 31 36 0D	V Keystone -	
~XX140 17	7E 30 30 31 34 30 20 31 37 0D	Volume -	
~XX140 18	7E 30 30 31 34 30 20 31 38 0D	Volume +	
~XX140 19	7E 30 30 31 34 30 20 31 39 0D	Brightness	
~XX140 20	7E 30 30 31 34 30 20 32 30 0D	Menu	
~XX140 21	7E 30 30 31 34 30 20 32 31 0D	Zoom	
~XX140 28	7E 30 30 31 34 30 20 32 38 0D	Contrast	
~XX140 47	7E 30 30 31 34 30 20 34 37 0D	Source	
~XX06 1	7E 30 30 30 36 20 31 0D	Zoom Minus	
~XX313 1	7E 30 30 33 31 33 20 31 0D	Information menu	On
~XX313 0	7E 30 30 33 31 33 20 30 0D	Information menu	Off (0/2 for backward compatible)
~XX12 1	7E 30 30 31 32 20 31 0D	Input Source Direct Commands	HDMI 1
~XX12 5	7E 30 30 31 32 20 35 0D	Input Source Direct Commands	VGA
~XX12 15	7E 30 30 31 32 20 31 35 0D	Input Source Direct Commands	HDMI 2
~XX12 18	7E 30 30 31 32 20 31 38 0D	Input Source Direct Commands	Network Display(Presenter)
~XX12 19	7E 30 30 31 32 20 31 39 0D	Input Source Direct Commands	USB display
~XX12 23	7E 30 30 31 32 20 32 33 0D	Input Source Direct Commands	Multimedia
~XX20 1	7E 30 30 32 30 20 31 0D	Display Mode	Presentation
~XX20 2	7E 30 30 32 30 20 32 0D	Display Mode	Bright
~XX20 3	7E 30 30 32 30 20 33 0D	Display Mode	Cinema
~XX20 4	7E 30 30 32 30 20 34 0D	Display Mode	sRGB / Reference / Standard(Proscene)
~XX20 5	7E 30 30 32 30 20 35 0D	Display Mode	User/ User 1
~XX20 7	7E 30 30 32 30 20 37 0D	Display Mode	Blackboard
~XX20 9	7E 30 30 32 30 20 39 0D	Display Mode	3D
~XX20 13	7E 30 30 32 30 20 31 33 0D	Display Mode	DICOM SIM.

Appendices

RS232 ASCII Code	HEX Code	Function	Description
~XX21 n	7E 30 30 32 31 20 a 0D	Brightness	n = -50 (a=2D 35 30) ~ 50 (a=35 30)
~XX46 n	7E 30 30 34 36 20 a 0D	Brightness -	n=1
~XX46 n	7E 30 30 34 36 20 a 0D	Brightness +	n=2
~XX22 n	7E 30 30 32 32 20 a 0D	Contrast	n = -50 (a=2D 35 30) ~ 50 (a=35 30)
~XX47 n	7E 30 30 34 37 20 a 0D	Contrast -	n=1
~XX47 n	7E 30 30 34 37 20 a 0D	Contrast +	n=2
~XX23 n	7E 30 30 32 33 20 a 0D	Sharpness	n = 1 (a=31) ~ 15 (a=31 35)
~XX44 n	7E 30 30 34 34 20 a 0D	Tint	n = -50 (a=2D 35 30) ~ 50 (a=35 30)
~XX45 n	7E 30 30 34 35 20 a 0D	Color / Saturation	n = -50 (a=2D 35 30) ~ 50 (a=35 30)
~XX24 n	7E 30 30 32 34 20 a 0D	RGB Gain/Bias	Red Gain n = -50 (a=2D 35 30) ~ 50 (a=35 30)
~XX25 n	7E 30 30 32 35 20 a 0D	RGB Gain/Bias	Green Gain n = -50 (a=2D 35 30) ~ 50 (a=35 30)
~XX26 n	7E 30 30 32 36 20 a 0D	RGB Gain/Bias	Blue Gain n = -50 (a=2D 35 30) ~ 50 (a=35 30)
~XX27 n	7E 30 30 32 37 20 a 0D	RGB Gain/Bias	Red Bias n = -50 (a=2D 35 30) ~ 50 (a=35 30)
~XX28 n	7E 30 30 32 38 20 a 0D	RGB Gain/Bias	Green Bias n = -50 (a=2D 35 30) ~ 50 (a=35 30)
~XX29 n	7E 30 30 32 39 20 a 0D	RGB Gain/Bias	Blue Bias n = -50 (a=2D 35 30) ~ 50 (a=35 30)
~XX517 1	7E 30 30 35 31 37 20 31 0D	RGB Gain/Bias Reset	Reset
~XX333 n	7E 30 30 33 33 33 20 a 0D	CMS / Color Matching	Red Stutation / x offset n = -50 (a=2D 35 30) ~ 50 (a=35 30)
~XX327 n	7E 30 30 33 32 37 20 a 0D	CMS / Color Matching	Red Hue / y offset n = -50 (a=2D 35 30) ~ 50 (a=35 30)
~XX339 n	7E 30 30 33 33 39 20 a 0D	CMS / Color Matching	Red Gain /Brightness n = -50 (a=2D 35 30) ~ 50 (a=35 30)
~XX334 n	7E 30 30 33 33 34 20 a 0D	CMS / Color Matching	Green Stutation / x offset n = -50 (a=2D 35 30) ~ 50 (a=35 30)
~XX328 n	7E 30 30 33 32 38 20 a 0D	CMS / Color Matching	Green Hue / y offset n = -50 (a=2D 35 30) ~ 50 (a=35 30)
~XX340 n	7E 30 30 33 34 30 20 a 0D	CMS / Color Matching	Green Gain /Brightness n = -50 (a=2D 35 30) ~ 50 (a=35 30)
~XX335 n	7E 30 30 33 33 35 20 a 0D	CMS / Color Matching	Blue Stutation / x offset n = -50 (a=2D 35 30) ~ 50 (a=35 30)
~XX329 n	7E 30 30 33 32 39 20 a 0D	CMS / Color Matching	Blue Hue / y offset n = -50 (a=2D 35 30) ~ 50 (a=35 30)
~XX341 n	7E 30 30 33 34 31 20 a 0D	CMS / Color Matching	Blue Gain /Brightness n = -50 (a=2D 35 30) ~ 50 (a=35 30)
~XX336 n	7E 30 30 33 33 36 20 a 0D	CMS / Color Matching	Cyan Stutation / x offset n = -50 (a=2D 35 30) ~ 50 (a=35 30)
~XX330 n	7E 30 30 33 33 30 20 a 0D	CMS / Color Matching	Cyan Hue / y offset n = -50 (a=2D 35 30) ~ 50 (a=35 30)
~XX342 n	7E 30 30 33 34 32 20 a 0D	CMS / Color Matching	Cyan Gain /Brightness n = -50 (a=2D 35 30) ~ 50 (a=35 30)

Appendices

RS232 ASCII Code	HEX Code	Function	Description
~XX337 n	7E 30 30 33 33 37 20 a 0D	CMS / Color Matching	Yellow Stutation / x offset n = -50 (a=2D 35 30) ~ 50 (a=35 30)
~XX331 n	7E 30 30 33 33 31 20 a 0D	CMS / Color Matching	Yellow Hue / y offset n = -50 (a=2D 35 30) ~ 50 (a=35 30)
~XX343 n	7E 30 30 33 34 33 20 a 0D	CMS / Color Matching	Yellow Gain /Brightness n = -50 (a=2D 35 30) ~ 50 (a=35 30)
~XX338 n	7E 30 30 33 33 38 20 a 0D	CMS / Color Matching	Magenta Stutation / x offset n = -50 (a=2D 35 30) ~ 50 (a=35 30)
~XX332 n	7E 30 30 33 33 32 20 a 0D	CMS / Color Matching	Magenta Hue / y offset n = -50 (a=2D 35 30) ~ 50 (a=35 30)
~XX344 n	7E 30 30 33 34 34 20 a 0D	CMS / Color Matching	Magenta Gain /Brightness n = -50 (a=2D 35 30) ~ 50 (a=35 30)
~XX345 n	7E 30 30 33 34 35 20 a 0D	CMS / Color Matching	White /R n = -50 (a=2D 35 30) ~ 50 (a=35 30)
~XX346 n	7E 30 30 33 34 36 20 a 0D	CMS / Color Matching	White /G n = -50 (a=2D 35 30) ~ 50 (a=35 30)
~XX347 n	7E 30 30 33 34 37 20 a 0D	CMS / Color Matching	White /B n = -50 (a=2D 35 30) ~ 50 (a=35 30)
~XX34 n	7E 30 30 33 34 20 a 0D	BrilliantColor™	n = 1 (a=31) ~ 10 (a=31 30)
~XX35 1	7E 30 30 33 35 20 31 0D	Gamma /Film	Film
~XX35 2	7E 30 30 33 35 20 32 0D	Gamma /Video	Video
~XX35 3	7E 30 30 33 35 20 33 0D	Gamma /Graphics	Graphics
~XX35 4	7E 30 30 33 35 20 34 0D	Gamma / PC(Standard)	PC (Standard)
~XX35 5	7E 30 30 33 35 20 35 0D	Gamma	1.8
~XX35 6	7E 30 30 33 35 20 36 0D	Gamma	2
~XX35 12	7E 30 30 33 35 20 31 32 1D	Gamma	2.4
~XX36 4	7E 30 30 33 36 20 34 0D	Color Temp.	Warm (D55)
~XX36 1	7E 30 30 33 36 20 31 0D	Color Temp.	Standard (D65)
~XX36 2	7E 30 30 33 36 20 32 0D	Color Temp.	Cool (D75)
~XX36 3	7E 30 30 33 36 20 33 0D	Color Temp.	Cold (D83)
~XX37 1	7E 30 30 33 37 20 31 0D	Color Space	Auto
~XX37 2	7E 30 30 33 37 20 32 0D	Color Space	RGB \ RGB (0-255)*
~XX37 4	7E 30 30 33 37 20 34 0D	Color Space	RGB (16 - 235)*
~XX37 3	7E 30 30 33 37 20 33 0D	Color Space	YUV
~XX60 1	7E 30 30 36 30 20 31 0D	Format	4:3 (4:3-I)
~XX60 2	7E 30 30 36 30 20 32 0D	Format	16:9-I/16:9
~XX60 3	7E 30 30 36 30 20 33 0D	Format	16:9-II / 16:10 (WXGA)

Appendices

RS232 ASCII Code	HEX Code	Function	Description
~XX60 5	7E 30 30 36 30 20 35 0D	Format	LBX
~XX60 6	7E 30 30 36 30 20 36 0D	Format	Native
~XX60 7	7E 30 30 36 30 20 37 0D	Format	AUTO
~XX61 n	7E 30 30 36 31 20 a 0D	Edge mask	n = 0 (a=30) ~ 10 (a=31 30)
~XX62 n	7E 30 30 36 32 20 a 0D	Zoom Pan and Scan	n = -5 (a=2D 35) ~ 25 (a=32 35)
~XX63 n	7E 30 30 36 33 20 a 0D	H Image Shift	n = -100 (a=2D 31 30 30) ~ 100 (a=31 30 30)
~XX540 n	7E 30 30 35 34 30 20 a 0D	H Image Shift -	
~XX540 n	7E 30 30 35 34 30 20 a 0D	H Image Shift +	
~XX64 n	7E 30 30 36 34 20 a 0D	V Image Shift	n = -100 (a=2D 31 30 30) ~ 100 (a=31 30 30)
~XX541 n	7E 30 30 35 34 31 20 a 0D	V Image Shift -	
~XX541 n	7E 30 30 35 34 31 20 a 0D	V Image Shift +	
~XX65 n	7E 30 30 36 35 20 a 0D	H Keystone	n = -40 (a=2D 34 30) ~ 40 (a=34 30)
~XX66 n	7E 30 30 36 36 20 a 0D	V Keystone	n = -40 (a=2D 34 30) ~ 40 (a=34 30)
~XX59 1	7E 30 30 35 39 20 31 0D	Four corners	top-left (right+)
~XX59 2	7E 30 30 35 39 20 32 0D	Four corners	top-left (left+)
~XX59 3	7E 30 30 35 39 20 33 0D	Four corners	top-left (up +)
~XX59 4	7E 30 30 35 39 20 34 0D	Four corners	top-left (down +)
~XX59 5	7E 30 30 35 39 20 35 0D	Four corners	top right (right +)
~XX59 6	7E 30 30 35 39 20 36 0D	Four corners	top right (left +1)
~XX59 7	7E 30 30 35 39 20 37 0D	Four corners	top right (up +1)
~XX59 8	7E 30 30 35 39 20 38 0D	Four corners	top right (down +1)
~XX59 9	7E 30 30 35 39 20 39 0D	Four corners	Bottom-left (right+)
~XX59 10	7E 30 30 35 39 20 31 30 0D	Four corners	Bottom-left(left+)
~XX59 11	7E 30 30 35 39 20 31 31 0D	Four corners	Bottom-left(Up+)
~XX59 12	7E 30 30 35 39 20 31 32 0D	Four corners	Bottom-left(down+)
~XX59 13	7E 30 30 35 39 20 31 33 0D	Four corners	Bottom-right (right+)
~XX59 14	7E 30 30 35 39 20 31 34 0D	Four corners	Bottom-right(left+)
~XX59 15	7E 30 30 35 39 20 31 35 0D	Four corners	Bottom-right(Up+)

Appendices

RS232 ASCII Code	HEX Code	Function	Description
~XX59 16	7E 30 30 35 39 20 31 36 0D	Four corners	Bottom-right(down+)
~XX230 0	7E 30 30 32 33 30 20 30 0D	3D Mode	Off (0/2 for backward compatible)
~XX230 1	7E 30 30 32 33 30 20 31 0D	3D Mode	DLP-Link
~XX230 3	7E 30 30 32 33 30 20 33 0D	3D Mode	IR
~XX231 0	7E 30 30 32 33 31 20 30 0D	3D Sync. Invert	On
~XX231 1	7E 30 30 32 33 31 20 31 0D	3D Sync. Invert	Off
~XX400 0	7E 30 30 34 30 30 20 30 0D	3D->2D	3D
~XX400 1	7E 30 30 34 30 30 20 31 0D	3D->2D	L
~XX400 2	7E 30 30 34 30 30 20 32 0D	3D->2D	R
~XX405 0	7E 30 30 34 30 35 20 30 0D	3D Format	Auto
~XX405 1	7E 30 30 34 30 35 20 31 0D	3D Format	SBS
~XX405 2	7E 30 30 34 30 35 20 32 0D	3D Format	Top and Bottom
~XX405 3	7E 30 30 34 30 35 20 33 0D	3D Format	Frame Sequential
~XX405 8	7E 30 30 34 30 35 20 38 0D	3D Format	Off
~XX70 1	7E 30 30 37 30 20 31 0D	Language	English
~XX70 2	7E 30 30 37 30 20 32 0D	Language	German
~XX70 3	7E 30 30 37 30 20 33 0D	Language	French
~XX70 4	7E 30 30 37 30 20 34 0D	Language	Italian
~XX70 5	7E 30 30 37 30 20 35 0D	Language	Spanish
~XX70 6	7E 30 30 37 30 20 36 0D	Language	Portuguese
~XX70 7	7E 30 30 37 30 20 37 0D	Language	Polish
~XX70 8	7E 30 30 37 30 20 38 0D	Language	Dutch
~XX70 9	7E 30 30 37 30 20 39 0D	Language	Swedish
~XX70 10	7E 30 30 37 30 20 31 30 0D	Language	Norwegian/Danish
~XX70 11	7E 30 30 37 30 20 31 31 0D	Language	Finnish
~XX70 12	7E 30 30 37 30 20 31 32 0D	Language	Greek
~XX70 13	7E 30 30 37 30 20 31 33 0D	Language	Traditional Chinese
~XX70 14	7E 30 30 37 30 20 31 34 0D	Language	Simplified Chinese

Appendices

RS232 ASCII Code	HEX Code	Function	Description
~XX70 15	7E 30 30 37 30 20 31 35 0D	Language	Japanese
~XX70 16	7E 30 30 37 30 20 31 36 0D	Language	Korean
~XX70 17	7E 30 30 37 30 20 31 37 0D	Language	Russian
~XX70 18	7E 30 30 37 30 20 31 38 0D	Language	Hungarian
~XX70 19	7E 30 30 37 30 20 31 39 0D	Language	Czech
~XX70 20	7E 30 30 37 30 20 32 30 0D	Language	Arabic
~XX70 21	7E 30 30 37 30 20 32 31 0D	Language	Thai
~XX70 22	7E 30 30 37 30 20 32 32 0D	Language	Turkish
~XX70 23	7E 30 30 37 30 20 32 33 0D	Language	Farsi
~XX70 24	7E 30 30 37 30 20 32 34 0D	Language	Danish
~XX70 25	7E 30 30 37 30 20 32 35 0D	Language	Vietnamese
~XX70 26	7E 30 30 37 30 20 32 36 0D	Language	Indonesian
~XX70 27	7E 30 30 37 30 20 32 37 0D	Language	Romanian
~XX70 28	7E 30 30 37 30 20 32 38 0D	Language	Slovakian
~XX71 1	7E 30 30 37 31 20 31 0D	Projection	Front-Desktop
~XX71 2	7E 30 30 37 31 20 32 0D	Projection	Rear-Desktop
~XX71 3	7E 30 30 37 31 20 33 0D	Projection	Front-Ceiling
~XX71 4	7E 30 30 37 31 20 34 0D	Projection	Rear-Ceiling
~XX72 1	7E 30 30 37 32 20 31 0D	Menu Location	Top Left
~XX72 2	7E 30 30 37 32 20 32 0D	Menu Location	Top Right
~XX72 3	7E 30 30 37 32 20 33 0D	Menu Location	Centre
~XX72 4	7E 30 30 37 32 20 34 0D	Menu Location	Bottom Left
~XX72 5	7E 30 30 37 32 20 35 0D	Menu Location	Bottom Right
~XX90 1	7E 30 30 39 30 20 31 0D	Screen Type	16:10
~XX90 0	7E 30 30 39 30 20 30 0D	Screen Type	16:9
~XX91 1	7E 30 30 39 31 20 31 0D	Signal	Automatic On
~XX91 0	7E 30 30 39 31 20 30 0D	Signal	Automatic Off
~XX73 n	7E 30 30 37 33 20 a 0D	Signal	Frequency n = -5 (a=2D 35) ~ 5 (a=35) By signal

Appendices

RS232 ASCII Code	HEX Code	Function	Description
~XX74 n	7E 30 30 37 34 20 a 0D	Signal	Phase n = 0 (a=30) ~ 31 (a=33 31) By signal
~XX75 n	7E 30 30 37 35 20 a 0D	Signal	H. Position n = -5 (a=2D 35) ~ 5 (a=35) By timing
~XX76 n	7E 30 30 37 36 20 a 0D	Signal	V. Position n = -5 (a=2D 35) ~ 5 (a=35) By timing
~XX77 ~nnnnnn	7E 30 30 37 37 20 a 0D	Security Timer	a= mm/dd/hh mm= 00 (aa=30 30) ~ 12 (aa=31 32) dd = 00 (bb=30 30) ~ 30 (bb=33 30) hh= 00 (cc=30 30) ~ 24 (cc=32 34)
~XX537 n	7E 30 30 35 33 37 20 a 0D	Security Timer	Month n = 00 (a=30 30) ~ 12 (a=31 32)
~XX538 n	7E 30 30 35 33 38 20 a 0D	Security Timer	Day n = 00 (a=30 30) ~ 30 (a=33 30)
~XX539 n	7E 30 30 35 33 39 20 a 0D	Security Timer	Hour n = 00 (a=30 30) ~ 24 (a=32 34)
~XX79 n	7E 30 30 37 39 20 a 0D	Projector ID	n = 00 (a=30 30) ~ 99 (a=39 39)
~XX310 1	7E 30 30 33 31 30 20 31 0D	Internal Speaker	On
~XX310 0	7E 30 30 33 31 30 20 30 0D	Internal Speaker	Off (0/2 for backward compatible)
~XX80 1	7E 30 30 38 30 20 31 0D	Mute	On
~XX80 0	7E 30 30 38 30 20 30 0D	Mute	Off (0/2 for backward compatible)
~XX81 n	7E 30 30 38 31 20 a 0D	Volume (Audio)	n = 0 (a=30) ~ 10 (a=31 30)
~XX94 1	7E 30 30 39 34 20 31 0D	SRS	On
~XX82 1	7E 30 30 38 32 20 31 0D	Logo	Default
~XX82 2	7E 30 30 38 32 20 32 0D	Logo	User
~XX82 3	7E 30 30 38 32 20 33 0D	Logo	Neutral
~XX83 1	7E 30 30 38 33 20 31 0D	Logo Capture	
~XX85 1	7E 30 30 38 35 20 31 0D	Zoom / Focus	Lock
~XX85 2	7E 30 30 38 35 20 32 0D	Zoom / Focus	Unlock
~XX85 3	7E 30 30 38 35 20 33 0D	Zoom	Lock
~XX85 4	7E 30 30 38 35 20 34 0D	Zoom	Unlock
~XX85 5	7E 30 30 38 35 20 35 0D	Focus	Lock
~XX85 6	7E 30 30 38 35 20 36 0D	Focus	Unlock
~XX307 1	7E 30 30 33 30 37 20 31 0D	Zoom	Zoom +
~XX307 2	7E 30 30 33 30 37 20 32 0D	Zoom	Zoom -
~XX308 1	7E 30 30 33 30 38 20 31 0D	Focus	Fouc+

Appendices

RS232 ASCII Code	HEX Code	Function	Description
~XX308 2	7E 30 30 33 30 38 20 32 0D	Focus	Focus -
~XX450 1	7E 30 30 34 35 30 20 31 0D	WLAN Settings / WLAN	On
~XX450 0	7E 30 30 34 35 30 20 30 0D	WLAN Settings / WLAN	Off (0/2 for backward compatible)
~XX454 1	7E 30 30 34 35 34 20 31 0D	Crestron	On
~XX454 0	7E 30 30 34 35 34 20 30 0D	Crestron	Off
~XX455 1	7E 30 30 34 35 35 20 31 0D	Extron	On
~XX455 0	7E 30 30 34 35 35 20 30 0D	Extron	Off
~XX456 1	7E 30 30 34 35 36 20 31 0D	PJ Link	On
~XX456 0	7E 30 30 34 35 36 20 30 0D	PJ Link	Off
~XX457 1	7E 30 30 34 35 37 20 31 0D	AMX Device Discovery	On
~XX457 0	7E 30 30 34 35 37 20 30 0D	AMX Device Discovery	Off
~XX458 1	7E 30 30 34 35 38 20 31 0D	Telnet	On
~XX458 0	7E 30 30 34 35 38 20 30 0D	Telnet	Off
~XX459 1	7E 30 30 34 35 39 20 31 0D	HTTP	On
~XX459 0	7E 30 30 34 35 39 20 30 0D	HTTP	Off
~XX101 1	7E 30 30 31 30 31 20 31 0D	High Altitude	On
~XX101 0	7E 30 30 31 30 31 20 30 0D	High Altitude	Off (0/2 for backward compatible)
~XX102 1	7E 30 30 31 30 32 20 31 0D	Information Hide	On
~XX102 0	7E 30 30 31 30 32 20 30 0D	Information Hide	Off (0/2 for backward compatible)
~XX103 1	7E 30 30 31 30 33 20 31 0D	Keypad Lock	On
~XX103 0	7E 30 30 31 30 33 20 30 0D	Keypad Lock	Off (0/2 for backward compatible)
~XX348 1	7E 30 30 33 34 38 20 31 0D	Display Mode Lock	On
~XX348 0	7E 30 30 33 34 38 20 30 0D	Display Mode Lock	Off
~XX195 0	7E 30 30 31 39 35 20 30 0D	Test Pattern	None
~XX195 1	7E 30 30 31 39 35 20 31 0D	Test Pattern	Grid (White)
~XX195 2	7E 30 30 31 39 35 20 32 0D	Test Pattern	White
~XX11 0	7E 30 30 31 31 20 30 0D	IR Function	Off
~XX11 1	7E 30 30 31 31 20 31 0D	IR Function	On

Appendices

RS232 ASCII Code	HEX Code	Function	Description
~XX104 0	7E 30 30 31 30 34 20 30 0D	Background Color	None
~XX104 1	7E 30 30 31 30 34 20 31 0D	Background Color	Blue
~XX104 2	7E 30 30 31 30 34 20 32 0D	Background Color	Black
~XX104 3	7E 30 30 31 30 34 20 33 0D	Background Color	Red
~XX104 4	7E 30 30 31 30 34 20 34 0D	Background Color	Green
~XX104 5	7E 30 30 31 30 34 20 35 0D	Background Color	White
~XX104 6	7E 30 30 31 30 34 20 36 0D	Background Color	Gray
~XX104 7	7E 30 30 31 30 34 20 37 0D	Background Color	Logo
~XX350 n	7E 30 30 33 35 30 20 a 0D	Remote Code	n = 00 (a=30 30) ~ 99 (a=39 39)
~XX105 1	7E 30 30 31 30 35 20 31 0D	Direct Power On	On
~XX105 0	7E 30 30 31 30 35 20 30 0D	Direct Power On	Off (0/2 for backward compatible)
~XX113 1	7E 30 30 31 31 33 20 31 0D	Signal Power On	On
~XX113 0	7E 30 30 31 31 33 20 30 0D	Signal Power On	Off (0/2 for backward compatible)
~XX107 n	7E 30 30 31 30 37 20 a 0D	Sleep Timer (min)	n = 0 (a=30) ~ 180 (a=31 38 30) (30 minutes for each step).
~XX507 0	7E 30 30 35 30 37 20 30 0D	Sleep Timer Repeat	Off (0/2 for backward compatible)
~XX507 1	7E 30 30 35 30 37 20 31 0D	Sleep Timer Repeat	On
~XX115 1	7E 30 30 31 31 35 20 31 0D	Quick Resume	On
~XX115 0	7E 30 30 31 31 35 20 30 0D	Quick Resume	Off (0/2 for backward compatible)
~XX114 1	7E 30 30 31 31 34 20 31 0D	Power Mode (Standby)	Active
~XX114 0	7E 30 30 31 31 34 20 30 0D	Power Mode (Standby)	Eco. (<0.5W)
~XX109 1	7E 30 30 31 30 39 20 31 0D	Lamp Reminder	On
~XX109 0	7E 30 30 31 30 39 20 30 0D	Lamp Reminder	Off (0/2 for backward compatible)
~XX110 1	7E 30 30 31 31 30 20 31 0D	Brightness Mode	Bright
~XX110 2	7E 30 30 31 31 30 20 32 0D	Brightness Mode	Eco.
~XX110 3	7E 30 30 31 31 30 20 33 0D	Brightness Mode	Eco+
~XX110 4	7E 30 30 31 31 30 20 34 0D	Brightness Mode	Dynamic
~XX112 1	7E 30 30 31 31 32 20 31 0D	Reset (Reset to Default)	
~XX112 ~nnnn	7E 30 30 31 31 32 20 a 0D	Reset (Reset to Default) with password	~nnnn = ~0000 (a=7E 30 30 30 30) ~9999 (a=7E 39 39 39 39)

Appendices

RS232 ASCII Code	HEX Code	Function	Description
~XX506 0	7E 30 30 35 30 36 20 30 0D	Wall Color	Off
~XX506 7	7E 30 30 35 30 36 20 37 0D	Wall Color	Light Yellow
~XX506 3	7E 30 30 35 30 36 20 33 0D	Wall Color	Light Green
~XX506 4	7E 30 30 35 30 36 20 34 0D	Wall Color	Light Blue
~XX506 5	7E 30 30 35 30 36 20 35 0D	Wall Color	Pink
~XX506 6	7E 30 30 35 30 36 20 36 0D	Wall Color	Gray
~XX510 0	7E 30 30 35 31 30 20 30 0D	Audio Out	Off
~XX510 1	7E 30 30 35 31 30 20 31 0D	Audio Out	On
~XX511 0	7E 30 30 35 31 31 20 30 0D	HDMI Link	Off
~XX511 1	7E 30 30 35 31 31 20 31 0D	HDMI Link	On
~XX512 0	7E 30 30 35 31 32 20 30 0D	Inclusive of TV	No
~XX512 1	7E 30 30 35 31 32 20 31 0D	Inclusive of TV	Yes
~XX513 1	7E 30 30 35 31 33 20 31 0D	Power On Link	Mutual
~XX513 2	7E 30 30 35 31 33 20 32 0D	Power On Link	PJ --> Device
~XX513 3	7E 30 30 35 31 33 20 33 0D	Power On Link	Device --> PJ
~XX514 0	7E 30 30 35 31 34 20 30 0D	Power Off Link	Off
~XX514 1	7E 30 30 35 31 34 20 31 0D	Power Off Link	On
~XX515 0	7E 30 30 35 31 35 20 30 0D	Menu Timer	Off
~XX515 1	7E 30 30 35 31 35 20 31 0D	Menu Timer	5sec
~XX515 3	7E 30 30 35 31 35 20 33 0D	Menu Timer	10sec
~XX526 n	7E 30 30 35 32 36 20 a 0D	Menu Transparency	n = 0 (a=30) ~ 9 (a=39)
~XX516 1	7E 30 30 35 31 36 20 31 0D	Four corners reset	Reset
~XX518 1 ~nnnnnnnnnn	7E 30 30 35 31 38 20 31 20 a 0D	Input Name	HDMI1 (a= 7E +nnnnnnnnnn)
~XX518 6 ~nnnnnnnnnn	7E 30 30 35 31 38 20 36 20 a 0D	Input Name	HDMI2/MHL (a= 7E +nnnnnnnnnn)
~XX518 8 ~nnnnnnnnnn	7E 30 30 35 31 38 20 38 20 a 0D	Input Name	VGA (a= 7E +nnnnnnnnnn)
~XX518 19 ~nnnnnnnnnn	7E 30 30 35 31 38 20 31 39 20 a 0D	Input Name	Network Display (a= 7E +nnnnnnnnnn)
~XX518 20 ~nnnnnnnnnn	7E 30 30 35 31 38 20 32 30 20 a 0D	Input Name	USB Display (a= 7E +nnnnnnnnnn)
~XX518 21 ~nnnnnnnnnn	7E 30 30 35 31 38 20 32 31 20 a 0D	Input Name	Multimedia (a= 7E +nnnnnnnnnn)

Telnet Commands

- ▶ Port: support 3 ports of 23/1023/2023
- ▶ Multi-connections: Projector could receive commands from different ports at the same time
- ▶ Command Format: Follow RS232 command format (support both of ASCII and HEX)
- ▶ Command Response: Follow RS232 return message.

Lead Code	Projector ID		Command ID			Space	Variable	Carriage Return
~	x	x	x	x	x		n	CR
Fix code One Digit~	00		Defined by Optoma 2 or 3 Digit. See the Follow content			One Digit	Per item Definition	Fix code One Digit



- For wide screen resolution (WXGA), the compatibility support is dependent on Notebook/PC models.

AMX Device Discovery Commands

- ▶ DP : 239.255.250.250
- ▶ Port No. : 9131
- ▶ Each UDP broadcast information as below are updated around 40 seconds

Command	Description	Remark (Parameter)
Device-UUID	MAC address (Hex value without ' :' separator)	12 digits
Device-SKDCClass	The Duet DeviceSdk class name	VideoProjector
Device-Make	Maker name	MakerPXLW
Device-Model	Model name	Projector

Command	Description	Remark (Parameter)
Config-URL	Device's IP address LAN IP address is shown up if LAN IP address is valid. Wireless LAN IP address is shown up if Wireless LAN IP address is valid.	http://xxx.xxx.xxx.xxx/index.html
Revision	The revision must follow a major.minor.micro scheme. The revision is only increased if the command protocol is modified.	1.0.0



- For wide screen resolution (WXGA), the compatibility support is dependent on Notebook/PC models.
- This AMX function is only to support AMX Device Discovery.
- The broadcast information only send out through valid interface.
- Both LAN and Wireless LAN interfaces could be supported at the same time.
- If "Beacon Validator" was used. Please take care below information.

PJLink™ Supported Commands

The table below shows commands to control the projector using the PJLink™ protocol.

Command Description Remark (Parameter)

Command	Description	Remark (Parameter)
POWR	Power control	0 = Standby
		1 = Power on
POWR?	Inquiry about the power state	0 = Standby
		1 = Power on
		2 = Cooling down
		3 = Warming up
INPT	INPT Input switching	11 = VGA1

Appendices



This projector is fully compliant to the specifications of JBMIA PJLink™ Class 1. It supports all the commands defined by PJLink™ Class 1, and the compliance has been verified with the PJLink™ standard specifications Version 1.0.

Command	Description	Remark (Parameter)
INPT?	Inquiry about input switching	12 = VGA2
		13 = Component
		14 = BNC
		21 = VIDEO
		22 = S-VIDEO
		31 = HDMI 1
		32 = HDMI 2
AVMT	Mute control	30 = Video and audio mute disable
AVMT?	Inquiry about the mute state	31 = Video and audio mute enable
ERST?	Inquiry about the error state	1st byte: Fan error, 0 or 2
		2nd byte: Lamp error, 0 to 2
		3rd byte: Temperature error, 0 or 2
		4th byte: Cover open error, 0 or 2
		5th byte: Filter error, 0 or 2
		6th byte: Other error, 0 or 2
		0 to 2 mean as follows: 0 = No error detected, 1 = Warning, 2 = Error
LAMP?	Inquiry about the lamp state	1st value (1 to 5 digits): Cumulative LAMP operating time (This item shows a lamp operating time (hour) calculated based on that LAMP MODE is LOW.)
		2nd value: 0 = Lamp off, 1 = Lamp on
INST?	Inquiry about the available inputs	The following value is returned. "11 12 21 22 31 32"
NAME?	Inquiry about the projector name	The projector name set on the NETWORK menu or the ProjectorView Setup window is returned
INF1?	Inquiry about the manufacturer name	"Optoma" is returned.
INF2?	Inquiry about the model name	"EH7700" is returned.
INF0?	Inquiry about other information	No other information is available. No parameter is returned.
CLSS?	Inquiry about the class information	"1" is returned.

Trademarks

- ▶ DLP is trademarks of Texas Instruments.
- ▶ IBM is a trademark or registered trademark of International Business Machines Corporation.
- ▶ Macintosh, Mac OS X, iMac, and PowerBook are trademarks of Apple Inc., registered in the U.S. and other countries.
- ▶ Microsoft, Windows, Windows Vista, Internet Explorer and PowerPoint are either a registered trademark or trademark of Microsoft Corporation in the United States and/or other countries.
- ▶ HDMI, the HDMI Logo and High-Definition Multimedia Interface are trademarks or registered trademarks of HDMI Licensing LLC.
- ▶ AMX Device Discovery

The projector is monitored and controlled by the control system of AMX.

- ▶ Crestron RoomView Connected™

The projector is monitored and controlled by the control system and software of Crestron Electronics, Inc.

- ▶ PJLink™

PJLink trademark is a trademark applied for registration or is already registered in Japan, the United States of America and other countries and areas.

This projector supports standard protocol PJLink™ for projector control and you can control and monitor projector's operations using the same application among projectors of different models and different manufacturers.

- ▶ Other product and company names mentioned in this user's manual may be the trademarks or registered trademarks of their respective holders.

- ▶ About Crestron RoomView Connected™

Electronics, Inc. to facilitate configuration of the control system of Crestron and its target devices.

For details, see the website of Crestron Electronics, Inc.

URL <http://www.crestron.com>

URL <http://www.crestron.com/getroomview/>

Ceiling Mount Installation

1. To prevent damage to your projector, please use the Optoma ceiling mount.
2. If you wish to use a third party ceiling mount kit, please ensure the screws used to attached a mount to the projector met the following specifications:
 - ▶ Screw type: M4
 - ▶ Maximum screw length: 11mm
 - ▶ Minimum screw length: 9mm



Please note that damage resulting from incorrect installation will invalidate the warranty.



Warning:

1. If you buy ceiling mount from other company, please be sure to use the correct screw size. Screw size will be different on different mounts. It depends on the plate thickness.
2. Be sure to keep at least 10cm gap between the ceiling and the bottom of the projector.
3. Avoid installing the projector near a heat source.

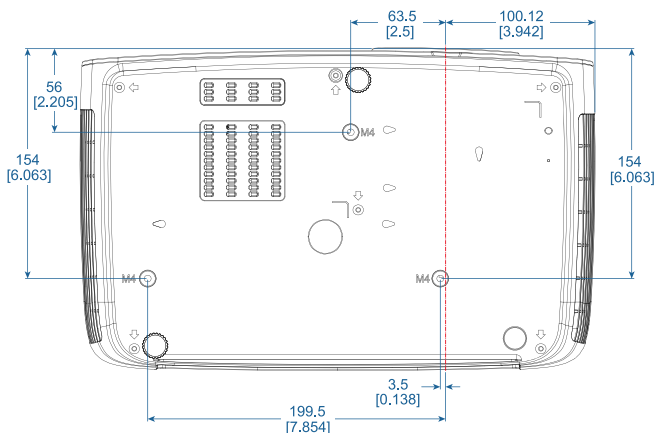
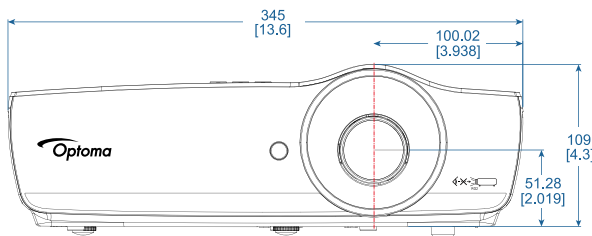

Optoma Global Offices

For service or support please contact your local office.

USA

3178 Laurelview Ct.,
Fremont, CA 94538, USA
www.optomausa.com

Tel : 888-289-6786
Fax : 510-897-8601
Service : services@optoma.com

Canada

3178 Laurelview Ct.,
Fremont, CA 94538, USA
www.optoma.ca

Tel : 888-289-6786
Fax : 510-897-8601
Service : services@optoma.com

Latin America

3178 Laurelview Ct.
Fremont, CA 94538, USA
www.optoma.com.br

Tel : 888-289-6786
Fax: 510-897-8601
www.optoma.com.mx

Europe

Unit 1, Network 41, Bourne End Mills
Hemel Hempstead, Herts, HP1 2UJ
United Kingdom
www.optoma.eu
Service Tel : +44 (0)1923 691865

Tel : +44 (0) 1923 691 800
Fax : +44 (0) 1923 691 888
Service : service@tsc-europe.com

Benelux BV

Randstad 22-123
1316 BW Almere
The Netherlands
www.optoma.nl

Tel : +31 (0) 36 820 0252
Fax : +31 (0) 36 548 9052

France

Bâtiment E
81-83 avenue Edouard Vaillant
92100 Boulogne Billancourt, France

Tel : +33 1 41 46 12 20
Fax : +33 1 41 46 94 35
Service : savoptoma@optoma.fr

Spain

C/ José Hierro,36 Of. 1C
28522 Rivas VaciaMadrid,
Spain

Tel : +34 91 499 06 06
Fax : +34 91 670 08 32

Appendices

Deutschland

Wiesenstrasse 21 W
D40549 Düsseldorf,
Germany

Tel : +49 (0) 211 506 6670
Fax : +49 (0) 211 506 66799
Service : info@optoma.de

Scandinavia

Lerpeveien 25
3040 Drammen
Norway
PO.BOX 9515
3038 Drammen
Norway

Tel : +47 32 98 89 90
FAX : +47 32 98 89 99
Service : info@optoma.no

Taiwan

12F., No.213, Sec. 3, Beixin Rd.,
Xindian Dist., New Taipei City 231,
Taiwan, R.O.C.
www.optoma.com.tw

TEL:+886-2-8911-8600
FAX: +886-2-8911-6550
Service : services@optoma.com.tw
asia.optoma.com

Hong Kong

Unit A, 27/F Dragon Centre, 79 Wing Hong Street,
Cheung Sha Wan Kowloon, Hong Kong
Tel : +852-2396-8968
www.optoma.com.hk

Fax: +852-2370-1222

China

5F, No. 1205, Kaixuan Rd.,
Changning District
Shanghai, 200052, China

TEL:+86-21-62947376
FAX:+86-21-62947375
www.optoma.com.cn

Japan

東京都足立区綾瀬 3-25-18
株式会社オーエス

コンタクトセンター:0120-380-495
Service : info@os-worldwide.com
<http://www.os-worldwide.com/>

Korea

WOOMI TECH.CO.,LTD.
4F, Minu Bldg.33-14, Kangnam-Ku,
seoul,135-815, KOREA

Tel : +82+2+34430004
Fax: +82+2+34430005

Regulation & Safety Notices

This appendix lists the general notices of your Projector.

FCC notice

This device has been tested and found to comply with the limits for a Class B digital device pursuant to Part 15 of the FCC rules. These limits are designed to provide reasonable protection against harmful interference in a residential installation. This device generates, uses and can radiate radio frequency energy and, if not installed and used in accordance with the instructions, may cause harmful interference to radio communications.

However, there is no guarantee that interference will not occur in a particular installation. If this device does cause harmful interference to radio or television reception, which can be determined by turning the device off and on, the user is encouraged to try to correct the interference by one or more of the following measures:

- ■ Reorient or relocate the receiving antenna.
- ■ Increase the separation between the device and receiver.
- ■ Connect the device into an outlet on a circuit different from that to which the receiver is connected.
- ■ Consult the dealer or an experienced radio/television technician for help.

Notice: Shielded cables

All connections to other computing devices must be made using shielded cables to maintain compliance with FCC regulations.

Caution

Changes or modifications not expressly approved by the manufacturer could void the user's authority, which is granted by the Federal Communications Commission, to operate this projector.

Operation conditions

This device complies with Part 15 of the FCC Rules. Operation is subject to the following two conditions:

1. This device may not cause harmful interference and
2. This device must accept any interference received, including interference that may cause undesired operation.

Notice: Canadian users

This Class B digital apparatus complies with Canadian ICES-003.

Remarque à l'intention des utilisateurs canadiens

Cet appareil numérique de la classe B est conforme à la norme NMB-003 du Canada.

Declaration of Conformity for EU countries

- EMC Directive 2014/30/EU (including amendments)
- Low Voltage Directive 2014/35/EU
- R & TTE Directive 1999/5/EC
(if product has RF function)
- RoHS Directive 2011/65/EU
- Energy Related Products (ErP) Directive 2009/125/EC

Disposal instructions



Do not throw this electronic device into the trash when discarding. To minimize pollution and ensure utmost protection of the global environment, please recycle it.