

**Canon**

MULTIMEDIA PROJECTOR

**LV-WX320/LV-X320/LV-WX310ST/LV-X310ST**

**User's Manual**

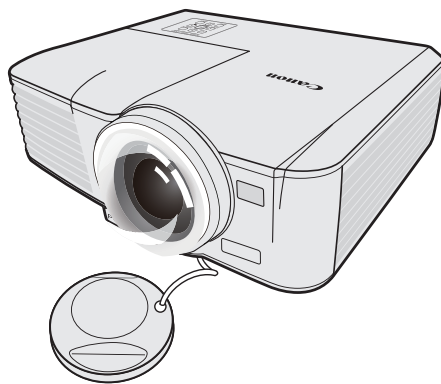
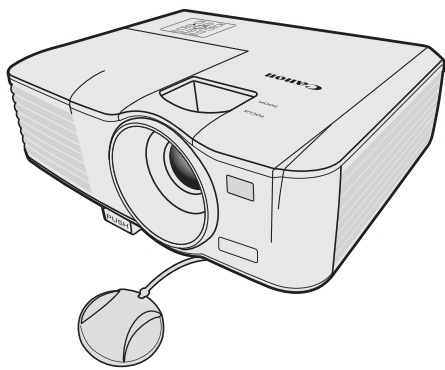

**ProSelecta**

View :: Compare :: Select - [www.ProSelecta.com](http://www.ProSelecta.com)

# *Table of Contents*

---

<b>Table of Contents</b> .....	<b>2</b>	<b>Configuring the LAN Settings</b> .....	<b>48</b>
<b>Safety instructions</b> .....	<b>3</b>	Controlling the projector remotely through a web browser (e-Control™) .....	49
<b>Contents of package</b> .....	<b>13</b>	Controlling the projector using PJLink™ application .....	51
<b>Projector exterior view</b> .....	<b>14</b>	<b>Menu operation</b> .....	<b>54</b>
<b>Controls and functions</b> .....	<b>15</b>	<b>Maintenance</b> .....	<b>61</b>
<b>Positioning your projector</b> .....	<b>19</b>	Care of the projector .....	61
Choosing a location .....	19	<b>Lamp information</b> .....	<b>62</b>
Obtaining a preferred projected image size .....	20	<b>Indicators</b> .....	<b>67</b>
<b>Connection</b> .....	<b>24</b>	<b>Troubleshooting</b> .....	<b>68</b>
Connecting a computer or monitor ..	24	<b>Specifications</b> .....	<b>69</b>
Connecting Video source devices ...	25	Projector specifications .....	69
<b>Operation</b> .....	<b>30</b>	Dimensions .....	71
Starting up the projector .....	30	Timing chart .....	72
Using the menus .....	31	Control Commands .....	76
Utilizing the password function .....	32	System Requirement .....	76
Switching input signal .....	34		
<b>Adjusting the projected image</b> ....	<b>35</b>		
Magnifying and searching for details .....	37		
Selecting the aspect ratio .....	37		
<b>Useful functions available during a presentation</b> .....	<b>39</b>		
Setting the presentation timer .....	42		
Hiding the image .....	43		
Locking control keys .....	43		
Freezing the image .....	43		
Adjusting the sound .....	44		
Personalizing the projector menu dis- play .....	44		
Shutting down the projector .....	44		
Direct power off .....	45		
<b>Watching 3D content</b> .....	<b>46</b>		
<b>Supervising and controlling by computer</b> .....	<b>48</b>		





# Safety instructions

Before installing and operating the projector, read this manual thoroughly.

This projector provides many convenient features and functions. Operating the projector properly enables you to manage those features and maintain it in good condition for many years to come.

Improper operation may result in not only shortening the product life, but also malfunctions, fire hazards, or other accidents.

If your projector does not seem to be operating properly, read this manual again, check operations and cable connections, and try the solutions in the “Troubleshooting” section in the user’s manual. If the problem still persists, contact the Canon Customer Support Center.

	<b>CAUTION</b> <b>RISK OF ELECTRIC SHOCK</b> <b>DO NOT OPEN</b>	
<b>CAUTION: TO REDUCE THE RISK OF ELECTRIC SHOCK, DO NOT REMOVE COVER (OR BACK). REFER SERVICING TO QUALIFIED SERVICE PERSONNEL.</b>		
	THIS SYMBOL INDICATES THAT DANGEROUS VOLTAGE CONSTITUTING A RISK OF ELECTRIC SHOCK IS PRESENT WITHIN THIS UNIT.	
	THIS SYMBOL INDICATES THAT THERE ARE IMPORTANT OPERATING AND MAINTENANCE INSTRUCTIONS FOR THIS UNIT IN THE USER’S MANUAL.	

<b>CAUTION</b> Not for use in a computer room as defined in the Standard for the Protection of Electronic Computer / Data Processing Equipment, ANSI / NFPA 75.
--------------------------------------------------------------------------------------------------------------------------------------------------------------------

<b>Copyright notice</b> Please note that enlarging or reducing the size of an image for commercial purposes or public presentation may infringe on the legally protected copyright or the copyright holder of the original material
<b>About Trademarks</b> <ul style="list-style-type: none"><li>• Ethernet is a registered trademark of Xerox Corporation.</li><li>• Microsoft, Windows, Windows XP, Windows Vista, Windows 7, Windows 8 and Aero are registered trademarks or trademarks of Microsoft Corporation in the United States and / or other countries.</li><li>• Mac, Mac OS and Macintosh are trademarks of Apple Inc., registered in the United States and / or other countries.</li><li>• HDMI, the HDMI logo and High-Definition Multimedia Interface are trademarks or registered trademarks of HDMI Licensing, LLC.</li><li>• PjLink is a registered trademark, or an application has been submitted for trademark, in Japan, the United States and / or other countries or regions.</li><li>• Crestron<sup>®</sup>, Crestron RoomView<sup>®</sup>, and Crestron Connected<sup>™</sup> are registered trademarks of Crestron Electronics, Inc.</li><li>• MHL, the MHL logo, and Mobile High-Definition Link are trademarks or registered trademarks of MHL, LLC in the United States and other countries.</li></ul>

---

## Safety Precautions

### WARNING:

- **THIS APPARATUS MUST BE GROUNDED.**
- **TO REDUCE THE RISK OF FIRE OR ELECTRIC SHOCK, DO NOT EXPOSE THIS APPLIANCE TO RAIN OR MOISTURE.**
- This projector produces intense light from the projection lens. Do not stare directly into the lens, otherwise eye damage could result. Be especially careful that children do not stare directly into the beam.
- Install the projector in a proper position. Otherwise it may result in a fire hazard.
- Allowing the proper amount of space on the top, sides, and rear of the projector cabinet is critical for proper air circulation and cooling of the unit. The diagram shown here indicates the minimum space required. If the projector is to be built into a compartment or similarly enclosed, these minimum distances must be maintained.

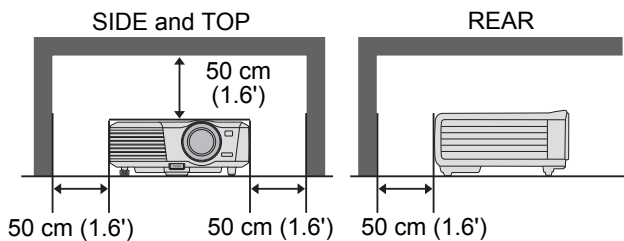

\*Unless otherwise noted, figures in this manual show the LV-WX320/LV-X320.

- Do not cover the ventilation slots on the projector. Heat build-up can reduce the service life of your projector, and can also be dangerous.
- If the projector is unused for an extended time, unplug the projector from the power outlet.
- Do not project the same image for a long time.

An afterimage may remain on the DMD panel due to the characteristics of the panel of the projector.

## CAUTION ON HANGING FROM THE CEILING

When hanging the projector from the ceiling, clean the air intake vents and top of the projector periodically with a vacuum cleaner. If you leave the projector unclean for a long time, the cooling fans can be clogged with dust, and it may cause a breakdown or a disaster.

**DO NOT SET THE PROJECTOR IN GREASY, WET, OR SMOKY CONDITIONS SUCH AS IN A KITCHEN TO PREVENT A BREAKDOWN OR A DISASTER. IF THE PROJECTOR COMES IN CONTACT WITH OIL OR CHEMICALS, IT MAY BECOME DETERIORATED.**

### ■ READ AND KEEP THIS MANUAL FOR LATER USE.

All the safety and operating instructions should be read before beginning to operate the product.

Read all of the instructions given here and retain them for later use. Unplug this projector from the AC power supply before cleaning. Do not use liquid or aerosol cleaners on the projector. Use a damp cloth for cleaning.

Follow all warnings and instructions marked on the projector.

For added protection of the projector during a lightning storm, or when it is left unattended or unused for long periods of time, unplug it from the wall outlet. This will prevent damage due to lightning and power surges.

---

Do not expose this unit to rain or use near water. For example, in a wet basement, near a swimming pool..., etc.

---

Do not use attachments not recommended by the manufacturer as they may result in hazards.

Do not place this projector on an unstable cart, stand, or table. The projector may fall, causing serious injury to a child or adult, and serious damage to the projector. Use only with a cart or stand recommended by the manufacturer, or sold with the projector. For wall or shelf mounting, use a tool such as a mounting kit to secure the projector.

An appliance and cart combination should be moved with care.

Sudden stops, excessive force, and uneven surfaces may cause the appliance and cart combination to overturn.



Slots and openings in the rear and front of the cabinet are provided for ventilation, to insure reliable operation of the equipment and to protect it from overheating.

The openings should never be covered with cloth or other materials, and the bottom opening should not be blocked by placing the projector on a bed, sofa, rug, or other similar surface. This projector should never be placed near or over a radiator or heat register.

This projector should not be placed in a built-in installation such as a book case unless proper ventilation is provided.

Never push objects of any kind into this projector through cabinet slots as they may touch dangerous voltage points or short out parts that could result in a fire or electric shock. Never spill liquid of any kind onto the projector.

Do not install the projector near the ventilation duct of air-conditioning equipment.

This projector should be operated using only the type of power source indicated on the marking label. If you are not sure of the type of power supplied, contact the Canon Customer Support Center or local power company.

Do not overload wall outlets and extension cords as this can result in fire or electric shock. Do not allow anything to rest on the power cord. Do not locate this projector where the cord may be damaged by people walking on it.

Do not attempt to service this projector yourself as opening or removing covers may expose you to dangerous voltages or other hazards. Refer all servicing to qualified service personnel.

Unplug this projector from the wall outlet and refer servicing to qualified service personnel under the following conditions:

- a When the power cord or plug is damaged or frayed.
- b If liquid has been spilled into the projector.
- c If the projector has been exposed to rain or water.
- d If the projector does not operate normally after following the operating instructions. Adjust only those controls that are covered in the operating instructions as improper adjustment of other controls may result in damage and will often require extensive work by a qualified technician to restore the projector to normal operating condition.
- e If the projector has been dropped or the cabinet has been damaged.
- f When the projector exhibits a distinct change in performance-this indicates a need for servicing.

When replacement parts are required, be sure the service technician uses replacement parts specified by the manufacturer that have the same characteristics as the original parts. Unauthorized substitutions may result in fire, electric shock, or injury.

Upon completion of any service or repairs to this projector, ask the service technician to perform routine safety checks to determine that the projector is in safe operating condition.

## AC Power Cord Requirement

The AC Power Cord supplied with this projector meets the requirements for use in the country you purchased it.

### AC Power Cord for the United States and Canada:

The AC Power Cord used in the United States and Canada is listed by the Underwriters Laboratories (UL) and certified by the Canadian Standard Association (CSA).

The AC Power Cord has a grounding-type AC line plug. This is a safety feature to ensure the plug fits into the power outlet. Do not try to tamper with this safety feature. Should you be unable to insert the plug into the outlet, contact your electrician.

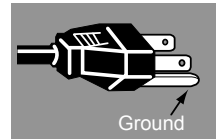

**THE SOCKET-OUTLET SHOULD BE INSTALLED NEAR THE EQUIPMENT AND EASILY ACCESSIBLE.**



For the U.S. and Canada, LAMP (S) INSIDE THIS PRODUCT CONTAIN MERCURY AND MUST BE RECYCLED OR DISPOSED OF ACCORDING TO LOCAL, MUNICIPAL, STATE, PROVINCIAL, OR FEDERAL LAWS.

For lamp recycling and disposal information please call 1-800-OK-CANON for the U.S. and Canada.



### Only for European Union and EEA (Norway, Iceland and Liechtenstein)

These symbols indicate that this product is not to be disposed of with your household waste, according to the WEEE Directive (2012/19/EU), the Battery Directive (2006/66/EC) and/or national legislation implementing those Directives.

If a chemical symbol is printed beneath the symbol shown above, in accordance with the Battery Directive, this indicates that a heavy metal (Hg = Mercury, Cd = Cadmium, Pb = Lead) is present in this battery or accumulator at a concentration above an applicable threshold specified in the Battery Directive.



This product should be handed over to a designated collection point, e.g., on an authorized one-for-one basis when you buy a new similar product or to an authorized collection site for recycling waste electrical and electronic equipment (EEE) and batteries and accumulators. Improper handling of this type of waste could have a possible impact on the environment and human health due to potentially hazardous substances that are generally associated with EEE. Your cooperation in the correct disposal of this product will contribute to the effective usage of natural resources.

For more information about the recycling of this product, please contact your local city office, waste authority, approved scheme or your household waste disposal service or visit [www.canon-europe.com/weee](http://www.canon-europe.com/weee), or [www.canon-europe.com/battery](http://www.canon-europe.com/battery).

### For CA, USA only

Included lithium battery contains Perchlorate Material - special handling may apply.

See [www.dtsc.ca.gov/hazardouswaste/perchlorate/](http://www.dtsc.ca.gov/hazardouswaste/perchlorate/) for details.

## **Federal Communication Commission Notice**

Multimedia Projector, Model: LV-WX320/LV-X320/LV-WX310ST/LV-X310ST

This device complies with Part 15 of the FCC Rules. Operation is subject to the following two conditions:

- (1) This device may not cause harmful interference, and
- (2) this device must accept any interference received, including interference that may cause undesired operation.

Note: This equipment has been tested and found to comply with the limits for a Class B digital device, pursuant to Part 15 of the FCC Rules. These limits are designed to provide reasonable protection against harmful interference in a residential installation. This equipment generates, uses and can radiate radio frequency energy and, if not installed and used in accordance with the instructions, may cause harmful interference to radio communications. However, there is no guarantee that interference will not occur in a particular installation. If this equipment does cause harmful interference to radio or television reception, which can be determined by turning the equipment off and on, the user is encouraged to try to correct the interference by one or more of the following measures:

- Reorient or relocate the receiving antenna.
- Increase the separation between the equipment and receiver.
- Connect the equipment into an outlet on a circuit different from that to which the receiver is connected.
- Consult the dealer or an experienced radio / TV technician for help.

The cable with a ferrite core provided with the projector must be used with this equipment in order to comply with Class B limits in Subpart B of Part 15 of the FCC Rules.

Use of a shielded cable is required to comply with class B limits in Subpart B of Part 15 of FCC Rules.

Do not make any changes or modifications to the equipment unless otherwise specified in the instructions. If such changes or modifications should be made, you could be required to stop operation of the equipment.

Canon U.S.A. Inc.

One Canon Park, Melville, New York 11747, U.S.A.

Tel No. 1-800-OK-CANON (1-800-652-2666)

## **Safety Symbols in this Manual**

This section describes the safety symbols used in this manual. Important projector safety information is identified by the following symbols. Always observe the safety information by these symbols.



### **Warning**

Denotes the risk of death or serious injury from improper handling if the information is not observed. To ensure safe use, always observe this information.



### **Caution**

Denotes the risk of injury from improper handling if the information is not observed. To ensure safe use, always observe this information.

---

## Precautions for Use

As this section contains important safety-related information, be sure to read the following carefully beforehand in order to use your projector correctly and safely.

### **Warning**

If the following situations occur, turn the power off, remove the power plug from the power outlet and contact the Canon Customer Support Center. Failure to do so could cause a fire or result in an electric shock.

- If smoke is emitted
- If an unusual smell or noise is emitted
- If a loud noise is heard and the light source turns off
- If water or other liquid has entered the projector
- If metal or any other foreign material has entered the projector
- If the projector is knocked over or dropped and the cabinet is damaged

### **Warning**

Pay attention to the following points for handling the power cord. Failure to pay attention to these points could cause a fire, electric shock or personal injury.

- Do not place any objects on the power cord and do not allow it to become trapped under the projector. The power cord may be damaged.
- Do not cover the power cord with a carpet.
- Do not excessively bend, twist, pull or make modifications to the power cord.
- Keep the power cord away from heaters and other sources of heat.
- Do not use the power cord when it is bent finely, coiled or bundled.
- Do not use a damaged power cord. If your power cord is damaged, contact the Canon Customer Support Center.
- Do not use any power cord other than the type that is included with this projector.
- Be sure to connect the ground wire of the power cord to ground. Failure to do so could result in an electric shock.
- Be sure to connect the ground wire before connecting the power plug to the outlet. Also when you disconnect the ground wire, be sure to unplug the power plug from the outlet beforehand.

### **Warning**

Pay attention to the following point to prevent the small parts from being accidentally swallowed by children.

- Small parts such as the remote control battery, battery holder and adjustable feet that were detached may be accidentally swallowed by small children, which may result in choking. Parents/Guardians should keep them out of reach of children. If swallowed, consult a doctor immediately.



## Warning

Pay attention to the following points regarding the power source, power plug and handling of the connector. Failure to do so could result in a fire, electric shock or personal injury.

- Do not use any power source with a voltage other than the voltage indicated (AC 100 – 240 V).
- Do not pull the power cord and be sure to hold the power plug or connector when removing. The cord could be damaged as a result.
- Do not insert any metal objects into the contact parts of the power plug or connector.
- Remove the power plug from the outlet before performing cleaning or maintenance of the projector.
- Do not remove the power plug or connector with wet hands.
- Insert the power plug and connector securely up to the base. Additionally, do not use a damaged power plug or an outlet that is loose.
- If using an extension cord attached to the outlet, make sure that the total electric power consumption of connected devices does not exceed the rated capacity.
- Periodically inspect the power plug and outlet and remove any dust or dirt from between the plug and the outlet.

## Precautions for Installation

### Warning

Pay attention to the following points regarding installation and handling of the projector. Failure to do so may cause a fire, electric shock or personal injury.

- Do not use the projector in a bathroom or shower room.
- Do not use the projector in rain or snow, by the sea, or in close proximity to a body of water.
- Do not place containers containing a liquid on top of the projector.
- Do not place the projector in any location where it will be exposed to oily smoke or steam, such as a kitchen work surface or table etc.
- Do not touch the projector itself, the power cord, or the cable if lightning strikes.

### Warning

Pay attention to the following points regarding installation and handling of the projector. Failure to do so may cause a fire, electric shock or personal injury.

- Do not move the projector until you have switched off the power, removed the power plug from the power outlet and unplugged any other cables.
- Do not remove the cabinet from the projector or disassemble it. The interior of the projector contains high-voltage components as well as parts that are hot. These could cause an electric shock or burn. If inspection, maintenance or repair is required, contact the Canon Customer Support Center.
- Do not disassemble or modify the projector (including consumable parts) or the remote control.
- Do not insert any object into vents in the projector, such as the air intake vent or exhaust vents.
- Do not place a pressurized can in front of the exhaust vents. The pressure of the contents of the can may increase due to heat from the exhaust vents and this could result in an explosion.
- As strong light beams are emitted while the projector is in use, do not look directly into the projector lens. Doing so could cause an eye injury. Pay particular attention in preventing young children to do so.
- When giving a presentation in front of the projector while it is projecting an image, conduct your presentation from a position where your shadow will not be cast on the screen and where you do not feel blinded by light from the projector.

## **Caution**

Pay attention to the following points regarding installation and handling of the projector.

- If the projector will not be used for a long period of time, be sure to remove the power plug from the power outlet to ensure safety. Failure to do so could cause a fire.
- The temperature of the cabinet around and above the exhaust vents can become hot during projector operation. Touching these areas during operation could cause burns to the hands. Do not touch these areas. Doing so may cause burns. Pay particular attention in preventing young children from touching these parts. Additionally, do not place any metal objects on these areas. Due to the heat from the projector, doing so could cause an accident or personal injury.

## **Caution**

Pay attention to the following points regarding installation and handling of the projector.

- Do not place any heavy objects on top of the projector or sit/stand on it. Pay particular attention to prevent small children from doing so. The projector may be knocked over and this could result in damage or a personal injury.
- Do not place the projector on an unstable or slanted surface. Doing so may cause the projector to fall or be knocked over and could result in a personal injury.
- Do not place any objects in front of the lens while the projector is operating. Doing so could cause a fire.
- When cleaning off dust or dirt from the projector lens etc., do not use any kind of spray that is flammable. As the temperature of the lamp inside the projector is high, it could ignite, causing a fire.
- If the projector is used for a long period of time, dust could accumulate inside the projector. This could cause a fire or malfunction. It is recommended that periodic maintenance of the projector be performed. For details of maintenance costs, contact the Canon Customer Support Center.

## **Precautions on the lamp**

This projector uses a high-pressure mercury lamp, which must be handled carefully and correctly as described below.

The mercury lamp has the following characteristics.

- Impact, abrasion, or use after the lamp's useful life has expired may damage lamps (which may be accompanied by a loud noise) or cause them to burn out.
- Useful life of lamps varies widely from lamp to lamp and depending on the environment of use. Lamps are not guaranteed to last for the same amount of time, and some lamps may fail sooner than others.
- The lamp will gradually become darker over time.

## **Warning**

When replacing the lamp, or when the lamp is damaged, pay attention to the following points. Failure to do so could result in an electric shock or personal injury.

- Be sure to remove the power plug from the power outlet before replacing the lamp.
- When the lamp is damaged, shards of glass may be scattered inside the projector. Contact the Canon Customer Support Center for cleaning and inspection of the projector interior and lamp replacement.

## **Caution**

When handling the lamp, pay attention to the following points.

- Be sure not to handle the lamp immediately after it has been used. Be sure to switch off the power and wait for approximately 45 minutes for the lamp and the projector to cool down sufficiently. Failure to do so could result in a burn or personal injury due to heat from the lamp or projector.
- When an instruction to replace the lamp has been displayed (LAMP Indicator Displays (See ["Timing of replacing the lamp" on page 63](#) for details)), the possibility of the lamp breaking will increase. Replace the lamp with a new one as soon as possible.
- If the lamp is damaged, gas inside the lamp (containing mercury) and dust may be emitted from the exhaust vents. If this happens, immediately open the windows and doors to provide ventilation to the room. If you inhale any gas emitted from the lamp or it has come into contact with your eyes or mouth, consult a doctor immediately.
- When disposing of a used mercury lamp, dispose of it in the same way as a fluorescent lamp and in accordance with the local regulations where you live.

## **Precautions for the remote control battery**

### **Warning**

Pay attention to the following points regarding handling of the battery. Failure to do so could result in a fire or injury.

- Do not place the battery in a fire or apply heat to, short circuit or disassemble the battery.
- Do not attempt to recharge the battery.
- Insert the battery in the correct + / - positions.
- If any liquid leaks from the battery and comes into contact with skin, wash off thoroughly with water.

## **Caution for viewing 3D content**

### **Caution**

Pay attention to the following points when viewing 3D content.

- Photosensitive patients, patients with heart disease, pregnant women, elderly people, and people with serious illness and/or with a history of epilepsy should not view 3D content.
- We advise that you should refrain from viewing 3D content if you are in bad physical condition, need sleep or have been drinking alcohol.
- Stop watching 3D content if you experience the following symptoms. If you experience such symptom, immediately stop viewing 3D content and take a break until the symptom has subsided.
  - You see doubly-blurred images or you cannot view the image stereoscopically.
  - You feel fatigue or discomfort.
- Take breaks when viewing 3D content for an extended period of time. As this may cause eye fatigue. Viewing 3D content for an extended period of time or viewing them from an oblique angle can cause eye strain.
- Parents should accompany and monitor their children as children cannot properly express discomfort with 3D content viewing. Children who are six year of age or younger should not view 3D content.
- The optimum 3D viewing distance from the screen is about 3 times of the vertical screen size or more and your eyes should be level with the screen.

## For Safe Use

Pay attention to the following points when carrying or transporting the projector.

- This projector is a precision instrument. Do not knock it over or subject it to impacts. Doing so may cause a malfunction.
- Do not reuse any packaging or shock-absorbent materials that were supplied with the projector at the time of purchase for transporting or shipping the projector. Protection of the projector cannot be guaranteed if used packaging or shock-absorbent materials are reused. Fragments from shock-absorbent material may also enter the interior of the projector which could cause a malfunction.
- Disconnect the cables connected to the projector. Carrying the projector with the cables attached may cause an accident.
- Retract the adjustable feet.
- Attach the lens cap to protect the lens.

Pay attention to the following points when installing or using the projector.

- Be sure to install the projector in a location where the air intake and exhaust vents are separated from the wall by more than 50 cm (1.6'). Failure to do so could cause a malfunction.
- Do not install the projector in a location that is damp, or where there is a lot of dust, oily smoke or tobacco smoke. Doing so could cause contamination of optical components such as the lens and the mirror and may result in deterioration of image quality.
- Do not touch the lens with bare hands. Doing so may result in deterioration of image quality.
- If the projector is suddenly moved from a location where the temperature is low to a location where the temperature is high, or if the temperature in the location where the projector is installed increases suddenly, moisture in the air could cause condensation to form on the projector lens or mirror. This may cause a blurred image. Wait until the condensation has evaporated for the image projected to return to normal.
- Do not install the projector in a location where the temperature is high or low. Doing so may cause a malfunction.
  - Operating temperature: 0°C (32°F) to 40°C (104°F)
  - Humidity level: 10% to 90%
  - Storage temperature: -20°C (-4°F) to 60°C (140°F)
- Do not install the projector near high-voltage electrical power lines or an electrical power source.
- Do not use the projector on a soft surface such as carpet or sponge mat, etc. Doing so could cause heat to build up inside the projector and this could result in a malfunction.
- Do not block the air intake or exhaust vents of the cooling fan. Doing so could cause heat to build up inside the projector and may cause a malfunction.
- Do not place any objects on top of the projector that may change shape or color due to heat.
- When using the projector at altitudes greater than 1500 m (4921'), please turn on the High Altitude Mode.
- Please do not brush or rub the surface of the top plate of the projector. The surface may be damaged.

# Contents of package

---

LV-WX320/LV-X320

LV-WX310ST/LV-X310ST

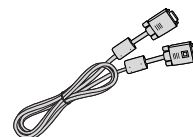
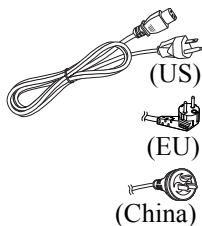
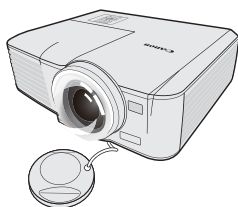
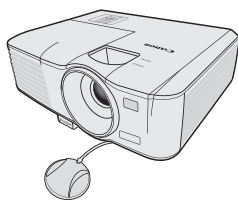

---

Projector

Power cord 1.8 m (70.8")

Computer cable 1.8 m (70.8")  
(5K.1VC09.501)

---

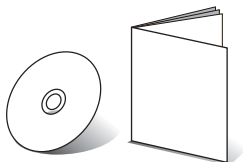

CD & QSG Important Information

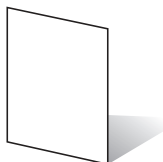

Warranty card

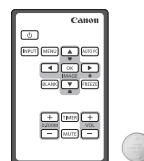

Remote control  
(type number: LV-RC08)  
Battery (type number: CR2025)

---

# Projector exterior view

## Front/upper side

LV-WX320/LV-X320

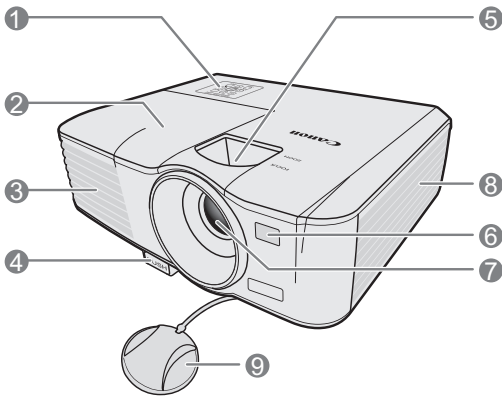

1. External control panel  
(See "Projector" on page 15 for details.)
2. Lamp cover
3. Vent (heated air exhaust)
4. Quick-release button
5. Focus ring and Zoom ring (LV-WX320/LV-X320)  
Focus ring (LV-WX310ST/LV-X310ST)
6. Front IR remote sensor
7. Projection lens
8. Vent (air intake)
9. Lens cap

LV-WX310ST/LV-X310ST

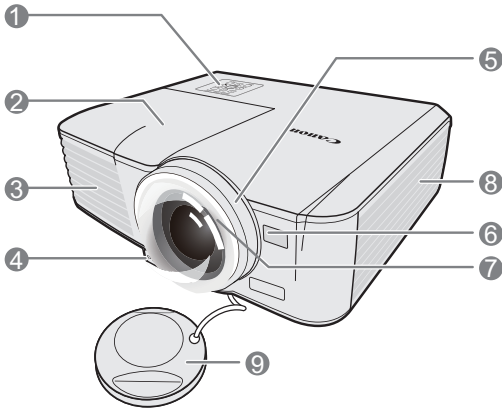

## Rear/lower side

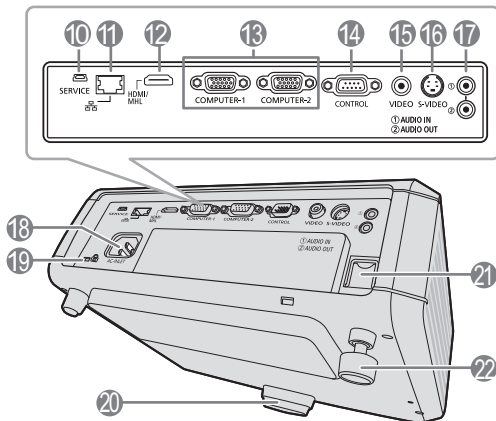

10. SERVICE port
11. LAN (RJ-45) port
12. HDMI/MHL input terminal
13. PC input terminal x 2
14. CONTROL port
15. Video input terminal
16. S-Video input terminal
17. Audio input terminal  
Audio output terminal
18. AC power cord inlet
19. Kensington lock
20. Quick-release foot
21. Security bar
22. Rear adjuster foot

# Controls and functions

## Projector

LV-WX320/LV-X320

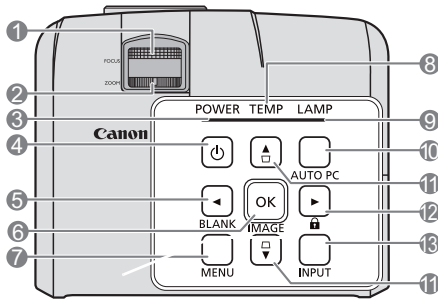

LV-WX310ST/LV-X310ST

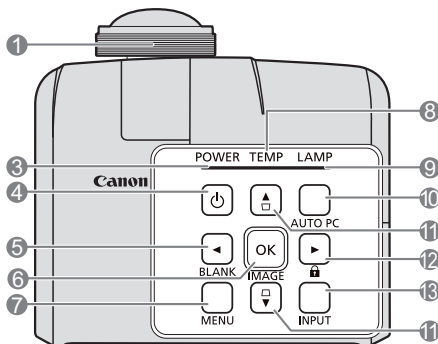

### 1. Focus ring

Adjusts the focus of the projected image. See ["Fine-tuning the image size and clarity" on page 35](#) for details.

### 2. Zoom ring (LV-WX320/LV-X320)

Adjusts the size of the image. See ["Fine-tuning the image size and clarity" on page 35](#) for details.

### 3. POWER indicator light

Lights up or flashes when the projector is under operation. See ["Indicators" on page 67](#) for details.

### 4. POWER (ON/STANDBY)

Toggles the projector between standby mode and on. See ["Starting up the projector" on page 30](#) and ["Shutting down the projector" on page 44](#) for details.

### 5. Left/BLANK

Used to hide the screen picture. See ["Hiding the image" on page 43](#) for details.

### 6. OK/IMAGE

Enacts the selected On-Screen Display (OSD) menu item.

Selects an available picture setup mode. See ["Selecting a image mode" on page 39](#) for details.

### 7. MENU

Turns on the On-Screen Display (OSD) menu. Goes back to previous OSD menu, exits and saves menu settings. See ["Using the menus" on page 31](#) for details.

### 8. TEMPERature indicator light

Lights up red if the projector's temperature becomes too high. See ["Indicators" on page 67](#) for details.

### 9. LAMP indicator light

Indicates the status of the lamp. Lights up or flashes when the lamp has developed a problem. See ["Indicators" on page 67](#) for details.

### 10. AUTO PC

Automatically determines the best picture timings for the displayed image. See ["Auto-adjusting the image" on page 35](#) for details.

### 11. Keystone/Arrow keys ( / Up, / Down)

Manually corrects distorted images resulting from an angled projection. See ["Correcting keystone" on page 36](#) for details.

### 12. Right/

Activates panel key lock. See ["Locking control keys" on page 43](#) for details.

When the On-Screen Display (OSD) menu is activated, the #5, #11, and #12 keys are used as directional arrows to select the desired menu items and to make adjustments. See ["Using the menus" on page 31](#) for details.

### 13. INPUT

Displays the source selection bar. See ["Switching input signal" on page 34](#) for details.



**When you are under the MHL connection mode and the projector OSD is off, these buttons are available for controlling your smart device: arrow keys, OK/IMAGE, AUTO PC.**

### 5, 11 and 12: arrows keys

Arrows keys are available for controlling your smart device.

### 6. OK/IMAGE

Use the key to confirm the selection on the OSD of your smart device.

### 10. AUTO PC

Use the key to return or exit the OSD menu of your smart device.

To enter the MHL connection mode, connect a MHL device (See ["Connecting a MHL-compatible smart device" on page 26](#) for details.) and switch the input signal to HDMI/MHL (See ["Switching input signal" on page 34](#) for details.).

Attention of the MHL device connection (See ["Connecting a MHL-compatible smart device" on page 26](#) for details.)

## Remote control: LV-RC08

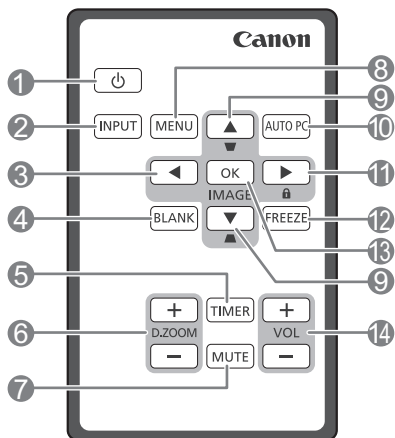

1. **⏻ POWER (ON/STANDBY)**  
Toggles the projector between standby mode and on. See ["Starting up the projector" on page 30](#) and ["Shutting down the projector" on page 44](#) for details.
2. **INPUT**  
Displays the source selection bar. See ["Switching input signal" on page 34](#) for details.
3. **◀ Left**  
Selects the desired menu items and makes adjustments. See ["Using the menus" on page 31](#) for details.
4. **BLANK**  
Used to hide the screen picture. See ["Hiding the image" on page 43](#) for details.
5. **TIMER**  
Activates or adjusts some basic settings of an on-screen timer. See ["Using the TIMER key" on page 42](#) for details.
6. **D.ZOOM (+, -)**  
Magnifies or reduces the projected picture size. See ["Magnifying and searching for details" on page 37](#) for details.
7. **MUTE**  
Temporarily mutes the audio. See ["Adjusting the sound" on page 44](#) for details.
8. **MENU**  
Turns on the On-Screen Display (OSD) menu. Goes back to previous OSD menu, exits and saves menu settings. See ["Using the menus" on page 31](#) for details.

9. **Keystone/Arrow keys (◻/▲Up, ◻/▼Down)**  
Manually corrects distorted images resulting from an angled projection. See ["Correcting keystone" on page 36](#) for details.
10. **AUTO PC**  
Automatically determines the best picture timings for the displayed image. See ["Auto-adjusting the image" on page 35](#) for details.
11. **▶ Right/🔒**  
Activates panel key lock. See ["Locking control keys" on page 43](#) for details.  
When the On-Screen Display (OSD) menu is activated, the #3, #9 and #11 keys are used as directional arrows to select the desired menu items and to make adjustments. See ["Using the menus" on page 31](#) for details.
12. **FREEZE**  
Freezes the projected image. See ["Freezing the image" on page 43](#) for details.
13. **OK/IMAGE**  
Enacts the selected On-Screen Display (OSD) menu item.  
Selects an available picture setup mode. See ["Selecting a image mode" on page 39](#) for details.
14. **VOLUME keys (+, -)**  
Adjusts the sound level. See ["Adjusting the sound" on page 44](#) for details.

 **When you are under the MHL connection mode and the projector OSD is off, these buttons are available for controlling your smart device: arrow keys, OK/IMAGE, AUTO PC.**

**3, 9 and 11: arrows keys**  
**Arrows keys are available for controlling your smart device.**

**10. AUTO PC**  
**Use the key to return or exit the OSD menu of your smart device.**

**13. OK/IMAGE**  
**Use the key to confirm the selection on the OSD of your smart device.**

**To enter the MHL connection mode, connect a MHL device (See ["Connecting a MHL-compatible smart device" on page 26](#) for details.) and switch the input signal to HDMI/MHL (See ["Switching input signal" on page 34](#) for details.).**

**Attention of the MHL device connection (See ["Connecting a MHL-compatible smart device" on page 26](#) for details.)**



## Using the remote control for the first time

Pull the tab before using the remote control.

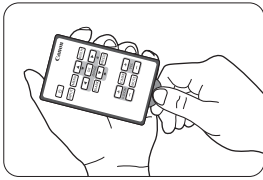

## Remote control effective range

Infra-Red (IR) remote control sensor is located on the front of the projector. The distance between the remote control and the sensor should not exceed 8 meters (~ 26 feet).

Make sure that there are no obstacles between the remote control and the IR sensor on the projector that might obstruct the infra-red beam.

- ⚠ • **You may not be able to perform operations if there are any obstacles between the remote control and the projector.**
- **You may not be able to operate the remote control if direct sunlight or strong light is shining onto the remote IR receiver.**

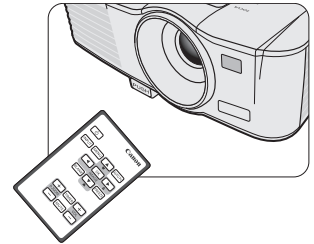

## Replacing the remote control battery

1. Pull out the battery holder.

👉 **Please follow the illustrated instructions. Push and hold the locking arm while pulling out the battery holder.**

2. Insert the new battery in the holder. Note the positive polarity should face outward.
3. Push the holder into the remote control.

- ⚠ • **Risk of explosion if battery is replaced by an incorrect type.**
- **Dispose of used batteries according to the instructions.**
- **Use of a battery of wrong type may cause explosion. Use Lithium coin battery, type CR2025 only.**
- **Dispose of used batteries according to your local regulations. Discard used battery promptly. Batteries may explode if mistreated. Do not recharge, disassemble, or dispose of in fire.**
- **Be careful in handling the battery according to the instructions.**
- **Load the battery with its positive (+) and negative (-) sides correctly oriented as indicated on the remote control.**
- **Keep batteries out of reach of children and pets.**
- **The remote control battery and battery holders can be a choking hazard if swallowed accidentally by small children. Make sure these are placed out of the reach of children. If they are swallowed accidentally, contact a physician immediately.**
- **Remove the battery if the remote control is not used for a long time.**
- **Keep battery in original package until ready to use.**
- **Never put battery in mouth for any reason as it can easily be accidentally swallowed. If battery is accidentally swallowed, contact your physician or your poison control center.**
- **Dispose of the used battery with cellophane tape wrapping both ends of it.**
- **If any liquid leaks from the battery and comes into contact with skin, wash it off thoroughly with water.**

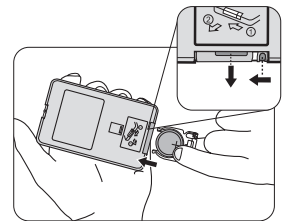

---

### **Third party software**

This product includes third party software modules.

- uIP (micro IP) version 0.9

Please see the below licence text concerning the licence condition.

Copyright © 2001-2003, Adam Dunkels.

All rights reserved.

Redistribution and use in source and binary forms, with or without modification, are permitted provided that the following conditions are met:

1. Redistributions of source code must retain the above copyright notice, this list of conditions and the following disclaimer.
2. Redistributions in binary form must reproduce the above copyright notice, this list of conditions and the following disclaimer in the documentation and/or other materials provided with the distribution.
3. The name of the author may not be used to endorse or promote products derived from this software without specific prior written permission.

THIS SOFTWARE IS PROVIDED BY THE AUTHOR "AS IS" AND ANY EXPRESS OR IMPLIED WARRANTIES, INCLUDING, BUT NOT LIMITED TO, THE IMPLIED WARRANTIES OF MERCHANTABILITY AND FITNESS FOR A PARTICULAR PURPOSE ARE DISCLAIMED. IN NO EVENT SHALL THE AUTHOR BE LIABLE FOR ANY DIRECT, INDIRECT, INCIDENTAL, SPECIAL, EXEMPLARY, OR CONSEQUENTIAL DAMAGES (INCLUDING, BUT NOT LIMITED TO, PROCUREMENT OF SUBSTITUTE GOODS OR SERVICES; LOSS OF USE, DATA, OR PROFITS; OR BUSINESS INTERRUPTION) HOWEVER CAUSED AND ON ANY THEORY OF LIABILITY, WHETHER IN CONTRACT, STRICT LIABILITY, OR TORT (INCLUDING NEGLIGENCE OR OTHERWISE) ARISING IN ANY WAY OUT OF THE USE OF THIS SOFTWARE, EVEN IF ADVISED OF THE POSSIBILITY OF SUCH DAMAGE.

### **Third party software support**

Canon Inc., Canon's affiliated companies, as well as sales companies do not offer any support services for these programs. We are unable to respond to questions or inquiries from you or any other parties regarding these programs.

# Positioning your projector

## Choosing a location

Your room layout or personal preference will dictate which installation location you select. Take into consideration the size and position of your screen, the location of a suitable power outlet, as well as the location and distance between the projector and the rest of your equipment.

Your projector is designed to be installed in one of the possible installation locations:

### 1. Front Table

Select this location with the projector placed near the floor in front of the screen. This is the most common way to position the projector for quick setup and portability.

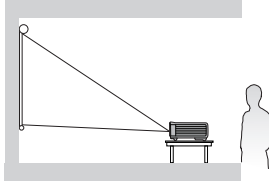

### 2. Rear Table

Select this location with the projector placed near the floor behind the screen.

Note that a special rear projection screen is required.

Set **Rear Table** in the **SYSTEM SETUP: Basic > Projector Position** menu after you turn the projector on.

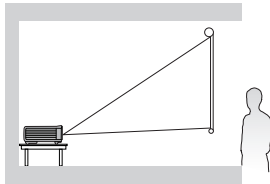

### 3. Rear Ceiling

Select this location with the projector suspended upside-down from the ceiling behind the screen.

Note that a special rear projection screen and qualified projector ceiling mount kit are required for this installation location.

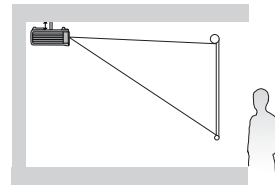

Set **Rear Ceiling** in the **SYSTEM SETUP: Basic > Projector Position** menu after you turn the projector on.

### 4. Front Ceiling

Select this location with the projector suspended upside-down from the ceiling in front of the screen.

Purchase a qualified projector ceiling mount kit from your dealer to mount your projector on the ceiling.

Set **Front Ceiling** in the **SYSTEM SETUP: Basic > Projector Position** menu after you turn the projector on.

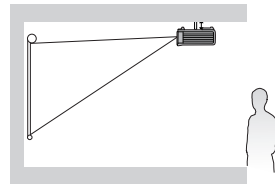

For ceiling mounting, you need the ceiling mount kit to be available for this projector. Ask a specialist for installation. For details, consult your dealer.

- The warranty on this projector does not cover any damage caused by use of any non-recommended ceiling mount kit or installation of the ceiling mount kit in an improper location.
- When the projector is mounted on the ceiling, images may appear darker than those projected in the case of tabletop mounting. This isn't a product malfunction.

---

## Obtaining a preferred projected image size

The distance from the projector lens to the screen, the zoom setting (if available), and the video format each factors in the projected image size.

4:3 is the native aspect ratio of LV-X320/LV-X310ST. To be able to project a complete 16:9 (widescreen) aspect ratio image, the projector can resize and scale a widescreen image to the projector's native aspect width. This will result in a proportionally smaller height equivalent to 75% of the projector's native aspect height.

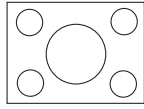

4:3 aspect image in a 4:3 aspect display area

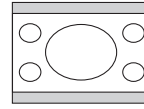

16:9 aspect image scaled to a 4:3 aspect display area

Thus, a 16:9 aspect image will not utilize 25% of the height of a 4:3 aspect image displayed by this projector. This will be seen as darkened (unlit) bars along the top and bottom (vertical 12.5% height respectively) of the 4:3 projection display area whenever displaying a scaled 16:9 aspect image in the vertical center of the 4:3 projection display area.

16:10 is the native aspect ratio of LV-WX320/LV-WX310ST. To be able to project a complete 16:9 (widescreen) aspect ratio image, the projector can resize and scale a widescreen image to the projector's native aspect width. This will result in a proportionally smaller height equivalent to 90% of the projector's native aspect height.

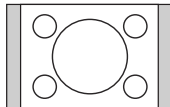

4:3 aspect image in a 16:10 aspect display area

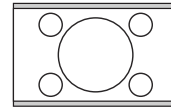

16:9 aspect image scaled to a 16:10 aspect display area

Thus, a 16:9 aspect image will not utilize 10% of the height of a 16:10 aspect image displayed by this projector. This will be seen as darkened (unlit) bars along the top and bottom (vertical 5% height respectively) of the 16:10 projection display area whenever displaying a scaled 16:9 aspect image in the vertical center of the 16:10 projection display area.

The projector should always be placed horizontally level (like flat on a table), and positioned directly perpendicular (90° right-angle square) to the horizontal center of the screen. This prevents image distortion caused by angled projections (or projecting onto angled surfaces).

The modern digital projector does not project directly forward (like older style reel-to-reel film projectors did). Instead, digital projectors are designed to project at a slightly upward angle above the horizontal plane of the projector. This is so that they can be readily placed on a table and will project forward and upwards onto a screen positioned so that the bottom edge of the screen is above the level of the table (and everyone in the room can see the screen).

You can see from the diagram on page 23, that this type of projection causes the bottom edge of the projected image to be vertically offset from the horizontal plane of the projector.

If the projector is positioned further away from the screen, the projected image size increases, and the vertical offset also increases proportionately.

When determining the position of the screen and projector, you will need to account for both the projected image size and the vertical offset dimension, which are directly proportional to the projection distance.

### When fine streaks are seen on projected images

This is due to interference with the screen surface and is not a mal-function. Replace the screen or displace the focus a little.

---

## How to determine the position of the projector for a given screen size

1. Select your image size.
2. Refer to the table and find the closest match to your image size in the left columns labeled "[Image size](#)". Using this value, look across this row to the right to find the corresponding average distance from screen value in the column labeled "[Distance from the screen: L](#)". This is the projection distance.
3. On that same row, look across to the right column and make note of the "[Hd](#)" value. This will determine the final vertical offset placement of the projector in relation to the edge of the image.
4. The recommended position for the projector is aligned perpendicular to the horizontal center of the screen, at the distance from the screen determined in step 2 above, and offset by the value determined in step 3 above.

<Example>

LV-X310ST: If you are using a 4:3 aspect ratio, 100-inch screen, distance from the screen is 1.23 m and with a vertical offset of 22.9 cm.

If you place the projector in a different position (to that recommended), you will have to tilt it down or up to center the image on the screen. In these situations, some image distortion will occur. Use the Keystone function to correct the distortion. See "[Correcting keystone](#)" on page 36 for details.

## How to determine the recommended screen size for a given distance

This method can be used for situations where you have purchased this projector and would like to know what screen size will fit in your room.

The maximum screen size is limited by the physical space available in your room.

1. Measure the distance between the projector and where you want to position the screen. This is the projection distance.
2. Refer to the table and find the closest match to your measurement in the distance from the Image size column. If the min and max values are available on the table, check that your measured distance is between the min and max distances listed on either side of the average distance value.
3. Using this value, look across that row to the left to find the corresponding "[Image size](#)". That is the projected image size of the projector at that projection distance.
4. On that same row, look across to the right column and make note of the "[Hd](#)" value. This will determine the final placement of the screen in relation to the horizontal plane of the projector.

<Example>

LV-X310ST: If your measured projection distance was 1 m and your screen aspect ratio is 4:3, the closest match in the "[Distance from the screen: L](#)" column is 0.99 m. Looking across this row shows that a 80-inch screen is required.

## Layout of the projector (LV-WX320/LV-X320)

Image size varies depending on the distance between the screen and the projector.

### Front projection

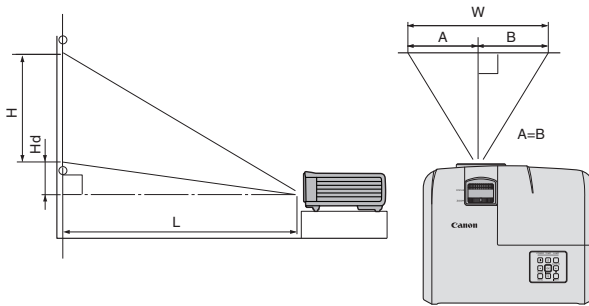

L: Between the screen and the front edge of the projector  
H: Height of the projected image

### LV-X320 (4:3)

Image size						Distance from the screen: L				Hd	
Diagonal Size		Width: W		Height: H		Shortest (Wide)		Longest (Tele)			
inch	m	inch	cm	inch	cm	inch	m	inch	m	inch	cm
60	1.5	48	122	36	91	94	2.4	103	2.6	3.6	9.1
70	1.8	56	142	42	107	110	2.8	120	3.1	4.2	10.7
80	2.0	64	163	48	122	125	3.2	138	3.5	4.8	12.2
90	2.3	72	183	54	137	141	3.6	155	3.9	5.4	13.7
100	2.5	80	203	60	152	156	4.0	172	4.4	6.0	15.2
120	3.1	96	244	72	183	188	4.8	207	5.2	7.2	18.3
150	3.8	120	305	90	229	235	6.0	258	6.6	9.0	22.9
180	4.6	144	366	108	274	282	7.2	310	7.9	10.8	27.4

### LV-WX320 (16:10)

Image size						Distance from the screen: L				Hd	
Diagonal Size		Width: W		Height: H		Shortest (Wide)		Longest (Tele)			
inch	m	inch	cm	inch	cm	inch	m	inch	m	inch	cm
60	1.5	51	129	32	81	79	2.0	87	2.2	0.0	0
70	1.8	59	151	37	94	92	2.3	101	2.6	0.0	0
80	2.0	68	172	42	108	105	2.7	115	2.9	0.0	0
90	2.3	76	194	48	121	118	3.0	130	3.3	0.0	0
100	2.5	85	215	53	135	131	3.3	144	3.7	0.0	0
120	3.1	102	258	64	162	157	4.0	173	4.4	0.0	0
150	3.8	127	323	79	202	197	5.0	217	5.5	0.0	0
180	4.6	153	388	95	242	236	6.0	260	6.6	0.0	0

☞ The above figures are approximate and may be slightly different from the actual measurements. Canon recommends that if you intend to permanently install the projector, you should physically test the projection size and distance using the actual projector in suit before you permanently install it, so as to make allowance for this projector's optical characteristics. This will help you determine the exact mounting position so that it best suits your installation location.

## Layout of the projector (LV-WX310ST/LV-X310ST)

Image size varies depending on the distance between the screen and the projector.

### Front projection

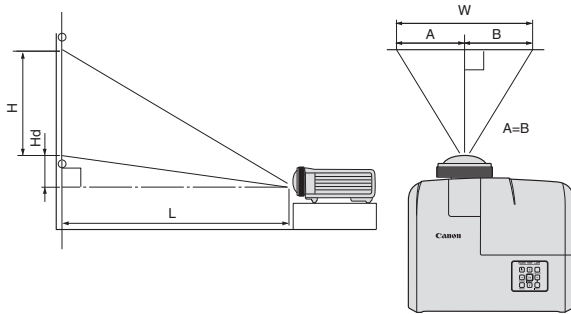

L: Between the screen and the front edge of the projector  
H: Height of the projected image

### LV-X310ST (4:3)

Image size						Distance from the screen: L		Hd	
Diagonal Size		Width: W		Height: H					
inch	m	inch	cm	inch	cm	inch	m	inch	cm
60	1.5	48	122	36	91	29	0.74	5.4	13.7
70	1.8	56	142	42	107	34	0.86	6.3	16.0
80	2.0	64	163	48	122	39	0.99	7.2	18.3
90	2.3	72	183	54	137	44	1.11	8.1	20.6
100	2.5	80	203	60	152	49	1.23	9.0	22.9
120	3.0	96	244	72	183	58	1.48	10.8	27.4

### LV-WX310ST (16:10)

Image size						Distance from the screen: L		Hd	
Diagonal Size		Width: W		Height: H					
inch	m	inch	cm	inch	cm	inch	m	inch	cm
70	1.8	59	151	37	94	29	0.74	1.9	4.7
80	2.0	68	172	42	108	33	0.84	2.1	5.4
90	2.3	76	194	48	121	37	0.95	2.4	6.1
100	2.5	85	215	53	135	41	1.05	2.6	6.7
120	3.0	102	258	64	162	50	1.26	3.2	8.1

☞ The above figures are approximate and may be slightly different from the actual measurements. Canon recommends that if you intend to permanently install the projector, you should physically test the projection size and distance using the actual projector in suit before you permanently install it, so as to make allowance for this projector's optical characteristics. This will help you determine the exact mounting position so that it best suits your installation location.

# Connection

When connecting a signal source to the projector, be sure to:

1. Turn all equipment off before making any connections.
2. Use the correct signal cables for each source.
3. Ensure the cables are firmly inserted.

- **See the user's manual of each device for details about its connections.**
- **Contact your dealer for details about its connections.**
- **In the connections shown below, some cables may not be included with the projector. They are commercially available from electronics stores.**

## Connecting a computer or monitor

### Connecting a computer

The projector provides a PC input terminal that allows you to connect it to both IBM<sup>®</sup> compatibles and Macintosh<sup>®</sup> computers. A Mac adapter is needed if you are connecting legacy version Macintosh computers.

#### To connect the projector to a notebook or desktop computer:

1. Take the supplied Computer cable and connect one end to the D-Sub output terminal of the computer.
2. Connect the other end of the Computer cable to the **COMPUTER-1** or **COMPUTER-2** signal input terminal of the projector.
3. If you wish to make use of the projector speaker in your presentations, take a suitable audio cable and connect one end of the cable to the audio output terminal of the computer, and the other end to the **AUDIO IN** terminal of the projector.
4. If you wish, you can use another suitable audio cable and connect one end of the cable to the **AUDIO OUT** terminal of the projector, and the other end to your external speakers (not supplied).

Once connected, the audio can be controlled by the projector On-Screen Display (OSD) menus. See "[Adjusting the sound](#)" on page 44 for details.

The final connection path should be like that shown in the following diagram:

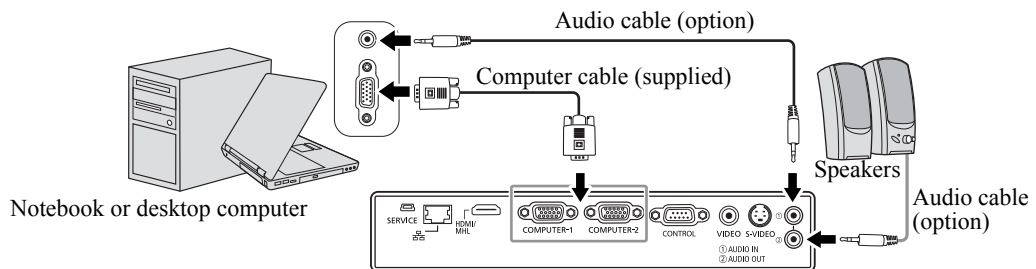

- **Many notebooks do not turn on their external video ports when connected to a projector. Usually a key combo like FN + F3 or CRT/LCD key turns the external display on/off. Locate a function key labeled CRT/LCD or a function key with a monitor symbol on the notebook. Press FN and the labeled function key simultaneously. Refer to your notebook's documentation to find your notebook's key combination.**

- **When you use a longer Computer cable instead of the provided cable, the image may not be projected correctly.**
- **Some computers require additional connectors or analog RGB output adapters to be connected with this projector.**



---

## Connecting Video source devices

You can connect your projector to various Video source devices that provide any one of the following output sockets:

- HDMI
- Component Video
- S-Video
- Video (composite)

You need only connect the projector to a Video source device using just one of the above connecting methods, however each provides a different level of video quality. The method you choose will most likely depend upon the availability of matching terminals on both the projector and the Video source device as described below:

HDMI (High-Definition Multimedia Interface) supports uncompressed video data transmission between compatible devices like DTV tuners, DVD players and displays over a single cable. It provides pure digital viewing experience. See ["Connecting an HDMI device" on page 26](#) for how to connect the projector to an HDMI device.

Digital TV tuner and DVD players output Component Video natively, so if available on your devices, this should be your connection method of choice in preference to (composite) Video. See ["Connecting a Component Video source device" on page 27](#) for how to connect the projector to a component video device.

If you have both composite Video and S-Video output terminals on your Video source device, you should elect to use the S-Video option. See ["Connecting an S-Video source device" on page 28](#) for how to connect the projector to an S-Video device.

If you have only composite Video output terminals on your Video source device, connect to Composite Video input. See ["Connecting a composite Video source device" on page 29](#) for how to connect the projector to a composite Video device.

## Connecting an HDMI device

You should use an HDMI cable when making connection between the projector and HDMI devices.

### To connect the projector to an HDMI device:

1. Take an HDMI cable and connect one end to the HDMI output terminal of the video device.
2. Connect the other end of the cable to the **HDMI/MHL** input terminal on the projector.

The final connection path should be like that shown in the following diagram:

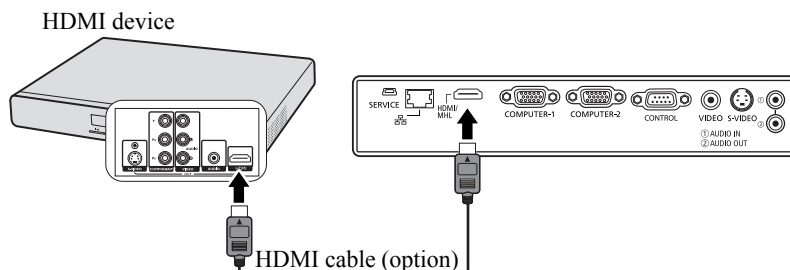

☞ When you connect this projector and an HDMI device (such as a DVD player) via the HDMI terminal, black color may appear dark and deep, depending on the type of the connected device.

- This depends on the black level setting of the connected device. There are two kinds of methods to digitally transfer image data, in which different black level settings are employed respectively. Therefore, the specifications of the signals output from DVD players differ, depending on the type of the digital data transfer method they use.
- Some DVD players are provided with a function to switch the methods to output digital signals. When your DVD player is provided with such function, set it as follows.

**EXPAND or ENHANCED -> NORMAL**

- See the User's Manual of your DVD player for details.
- When you switch to HDMI input, the projected picture may display wrong colors for about 1 second. This is not product malfunction.

## Connecting a MHL-compatible smart device

You should use a MHL cable when making connection between the projector and the smart devices.

### To connect the projector to a smart device:

1. Take an MHL cable and connect one end to the MHL output terminal of the smart device.
2. Connect the other end of the cable to the **HDMI/MHL** input terminal on the projector.

The final connection path should be like that shown in the following diagram:

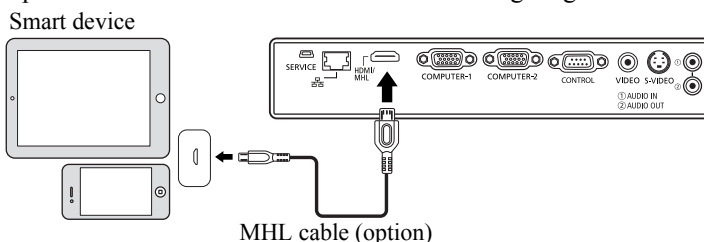

☞ When a MHL-compatible smart device is connected and the input signal is HDMI/MHL, some buttons on the projector and remote control are available for controlling your smart device. See "[Controls and functions](#)" on page 15 for details.

- ⚠ Use a MHL cable (available on the market) and MHL-HDMI conversion adapter (available on the market) that comply with the MHL standard. When non-compliant items are used, image projection may not be possible, or the connected device may malfunction or generate heat.

- Images may not be displayed correctly depending on the connected device type and the settings.
- Operation may differ or the intended operation may not be performed when using the controls on the projector and the remote controller, depending on the connected device.
- When using a MHL-HDMI conversion adapter (available on the market), the connected device cannot be operated using the controls on the projector and the remote controller.
- When images cannot be projected properly, disconnect and reconnect the MHL cable.
- Operation is not guaranteed for all connected devices.

## Connecting a Component Video source device

Examine your Video source device to determine if it has a set of unused Component Video output sockets available:

- If so, you can continue with this procedure.
- If not, you will need to reassess which method you can use to connect to the device.

### To connect the projector to a Component Video source device:

1. Take a Component Video to RGB (D-Sub) adaptor cable and connect the end with 3 RCA type connectors to the Component Video output sockets of the Video source device. Match the color of the plugs to the color of the sockets; green to green, blue to blue, and red to red.
2. Connect the other end of the Component Video to RGB (D-Sub) adaptor cable (with a D-Sub type connector) to the **COMPUTER-1** or **COMPUTER-2** terminal on the projector.
3. If you wish to make use of the projector speaker in your presentations, take a suitable audio cable and connect one end of the cable to the audio output terminal of the computer, and the other end to the **AUDIO IN** terminal of the projector.
4. If you wish, you can use another suitable audio cable and connect one end of the cable to the **AUDIO OUT** terminal of the projector, and the other end to your external speakers (not supplied).

Once connected, the audio can be controlled by the projector On-Screen Display (OSD) menus. See ["Adjusting the sound" on page 44](#) for details.

The final connection path should be like that shown in the following diagram:

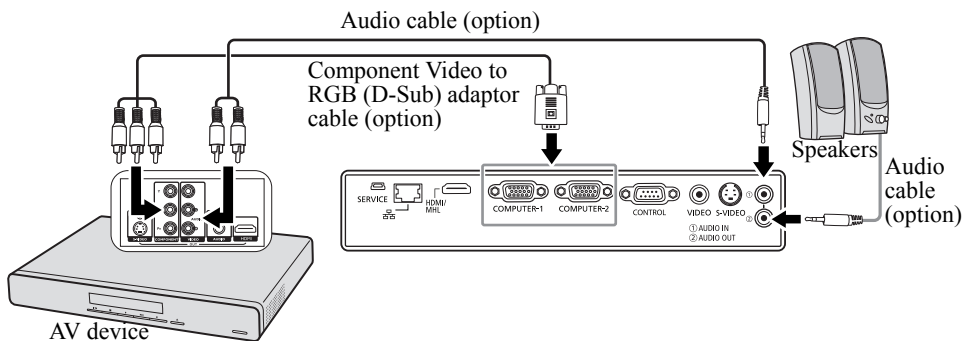

If the selected video image is not displayed after the projector is turned on and the correct video source has been selected, check that the Video source device is turned on and operating correctly. Also check that the signal cables have been connected correctly.

## Connecting an S-Video source device

Examine your Video source device to determine if it has an unused S-Video output terminal available:

- If so, you can continue with this procedure.
- If not, you will need to reassess which method you can use to connect to the device.

### To connect the projector to an S-Video source device:

1. Take an S-Video cable and connect one end to the S-Video output terminal of the Video source device.
2. Connect the other end of the S-Video cable to the **S-VIDEO** terminal on the projector.
3. If you wish to make use of the projector speaker in your presentations, take a suitable audio cable and connect one end of the cable to the audio output terminal of the computer, and the other end to the **AUDIO IN** terminal of the projector.
4. If you wish, you can use another suitable audio cable and connect one end of the cable to the **AUDIO OUT** terminal of the projector, and the other end to your external speakers (not supplied).

Once connected, the audio can be controlled by the projector On-Screen Display (OSD) menus. See ["Adjusting the sound" on page 44](#) for details.

The final connection path should be like that shown in the following diagram:

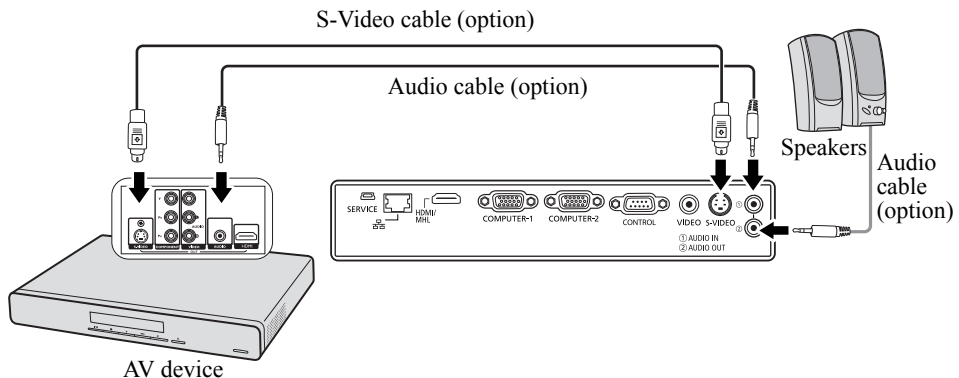

- **If the selected video image is not displayed after the projector is turned on and the correct video source has been selected, check that the Video source device is turned on and operating correctly. Also check that the signal cables have been connected correctly.**
- **If you have already made a Component Video connection between the projector and this S-Video source device, you need not connect to this device using an S-Video connection as this makes an unnecessary second connection of poorer picture quality. See ["Connecting Video source devices" on page 25](#) for details.**

## Connecting a composite Video source device

Examine your Video source device to determine if it has a set of unused composite Video output sockets available:

- If so, you can continue with this procedure.
- If not, you will need to reassess which method you can use to connect to the device.

### To connect the projector to a composite Video source device:

1. Take a Video cable and connect one end to the composite Video output terminal of the Video source device.
2. Connect the other end of the Video cable to the **VIDEO** terminal on the projector.
3. If you wish to make use of the projector speaker in your presentations, take a suitable audio cable and connect one end of the cable to the audio output terminal of the computer, and the other end to the **AUDIO IN** terminal of the projector.
4. If you wish, you can use another suitable audio cable and connect one end of the cable to the **AUDIO OUT** terminal of the projector, and the other end to your external speakers (not supplied).

Once connected, the audio can be controlled by the projector On-Screen Display (OSD) menus. See ["Adjusting the sound" on page 44](#) for details.

The final connection path should be like that shown in the following diagram:

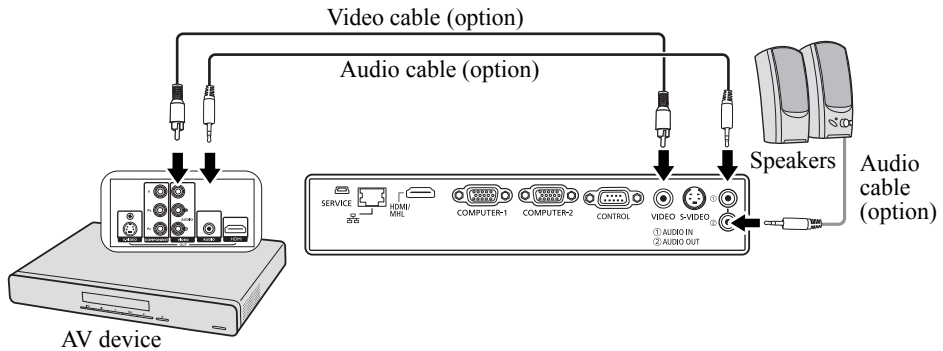

- **If the selected video image is not displayed after the projector is turned on and the correct video source has been selected, check that the Video source device is turned on and operating correctly. Also check that the signal cables have been connected correctly.**
- **You need only connect to this device using a composite Video connection if Component Video and S-Video inputs are unavailable for use. See ["Connecting Video source devices" on page 25](#) for details.**

# Operation

## Starting up the projector

1. Plug the power cord into the projector and into a wall socket. Turn on the wall socket switch (where fitted). Check that the **POWER indicator light** on the projector lights orange after power has been applied.



- **Ask your installation specialist to provide an Earth leakage breaker. When you do not use the projector, be sure to shut down the main power by the breaker.**
- **Please use the original accessories (e.g. power cord) only with the device to avoid possible dangers such as electric shock and fire.**
- **In order to ensure the safety in case of trouble with the projector, use an electrical outlet having an earth leakage breaker to supply the power to the projector. If you do not have such outlet, ask your dealer to install it.**

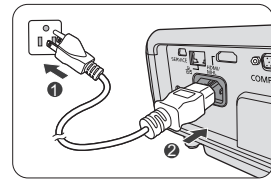

2. Remove the lens cap.

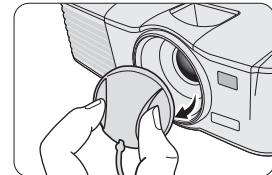

3. Press **POWER** on the projector or remote control to start the projector. The **POWER indicator light** flashes green and stays green when the projector is on.  
The start up procedure takes about 30 seconds. In the later stage of start up, a startup logo is projected.  
(If necessary) Rotate the focus ring to adjust the image clearness.

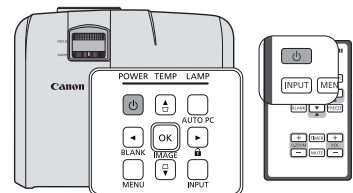

- **If the projector is still hot from previous activity, it will run the cooling fans for approximately 90 seconds before energizing the lamp.**
- **To maintain the lamp life, once you turn the projector on, wait at least 5 minutes before turning it off.**
- **After **POWER** is pressed, the image may flicker before the lamp becomes stable. This is not a product malfunction.**

4. If the projector is activated for the first time, select your OSD language following the on-screen instructions.
5. If you are prompted for a password, press the arrow keys to enter a six-digit password. See "[Utilizing the password function](#)" on [page 32](#) for details.



6. Switch all of the connected equipment on.
7. The projector will start to search for input signals. The current input signal being scanned appears in the upper left corner of the screen. If the projector doesn't detect a valid signal, the message '**No Signal**' will be displayed until an input signal is found.

You can also press **INPUT** on the projector or remote control to select your desired input signal. See "[Switching input signal](#)" on [page 34](#) for details.



- **If the frequency/resolution of the input signal exceeds the projector's operating range, you will see the message 'Out of Range' displayed on a blank screen. Please change to an input signal which is compatible with the projector's resolution or set the input signal to a lower setting. See "[Timing chart](#)" on [page 72](#) for details.**

# Using the menus

The projector is equipped with On-Screen Display (OSD) menus for making various adjustments and settings.

Below is the overview of the OSD menu.

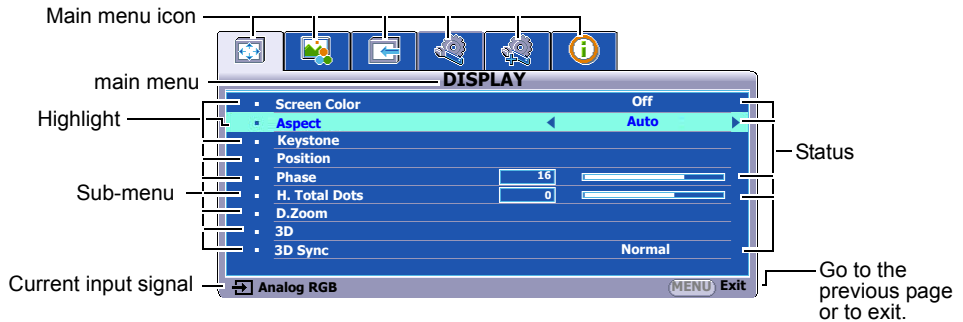

Below is an example about how to set the OSD language.

1. Press **MENU** on the projector or remote control to turn the OSD menu on.
3. Press **▼** to highlight **Language** and press **OK/IMAGE**.

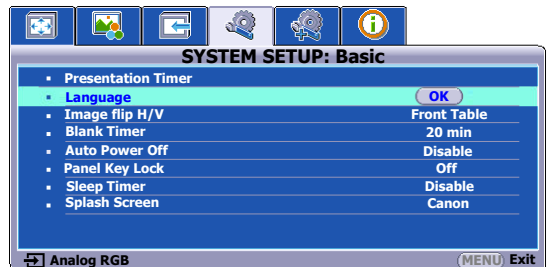

2. Use **◀/▶** to highlight the **SYSTEM SETUP: Basic** menu.

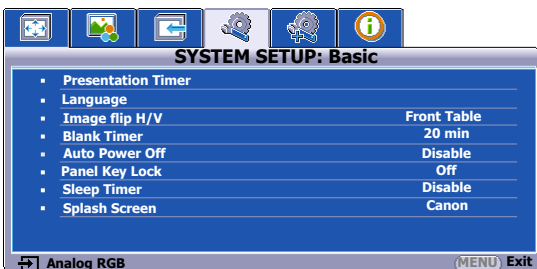

4. Press **◀/▲/▼/▶** to select a preferred language and press **OK/IMAGE**.
5. Press **MENU** on the projector or remote control to leave and save the settings.

## Utilizing the password function

For security purposes and to help prevent unauthorized use, the projector includes an option for setting up password security. The password can be set through the On-Screen Display (OSD) menu. For details of the OSD menu operation, please refer to ["Using the menus" on page 31](#).

☞ **You will be inconvenienced if you activate the power-on lock functionality and subsequently forget the password. Print out this manual (if necessary) and write the password you used in this manual, and keep the manual in a safe place for later recall.**

### Setting a password

☞ **Once a password has been set, the projector cannot be used unless the correct password is entered every time the projector is started.**

1. Open the OSD menu and go to the **SYSTEM SETUP: Advanced > Security Settings** menu. Press **OK/IMAGE**. The **Security Settings** page is displayed.
2. Highlight **Power On Lock** and select **On** by pressing **◀/▶**.
3. As pictured to the right, the four arrow keys (**▲**, **▶**, **▼**, **◀**) respectively represent 4 digits (1, 2, 3, 4). According to the password you desire to set, press the arrow keys to enter six digits for the password.
4. Confirm the new password by re-entering the new password. Once the password is set, the OSD menu returns to the **Security Settings** page.

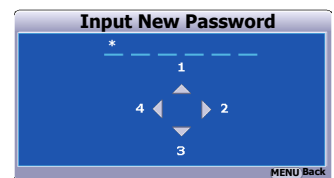

☞ **The digits being input will be displayed as asterisks on-screen. Write your selected password down here in this manual in advance or right after the password is entered so that it is available to you should you ever forget it.**

**Password:** \_ \_ \_ \_ \_

**Keep this number in a safe place.**

5. To leave the OSD menu, press **MENU**.

### If you forget the password

If the password function is activated, you will be asked to enter the six-digit password every time you turn on the projector. If you enter the wrong password, the password error message as pictured to the right is displayed lasting for three seconds, and the message **'INPUT PASSWORD'** follows. You can retry by entering another six-digit password, or if you did not record the password in this manual, and you absolutely do not remember it, you can reset the password function. See ["Resetting the password function" on page 32](#) for details.

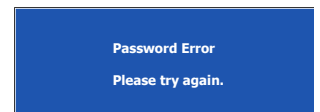

If you enter an incorrect password 5 times in succession, the projector will automatically shut down in a short time.

### Resetting the password function

1. Turn the projector off. See ["Shutting down the projector" on page 44](#) for details.
2. Unplug the power cord.
3. Long press **MENU** and **▶ Right** on the projector until the power cord was plugged.
4. Now the password function has been reset and the **Power On Lock** is **Off**. You can turn on the projector without entering any password. You can also activate the power-on lock functionality as if you were setting the password for the first time. See ["Setting a password" on page 32](#) for details.

### Changing the password

1. Open the OSD menu and go to the **SYSTEM SETUP: Advanced > Security Settings > Change Password** menu.
2. Press **OK/IMAGE**. The message **'INPUT CURRENT PASSWORD'** is displayed.



- 
3. Enter the old password.
    - If the password is correct, another message '**INPUT NEW PASSWORD**' is displayed.
    - If the password is incorrect, the password error message is displayed lasting for three seconds, and the message '**INPUT CURRENT PASSWORD**' is displayed for your retry. You can press **MENU** to cancel the change or try another password.
  4. Enter a new password.

 **The digits being input will be displayed as asterisks on-screen. Write your selected password down here in this manual in advance or right after the password is entered so that it is available to you should you ever forget it.**

**Password:** \_ \_ \_ \_ \_

**Keep this number in a safe place.**

5. Confirm the new password by re-entering the new password.
6. You have successfully assigned a new password to the projector. Remember to enter the new password next time the projector is started.
7. To leave the OSD menu, press **MENU**.

## Disabling the password function

To disable password protection, go back to the **SYSTEM SETUP: Advanced > Security Settings > Power On Lock** menu after opening the OSD menu system. Select **Off** by pressing **◀/▶**. The message '**INPUT PASSWORD**' is displayed. Enter the current password.

- If the password is correct, the OSD menu returns to the **Security Settings** page with '**Off**' shown in the row of **Power On Lock**. You will not have to enter the password next time you turn on the projector.
- If the password is incorrect, the password error message is displayed lasting for three seconds, and the message '**INPUT PASSWORD**' is displayed for your retry. You can press **MENU** to cancel the change or try another password.

 **Though the password function is disabled, you need to keep the old password in hand should you ever need to re-activate the password function by entering the old password.**

## Switching input signal

The projector can be connected to multiple devices at the same time. However, it can only display one full screen at a time.

Be sure the **Auto Search** function in the **INPUT** menu is **On** (which is the default of this projector) if you want the projector to automatically search for the signals.

You can also manually cycle through the available input signals.

1. Press **INPUT** on the projector or remote control. A source selection bar is displayed.
2. Press **▲/▼** until your desired signal is selected and press **OK/IMAGE**.

Once detected, the selected source information will be displayed on the screen for seconds. If there is multiple equipment connected to the projector, repeat steps 1-2 to search for another signal.

- **The brightness level of the projected image will change accordingly when you switch between different input signals. Data (graphic) "PC" presentations using mostly static images are generally brighter than "Video" using mostly moving images (movies).**
- **The input signal type effects the options available for the Image Mode. See ["Selecting a image mode" on page 39](#) for details.**
- **The native display resolution of this projector is in a 4:3 (LV-X320/LV-X310ST)/16:10 (LV-WX320/LV-WX310ST) aspect ratio. For best display picture results, you should select and use an input signal which outputs at this resolution. Any other resolutions will be scaled by the projector depending upon the 'aspect ratio' setting, which may cause some image distortion or loss of picture clarity. See ["Selecting the aspect ratio" on page 37](#) for details.**

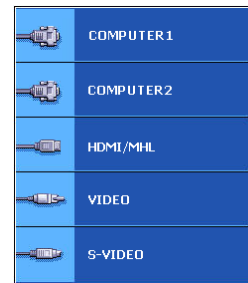
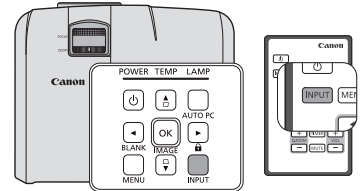

# Adjusting the projected image

## Adjusting the projection angle

The projector is equipped with 1 quick-release adjuster foot and 1 rear adjuster foot. These adjusters change the image height and projection angle. To adjust the projector:

1. Press the quick-release button and lift the front of the projector. Once the image is positioned where you want it, release the quick-release button to lock the foot in position.
2. Screw the rear adjuster foot to fine tune the horizontal angle. To retract the foot, hold up the projector while pressing the quick-release button, then slowly lower the projector. Screw the rear adjuster foot in a reverse direction.

If the projector is not placed on a flat surface or the screen and the projector are not perpendicular to each other, the projected image becomes trapezoidal. To correct this situation, see "[Correcting keystone](#)" on page 36 for details.

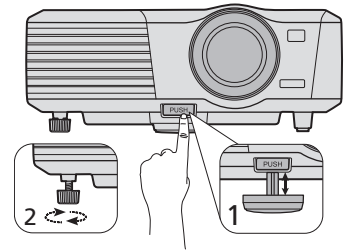

- ⚠️ **Do not look into the lens while the lamp is on. The strong light from the lamp may cause damage to your eyes.**
- **Be careful when you press the adjuster button as it is close to the exhaust vent where hot air comes from.**

## Auto-adjusting the image

In some cases, you may need to optimize the picture quality. To do this, press **AUTO PC** on the projector or remote control. Within 3 seconds, the built-in Intelligent Auto Adjustment function will re-adjust the values of Frequency and Clock to provide the best picture quality.

The current source information will be displayed in the upper left corner of the screen for 3 seconds.

- 👉 **The screen will be blank while AUTO PC is functioning.**
- **This function is only available when a PC signal (analog RGB) is selected.**

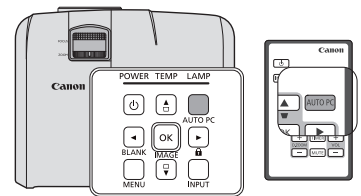

## Fine-tuning the image size and clarity

### LV-WX320/LV-X320

For adjusting the size to your desired, you need to move the product for appropriate projection distance because of small Zoom ratio. Follow the procedure below for the installation and adjustment.

The focus will be off after adjusting the zoom, so be sure to readjust the focus. If the image is very blurry, adjusting the focus to make the image sharp will change the size of the projected image. Repeat the zoom and focus adjustments in alternation as necessary.

In the right figure, (A) Focus Ring, (B) Zoom Ring

1. Adjust Zoom. (using (B) Zoom Ring)
2. For the short distance/large screen, dial the ring fully to Wide end. For the long distance/small screen, dial the ring fully to Tele end.
3. Adjust Focus. (using (A) Focus Ring)
4. Move the product back and forth to adjust the screen size.
5. Adjust Focus again if necessary.

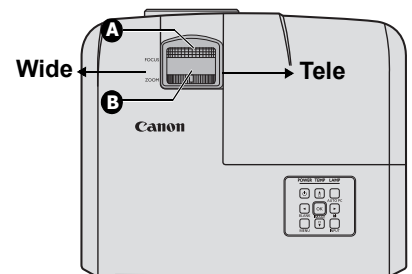

## LV-WX310ST/LV-X310ST

For adjusting the size to your desired, you need to move the product for appropriate projection distance. Follow the procedure below for the installation and adjustment.

The focus will be off after adjusting the projection distance, so be sure to readjust the focus. If the image is very blurry, adjusting the focus to make the image sharp will change the size of the projected image. Adjust the projection distance and focus repeatedly in alternation as necessary.

1. Adjust Focus. (using (C) Focus Ring)
2. Move the product back and forth to adjust the screen size.
3. Adjust Focus again if necessary.

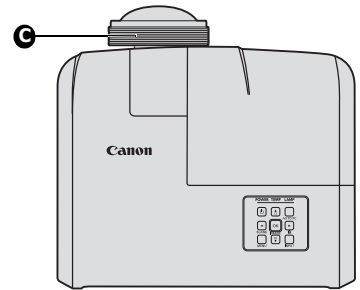

## Correcting keystone

Keystoning refers to the situation where the projected image is noticeably wider at either the top or bottom. It occurs when the projector is not perpendicular to the screen.

To correct this, besides adjusting the height of the projector, you will need to manually correct it following one of these steps.

- Press  $\square/\triangle$  on the projector or remote control to display the Keystone correction page. Press  $\square$  to correct keystone at the top of the image. Press  $\triangle$  to correct keystone at the bottom of the image. Press  $\square$  to correct keystone at the left side of the image. Press  $\triangle$  to correct keystone at the right side of the image.
- Using the OSD menu
  1. Press **MENU** and then press  $\blacktriangle/\blacktriangleright$  until the **DISPLAY** menu is highlighted.
  2. Press  $\blacktriangledown$  to highlight **Keystone** and press **OK/IMAGE**. The **Keystone** correction page is displayed.
  3. Press  $\square$  to correct keystone at the top of the image or press  $\triangle$  to correct keystone at the bottom of the image. Press  $\square$  to correct keystone at the left side of the image. Press  $\triangle$  to correct keystone at the right side of the image.
- **You can correct the vertical and horizontal keystones. However, their adjustment ranges are limited in such correction.**
- **When the keystone adjustment is carried out, the adjustment value is indicated. Note that this value doesn't mean a projection angle.**
- **The allowable range of the adjustment value in the keystone adjustment varies depending on the installation conditions.**
- **Images may not be projected in a shape of a regular rectangle or with its aspect ratio 4:3, depending on the installation conditions of the projector and the screen.**
- **When the keystone adjustment takes effect, the resolution decreases. In addition, stripes may appear or straight lines may bend in images with complicated patterns. They are not due to product malfunctions.**
- **Noise may appear on the screen during the keystone adjustment because of the type of the video signal being projected and the setting values of the keystone adjustment. In such cases, set the keystone adjustment values in the range where the image is displayed without noise.**
- **When the keystone adjustment is carried out, the image may not be displayed correctly because of the type of input signal.**

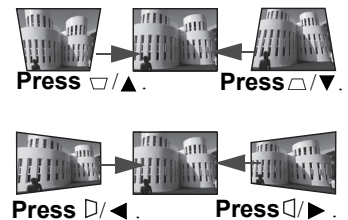
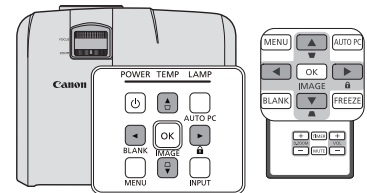

---

## Magnifying and searching for details

If you need to find the details on the projected picture, magnify the picture. Use the direction arrow keys for navigating the picture.

- Using the remote control
  1. Press **D.ZOOM +/-** to display the Zoom bar.
  2. Press **D.ZOOM +** to magnify the center of the picture. Press the key repeatedly until the picture size is suitable for your need.
  3. Use the directional arrows (**▲**, **▼**, **◀**, **▶**) on the projector or remote control to navigate the picture.
  4. To restore the picture to its original size, press **AUTO PC**. You can also press **D.ZOOM -**. When the key is pressed again, the picture is further reduced until it is restored to the original size.

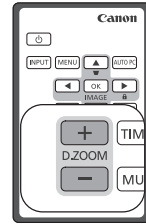

- Using the OSD menu
  1. Press **MENU** and then press **◀/▶** until the **DISPLAY** menu is highlighted.
  2. Press **▼** to highlight **D.ZOOM** and press **OK/IMAGE**. The Zoom bar is displayed.
  3. Repeat steps 2-4 in the section of "[Using the remote control](#)" above. Or if you are using the projector control panel, continue to the following steps.
  4. Press **▲** on the projector repeatedly to magnify the picture to a desired size.
  5. To navigate the picture, press **OK/IMAGE** to switch to the panning mode and press the directional arrows (**▲**, **▼**, **◀**, **▶**) to navigate the picture.
  6. Use the directional arrows (**▲**, **▼**, **◀**, **▶**) on the projector or remote control to navigate the picture.
  7. To reduce size of the picture, press **OK/IMAGE** to switch back to the zoom in/out functionality, and press **AUTO PC** to restore the picture to its original size. You can also press **▼** repeatedly until it is restored to the original size.

 **The picture can only be navigated after the picture is magnified. You can further magnify the picture while searching for details.**

## Selecting the aspect ratio

The 'aspect ratio' is the ratio of the image width to the image height. Most analog TV and computers are in 4:3 ratio, and digital TV and DVDs are usually in 16:9 ratio.











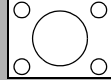
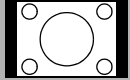
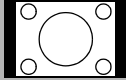

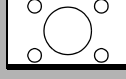
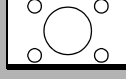

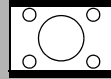
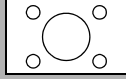
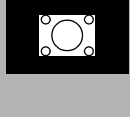

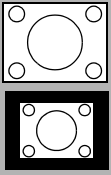
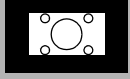
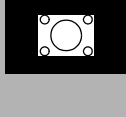

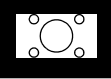
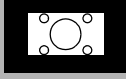
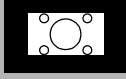

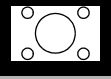
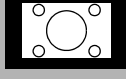

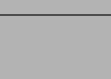

With the advent of digital signal processing, digital display devices like this projector can dynamically stretch and scale the image output to a different aspect than that of the image input signal.

To change the projected image ratio (no matter what aspect the source is):

1. Press **MENU** and then press **◀/▶** until the **DISPLAY** menu is highlighted.
2. Press **▼** to highlight **Aspect**.
3. Press **◀/▶** to select an aspect ratio to suit the format of the video signal and your display requirements.

## About the aspect ratio

 In the pictures below, the black portions are inactive areas and the white portions are active areas. OSD menus can be displayed on those unused black areas.

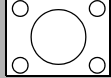
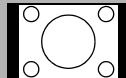
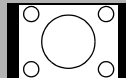
		LV-X320/ LV-X310ST	LV-WX320/ LV-WX310ST
1. <b>Auto:</b> Scales an image proportionally to fit the projector's native resolution in its horizontal width or its vertical height. This is suitable when you want to make most use of the screen without altering the image's aspect ratio.	 →  <b>4:3 picture</b>		
	 →  <b>16:9 picture</b>		
	 →  <b>16:10 picture</b>		
2. <b>Real:</b> The image is projected as its original resolution, and resized to fit within the display area. For input signals with lower resolutions, the projected image will display smaller than if resized to full screen. You could adjust the zoom setting (LV-WX320/LV-X320) or move the projector towards or away from the screen (LV-WX310ST/LV-X310ST) to decrease or increase the image size if necessary. You may also need to refocus the projector after making these adjustments. For input signals with high resolutions, the projected image will be scaled proportionally to fit the projector's native resolution in its horizontal width or its vertical height.	 →  <b>4:3 picture</b>		
	 →  <b>16:9 picture</b>		
	 →  <b>16:10 picture</b>		
3. <b>16:10</b> (LV-WX320/LV-WX310ST only): Scales an image so that it is displayed in the center of the screen with a 16:10 aspect ratio. This is most suitable for images which are already in a 16:10 aspect.	 →  <b>16:9 picture</b>		
	 →  <b>16:10 picture</b>		
4. <b>16:9:</b> Scales an image so that it is displayed in the center of the screen with a 16:9 aspect ratio. This is most suitable for images which are already in a 16:9 aspect, like high definition TV and 16:9 aspect DVD movies, as it displays them without aspect alteration.	 →  <b>16:9 picture</b>		
5. <b>4:3:</b> Scales an image so that it is displayed in the center of the screen with a 4:3 aspect ratio. This is most suitable for 4:3 images like computer monitors, standard definition TV and 4:3 aspect DVD movies, as it displays them without aspect alteration.	 →  <b>4:3 picture</b>		

# Useful functions available during a presentation

## Selecting a image mode

The projector is preset with several predefined image modes so that you can choose one to suit your operating environment and input signal picture type.

To select a operation mode that suits your need, you can follow one of the following steps.

- Press **OK/IMAGE** on the remote control or projector repeatedly until your desired mode is selected.
- Go to the **PICTURE > Image Mode** menu and press **◀/▶** to select a desired mode.

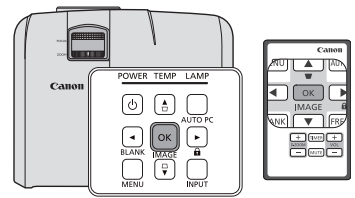

## Image modes for different types of signals

The image modes available for different types of signals are listed below.

1. **Presentation mode:** Suitable for projecting images with a lot of text.
2. **Standard mode:** Suitable for projecting computer screens or colorful images (movies), etc.
3. **sRGB mode:** Suitable for projecting photos from a digital camera that supports sRGB. Compatible with the sRGB standard.
4. **Movie mode:** Suitable for projecting colorful images (movies).
5. **User 1/User 2 mode:** You can save image quality settings that you have made as a custom setting. You can then select the saved settings as an image mode. See "[Setting the User 1/User 2 mode](#)" on [page 39](#) for details.

## Setting the User 1/User 2 mode

There are two user-definable modes if the current available image modes are not suitable for your need. **User 1** (Presentation mode based) is for PC sources, and **User 2** (Standard mode based) is for Video sources.

1. Press **MENU** to open the On-Screen Display (OSD) menu.
2. Go to the **PICTURE > Image Mode** menu.
3. Press **◀/▶** to select **User 1** to **User 2**.
4. Press **▼** to select a sub-menu item to be changed and adjust the value with **◀/▶**. See "[Fine-tuning the image quality in user modes](#)" below for details.
5. The settings will be stored automatically.

## Fine-tuning the image quality in user modes

According to the detected signal type, there are some user-definable functions available when **User 1** or **User 2** mode is selected. You can make adjustments to these functions based on your needs.

### Adjusting Brightness

Highlight **Brightness** in the **PICTURE** menu and adjust the values by pressing **◀/▶** on the projector or remote control.

The higher the value, the brighter the image. And lower the setting, darker the image. Adjust this control so the black areas of the image appear just as black and that detail in the dark areas is visible.



### Adjusting Contrast

Highlight **Contrast** in the **PICTURE** menu and adjust the values by pressing **◀/▶** on the projector or remote control.

The higher the value, the greater the contrast. Use this to set the peak white level after you have previously adjusted the **Brightness** setting to suit your selected input and viewing environment.



### Adjusting Color

Highlight **Color** in the **PICTURE** menu and adjust the values by pressing **◀/▶** on the projector or remote control.

---

Lower setting produces less saturated colors. If the setting is too high, colors on the image will be overpowering, which makes the image unrealistic.

### Adjusting Tint

Highlight **Tint** in the **PICTURE** menu and adjust the values by pressing ◀/▶ on the projector or remote control.

The higher the value, the more reddish the picture becomes. The lower the value, the more greenish the picture becomes.

### Adjusting Sharpness

Highlight **Sharpness** in the **PICTURE** menu and adjust the values by pressing ◀/▶ on the projector or remote control.

The higher the value, the sharper the picture becomes. The lower the value, the softer the picture becomes.

### Adjusting BrilliantColor™

Highlight **BrilliantColor™** in the **PICTURE** menu and select by pressing ◀/▶ on the projector or remote control.

This feature utilizes a new color-processing algorithm and system level enhancements to enable higher brightness while providing truer, more vibrant colors in picture. It enables a greater than 50% brightness increase in mid-tone images, which are common in video and natural scenes, so the projector reproduces images in realistic and true colors. If you prefer images with that quality, select **On**. If you don't need it, select **Off**.

**On** is the default and recommended selection for this projector. When **Off** is selected, the **Color Temperature** function and **6-axis Color Adjust** are not available.

### Selecting a Color Temperature

Highlight **Color Temperature** in the **PICTURE** menu and adjust the values by pressing ◀/▶ on the projector or remote control.

The options available for color temperature\* settings vary according to the signal type selected.

1. **High:** The image becomes tinted with blue. (cold colors).
2. **Middle:** The image uses standard colors.
3. **Low:** The image becomes tinted with red. (warm colors).

#### \*About color temperatures:

There are many different shades that are considered to be "white" for various purposes. One of the common methods of representing white color is known as the "color temperature". A white color with a low color temperature appears to be reddish white. A white color with a high color temperature appears to have more blue in it.

### 6-axis Color Adjust

In most installation situations, color management will not be necessary, such as in classroom, meeting room, or lounge room situations where lights remain on, or where building external windows allow daylight into the room.

Only in permanent installations with controlled lighting levels such as boardrooms, lecture theaters, or home theaters, should color management be considered. Color management provides fine color control adjustment to allow for more accurate color reproduction, should you require it.

Proper color management can only be achieved under controlled and reproducible viewing conditions. You will need to use a colorimeter (color light meter), and provide a set of suitable source images to measure color reproduction. These tools are not provided with the projector, however, your projector supplier should be able to provide you with suitable guidance, or even an experienced professional installer.

The Color Management provides six sets (RGBCMY) of colors to be adjusted. When you select each color, you can independently adjust its range and saturation according to your preference.

If you have purchased a test disc which contains various color test patterns and can be used to test the color presentation on monitors, TVs, projectors, etc. You can project any image from the disc on the screen and enter the **6-axis Color Adjust** menu to make adjustments.



To adjust the settings:

1. Go to the **PICTURE** menu and highlight **6-axis Color Adjust**.
2. Press **OK/IMAGE** and the **6-axis Color Adjust** page is displayed.
3. Highlight **Select Color** and press **◀/▶** to select a color from among Red, Green, Blue, Cyan, Magenta, or Yellow.
4. Press **▼** to highlight **Hue** and press **◀/▶** to select its range. Increase in the range will include colors consisted of more proportions of its two adjacent colors.  
Please refer to the illustration to the right for how the colors relate to each other.  
For example, if you select Red and set its range at 0, only pure red in the projected picture will be selected. Increasing its range will include red close to yellow and red close to magenta.
5. Press **▼** to highlight **Saturation** and adjust its values to your preference by pressing **◀/▶**. Every adjustment made will reflect to the image immediately.  
For example, if you select Red and set its value at 0, only the saturation of pure red will be affected.
6. Press **▼** to highlight **Brightness** and adjust its values to your preference by pressing **◀/▶**. The brightness level of the primary color you select will be affected. Every adjustment made will reflect to the image immediately.
7. Repeat steps 3 to 6 for other color adjustments.
8. Make sure you have made all of the desired adjustments.
9. Press **MENU** to exit and save the settings.

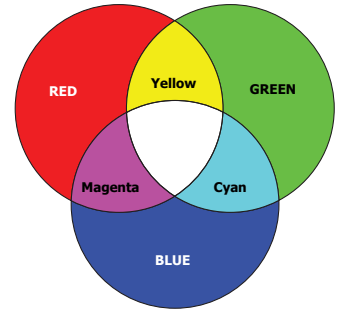

 **Saturation is the amount of that color in a video picture. Lower settings produce less saturated colors; a setting of “0” removes that color from the image entirely. If the saturation is too high, that color will be overpowering and unrealistic.**

## Using Screen Color

In the situation where you are projecting onto a colored surface such as a painted wall which may not be white, the **Screen Color** feature can help correct the projected picture's color to prevent possible color difference between the source and projected pictures.

To use this function, go to the **DISPLAY > Screen Color** menu and press **◀/▶** to select a color which is the closest to the color of the projection surface. There are several recalibrated colors to choose from: **Light Yellow, Pink, Light Green, Blue, and Blackboard**.

## Setting the presentation timer

The presentation timer can indicate the presentation time on the screen to help you achieve better time management when giving presentations. Follow these steps to utilize this function:

1. Go to the **SYSTEM SETUP: Basic > Presentation Timer** menu and press **OK/IMAGE** to display the **Presentation Timer** page.
2. Press **▼** to highlight **Preset Time** and decide the timer period by pressing **◀/▶**. The length of time can be set from 1 to 5 minutes in 1-minute increments and 5 to 240 minutes in 5-minute increments.

☞ **If the timer is already on, the timer will restart whenever the Preset Time is reset.**

3. Press **▼** to highlight **Timer Display** and choose if you want the timer to show up on the screen by pressing **◀/▶**.

Selection	Description
Always	Displays the timer on screen throughout the presentation time.
1 min/2 min/3 min	Displays the timer on screen in the last 1/2/3 minute(s).
Never	Hides the timer throughout the presentation time.

4. Press **▼** to highlight **Position** and set the timer position by pressing **◀/▶**. The reminder position can be chosen from the upper-left, lower-left, upper-right to the lower-right corner of the screen.
5. Press **▼** to highlight **Counting Direction** and select your desired counting direction by pressing **◀/▶**.

Selection	Description
<b>Count Up</b>	Increases from 1 to the preset time.
<b>Count Down</b>	Decrease from the preset time to 1.

6. Press **▼** to highlight **Sound Reminder** and decide if you want to activate sound reminder by pressing **◀/▶**. If you select **On**, a double beep sound will be heard at the last 30 seconds of counting down/up, and a triple beep sound will be produced when the timer is up.
7. To activate the presentation timer, press **▼** and press **◀/▶** to select **On** and press **OK/IMAGE**.
8. A confirmation message is displayed. Highlight **Yes** and press **OK/IMAGE** to confirm. You will see the message **“Timer is On!”** appearing on the screen. The timer starts counting once the timer is turned on.

☞ **If you switch input signal or press AUTO PC when the timer is on, the timer will be stopped.**

**To cancel the timer, perform the following steps.**

1. Go back to the **Presentation Timer** page.
2. Press **▼** and press **◀/▶** to highlight **Off** and press **OK/IMAGE**. A confirmation message is displayed.
3. Highlight **Yes** and press **OK/IMAGE** to confirm. You will see the message **“Timer is Off!”** appearing on the screen.

### Using the TIMER key

**TIMER** is a multi-functional key.

- If the presentation timer is off, pressing this key displays a confirmation message. You can decide whether to activate the timer or not by following the on-screen instruction.
- If the timer is already on, pressing this key displays a confirmation message. You can decide whether to restart, continue or turn off the timer by following the on-screen instruction.

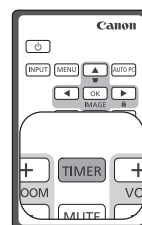

## Hiding the image

In order to draw the audience's full attention to the presenter, you can use **BLANK** on the projector or remote control to hide the screen image. Press any key on the projector or remote control to restore the image. The word '**BLANK**' appears at the lower right corner of the screen while the image is hidden.

You can set the blank time in the **SYSTEM SETUP: Basic > Blank Timer** menu to let the projector return the image automatically after a period of time when there is no action taken on the blank screen.

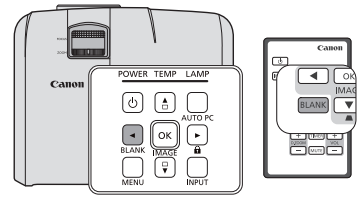

☞ **Once BLANK is pressed, the projector enters Economic mode automatically.**

⚠ **Do not block the projection lens from projecting as this could cause the blocking object to become heated and deformed or even cause a fire.**

## Locking control keys

With the control keys on the projector locked, you can prevent your projector settings from being changed accidentally (by children, for example). When the **Panel Key Lock** is on, no control keys on the projector will operate except **POWER**.

1. Press **▶** **🔒** on the projector or remote control or go to the **SYSTEM SETUP: Basic > Panel Key Lock** menu, and select **On** by pressing **◀/▶** on the projector or remote control.
2. A confirmation message is displayed. Select **Yes** to confirm.

To release panel key lock, press any key of the projector once to display the panel key lock warning. With the warning being displayed, press **▶** **🔒** on the projector or remote control again. (Press and hold the key on the projector for 3 seconds.)

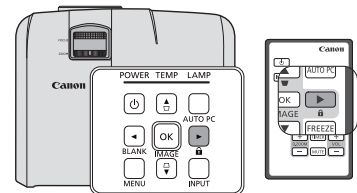

You can also use the remote control to enter the **SYSTEM SETUP: Basic > Panel Key Lock** menu and press **◀/▶** to select **Off**.

- ☞ **Keys on the remote control are still in use when panel key lock is enabled.**
- **If you press **POWER** to turn off the projector without disabling panel key lock, the projector will still be in locked status the next time it is turned on.**

## Freezing the image

Press **FREEZE** on the remote control to freeze the image. The word '**FREEZE**' will be displayed in the upper left corner of the screen. To release the function, press any key on the projector or remote control.

Even if an image is frozen on the screen, the pictures are running on the video or other device. If the connected devices have active audio output, you will still hear the audio even though the image is frozen on screen.

☞ **Do not keep displaying a still picture for an extended period of time, as the afterimages may linger on the screen.**



## Adjusting the sound

The sound adjustments made as below will have an effect on the projector speaker. Be sure you have made a correct connection to the projector audio input. See ["Connection" on page 24](#) for how the audio input is connected.

### Muting the sound

To temporarily turn off the sound, press **MUTE** on the remote control, or:

1. Press **MENU** and then press **◀/▶** until the **SYSTEM SETUP: Advanced** menu is highlighted.
2. Press **▼** to highlight **Audio Settings** and press **OK/IMAGE**. The **Audio Settings** page is displayed.
3. Highlight **Mute** and press **◀/▶** to select **On**.

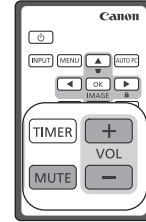

### Adjusting the sound level

To adjust the sound level, press **VOL +/-** on the remote control, or:

1. Repeat steps 1-2 above.
2. Press **▼** to highlight **Volume** and press **◀/▶** to select a desired sound level.

## Personalizing the projector menu display

The On-Screen Display (OSD) menus can be set according to your preferences. The following settings do not affect the projection settings, operation, or performance.

- **Menu Display Time** in the **SYSTEM SETUP: Advanced > Menu Settings** menu sets the length of time the OSD will remain active after your last key press. The time length ranges from 5 to 30 seconds in 5-second increments. Use **◀/▶** to select a suitable time frame.
- **Menu Position** in the **SYSTEM SETUP: Advanced > Menu Settings** menu sets the OSD position in five locations. Use **◀/▶** to select a preferred position.
- **Language** in the **SYSTEM SETUP: Basic** menu sets your familiar language for the OSD menus. See ["Using the menus" on page 31](#) for details.
- **Splash Screen** in the **SYSTEM SETUP: Basic** menu sets a preferred logo screen to be displayed during projector start-up. Use **◀/▶** to select a screen.

## Shutting down the projector

1. Press **⏻ POWER** and a confirmation message displays prompting you.  
If you don't respond in a few seconds, the message will disappear.
2. Press **⏻ POWER** a second time. The **POWER indicator light** flashes orange, the projection lamp shuts down, and the fans will continue to run for approximately 90 seconds to cool down the projector.
3. Once the cooling process finishes, the **POWER indicator light** is a steady orange and fans stop.
4. Disconnect the power cord from the wall socket if the projector will not be used in an extended period of time.

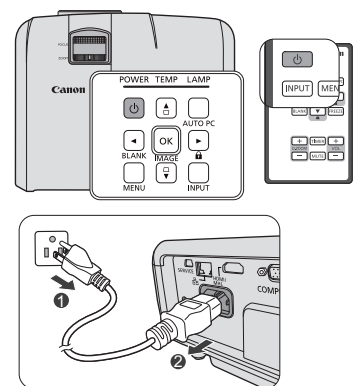

- **To protect the lamp, we suggest you not to operate the projector during the cooling process.**
- **To shorten the cooling time, you can also activate the Quick Cooling function. See ["Quick Cooling" on page 59](#) for details.**
- **Do not unplug the power cord before the projector shutdown sequence is complete or during the 90-second cooling down process.**

- 
- **If the projector is not properly shut down, to protect the lamp, when you attempt to re-start the projector, the fans will run for a few minutes to cool down. Press  $\odot$  POWER again to start the projector after the fans stop and the POWER indicator light turns orange.**

## **Direct power off**

1. The AC power cord can be pulled out during the projector is on. To protect the lamp, wait about 10 minutes before re-starting the projector. When you attempt to re-start the projector, the fans may run for a few minutes to cool down. In such cases, press  $\odot$  **POWER** again to start the projector after the fans stop and the **POWER indicator light** turns orange.
2. To protect the lamp, do not shut down the projector while the **POWER indicator light** is blinking green after the lamp lights up.
3. Before shutting down the projector, be sure to close the menu screen. If you shut down the projector without closing the menu, the setting data of the menu may not be saved.
4. If you shut down the projector while controlling the projector using the network function, the application software such as e-Control™ may fail. In this case, close the application software first. After the connection between the projector and the computer re-establishes, initialize the software again.

# Watching 3D content

---

This projector supports 3D content display using the DLP Link system.

This projector supports 3D image signals in Frame Sequential/Frame Packing/Top-Bottom/**Side-By-Side** format.

You need the following items to project and watch 3D content.

- 3D content capable device. For example, a computer with graphics board and software capable of outputting 3D images
- 3D content
- DLP-Link active electronic shutter 3D glasses (144Hz Compatible)

 **Not all 3D glasses are guaranteed to work correctly.**

## Supported 3D signal

For supported timings in different 3D formats, see "[Timing chart](#)" on page 72 for details.

### To watch 3D content from a computer:

1. Connect the projector to a computer with a computer cable.

 **When connecting the projector to a computer, make sure you switch the computer's output signal so that it is only outputting to the projector (do not use dual mode).**

2. Output a 3D signal from the computer connected to the projector.
3. Turn on the DLP-Link system 3D glasses, and wear them to enjoy the content.
4. Choose an appropriate 3D format for the "3D" setting.
5. If you cannot see 3D objects, change the "3D Sync" setting from the OSD.

### To watch 3D content from an HDMI device:

1. Connect the projector to a computer with an HDMI cable.
2. Output a 3D signal from the HDMI device connected to the projector.
3. Turn on the DLP-Link system 3D glasses, and wear them to enjoy the content.
4. The default setting of the **3D** menu is **Auto** and the projector automatically chooses an appropriate 3D format when detecting 3D contents. If the projector cannot recognize the 3D format, change the "3D" setting and choose a 3D mode.
5. If you cannot see 3D objects, change the "3D Sync" setting from the OSD.

-  • **It may be difficult to view 3D images if the room is too bright. Also, if there are fluorescent lights (50 Hz) in the room, the light may flicker when using 3D glasses. If this happens, turn down or turn off the fluorescent light.**
- You cannot change the image mode when viewing 3D content.

### Cautions when viewing 3D content

- **3D content should not be viewed by people with a history of photosensitive epilepsy, people with heart conditions, pregnant women, the elderly, people with serious illnesses, or people with a history of epileptic seizures.**  
Viewing 3D content could aggravate their pre-existing conditions.
- **Do not view 3D content if you are feeling unwell or are tired.**  
In addition, do not view 3D content if you are sleep deprived or inebriated.
- **If you notice any of the following symptoms, stop viewing the 3D content immediately and wait until the symptoms subside.**
  - If the image appears to be doubled or if the 3D effect is not clear.
  - Stop viewing if you feel your physical condition change, such as if you feel fatigued or unwell.
  - When enjoying 3D content that rotates, rolls, or shakes you may feel as if you are were moving, which can trigger a form of "sea sickness".
- **Viewing 3D content for too long may cause eyestrain. To avoid this, be sure to take regular breaks.**  
Viewing 3D content for too long or viewing them from an angle may cause eyestrain and so on.

- 
- **Children viewing 3D content should always be accompanied by an adult.**  
**Children may not tell you if they are feeling unwell when viewing 3D content, so always be sure to check with the child.**  
**The minimum recommended age for viewing 3D content is six years old.**
  - **Make sure you are at an appropriate distance from the front of the screen when viewing 3D content.**  
**Make sure you are at least three times the height of the screen away from the screen when viewing 3D content, and that your eyes are level with the screen.**
  - **The image source may be reversed.**  
**Check that the settings are correct and that the 3D effect is being correctly applied.**  
**If the image is inversed and the left and right eye images are swapped, the 3D effect does not work, which could cause eye strain or cause you to feel unwell.**

# Supervising and controlling by computer

With a proper LAN cable connection and LAN Control settings, you can operate the projector from a computer using a web browser or PLink™ application when the computer and the projector are connected to the same local area network.

☞ **This projector supports Crestron® software and PLink™.**

An example of connecting the projector to computer.

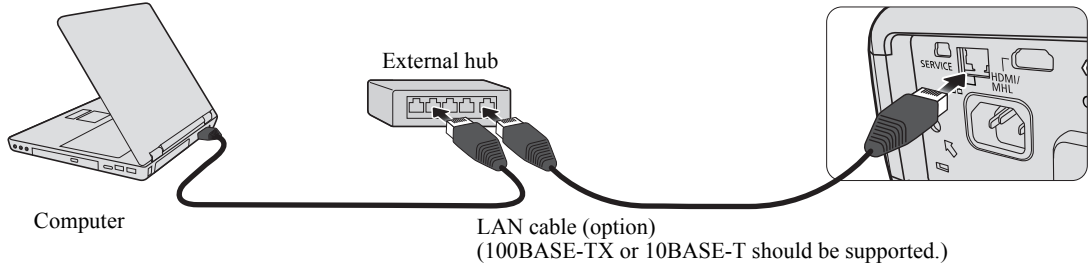

- ☞ • **When using an external hub or router, use a Category 5 straight cable. (A crossed cable can be used with some hubs and routers. See the appropriate documentation for more information.)**
- **Don't touch the metal parts of the LAN connector and LAN cable because static electricity may be discharged from your body, causing damage to the projector.**

## Configuring the LAN Settings

### If you are in a DHCP environment:

1. Make sure the projector and your computer are properly connected to the same local area network.
2. Press **MENU** and then press **◀/▶** until the **SYSTEM SETUP: Advanced** menu is highlighted.
3. Press **▼** to highlight **LAN Settings** and press **OK/IMAGE**. The **LAN Settings** page is displayed.
4. Press **▼** to highlight **DHCP** and press **◀/▶** to select **On**.
5. Press **▼** to highlight **Apply** and press **OK/IMAGE**.
6. Please wait for around 15 - 20 seconds, and then re-enter the **LAN Settings** page.
7. The **Projector IP Address**, **Subnet Mask**, **Default Gateway**, and **DNS Server** settings will be displayed. Note down the IP address displayed in the **Projector IP Address** row.

- ☞ • **If the Projector IP Address still does not appear, contact your network administrator.**
- **If the LAN cables are not properly connected, the Projector IP Address, Subnet Mask, Default Gateway, and DNS Server settings will display 0.0.0.0. Make sure the LAN cables are properly connected and perform the above procedures again.**

### If you are in a non-DHCP environment:

1. Repeat steps 1-3 above.
2. Press **▼** to highlight **DHCP** and press **◀/▶** to select **Off**.
3. Contact your network administrator for information on the **Projector IP Address**, **Subnet Mask**, **Default Gateway**, and **DNS Server** settings.
4. Press **▼** to select the item you want to modify and press **OK/IMAGE**.
5. Press **◀/▶** to move the cursor and then press **▲/▼** to enter the value.
6. To save the setting, press **OK/IMAGE**. If you do not want to save the setting, press **MENU**.
7. Press **▼** to highlight **Apply** and press **OK/IMAGE**.

- ☞ **If the LAN cables are not properly connected, the Projector IP Address, Subnet Mask, Default Gateway, and DNS Server settings will display 0.0.0.0. Make sure the LAN cables are properly connected and perform the above procedures again.**



# Controlling the projector remotely through a web browser (e-Control™)

Once you have the correct IP address for the projector and the projector is on or in standby state, you can use any computer that is on the same local area network to control the projector.

When using this function, Adobe Flash Player has to be installed in your computer. Please download Adobe Flash Player from the website of Adobe Systems Incorporated.

1. Enter the IP address of the projector in the address bar of your browser and press enter. (for example, <http://192.168.0.146/>)



2. The remote network operation page is displayed. This page allows you to operate the projector as if you were using the remote control or control panel on the projector.

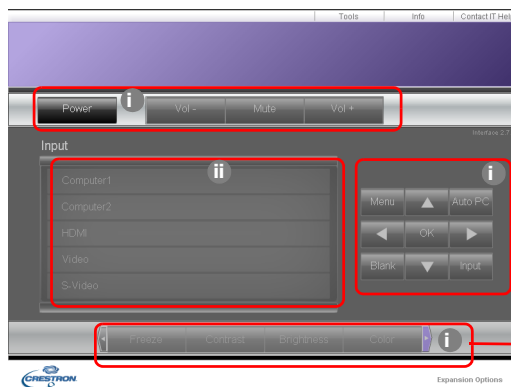

Press ◀/▶ to reveal more buttons.

- i. These buttons function the same as the ones on the OSD menus or remote control. See "2. PICTURE menu" on page 58 and "Remote control: LV-RC08" on page 16 for details.
- ii. To switch input source, click on your desired source.

 **When you use the projector control panel or remote control to change the OSD menu settings, it may take a while for the web browser to synchronize these changes with the projector.**

3. The Tools page allows you to manage the projector, configure the LAN control settings and secure access of remote network operation on this projector.

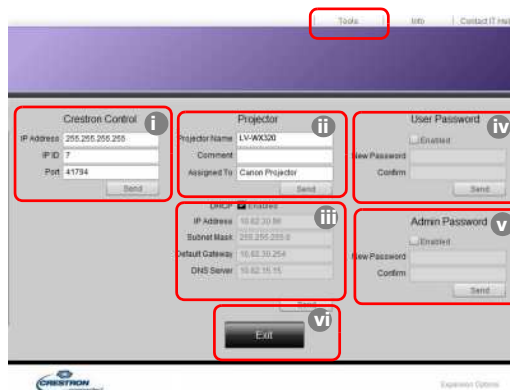

- i. When using the Crestron Control System, please refer to the user manual of Crestron Control system for setup information.
- ii. You can name the projector, keep track of its location and the person in charge of it. This column allows a maximum of 22 single-byte characters.
- iii. You can adjust the **LAN Settings**.

- iv. Once set, access to the remote network operation page on this projector has been password-protected. To enable this function, check the box in front of "Enable" and type in your desired password in the New Password column and confirm the new password by re-entering the new password at the Confirm column. To disable password protection, uncheck the box.
- v. Once set, access to the Tools page has been password-protected. Refer to step iv for how to use the password function.
- vi. Press **Exit** to go back to the remote network operation page.



- **After making the adjustments, press the Send button and the data will be saved in the projector.**
  - **Once the password is set, the Log Out button will display beside the Tools button.**
  - **Write down your selected password in advance or right after the password is entered so that it is available to you should you ever forget it.**
  - **If you did not write down your password, and you absolutely do not remember it you can reset the password by following procedure.**
    - Open log in screen of e-Control. by your web browser.
    - Long press MENU and ► Right on the projector for 3 seconds.
    - Now the password has been reset.
  - **The software is available in English language.**
  - **When DHCP is turned on, there is a possibility of stopping the webpage connection. If this happens, please check the new IP address of the projector and enter the new address to connect again.**
4. The Info page displays the information and status of this projector.

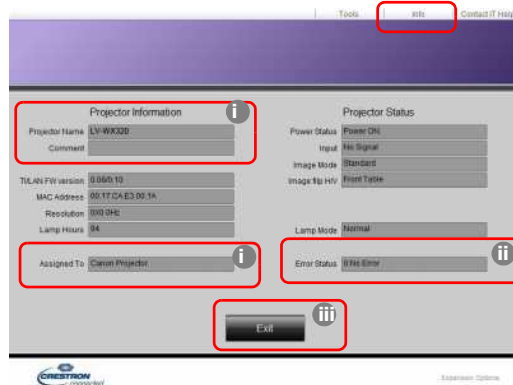

- i. The information you entered in the Tools page will display here and these columns are empty when you use e-Control™ for the first time.
- ii. When the projector is in abnormal conditions, the following information will display.

☞ When the projector is in normal conditions or in any abnormal conditions other than the ones mentioned below, the Error Status column will be "0:No Error".

Error Status	Description
3: Lamp fail	The lamp fails to ignite or turns off during operation.
3: Over Temp	The projector temperature is too high or cannot be detected.
3: Fan Lock	The fan rotation speed cannot be set or detected.
3: Over Lamp Usage Time	The lamp is still in use after the lamp warning messages display.

(3 = Error)

- iii. Press **Exit** to go back to the remote network operation page.
5. After pressing the button 'Contact IT Help', the HELP DESK window will appear at the upper right corner. You will be able to deliver messages to RoomView™ software which is connected to the same local area network.



For more information, visit <http://www.crestron.com> & [www.crestron.com/getroomview](http://www.crestron.com/getroomview).

## Controlling the projector using PJLink™ application

This projector supports standard protocol PJLink™ for projector control and you can control and monitor projector's operations using the same application among projectors of different models and different manufacturers.

### About PJLink™

- To use PJLink™ function, the PJLink™ application software is required.
- For the specifications of PJLink™, access to the Web site of Japan Business Machine and Information System Industries Association (JBMIA). (<http://pjlink.jbmia.or.jp/english>)
- This projector is fully compliant to the specifications of JBMIA PJLink™ Class 1. It supports all the commands defined by PJLink™ Class 1, and the compliance has been verified with the PJLink™ standard specifications Version 1.4.

### Utilizing the password function

To prevent unauthorized connection to the projector via PJLink™ application, the projector includes an option for setting up password security. To set the password:

1. Open the OSD menu and go to the **SYSTEM SETUP: Advanced > LAN Settings** menu. Press **OK/IMAGE**. The **LAN Settings** page is displayed.
2. Highlight **PJLink Certification** and select **On** by pressing **◀/▶**. The default password is "admin".
3. Press **▼** to highlight **Change PJLink Password** and press **OK/IMAGE**.
4. Enter the current password. Press **▶**, **◀** to select the digit and press **▲**, **▼** to select from 0-9, A-Z, a-z or symbols. Press **OK/IMAGE** to confirm.
5. Enter the new password and Press **OK/IMAGE** to confirm.

☞ If you forget the password, please use the password "projectorcontroller".

## PJLink™ supported commands

The table below shows commands to control the projector using the PJLink™ protocol.

Command	Description	Remark (Parameter)
POWR	Power control	0 = Power off 1 = Power on
POWR?	Inquiry about the power state	0 = Standby 1 = Power on 2 = Cooling down 3 = Warming up
INPT	Input switching	11 = COMPUTER1 12 = COMPUTER2 21 = VIDEO 22 = S-VIDEO 31 = HDMI
INPT?	Inquiry about input switching	
AVMT	Mute control	10 = BLANK disable 11 = BLANK enable 20 = Audio mute disable 21 = Audio mute enable 30 = BLANK and audio mute disable 31 = BLANK and audio mute enable
AVMT?	Inquiry about the mute state	
ERST?	Inquiry about the error state	1st byte: Fan error, 0 or 2 2nd byte: Lamp error, 0 or 2 3rd byte: Temperature error, 0 or 2 4th byte: Always 0 5th byte: Always 0 6th byte: Other errors, 0 or 2 * 0 or 2 mean as follows: 0 = No error detected, 2 = Error
LAMP?	Inquiry about the lamp state	1st value (1 to 4 digits): Cumulative lamp operating time (This item shows a lamp operating time (hour) calculated based on that Lamp Mode is Economic.) 2nd value: 0 = Lamp off, 1 = Lamp on
INST?	Inquiry about the available inputs	The following value is returned. "11 12 21 22 31"
NAME?	Inquiry about the projector name	The command responds with the projector name specified in the Tools page.
INF1?	Inquiry about the manufacturer name	"Canon" is returned.
INF2?	Inquiry about the model name	"LV-WX320", "LV-X320", "LV-WX310ST" or "LV-X310ST" is returned.
INF0?	Inquiry about other information	DMD resolution is returned.
CLSS?	Inquiry about the class information	"1" is returned.

- The PJLink "INPT?" will be replied only when the source is displayed on screen. When there is no signal, only "ERR3 Time!" will be answered.
- The above-mentioned control may not be performed correctly or the monitoring data may not be obtained correctly in the following conditions:

- During standby
- During input source switching
- During command processing
- During AUTO PC execution
- Before the splash screen disappears after the power is turned on.
- Use 1 computer to control/monitor 1 projector.
- For how to control/monitor using PJLink™, see the operation manual of the PJLink™ application you use.
- When you monitor the projector's operating state using this function by issuing inquiry commands successively, issue an inquiry command after receiving the response to the previous inquiry command from the projector.

## Using the Network Function when the projector is in standby mode

When the **Standby LAN** in the **SYSTEM SETUP: Advanced > LAN Settings** menu is activated, the projector is able to provide the network function when it is in standby mode.

## Glossary

For more detail of the glossary below, refer to the technical book that is commercially available.

Term	Description
DHCP	Abbreviation for Dynamic Host Configuration Protocol. This protocol automatically assigns IP Address to networked devices.
IP Address	Numerical address to identify networked computers.
Subnet Mask	A numeric value to define the number of bits used for a network address of a divided network (or subnet) in an IP Address.
Default Gateway	A server (or router) to communicate across networks (subnets) that are divided by Subnet Mask.

# Menu operation

## Menu system

Please note that the on-screen display (OSD) menus vary according to the signal type selected.

Main menu	Sub-menu	Options	
1. DISPLAY	Screen Color	Off*/Light Yellow/Pink/Light Green/Blue/Blackboard	
	Aspect	Auto*/Real/16:10 (LV-WX320/LV-WX310ST)/4:3/16:9	
	Keystone		
	Position		
	Phase		
	H. Total Dots		
	D.Zoom		
	3D	Auto*/Frame Sequential/ Frame Packing/Top-Bottom/ Side-By-Side	
	3D Sync	Normal*/Invert	
	2. PICTURE	Image Mode	Presentation/Standard*/sRGB/ Movie/User 1/User 2
Brightness			
Contrast			
Color			
Tint			
Sharpness			
BrilliantColor™		On*/Off	
Color Temperature		High/Middle*/Low	
6-axis Color Adjust		Select Color	R*/G/B/C/M/Y
		Hue	
	Saturation		
3. INPUT	Brightness		
	Auto Search	On*/Off	

 \* Indicates an item that is factory-set (after reset).

Main menu	Sub-menu	Options		
4. SYSTEM SETUP: Basic	Presentation Timer	Preset Time	1~240 minutes	
		Timer Display	Always*/1 min/2 min/3 min/Never	
		Position	Top-Left*/Bottom-Left/Top-Right/ Bottom-Right	
		Counting Direction	Count Down*/Count Up	
		Sound Reminder	On*/Off	
			On/Off*	
		Language	English*/ Français / Deutsch Italiano / Español / Русский 繁體中文 / 简体中文 / 日本語 / 한국어 Svenska / Türkçe / Čeština / Português العربية / Suomi / Magyar / العربية / Nederlands Română / Norsk / Dansk Polski / Қазақский / Tiếng Việt	
		Image flip H/V	Front Table*/Rear Table/ Front Ceiling/Rear Ceiling	
		Auto Power Off	Disable/5 min/10 min/15 min/ 20 min*/25 min/30 min	
		Blank Timer	Disable*/5 min/10 min/15 min/ 20 min/25 min/30 min	
		Panel Key Lock	Off*/On	
		Sleep Timer	Disable*/30 min/1 hr/2 hr/3 hr/4 hr/ 8 hr/12 hr	
		Splash Screen	Black/Blue/Canon*	
	5. SYSTEM SETUP: Advanced		Quick Cooling	On/Off*
		High Altitude Mode	On/Off*	
		Audio Settings	Mute	On/Off*
			Volume	
		Menu Settings	Menu Display Time	5 sec/10 sec/15 sec*/20 sec/ 25 sec/30 sec
			Menu Position	Center*/Top-Left/Top-Right/ Bottom-Right/Bottom-Left
		Lamp Settings	Lamp Mode	Normal*/Economic
			Reset Lamp Time	
			Lamp Time	

 \* Indicates an item that is factory-set (after reset).

Main menu	Sub-menu	Options	
<b>5. SYSTEM SETUP: Advanced</b>	<b>Security Settings</b>	<b>Change Password</b>	
		<b>Power On Lock</b> <b>On/Off*</b>	
	<b>Closed Caption Settings</b>	<b>Closed Caption</b> <b>On/Off*</b>	
		<b>Caption Channel</b> <b>CC1*/CC2/CC3/CC4</b>	
	<b>LAN Settings</b>	<b>Standby LAN</b> <b>Off*/On</b>	
		<b>PJLink Certification</b> <b>Off*/On</b>	
		<b>Change PJLink Password</b>	
		<b>DHCP</b> <b>On*/Off</b>	
		<b>Projector IP Address</b>	
		<b>Subnet Mask</b>	
		<b>Default Gateway</b>	
		<b>DNS Server</b>	
		<b>Apply</b>	
		<b>Reset All Settings</b>	
	<b>6. INFORMATION</b>	<b>Current System Status</b>	<b>Input</b>
			<b>Image Mode</b>
			<b>Color Format</b>
<b>Resolution</b>			
<b>Lamp Time</b>			

- \* Indicates an item that is factory-set (after reset).
- The menu items are available when the projector detects at least one valid signal. If there is no equipment connected to the projector or no signal detected, limited menu items are accessible.







## Description of each menu

FUNCTION	DESCRIPTION
<b>Screen Color</b>	Corrects the projected picture's color when the projection surface is not white. See <a href="#">"Using Screen Color" on page 41</a> for details.
<b>Aspect</b>	There are several options to set the image's aspect ratio depending on your input signal source. See <a href="#">"Selecting the aspect ratio" on page 37</a> for details.
<b>Keystone</b>	Corrects any keystone of the image. See <a href="#">"Correcting keystone" on page 36</a> for details.
<b>Position</b>	Displays the position adjustment page. To move the projected image, use the directional arrow keys. The values shown on the lower position of the page change with every key press you made until they reach their maximum or minimum.
<b>Phase</b>	Adjusts the clock phase to reduce image distortion. 
<b>H. Total Dots</b>	Adjusts the horizontal width of the image.
<b>D.Zoom</b>	Magnifies or reduces the projected image. See <a href="#">"Magnifying and searching for details" on page 37</a> for details.
<b>3D</b>	This projector features a 3D function which enables you to enjoy 3D movies, videos, and sporting events in a more realistic way by presenting the depth of the images. You need to wear a pair of 3D glasses to view the 3D images. See <a href="#">"Watching 3D content" on page 46</a> for details.
<b>3D Sync</b>	When you discover the inversion of the image depth, enable this function to correct the problem.

1. DISPLAY menu

FUNCTION	DESCRIPTION
<b>Image Mode</b>	Pre-defined image modes are provided so you can optimize your projector image set-up to suit your program type. See <a href="#">"Selecting a image mode" on page 39</a> for details.
<b>Brightness</b>	Adjusts the brightness of the image. See <a href="#">"Adjusting Brightness" on page 39</a> for details.
<b>Contrast</b>	Adjusts the degree of difference between dark and light in the image. See <a href="#">"Adjusting Contrast" on page 39</a> for details.
<b>2. PICTURE menu</b>	<b>Color</b> Adjusts the color saturation level -- the amount of each color in a video image. See <a href="#">"Adjusting Color" on page 39</a> for details.
	<b>Tint</b> Adjusts the red and green color tones of the image. See <a href="#">"Adjusting Tint" on page 40</a> for details.  <b>The function is only available when Video or S-Video with NTSC system is selected.</b>
	<b>Sharpness</b> Adjusts the image to make it look sharper or softer. See <a href="#">"Adjusting Sharpness" on page 40</a> for details.
	<b>BrilliantColor™</b> Adjusts white peaking while maintaining correct color presentation. See <a href="#">"Adjusting BrilliantColor™" on page 40</a> for details.
	<b>Color Temperature</b> See <a href="#">"Selecting a Color Temperature" on page 40</a> for details.
<b>6-axis Color Adjust</b>	See <a href="#">"6-axis Color Adjust" on page 40</a> for details.
<b>3. INPUT menu</b>	<b>Auto Search</b> See <a href="#">"Switching input signal" on page 34</a> for details.

	FUNCTION	DESCRIPTION
4. SYSTEM SETUP: Basic menu	<b>Presentation Timer</b>	Reminds the presenter to finish the presentation within a certain time frame. See <a href="#">"Setting the presentation timer" on page 42</a> for details.
	<b>Language</b>	Sets the language for the On-Screen Display (OSD) menus. See <a href="#">"Using the menus" on page 31</a> for details.
	<b>Image flip H/V</b>	See <a href="#">"Choosing a location" on page 19</a> for details.
	<b>Auto Power Off</b>	Allows the projector to turn off automatically if no input signal is detected and no operation is made by user after a set period of time. See <a href="#">"Setting Auto Power Off" on page 62</a> for details.
	<b>Blank Timer</b>	Sets the image blank time when the Blank feature is activated, once elapsed the image will return to the screen. See <a href="#">"Hiding the image" on page 43</a> for details.
	<b>Panel Key Lock</b>	Disables or enables all panel key functions except  <b>POWER</b> on the projector and keys on the remote control. See <a href="#">"Locking control keys" on page 43</a> for details.
	<b>Sleep Timer</b>	Sets the auto-shutdown timer. The timer can be set to a value between 30 minutes and 12 hours.
	<b>Splash Screen</b>	Allows you to select which logo screen will be displayed during projector start-up. See <a href="#">"Personalizing the projector menu display" on page 44</a> for details.
5. SYSTEM SETUP: Advanced menu	<b>Quick Cooling</b>	Selecting <b>On</b> enables the function and the projector cooling time will be shortened to a few seconds.  <b>If you attempt to restart the projector right after the quick cooling process, it may not be turned on successfully and will rerun its cooling fans.</b>
	<b>Audio Settings</b>	See <a href="#">"Adjusting the sound" on page 44</a> for details.
	<b>Menu Settings</b>	See <a href="#">"Personalizing the projector menu display" on page 44</a> for details.
	<b>Lamp Settings</b>	<b>Lamp Mode</b> See <a href="#">"Setting Lamp Mode as Economic" on page 62</a> for details. <b>Reset Lamp Time</b> See <a href="#">"Resetting the lamp timer" on page 66</a> for details. <b>Lamp Time</b> See <a href="#">"Getting to know the lamp hour" on page 62</a> for details on how the total lamp hour is calculated.
	<b>Security Settings</b>	See <a href="#">"Utilizing the password function" on page 32</a> for details.

FUNCTION	DESCRIPTION
<b>5. SYSTEM SETUP: Advanced menu</b>	<p><b>Closed Caption Settings</b></p> <p>Activates the function by selecting <b>On</b> when the selected input signal carries closed captions.</p> <ul style="list-style-type: none"> <li>• Captions: An on-screen display of the dialogue, narration, and sound effects of TV programs and videos that are closed captioned (usually marked as "CC" in TV listings).</li> </ul> <p> <b>When the projector displays OSD or any dialog, captions are not displayed at the same time.</b></p> <p><b>Caption Channel</b></p> <p>Selects a preferred closed captioning mode. To view captions, select <b>CC1</b>, <b>CC2</b>, <b>CC3</b>, or <b>CC4</b> (<b>CC1</b> displays captions in the primary language in your area).</p>
	<p><b>LAN Settings</b></p> <p>If you are using a LAN cable for connection, see <a href="#">"Supervising and controlling by computer" on page 48</a> for details.</p> <p>If you are using the PJLink™ application, see <a href="#">"Controlling the projector using PJLink™ application" on page 51</a> for details.</p>
	<p><b>Reset All Settings</b></p> <p>Returns all settings to the factory preset values.</p> <p> <b>The following settings will still remain: User 1, User 2, Language, Image flip H/V, High Altitude Mode, Security Settings, LAN Settings, "Tools" menu in web UI, PJLink Password.</b></p>
<b>6. INFORMATION menu</b>	<p><b>Input</b></p> <p>Shows the current signal source.</p> <p><b>Image Mode</b></p> <p>Shows the selected mode in the <b>PICTURE</b> menu.</p> <p><b>Resolution</b></p> <p>Shows the native resolution of the input signal.</p> <p><b>Color Format</b></p> <p>Shows input system format.</p> <p><b>Lamp Time</b></p> <p>Displays the number of hours the lamp has been used.</p>

# Maintenance

---

## Care of the projector

Your projector needs maintenance from time to time, depending on the environmental circumstances, and should be done by authorized service technicians only. Contact your dealer for instructions.

The only thing you can do yourselves on a regular basis is to keep the lens and cabinet clean.

Never remove any parts of the projector except the lamp. Contact your dealer if other parts need replacing.

### Cleaning the lens

Clean the lens whenever you notice dirt or dust on the surface.

- Use a canister of compressed air to remove dust.
- If there is dirt or smears, use lens-cleaning paper or moisten a soft cloth with lens cleaner and gently wipe the lens surface.
- Never rub the lens with abrasive materials.

### Cleaning the projector case

Before you clean the case, turn the projector off using the proper shutdown procedure as described in "[Shutting down the projector](#)" on page 44 and unplug the power cord.

- To remove dirt or dust, wipe the case with a soft, lint-free cloth.
- To remove stubborn dirt or stains, moisten a soft cloth with water and a neutral pH detergent. Then wipe the case.
- **Never use wax, alcohol, benzene, thinner or other chemical detergents. These can damage the case.**
- **Flammable substances may ignite causing fire or breakdown while the lamp is illuminating.**

### Storing the projector

If you need to store the projector for an extended time, please follow the instructions below:

- Make sure the temperature and humidity of the storage area are within the recommended range for the projector. Please refer to "[Specifications](#)" on page 69 or consult your dealer about the range.
- Retract the adjuster feet.
- Remove the battery from the remote control.
- Pack the projector in its original packing or equivalent.

### Transporting the projector

It is recommended that you ship the projector with its original packing or equivalent.

# Lamp information

---

## Getting to know the lamp hour

When the projector is in operation, the duration (in hours) of lamp usage is automatically calculated by the built-in timer. The method of calculating the equivalent lamp hour is as follows:

Total Lamp Hour = (hours used in **Normal** mode) + 2/3\*(hours used in **Economic** mode)

 See "**Setting Lamp Mode as Economic**" below for more information on **Economic** mode.

To obtain the lamp hour information:

1. Press **MENU** and then press **◀/▶** until the **SYSTEM SETUP: Advanced** menu is highlighted.
2. Press **▼** to highlight **Lamp Settings** and press **OK/IMAGE**. The **Lamp Settings** page is displayed.
3. You will see the **Lamp Time** information appearing on the menu.
4. To leave the menu, press **MENU**.

You can also get the lamp hour information on the **INFORMATION** menu.

## Extending lamp life

Lamps should be replaced about every 4,000 (used in **Normal** Mode)-6,000 (Used in **Economic** Mode) hours. Note that there is no guarantee how long lamps will last.

To keep the lamp life as long as possible, you can do the following settings via the OSD menu.

### Setting Lamp Mode as Economic

Using **Economic** mode reduces system noise and power consumption by approximately 20%. If the **Economic** mode is selected, the light output will be reduced and result in darker projected pictures.

Setting the projector in **Economic** mode also extends the lamp operation life. To set **Economic** mode, go into the **SYSTEM SETUP: Advanced > Lamp Settings > Lamp Mode** menu and press **◀/▶**.

-  • **When this mode is switched, the projected images may flicker.**
- **If this mode is frequently switched, the lamp may be deteriorated.**

### Setting Auto Power Off

This function allows the projector to turn off automatically if no input source is detected and no operation is made by user after a set period of time to prevent unnecessary waste of lamp life.

To set **Auto Power Off**, go into the **SYSTEM SETUP: Basic > Auto Power Off** menu and press **◀/▶**. The time period can be set from 5 to 30 minutes in 5-minute increments. If the preset time lengths are not suitable for your presentation, select **Disable**. The projector will not automatically shut down in a certain time period.

## Timing of replacing the lamp

When the lamp indicator lights up red or a message appears suggesting it is time to replace the lamp, please install a new lamp or consult your dealer. An old lamp may cause a malfunction in the projector and in some instances the lamp may explode.

**⚠ The LAMP indicator light and TEMPerature indicator light will light up if the lamp becomes too hot. Turn the power off and let the projector cool for 45 minutes. If the Lamp or LAMP indicator light still lights up after turning the power back on, please contact your dealer. See "Indicators" on page 67 for details.**

The following lamp warning displays will remind you to change the lamp.

Status	Message
The lamp has been in operation for 3500 hours. Install a new lamp for optimal performance. If the projector is normally run with <b>Economic</b> selected (See " <a href="#">Setting Lamp Mode as Economic</a> " on page 62), you may continue to operate the projector until the 3950 hour lamp warning appears.	<p><b>Notice</b></p> <p>Order Replacement Lamp Lamp &gt; 3500 Hours</p> <p>OK</p>
The lamp has been in operation for 3950 hours. A new lamp should be fitted to avoid the inconvenience when the projector runs out of lamp time.	<p><b>Notice</b></p> <p>Replace Lamp Soon Lamp &gt; 3950 Hours</p> <p>OK</p>
The lamp has been in operation for 4000 hours. It is strongly recommended that you replace the lamp at this age. <b>⚠ The lamp is a consumable item. The lamp brightness diminishes with use. This is normal lamp behavior. You can replace the lamp whenever you notice that the brightness level has significantly diminished. If the lamp is not replaced beforehand, it must be replaced after 4000 hours usage.</b>	<p><b>Notice</b></p> <p>Replace Lamp Now Lamp &gt; 4000 Hours</p> <p>OK</p>
The lamp <b>MUST</b> be replaced before the projector will operate normally.	<p><b>WARNING</b></p> <p>Out of Lamp Usage Time Replace lamp (Refer to user manual) Then reset lamp timer</p> <p>OK</p>

## Replacing the lamp

Spare lamp: LV-LP38 (LV-X320/LV-X310ST)/  
LV-LP40 (LV-WX320/LV-WX310ST)

- ⚠ • Be sure to replace the lamp with a new lamp separately sold that is exclusive to this projector. Contact your dealer for purchase of the lamp.
  - To reduce the risk of electrical shock, always turn the projector off and disconnect the power cord before changing the lamp.
  - To reduce the risk of severe burns, allow the projector to cool for at least 45 minutes before replacing the lamp.
  - To reduce the risk of injuries to fingers and damage to internal components, use caution when removing lamp glass that has shattered into sharp pieces. To reduce the risk of injuries to fingers and/or compromising image quality by touching the lens, do not touch the empty lamp compartment when the lamp is removed.
  - Be sure to install the lamp securely. When the lamp isn't installed properly, it won't illuminate. Improper installation may also result in fire.
  - If the lamp should break, never shake the lamp box or hold it in front of your face after removing it. The glass fragments may fall out and cause injury to your eyes.
  - In the event that the high-pressure mercury lamp exploded, glass fragments may have been scattered inside the projector. Ask your dealer to replace the lamp and to inspect the inside of the projector. When you clean or replace the lamp by yourself, be sure to hold the handle of the lamp. You may get injured by glass fragments.
  - Contact your dealer when replacing the lamp unit with the projector mounted to the ceiling.
  - Don't remove the lamp for any purpose other than replacement. Unnecessary removal of the lamp may result in a breakdown.
  - This projector uses a high-pressure mercury lamp as the light source. The high-pressure mercury lamp may explode or fail to illuminate permanently because of an impact, scratch, or deterioration through use. The period of time until explosion or permanent failure to illuminate varies considerably from lamp to lamp, depending on operation conditions. Therefore, the lamp may explode soon after the start of use.
  - The possibility of explosion of the lamp increases if you use it beyond its replacement period. When the instruction of lamp replacement appears, replace it with a new one immediately even if the lamp is still lighting normally.
  - When the high-pressure mercury lamp explodes, glass fragments will scatter inside or outside the lamp box and the gas charged inside the lamp will diffuse inside or outside the projector. The gas inside the lamp contains mercury. Be careful not to breathe it or avoid it from entering your eye or mouth. If you should breathe it or if it should enter your eye or mouth, see a doctor immediately.
  - This lamp contains mercury. Consult your local hazardous waste regulations to dispose of this lamp in a proper manner.
  - Be sure to use the lamp dedicated to this projector, LV-LP38 (LV-X320/LV-X310ST)/LV-LP40 (LV-WX320/LV-WX310ST). Use of other lamps may cause a failure of the projector.
1. Turn the power off and disconnect the projector from the wall socket. If the lamp is hot, avoid burns by waiting for approximately 45 minutes until the lamp has cooled.
  2. Unscrew the screws on the lamp cover.

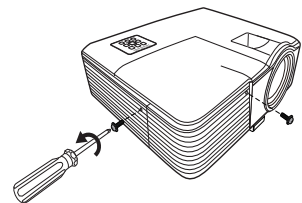



3. Remove the lamp cover from the projector.

①, ②

Pull up the lamp cover, pushing up the allow parts of the front panel.

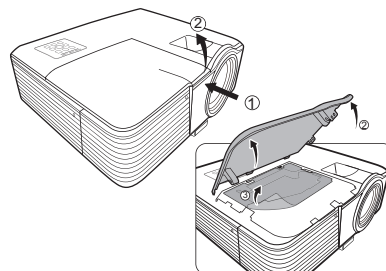

- **Do not turn the power on with the lamp cover removed.**
- **Do not insert your fingers between the lamp and the projector. The sharp edges inside the projector may cause injuries.**

4. Confirm a position of the lamp protection film to put a new film on the same position later. Remove and dispose of the lamp protection film. ③
5. Loosen the screw that secures the lamp.

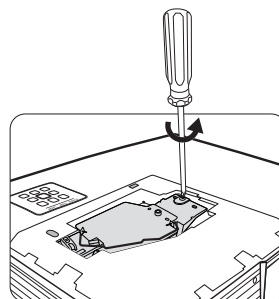

6. Lift the handle so that it stands up. Use the handle to slowly pull the lamp out of the projector.



- **Pulling it too quickly may cause the lamp to break and scatter broken glass in the projector.**
- **Do not place the lamp in locations where water might splash on it, children can reach it, or near flammable materials.**
- **Do not insert your hands into the projector after the lamp is removed. If you touch the optical components inside, it could cause color unevenness and distortion of the projected images.**

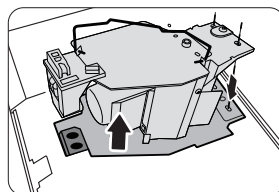

7. As shown in the figure, lower the new lamp into the lamp compartment while aligning the lamp with the holes in the lamp compartment. Make sure it fits in the projector.

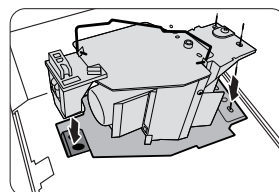

8. Tighten the screw that secures the lamp.



- **Loose screw may cause a bad connection, which could result in malfunction.**

- **Do not over tighten the screw.**

9. Ensure the handle is fully laid flat and locked in place.

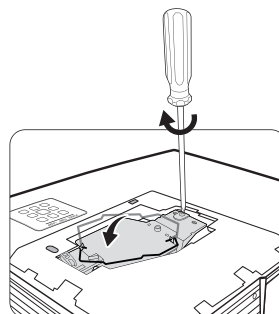

10. Put the lamp protection film supplied with the new lamp on the lamp compartment.
11. As shown in the figure, replace the lamp cover on the projector.

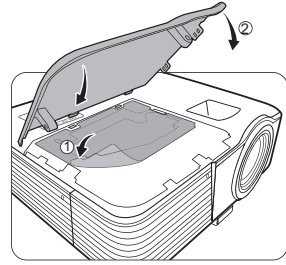

12. Tighten the screws that secure the lamp cover.



- **Loose screw may cause a bad connection, which could result in malfunction.**
- **Do not over tighten the screws.**

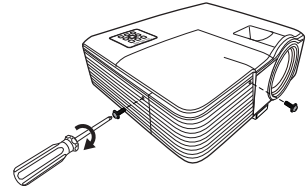

13. Restart the projector.



**Do not turn the power on with the lamp cover removed.**

#### Resetting the lamp timer

14. After the startup logo, open the On-Screen Display (OSD) menu. Go to the **SYSTEM SETUP: Advanced > Lamp Settings** menu. Press **OK/IMAGE**. The **Lamp Settings** page is displayed. Press **▼** to highlight **Reset lamp timer** and press **OK/IMAGE**. A warning message is displayed asking if you want to reset the lamp timer. Highlight **Reset** and press **OK/IMAGE**. The lamp time will be reset to '0'.

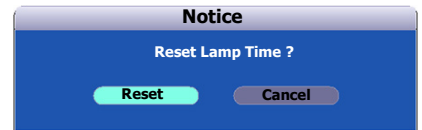

**Do not reset if the lamp is not new or replaced as this could cause damage.**

# Indicators

Light			Status & Description
POWER	TEMP	LAMP	
<b>Power events</b>			
<b>Orange</b>	<b>Off</b>	<b>Off</b>	Stand-by mode.
<b>Green Flashing</b>	<b>Off</b>	<b>Off</b>	Powering up.
<b>Green</b>	<b>Off</b>	<b>Off</b>	Normal operation.
<b>Orange Flashing</b>	<b>Off</b>	<b>Off</b>	Normal power-down cooling.
<b>Red</b>	<b>Off</b>	<b>Off</b>	FW Download.
<b>Green</b>	<b>Off</b>	<b>Red</b>	Color Wheel start fail.
<b>Red Flashing</b>	<b>Off</b>	<b>Off</b>	Scaler shutdown fail (data abort).
<b>Lamp events</b>			
<b>Off</b>	<b>Off</b>	<b>Red</b>	Lamp error in normal operation.
<b>Off</b>	<b>Off</b>	<b>Red Flashing</b>	Lamp is not lit up.
<b>Thermal events</b>			
<b>Red</b>	<b>Red</b>	<b>Off</b>	Fan 1 error (the actual fan speed is $\pm 25\%$ outside the desired speed).
<b>Red</b>	<b>Red Flashing</b>	<b>Off</b>	Fan 2 error (the actual fan speed is $\pm 25\%$ outside the desired speed).
<b>Red</b>	<b>Green</b>	<b>Off</b>	Fan 3 error (the actual fan speed is $\pm 25\%$ outside the desired speed).
<b>Green</b>	<b>Red</b>	<b>Off</b>	Temperature 1 error (over limited temperature, 55°C (131°F)).

# Troubleshooting

## ① The projector does not turn on

Cause	Remedy
There is no power from the power cable.	Plug the power cord into the AC inlet on the projector, and plug the power cord into the power outlet. If the power outlet has a switch, make sure that it is switched on.
Attempting to turn the projector on again during the cooling process.	Wait until the cooling down process has completed.

## ① No picture

Cause	Remedy
The video source is not turned on or connected correctly.	Turn the video source on and check that the signal cable is connected correctly.
The projector is not correctly connected to the input signal device.	Check the connection.
The input signal has not been correctly selected.	Select the correct input signal with the <b>SOURCE</b> key on the projector or remote control.
The lens cover is still closed.	Open the lens cover.

## ① Blurred image

Cause	Remedy
The projection lens is not correctly focused.	Adjust the focus of the lens using the focus ring.
The projector and the screen are not aligned properly.	Adjust the projection angle and direction as well as the height of the unit if necessary.
The lens cover is still closed.	Open the lens cover.
Depending on video signal timing, the projector needs to fine-tune for less blurred image.	Adjust Phase in the IMAGE menu.

## ① Remote control does not work

Cause	Remedy
The battery is out of power.	Replace the battery with a new one.
There is an obstacle between the remote control and the projector.	Remove the obstacle.
You are too far away from the projector.	Stand within 8 meters (26 feet) of the projector.

## ① The password is incorrect

Cause	Remedy
You do not remember the password.	Please see " <a href="#">Resetting the password function</a> " on page 32 for details.

## ① The LAN function cannot be used

Cause	Remedy
LAN control settings or LAN cable connection are problematic.	Verify the LAN control settings. Please see " <a href="#">Configuring the LAN Settings</a> " on page 48 for details. Make sure the LAN cables are properly connected.
The web page is not shown in the web browser or the web page is not responding.	Reload the page to see the data after changing on the screen. If the page is not showing the modified data, check the IP address of projector and log-in again.

# Specifications

## Projector specifications

 All specifications are subject to change without notice.

Model name		LV-WX320	LV-X320	LV-WX310ST	LV-X310ST
Display system		1-CHIP DLP™			
Optical system		Time division color extraction, sequential display			
Display device	Type	DMD			
	Size / Aspect ratio	0.65" x 1 / 16:10	0.55" x 1 / 4:3	0.65" x 1 / 16:10	0.55" x 1 / 4:3
	Drive system	DLP™ x 1 chip			
	Number dots / Total number dots	1,024,000 (1280 x 800) x 1 panel / 1,024,000	786,432 (1024 x 768) x 1 panel / 786,432	1,024,000 (1280 x 800) x 1 panel / 1,024,000	786,432 (1024 x 768) x 1 panel / 786,432
Projection lens	Zoom ratio / Focal length / F value	1.1x / 22–24.1mm / F2.56–2.68		N/A / 6.9mm / F2.60	
	Zooming / Focusing system	Manual / Manual		N/A / Manual	
	Lens shift	V: 50%, fixed	V: 60%, fixed	V: 55%, fixed	V: 65%, fixed
Light source		Super-high pressure mercury lamp 210W			
Image size (projection distance)		W: 60" to 180" (2 m to 6 m/6.6' to 19.7') T: 60" to 180" (2.2 m to 6.6 m/ 7.2' to 21.7')	W: 60" to 180" (2.38 m to 7.15 m/7.8' to 23.5') T: 60" to 180" (2.62 m to 7.87 m/8.6' to 25.8')	70" to 120" (0.74m to 1.26m/ 2.4' to 4.1')	60" to 120" (0.74m to 1.48m/ 2.4' to 4.9')
Number of colors		16,770,000 colors (full color)			
Brightness*1 (in presentation mode, HDMI input)		3200 lumen		3100 lumen	
Contrast ratio*1		10000:1 (Fully white: fully black, presentation mode, Analog PC input)			
Ratio of brightness at periphery to center*1		75%	80%	70%	80%
Speaker		10W • monaural x 1			
Maximum input resolution		1920 x 1080 dots			
Video signals	Analog PC input	UXGA/SXGA+/WXGA+/FWXGA/WXGA/SXGA/XGA/SVGA/VGA/MAC			
	HDMI input	From connected computers: UXGA/SXGA+/WXGA+/FWXGA/WXGA/SXGA/XGA/SVGA/VGA From connected AV equipment: 1080p/1080i/720p/576p/480p			
	Component video input	1080p/1080i/720p/576p/576i/480p/480i			
	Video input	NTSC/PAL/SECAM/NTSC4.43/PAL-M/PAL-N/PAL-60			
	S video input	NTSC/PAL/SECAM/NTSC4.43/PAL-M/PAL-N/PAL-60			

Model name		LV-WX320	LV-X320	LV-WX310ST	LV-X310ST
Input terminal	HDMI/MHL terminal	Digital PC, digital video, MHL input			
	ANALOG PC / COMPONENT terminal	Analog PC, Component (mini D-sub 15-pin)			
	Mini-DIN4	S video input			
	RCA terminal	Video input			
	LAN terminal	Network connection (100BASE-TX / 10BASE-T)			
	USB Port	Service port			
	CONTROL terminal	RS-232C (D-sub 9-pin)			
	AUDIO IN terminal	Audio signal (3.5φ stereo mini jack)			
AUDIO OUT terminal		Audio signal (3.5φ stereo mini jack)			
Input signal	Digital PC	TMDS (Transition Minimized Differential Signaling)			
	Analog PC	0.7Vp-p, positive polarity, impedance = 75 Ω Horizontal / vertical synchronization: TTL level, negative or positive polarity			
	Component video	COMPONENT: Separate Y Cb/Pb Cr/Pr signal Y: 1Vp-p, negative synchronization, impedance = 75 Ω Cb/Pb: 0.7Vp-p, impedance = 75 Ω Cr/Pr: 0.7Vp-p, impedance = 75 Ω			
	Audio	Impedance = 47k Ω or more			
Noise		36 / 29dB (Lamp mode: normal/eco)			
Operating temperature		0°C (32°F) to 40°C (104°F)			
Power supply		AC100V~240V 50 / 60Hz			
Power consumption		350 W (Max), < 240 W(eco) < 0.5 W (Standby) When setting is: Standby LAN:Off < 3 W (Standby) When setting is: Standby LAN:On			
Dimensions		W: 282 mm, H: 114.5 mm, D: 232 mm (including protrusion) W: 282 mm, H: 91 mm, D: 232 mm (not including protrusion)		W: 282 mm, H: 117.9 mm, D: 267.5 mm (including protrusion) W: 282 mm, H: 91 mm, D: 267.5 mm (not including protrusion)	
Weight		2.5 kg (5.5 lbs)		2.8 kg (6.2 lbs)	
Accessories		Remote control, remote control dry-cell batteries, power cord, PC cable, User's Manual (this manual), Important Information and Warranty Card			

 • **\*1 Compliance with ISO21118-2012**

- **Note that using the projector continuously for a long period of time may make the optical components deteriorate faster.**

# Dimensions

## LV-WX320/LV-X320

282 mm (W) x 114.5 mm (H) x 232 mm (D) / 11.1 in (W) x 4.5 in (H) x 9.1 in (D) (including the protrusion)

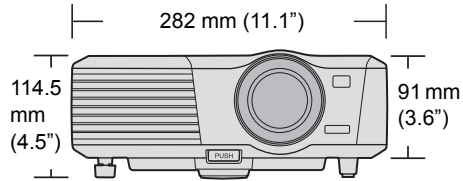
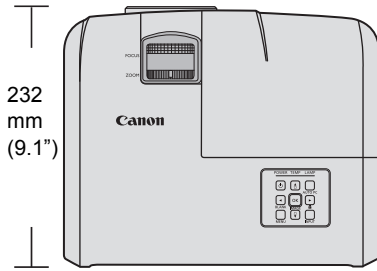

Tolerance: ±2 mm (0.08 in)

## LV-WX310ST/LV-X310ST

282 mm (W) x 117.9 mm (H) x 267.5 mm (D) / 11.1 in (W) x 4.6 in (H) x 10.5 in (D) (including the protrusion)

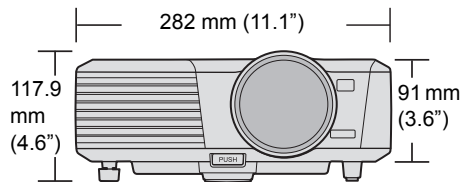
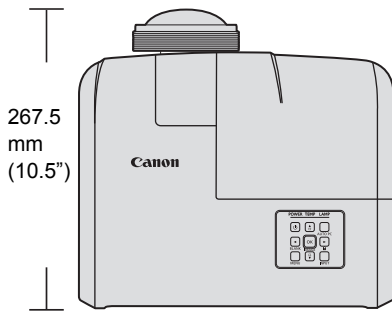

Tolerance: ±2 mm (0.08 in)

# Timing chart

## Supported timing for PC input

Resolution	Mode	Refresh Rate (Hz)	Horizontal Frequency (kHz)	Clock (MHz)
720 x 400	720 x 400_70	70.087	31.469	28.3221
640 x 480	VGA_60*	59.940	31.469	25.175
	VGA_72	72.809	37.861	31.500
	VGA_75	75.000	37.500	31.500
	VGA_85	85.008	43.269	36.000
800 x 600	SVGA_60*	60.317	37.879	40.000
	SVGA_72	72.188	48.077	50.000
	SVGA_75	75.000	46.875	49.500
	SVGA_85	85.061	53.674	56.250
	SVGA_120** (Reduce Blanking)	119.854	77.425	83.000
1024 x 768	XGA_60*	60.004	48.363	65.000
	XGA_70	70.069	56.476	75.000
	XGA_75	75.029	60.023	78.750
	XGA_85	84.997	68.667	94.500
	XGA_120** (Reduce Blanking)	119.989	97.551	115.500
1152 x 864	1152 x 864_75	75.00	67.500	108.000
1280 x 720	1280 x 720_60*	60	45.000	74.250
1280 x 768	1280 x 768_60*	59.870	47.776	79.5
1280 x 800	WXGA_60	59.810	49.702	83.500
	WXGA_75	74.934	62.795	106.500
	WXGA_85	84.880	71.554	122.500
	WXGA_120** (Reduce Blanking)	119.909	101.563	146.25
1280 x 1024	SXGA_60***	60.020	63.981	108.000
	SXGA_75	75.025	79.976	135.000
	SXGA_85	85.024	91.146	157.500
1280 x 960	1280 x 960_85	85.002	85.938	148.500
1360 x 768	1360 x 768_60***	60.015	47.712	85.500
1440 x 900	WXGA+_60***	59.887	55.935	106.500
1400 x 1050	SXGA+_60***	59.978	65.317	121.750
1600 x 1200	UXGA***	60.000	75.000	162.000
1680 x 1050	1680 x 1050_60***	59.954	65.290	146.250
1366 x 768	1366 x 768_60	59.790	47.712	85.500
1600 x 900	1600 x 900_60	60.000	60.000	108.000

 \*Supported timing for 3D signal in Frame Sequential, Top-Bottom and Side-By-Side formats.

\*\*Supported timing for 3D signal in Frame Sequential format.

\*\*\*Supported timing for 3D signal in Top-Bottom and Side-By-Side formats.



## Supported timing for HDMI (HDCP) input

### Supported PC timings

Resolution	Mode	Vertical Frequency (Hz)	Horizontal Frequency (kHz)	Clock (MHz)
720 x 400	720 x 400_70	70.087	31.469	28.3221
640 x 480	VGA_60*	59.940	31.469	25.175
	VGA_72	72.809	37.861	31.500
	VGA_75	75.000	37.500	31.500
	VGA_85	85.008	43.269	36.000
800 x 600	SVGA_60*	60.317	37.879	40.000
	SVGA_72	72.188	48.077	50.000
	SVGA_75	75.000	46.875	49.500
	SVGA_85	85.061	53.674	56.250
	SVGA_120** (Reduce Blanking)	119.854	77.425	83.000
1024 x 768	XGA_60*	60.004	48.363	65.000
	XGA_70	70.069	56.476	75.000
	XGA_75	75.029	60.023	78.750
	XGA_85	84.997	68.667	94.500
	XGA_120** (Reduce Blanking)	119.989	97.551	115.500
1152 x 864	1152 x 864_75	75.00	67.500	108.000
1280 x 720	1280 x 720_60*	60	45.000	74.250
1280 x 768	1280 x 768_60*	59.870	47.776	79.5
1280 x 800	WXGA_60*	59.810	49.702	83.500
	WXGA_75	74.934	62.795	106.500
	WXGA_85	84.880	71.554	122.500
	WXGA_120** (Reduce Blanking)	119.909	101.563	146.25
1280 x 1024	SXGA_60***	60.020	63.981	108.000
	SXGA_75	75.025	79.976	135.000
	SXGA_85	85.024	91.146	157.500
1280 x 960	1280 x 960_85	85.002	85.938	148.500
1360 x 768	1360 x 768_60***	60.015	47.712	85.500
1440 x 900	WXGA+_60***	59.887	55.935	106.500
1400 x 1050	SXGA+_60***	59.978	65.317	121.750
1600 x 1200	UXGA***	60.000	75.000	162.000
1680 x 1050	1680 x 1050_60***	59.954	65.290	146.250
1366 x 768	1366 x 768_60	59.790	47.712	85.500
1600 x 900	1600 x 900_60	60.000	60.000	108.000

 \*Supported timing for 3D signal in Frame Sequential, Top-Bottom and Side-By-Side formats.

\*\*Supported timing for 3D signal in Frame Sequential format.

\*\*\*Supported timing for 3D signal in Top-Bottom and Side-By-Side formats.

## Supported MHL timings

Timing	Resolution	Horizontal Frequency (kHz)	Vertical Frequency (Hz)	Dot Clock Frequency (MHz)
480i	720(1440) x 480	15.73	59.94	27
480p	720 x 480	31.47	59.94	27
576i	720(1440) x 576	15.63	50	27
576p	720 x 576	31.25	50	27
720/50p	1280 x 720	37.5	50	74.25
720/60p	1280 x 720	45	60	74.25
1080/24P	1920 x 1080	27	24	74.25
1080/25P	1920 x 1080	28.13	25	74.25
1080/30P	1920 x 1080	33.75	30	74.25
1080/50i	1920 x 1080	28.13	50	74.25
1080/60i	1920 x 1080	33.75	60	74.25
1080/50p	1920 x 1080	56.26	50	148.5
1080/60p	1920 x 1080	67.5	60	148.5

## Supported Video timings

Timing	Resolution	Horizontal Frequency (kHz)	Vertical Frequency (Hz)	Dot Clock Frequency (MHz)
480i*	720(1440) x 480	15.73	59.94	27
480p	720 x 480	31.47	59.94	27
576i	720(1440) x 576	15.63	50	27
576p	720 x 576	31.25	50	27
720/50p**	1280 x 720	37.5	50	74.25
720/60p**	1280 x 720	45.00	60	74.25
1080/24P**	1920 x 1080	27	24	74.25
1080/30P	1920 x 1080	33.75	30	74.25
1080/50i***	1920 x 1080	28.13	50	74.25
1080/60i***	1920 x 1080	33.75	60	74.25
1080/50P	1920 x 1080	56.25	50	148.5
1080/60P	1920 x 1080	67.5	60	148.5

 \*Supported timing for 3D signal in Frame Sequential format.

\*\*Supported timing for 3D signal in Frame Packing and Top-Bottom formats.

\*\*\*Supported timing for 3D signal in Side-By-Side format.

### ***Supported timing for Component-YPbPr input***

Timing	Resolution	Horizontal Frequency (kHz)	Vertical Frequency (Hz)	Dot Clock Frequency (MHz)
480i	720 x 480	15.73	59.94	13.5
480p	720 x 480	31.47	59.94	27
576i	720 x 576	15.63	50	13.5
576p	720 x 576	31.25	50	27
720/50p	1280 x 720	37.5	50	74.25
720/60p	1280 x 720	45	60	74.25
1080/50i	1920 x 1080	28.13	50	74.25
1080/60i	1920 x 1080	33.75	60	74.25
1080/50P	1920 x 1080	56.25	50	148.5
1080/60P	1920 x 1080	67.5	60	148.5

☞ **Displaying a 1080i(1125i)@60Hz or 1080i(1125i)@50Hz signal may result in slight image vibration.**

### ***Supported timing for Video and S-Video inputs***

Video mode	Horizontal Frequency (kHz)	Vertical Frequency (Hz)	Sub-carrier Frequency (MHz)
NTSC	15.73	60	3.58
PAL	15.63	50	4.43
SECAM	15.63	50	4.25 or 4.41
PAL-M	15.73	60	3.58
PAL-N	15.63	50	3.58
PAL-60	15.73	60	4.43
NTSC4.43	15.73	60	4.43

# Control Commands

You can control this projector by sending commands via CONTROL port or LAN port.

## System Requirement

### CONTROL port

Connection Cable	9-pin RS-232-C Cable (Crossover)
Communication Mode	RS-232-C asynchronous, half-duplex communication
Baud Rate	19200 bps
Character Length	8 bit
Parity Check	None
Stop Bits	2 bit
Flow Control	None

### LAN port

Connection System	TCP/IP Connection
Port	33336

### Control Command

Function	Read/Write	Operation	Command (ASCII)	Note
<b>Power</b>	W	Power On	POWER=ON<CR>	Enable during "Standby" state.
	W	Power Off	POWER=OFF<CR>	
	R	Power Status	GET=POWER<CR>	Enable during any power state. [Warming up] g:POWER=OFF2ON [Cooling down] g:POWER=ON2OFF
<b>Source Selection</b>	W	Computer1	INPUT=DSUB1<CR>	
	W	Computer2	INPUT=DSUB2<CR>	
	W	HDMI	INPUT=HDMI<CR>	
	W	Video	INPUT=VIDEO<CR>	
	W	S-Video	INPUT=S-VIDEO<CR>	
	R	Current source	GET=INPUT<CR>	
<b>Audio Control</b>	W	Mute On	MUTE=ON<CR>	
	W	Mute Off	MUTE=OFF<CR>	
	R	Mute Status	GET=MUTE<CR>	
	W	Volume +	RC=VOL_P<CR>	
	W	Volume -	RC=VOL_M<CR>	
	R	Volume Status	GET=AVOL<CR>	

<b>Image Mode</b>	W	Presentation	IMAGE=PRESENTATION<CR>	
	W	Standard	IMAGE=STANDARD<CR>	
	W	sRGB	IMAGE=SRGB<CR>	
	W	Movie	IMAGE=MOVIE<CR>	
	W	User1	IMAGE=USER_1<CR>	
	W	User2	IMAGE=USER_2<CR>	
	R	Image Mode	GET=IMAGE<CR>	
<b>Aspect</b>	W	Aspect 4:3	ASPECT=4:3<CR>	
	W	Aspect 16:9	ASPECT=16:9<CR>	
	W	Aspect Auto	ASPECT=AUTO<CR>	
	W	Aspect Real	ASPECT=TRUE<CR>	
	W	Aspect 16:10	ASPECT=16:10<CR>	
	R	Aspect Status	GET=ASPECT<CR>	
<b>Image Flip H/V</b>	W	Front Table	IMAGEFLIP=NONE<CR>	
	W	Rear Table	IMAGEFLIP=REAR<CR>	
	W	Front Ceiling	IMAGEFLIP=CEILING<CR>	
	W	Rear Ceiling	IMAGEFLIP= REAR_CEIL<CR>	
	R	Image flip H/V Status	GET=IMAGEFLIP<CR>	
<b>Auto Search</b>	W	Auto search	QAS=ON<CR>	
	W	Auto search	QAS=OFF<CR>	
	R	Auto search status	GET=QAS<CR>	
<b>Lamp</b>	R	Lamp Hour	GET=LMPT<CR>	
	W	Lamp Mode Normal	LAMP=NORMAL<CR>	
	W	Lamp Mode Economic	LAMP=ECO<CR>	
	R	Lamp Mode Status	GET=LAMP<CR>	

<b>Operation</b>	W	Blank On	BLANK=ON<CR>	
	W	Blank Off	BLANK=OFF<CR>	
	R	Blank Status	GET=BLANK<CR>	
	W	Freeze On	FREEZE=ON<CR>	
	W	Freeze Off	FREEZE=OFF<CR>	
	R	Freeze Status	GET=FREEZE<CR>	
	W	Menu On	MENU=ON<CR>	
	W	Menu Off	MENU=OFF<CR>	
	W	Auto PC	RC=AUTOPC<CR>	
	W	Up	RC=UP<CR>	
	W	Down	RC=DOWN<CR>	
	W	Right	RC=RIGHT<CR>	
	W	Left	RC=LEFT<CR>	
	W	OK	RC=OK<CR>	
<b>High Altitude</b>	W	High Altitude mode On	HIGHALT=ON<CR>	
	W	High Altitude mode Off	HIGHALT=OFF<CR>	
	R	High Altitude mode status	GET=HIGHALT<CR>	

### Control Response

Read/Write	Condition	Response	Example
W	Success	i:OK<CR>	< BLANK=ON<CR> > i:OK<CR>
W	Illegal format : Don't exist command or structure	e:0002 INVALID_COMMAND<CR>	< INVALID=ON<CR> > e:0002 INVALID_COMMAND<CR>
W	Unsupported item: this command parameter can't support	e:000A INVALID_PARAMETER<CR>	< BLANK=INVALID<CR> > e:000A INVALID_PARAMETER<CR>
W	Block item: Current state can't use.	e:1011 FUNCTION_NOT_AVAILABLE<CR>	< ASPECT=AUTO<CR> > e:1011 FUNCTION_NOT_AVAILABLE<CR>
R	Success	g:XXX=YYY<CR> XXX=Command Name, YYY=Parameter Name	< GET=BLANK<CR> > g:BLANK=ON<CR>

---

R	Unsupported item: this command parameter can't support	e:000A INVALID_PARAMETER<CR>	< GET=INVALID<CR> > e:000A INVALID_PARAMETER<CR>
---	-----------------------------------------------------------------	---------------------------------	--------------------------------------------------------

- ☞ • **If the projector didn't receive <CR> to finish a command within 5 seconds, it will timeout and you need to resend the command.**
- **No case sensitive.**



**CANON INC.**

30-2, Shimomaruko 3-chome, Ohta-ku, Tokyo 146-8501, Japan

**CANON U.S.A. INC.**

One Canon Park, Melville, New York 11747, U.S.A.

For all inquires concerning this product, call toll free in the U.S. 1-800-OK-CANON

**CANON EUROPE LTD.**

3 The Square, Stockley Park, Uxbridge, Middlesex, UB11 1ET United Kingdom

**CANON EUROPA N.V.**

Bovenkerkerweg 59, 1185 XB Amstelveen, The Netherlands