

SONY



VPL-FHZ65 / FHZ60 / FHZ57

3LCD Laser Projector

VPL-FH65 / FH60

3LCD Installation Projector

Z-Phosphor
LASER LIGHT SOURCE



BrightEra™
Long Lasting Optics

HDMI

4HDBT™
ASE

Bright, Beautiful Images with Low Running Costs, Minimal Maintenance, and Flexible Installation

Because no two organizations are alike, Sony aims to meet diverse installation and budget requirements with its range of professional laser and lamp projectors. There are models to suit every commercial, academic, large-scale, and entertainment application. The VPL-FHZ65, VPL-FHZ60 and VPL-FHZ57 laser projectors are ideal for a wide range of business and education applications. Their powerful Z-Phosphor™ laser light source is teamed with Sony's advanced 3LCD projection engine to deliver extremely bright, rich, and stable colors. For applications better-suited to lamp-based projection, the VPL-FHZ65, VPL-FHZ60 and VPL-FHZ57 projectors offer cost-effective options that nevertheless deliver high-quality performance. You can choose brightness of 6,000 lumens (VPL-FHZ65/FH65), 5,000 lumens (VPL-FHZ60/FH60) or 4,100 lumens (VPL-FHZ57) with WUXGA resolution images, and each model uses BrightEra panel technology to reproduce natural and vivid color. All of these projectors are designed to deliver enhanced picture quality with advanced features such as Reality Creation and Contrast Enhancer- both of these technologies are already used by Sony's home theater projection systems for high-end consumer entertainment. The Reality Creation engine analyzes and processes every input signal to refine detail, clarity, and sharpness for naturally up-scaled image. The Contrast Enhancer feature expands the perceived dynamic range of the signal in real-time. Both features contribute to enhancing the visual experience wherever these projectors are installed. The laser projectors (VPL-FHZ65/FH60/FHZ57) pack all the benefits of laser technology into a blend-in design. A laser light source means avoiding lamp-related problems: lamps need to slowly warm up and cool down, they limit the tilt angle, and typically they force a compromise between high brightness and high resolution. The VPL-FHZ65, VPL-FHZ60 and VPL-FHZ57 deliver instant on/off. Turn the projector on and you have immediate full brightness. Turn it off and you're done. You're not even limited in the number or duration of on/off cycles. It's the total convenience that today's users expect. All four models have a built-in, HDBaseT™ interface, enabling easier connectivity and reducing total system cost by using single category cable which runs all the video, audio, control, and IP signals up to 328 ft' (100 m). These projectors also have a new integrated terminal cover design which allows installation without any visible cable runs from any angle. The integrated cover also helps you to manage cables without attaching any external cable cover boxes (avoiding a bulky installation). In addition, these projectors have a wide powered lens shift, which allows their installation in challenging environments. And each can be combined with wide variety of optional lenses to suit specific installation requirements. Available optional lenses include 0.65:1 short throw and tele-zoom with a throw range of up to 4.84:1, with a bayonet lens mounting system for easier, quicker lens interchange. Offering a stylish blend-in design, tidy cable management, and low fan noise, these five projectors can fit smoothly into almost any environment - from entertainment venues to academic institutions to corporate spaces.



For business



For academic use



For entertainment

Slim, Attractive, Blend-in Design

The slim, stylish case design features a flat top surface that blends in discreetly when the projector is ceiling mounted. The clean appearance is accentuated by a new terminal cover that reduces cable clutter.



High Image Quality

VPL-FHZ65/FHZ60/FHZ57

Very High Image Quality with 3LCD Projection System and Z-Phosphor Laser Light Source

Combining a Z-Phosphor laser light source with a 3LCD optical system, the ground-breaking VPL-FHZ65, VPL-FHZ60 and VPL-FHZ57 projectors generate a powerful 6,000 lumens, 5,000 lumens and 4,100 lumens respectively of color light output at WUXGA resolution. Each projector's light engine uses blue laser as its light source, which excites a phosphorous material that in turn creates white light. The white light is delivered to the 3LCD optical system, which generates constant, vibrant RGB color through a color-splitting process. This produces brightness sufficient for a broad range of commercial, academic, and entertainment applications.

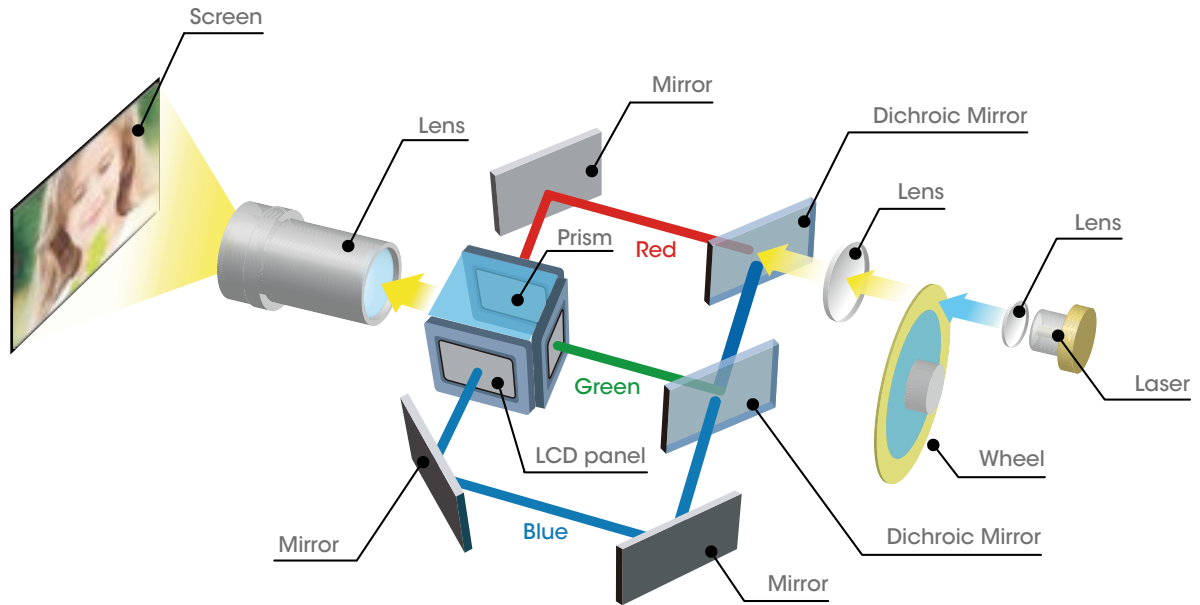

VPL-FHZ65/FHZ60/FHZ57

VPL-FH65/FH60

Crisp, Detail-packed WUXGA Resolution Images

These projectors deliver an amazing WUXGA resolution (1920 x 1200), which exceeds Full-HD resolution (1920 x 1080). It also allows projection in a wider display range. More information can be displayed on screen, so you can see the whole page without scrolling. Extremely clear and detailed high-quality images are projected, even on a large screen, and native Full-HD images can be projected full screen. These ground-breaking projectors are the ultimate tool for projecting images in a range of applications requiring exceptional detail.



WUXGA picture quality



WUXGA picture quality

Simulated images
Licensed by Tokyo Tower

Advanced Picture Refinement Technologies

- See Extreme Clarity in Every Pixel

Developed for Sony's home theater projectors, the Reality Creation function has now been adapted for the VPL-FHZ65, VPL-FHZ60, VPL-FHZ57, VPL-FH65 and VPL-FH60. It reproduces the texture and color of the original WUXGA signal by restoring missing information lost during packaging of the original contents to disk and broadcast transmission.



- Dynamic Image with High Contrast

The Contrast Enhancer function automatically adjusts the contrast for optimum viewing. It compensates for dark and bright parts of an image by analyzing the signal component of each scene in real time to enhance contrast.

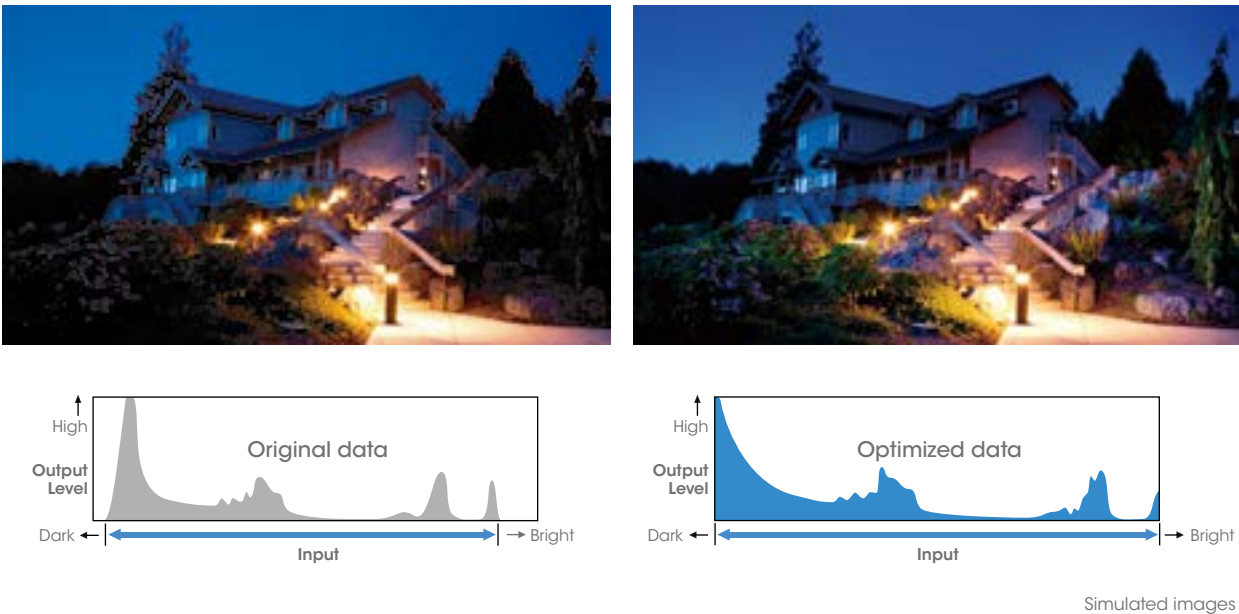

Good TCO & Energy Efficient

VPL-FHZ65/FHZ60/FHZ57

Up to 20,000 Hours* of Virtually Zero Maintenance Operation

Thanks to its Z-Phosphor laser light source with control technology, long-life LCD panel, and advanced filter system, the laser projectors (VPL-FHZ65/FHZ60/FHZ57) offer up to 20,000 hours* of operation without maintenance or replacement. Virtually zero maintenance requirements and a range of energy-saving features reduce total lifetime ownership costs compared with conventional projectors.

* Actual hours may vary depending on usage environment.

VPL-FHZ65/FHZ60/FHZ57

VPL-FH65/FH60

Hassle-free Automatic Filter Cleaning

Now you can focus on great-looking images instead of arduous maintenance tasks. A new automated filter cleaning system removes dust every 100 hours.

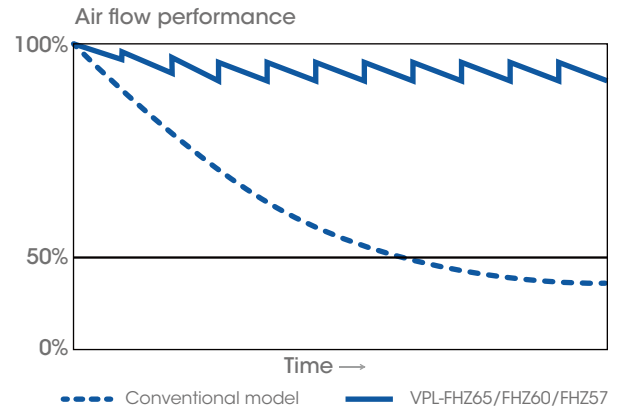
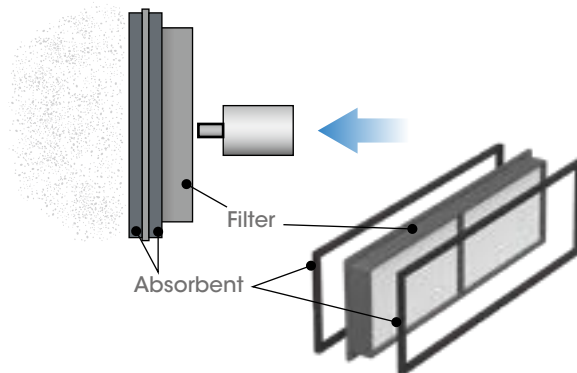

Simulated images

Energy-efficient Functions

VPL-FHZ65/FHZ60/FHZ57

• Auto Dimming Mode

The laser projectors are equipped with a light source dimming function. After 10 seconds of a static signal feed, the light source dims by approximately 15% which is barely noticeable. If the VPL-FHZ65, VPL-FHZ60 and VPL-FHZ57 are left powered on while not in use, after a set period of time the unit will automatically detect no change of signal input and will dim the light source to as low as approximately 5% of original brightness to significantly reduce energy consumption.

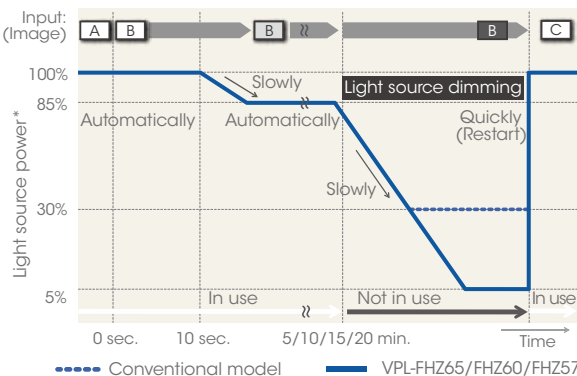

* Light source mode: High. The values are approximate.

When the input signal is unchanged, the unit shifts into dimming mode

Simulated images

VPL-FHZ65/FHZ60/FHZ57

• Auto Light Source Control for Energy Saving

The brightness of the light source's output is automatically adjusted depending on the brightness of the projected image, to avoid unnecessary power consumption. When showing darker images that don't require high brightness, the light source output decreases.

Light source drive

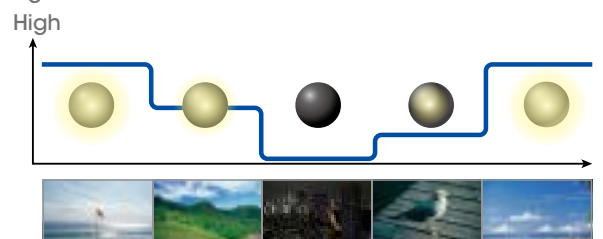

Simulated images

VPL-FHZ65/FHZ60/FHZ57

VPL-FH65/FH60

• Blank (Picture Muting)

The projectors can temporarily disable video signal output. This function can be easily operated with just the touch of a button on the supplied Remote Commander unit. In addition, this function allows blank image projection with low power consumption using light source control technology.

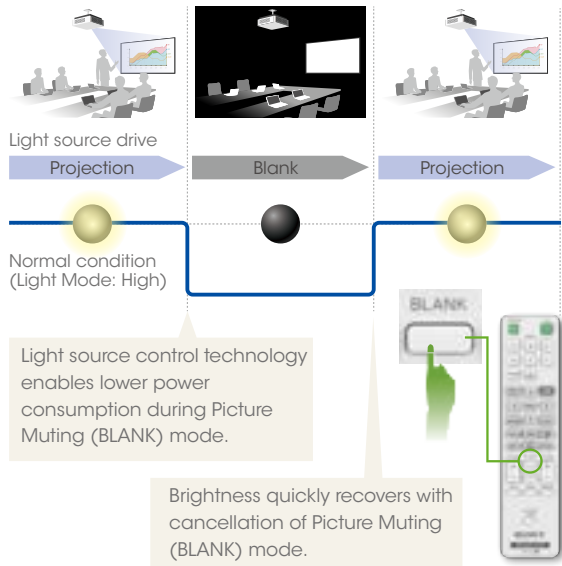

Simulated images

VPL-FHZ65/FHZ60/FHZ57

VPL-FH65/FH60

Included Powered Standard Zoom Lens Plus Wide Choice of Lens Options

Installation flexibility is increased by a wide range of compatible lens options to suit virtually any size of room and throw requirement. The quick-release bayonet mount simplifies quick lens exchange.

VPL-FHZ65/FHZ60/FHZ57

Tilt Angle-free

Enjoy greater installation flexibility by positioning the projector freely at any angle – on its side or even upside down.



VPL-FHZ65/FHZ60/FHZ57

VPL-FH65/FH60

Simple Installation with HDBaseT

HDBaseT is a multi-signal transmission system via a single cable, which simplifies the installation task. It cuts total system cost by reducing not just cabling requirements but also the number of required signal extenders and receiver boxes. One Cat5e/6 cable can run up to 100 meters, reducing the number of cable runs and eliminating the need for signal extenders. And fewer signal extenders and receiver boxes mean fewer potential points of failure. In addition, Cat5e/6 cables are much easier to terminate than cables such as HDMI, and therefore can be simply and quickly terminated even onsite during the installation process.

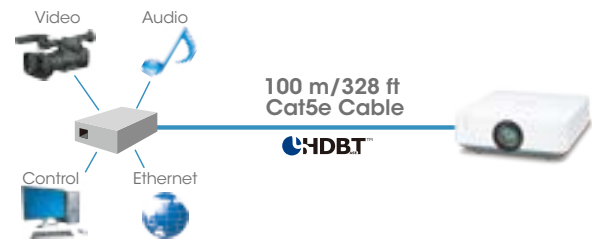

VPL-FHZ65/FHZ60/FHZ57

VPL-FH65/FH60

Project onto Non-flat Surfaces with Image Warping

Easily correct image geometry for natural-looking projections, even on convex or concave surfaces. Corner and edge correction can be easily adjusted with the supplied remote and onscreen menu.



Four corners correction

Four sides correction

Simulated images

Installation Advantages

VPL-FHZ65/FHZ60/FHZ57

VPL-FH65/FH60

Powered Lens Shift Function*

All of these projectors have a Lens Shift function. Using this function, the position of the projected image can be moved vertically by -32% to +32% and horizontally by -5% to +60%. Images can be easily adjusted to the desired settings during installation. With this exceptional shift range, the projectors can be installed in ways to maximize performance even in the most difficult environments.

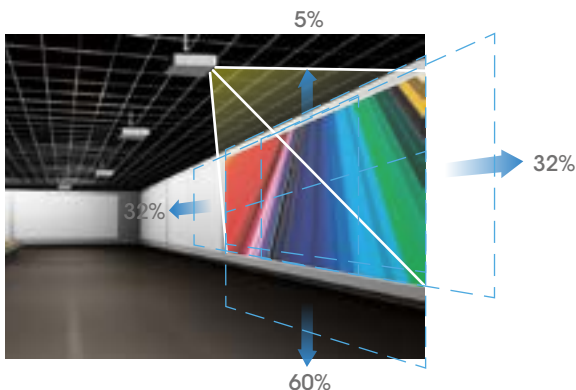

* Depends on lens

Simulated images

VPL-FHZ65/FHZ60/FHZ57

VPL-FH65/FH60

Create Supersize Displays with Edge Blending

Seamlessly join accurately color-matched images from multiple projectors, simplifying the creation of stunning supersize displays for retail, corporate, and live event applications.



Simulated images

VPL-FHZ65/FHZ60/FHZ57

VPL-FH65/FH60

Super Quiet Operation Noise

The VPL-FHZ65, VPL-FHZ60 and VPL-FHZ57 are industry's quietest*1 laser-phosphor 3LCD projector. Low fan noise*2 ensures discreet, unobtrusive operation in quiet environments, from museums and galleries to lecture theaters.

*1 As of September 2015

*2 VPL-FHZ65/FHZ60: 34 dB/28 dB (Light Mode: High/Standard)
VPL-FHZ57 : 33 dB/28 dB (Light Mode: High/Standard)
VPL-FH65/FH60 : 35 dB/28 dB (Lamp Mode: High/Standard)

VPL-FHZ65/FHZ60/FHZ57

VPL-FH65/FH60

Professional Calibration

The projectors offer a professional calibration function to adjust the hue, saturation and brightness of each target color to get exactly the picture you want. With this capability, you can tweak the images to perfection.



Simulated images

In addition to that, the projectors adjust the color space for red, green and blue, tweak the images according to installation condition.

User Advantages

VPL-FHZ65/FHZ60/FHZ57

Constant Brightness Mode for Stable Projection

Constant brightness mode allows you to maintain brightness throughout the expected 20,000* hour life by driving each laser projector at reduced light output. This is useful for applications including museums, conference rooms, or even classrooms where you want to maintain a consistent visual experience for the audience.

* Actual hours may vary depending on usage environment.

VPL-FHZ65/FHZ60/FHZ57

Save Time with Every Presentation

The laser projectors deliver instant on/off. Turn the unit on and you have immediate full brightness. Turn it off and you're done. You're not even limited in the number or duration of on/off cycles. It's the total convenience that today's users expect.

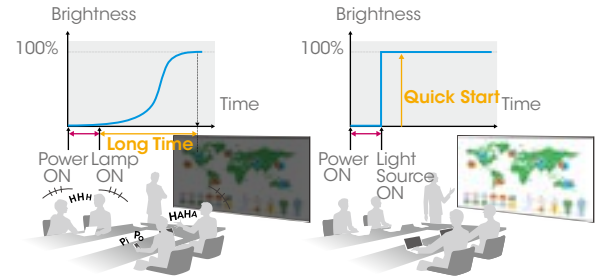

Conventional lamp model

VPL-FHZ65/FHZ60/FHZ57

Simulated images

VPL-FHZ65/FHZ60/FHZ57

VPL-FH65/FH60

Picture Mode

New modes ensure great-looking pictures in any presentation conditions. Select Standard, Dynamic, Brightness Priority, or Multi-screen Picture mode for optimized image quality, with any source and in every room.

VPL-FHZ65/FHZ60/FHZ57

VPL-FH65/FH60

Simple Setup with Friendly New Installation Menu

You can use the remote commander to easily adjust projector settings, including warping and edge blending.

VPL-FHZ65/FHZ60/FHZ57

VPL-FH65/FH60

Project Side by Side

Project images from two inputs at the same time—it's ideal for applications such as video conferencing and medical training where two images need to be seen simultaneously.

VPL-FHZ65/FHZ60/FHZ57

VPL-FH65/FH60

Closed Captioning

Official teletext broadcasting, developed by the NCI, USA

VPL-FHZ65/FHZ60/FHZ57

VPL-FH65/FH60

Network and Control

Controls and monitors projector status
Compatible with various control systems



OPTIONAL LENSES

Projection lens	VPLL-3007	VPLL-Z3009	VPLL-Z3024	VPLL-Z3032
Throw ratio	0.65:1	0.85:1 to 1.0:1	2.34:1 to 3.19:1	3.18:1 to 4.84:1
Zoom / Focus	— / Manual	Manual / Manual	Powered / Powered	Powered / Powered
Lens shift	Vertical: Upward 10% to Downward 5% Horizontal: Right 4% to Left 4%	Vertical: Upward 50% to Downward 5% Horizontal: Right 24% to Left 24%	Vertical: Upward 60% to Downward 5% Horizontal: Right 32% to Left 32%	Vertical: Upward 60% to Downward 5% Horizontal: Right 32% to Left 32%
Aperture	f/1.75	f/1.85 to 2.1	f/2.00 to 2.30	f/2.00 to 2.40
Screen size*	60" to 300"	60" to 300"	40" to 600"	40" to 600"
Dimensions	W 150 x H 150 x D 222 mm	W 150 x H 150 x D 217 mm	W 97 x H 105 x D 177 mm	W 97 x H 105 x D 177 mm
Mass	1.7 kg	1.7 kg	1.2 kg	1.2 kg

* Viewable area, measured diagonally.

LENS THROW RATIO CHART

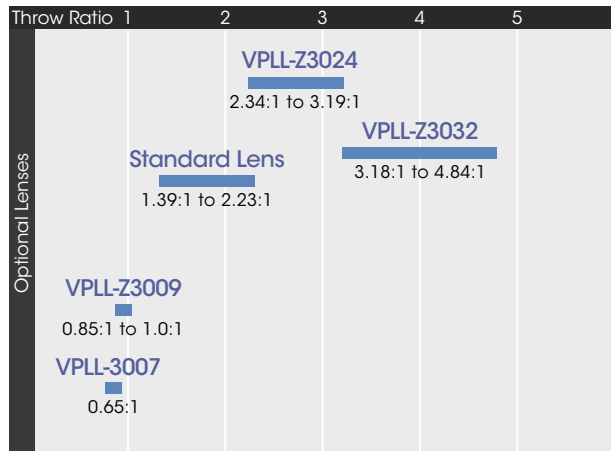

The distance L is between the front of the lens (center) and the front of the cabinet.

Unit: mm (inches)

Lens	L'	Type
Standard lens	1.2 (1/6)	②
VPLL-3007	52.4 (2 1/16)	②
VPLL-Z3009	51.2 (2 1/32)	②
VPLL-Z3024	9.9 (3/8)	②
VPLL-Z3032	9.9 (3/8)	②

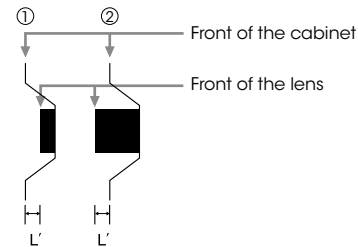

INSTALLATION DIAGRAM

Unit: m (inches)

Projection image size		Projection distance L				
Diagonal	Width x Height	Standard lens	VPLL-3007	VPLL-Z3009	VPLL-Z3024	VPLL-Z3032
80-inch (2.03 m)	1.72 x 1.08 (68 x 42)	2.36 – 3.86 (93 – 152)	1.09 (43)	1.44 – 1.69 (57 – 66)	4.00 – 5.48 (158 – 215)	5.45 – 8.32 (215 – 327)
100-inch (2.54 m)	2.15 x 1.35 (85 x 53)	2.96 – 4.84 (117 – 191)	1.38 (54)	1.82 – 2.13 (72 – 84)	5.03 – 6.87 (198 – 270)	6.84 – 10.43 (270 – 410)
120-inch (3.05 m)	2.58 x 1.62 (102 x 64)	3.57 – 5.82 (141 – 229)	1.67 (66)	2.20 – 2.57 (87 – 101)	6.05 – 8.27 (238 – 325)	8.24 – 12.55 (325 – 494)
150-inch (3.81 m)	3.23 x 2.02 (127 x 79)	4.47 – 7.29 (176 – 287)	2.11 (83)	2.76 – 3.23 (109 – 127)	7.59 – 10.36 (299 – 408)	10.33 – 15.72 (407 – 619)
200-inch (5.08 m)	4.31 x 2.69 (170 x 106)	5.97 – 9.73 (235 – 383)	2.83 (112)	3.70 – 4.34 (146 – 170)	10.15 – 13.85 (400 – 545)	13.82 – 21.00 (544 – 827)

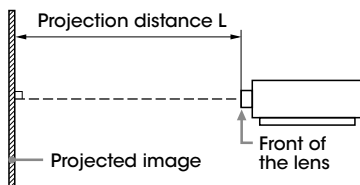

PRESET SIGNAL CHART

Computer Signal

Resolution	fH [kHz]/ fV [Hz]	Input connector	
		RGB ^{*1}	DVI-D ² /HDMI ⁶ / Digital Interface Adaptor BKM- PJ10 ⁷ /3G-SDI INPUT Adaptor BKM-PJ20 ⁷
640 x 350	31.5/70	●	—
	37.9/85	●	—
640 x 400	31.5/70	●	—
	37.9/85	●	—
640 x 480	31.5/60	●	●
	35.0/67	●	—
	37.9/73	●	—
	37.5/75	●	—
800 x 600	43.3/85	●	—
	35.2/56	●	—
	37.9/60	●	●
	48.1/72	●	—
832 x 624	46.9/75	●	—
	53.7/85	●	—
1024 x 768	49.7/75	●	—
	48.4/60	●	●
	56.5/70	●	—
1152 x 864	60.0/75	●	—
	68.7/85	●	—
	64.0/70	●	—
1152 x 900	67.5/75	●	—
	77.5/85	●	—
1280 x 960	61.8/66	●	—
	60.0/60	●	●
1280 x 1024	75.0/75	●	—
	64.0/60	●	●
	80.0/75	●	—
1400 x 1050	91.1/85	●	—
	65.3/60	●	●
1600 x 1200	47.8/60	●	●
1280 x 768	45.0/60	●	● ^{*2}
1280 x 720	67.5/60	—	● ^{*2}
1920 x 1080	47.7/60	●	●
1366 x 768	55.9/60	●	●
1440 x 900	65.3/60	●	●
1680 x 1050	49.7/60	●	●
1280 x 800	74.0/60	● ^{*1}	● ^{*1}
1920 x 1200	60.0/60	● ^{*1}	● ^{*1}
1600 x 900			

Video Signal

Signal	fV [Hz]	Input connector		
		VIDEO/ S VIDEO	INPUT A	INPUT B/ INPUT C/ INPUT D
NTSC	60	●	—	—
PAL/SECAM	50	●	—	—
480i	60	—	●	●
576i	50	—	●	●
480p	60	—	●	●
576p	50	—	●	●
1080i	60	—	●	●
1080i	50	—	●	●
720p	60	—	●	● ^{*2}
720p	50	—	●	●
1080p	60	—	—	● ^{*2}
1080p	50	—	—	●
1080p	24	—	—	●

*1: Available for VESA Reduced Blanking signals only.

*2: INPUT B is determined as a computer signal; INPUT C/INPUT D is determined as a video signal.

- When a signal other than the signals listed in the table is input, the picture may not be displayed properly.
- An input signal meant for a screen resolution that differs from that of the panel will not be displayed in its original resolution. Text and lines may be uneven.
- Some actual value may differ slightly from the design values given in the table.

OPTIONAL ACCESSORIES



LMP-F370
Projector Lamp



LMP-F280
Projector Lamp

CONNECTOR PANELS

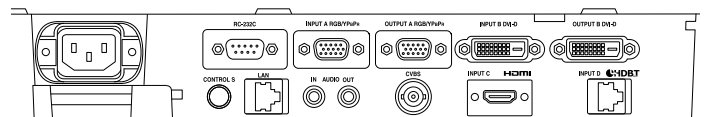

DIMENSIONS

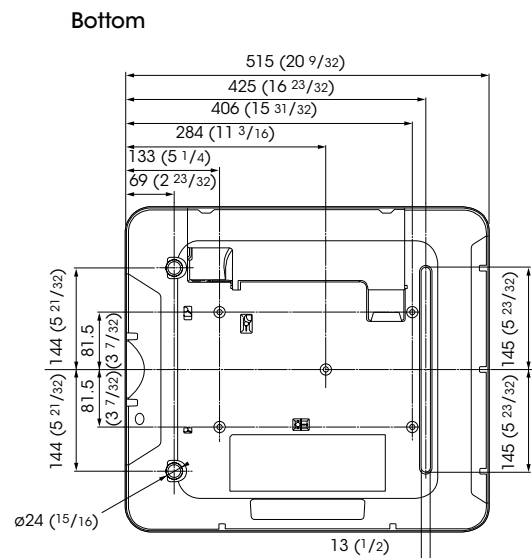
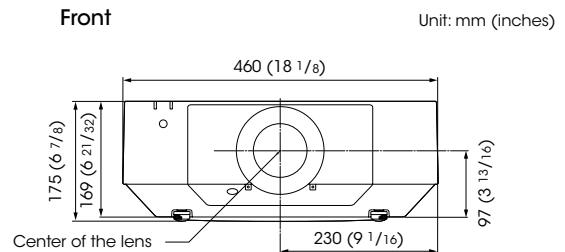

SPECIFICATIONS

		VPL-FHZ65	VPL-FHZ60	VPL-FHZ57	VPL-FH65	VPL-FH60
Display system		3 LCD system				
Display device	Size of effective display area	0.76" (19 mm) x 3 BrightEra LCD Panel, Aspect ratio: 16:10			0.76" (19 mm) x 3 BrightEra LCD Panel, Aspect ratio: 16:10	
	Number of pixels	6,912,000 (1920 x 1200 x 3) pixels				
Projection lens*1	Zoom	Powered (Approx. x 1.6)			Powered (Approx. x 1.6)	
	Focus	Powered				
	Lens shift	Powered, Vertical: -5%, +60%, Horizontal: +/-32%			Powered, Vertical: -5%, +60%, Horizontal: +/-32%	
	Throw ratio	1.39:1 to 2.23:1				
Light source		Laser diode			High pressure mercury lamp 370 W type	High pressure mercury lamp 280 W type
Recommended lamp replacement time*2		—			3,000 H / 4,000 H (Lamp mode: High / Standard)	
Filter cleaning / replacement cycle (Max.)*2		20,000 H (service maintenance)				
Screen size		40" to 600" (1.02 m to 15.24 m) (measured diagonally)				
Light output (Mode: High / Standard)		6,000 lm / 4,000 lm	5,000 lm / 3,500 lm	4100 lm / 3000 lm	6,000 lm / 4,400 lm	5,000 lm / 3,200 lm
Color light output (Mode: High / Standard)		6,000 lm / 4,000 lm	5,000 lm / 3,500 lm	4100 lm / 3000 lm	6,000 lm / 4,400 lm	5,000 lm / 3,200 lm
Contrast ratio*3 (full white / full black)		10,000:1			2,000:1	
Displayable scanning frequency	Horizontal	15kHz to 92kHz				
	Vertical	48Hz to 92Hz				
Display resolution	Computer signal input	Maximum display resolution: 1920 x 1200 dots*4				
	Video signal input	NTSC, PAL, SECAM, 480/60i, 576/50i, 480/60p, 576/50p, 720/60p, 720/50p, 1080/60i, 1080/50i The following items are available for digital signal only: 1080/60p, 1080/50p, 1080/24p				
Color system		NTSC3.58, PAL, SECAM, NTSC4.43, PAL-M, PAL-N, PAL60				
Keystone correction (Max.)		Vertical: +/- 30 degrees Horizontal: +/- 30 degrees				
OSD language		24-languages (English, Dutch, French, Italian, German, Spanish, Portuguese, Turkish, Polish, Russian, Swedish, Norwegian, Japanese, Simplified Chinese, Traditional Chinese, Korean, Thai, Vietnamese, Arabic, Farsi, Finnish, Indonesian, Hungarian, Greek)				
Computer and video signal input/output	INPUT A	RGB / Y Pb Pr input connector: Mini D-sub 15-pin (female), Audio input connector: Stereo mini jack				
	INPUT B	DVI input connector: DVI-D 24-pin (single link), HDCP support, Audio input connector: Shared with INPUT A				
	INPUT C	HDMI input connector: HDMI 19-pin, HDCP support, Audio input connector: HDMI audio support				
	INPUT D	HDBaseT interface connector: RJ45, 4 play (Video, Audio, LAN, Control)				
	VIDEO IN	Video input connector: BNC, Audio input connector: Shared with input A				
	OUTPUT A	Monitor output for Input A Connector: Mini D-sub 15-pin (female), Audio output connector: Stereo mini jack				
	OUTPUT B	Monitor output for Input B Connector: DVI-D 24-pin (single link), HDCP not supported, Audio output, Monitor out connector: Stereo mini jack				
Control signal input/output		RS-232C connector: D-sub 9-pin (male), LAN connector: RJ45, 10BASE-T / 100BASE-TX, IR (Control S) connector: Stereo mini jack, Plug in power DC 5 V				
Acoustic Noise (Mode: Standard)		28 dB				
Operating temperature (Operating humidity)		0°C to 40°C (32°F to 104°F) / 20% to 80% (no condensation)				
Storage temperature (Storage humidity)		-10°C to +60°C (14°F to +140°F) / 20% to 80% (no condensation)				
Power requirements		AC 100 V to 240 V, 5.5 A to 2.3 A, 50 Hz / 60 Hz	AC 100 V to 240 V, 4.5 A to 1.9 A, 50 Hz / 60 Hz	AC 100 V to 240 V, 5.5 A to 2.3 A, 50 Hz / 60 Hz	AC 100 V to 240 V, 5.0 A to 2.1 A, 50 Hz / 60 Hz	AC 100 V to 240 V, 4.3 A to 1.8 A, 50 Hz / 60 Hz
Power consumption (Mode: High / Standard)	AC 100 V to 120 V	509 W / 298 W	420 W / 272 W	370 W / 234 W	498 W / 346 W	429 W / 268 W
	AC 220 V to 240 V	492 W / 283 W	408 W / 266 W	355 W / 229 W	483 W / 337 W	416 W / 261 W
Power Consumption (Standby Mode)	AC 100 V to 120 V	0.5 W (when "Standby mode" is set to "Low")				
	AC 220 V to 240 V	0.5 W (when "Standby mode" is set to "Low")				
Power Consumption (Networked Standby Mode)	AC 100 V to 120 V	15.0 W (All terminals and networks connected, when "Standby Mode" is set to "Standard")				
	AC 220 V to 240 V	13.3 W (All terminals and networks connected, when "Standby Mode" is set to "Standard")				
Heat dissipation	AC 100 V to 120 V	1732 BTU/h	1433 BTU/h	1262 BTU/h	1699 BTU/h	1464 BTU/h
	AC 220 V to 240 V	1679 BTU/h	1393 BTU/h	1211 BTU/h	1648 BTU/h	1419 BTU/h
Outside dimensions		Approx. W 460 x H 169 x D 515 mm (W 18 1/8 x H 6 21/32 x D 20 9/32 in) (without protrusions)				
Mass		Approx. 1.6 kg (34 lb)			Approx. 13 kg (28 lb)	
Supplied accessories		RM-PJ27 Remote Commander (1), Size AA (R6) batteries (2), AC Power Cord (1), Plug holder (1), Terminal cover (1), Quick Reference Manual (1), Operating Instructions (CD-ROM) (1)				
Replacement lamp		—			LMP-F370	LMP-F280

*1 With supplied standard lens

*2 This figure is the expected maintenance time, not a guaranteed time.
The actual value depends on the environment and how the projector is used.

*3 The value is average.

*4 Available for VESA Reduced Blanking signal.

LASER NOTICES
IEC 60825-1:2007

IEC 60825-1:2014



CLASS 1 LASER PRODUCT
RISK GROUP 3 to IEC 62471:2006
Warning: Possibly hazardous optical radiation emitted from this product.



©2015 Sony Corporation. All rights reserved.

Reproduction in whole or in part without written permission is prohibited.
Features and specifications are subject to change without notice.

The values for mass and dimension are approximate.

"SONY", "Z-Phosphor", "BrightEra" and "Remote Commander" are trademarks of Sony Corporation.

Trademark PJLink is a trademark applied for trademark rights in Japan, the United States of America and other countries and areas.

The terms HDMI and HDMI High-Definition Multimedia Interface, and the HDMI Logo are trademarks or registered trademarks of HDMI Licensing LLC in the United States and other countries.

All other trademarks are the property of their respective owners.

HDBaseT™ and the HDBaseT Alliance logo are trademarks of the HDBaseT Alliance.