

# X1-4K/X2-4K

## Projector User Guide

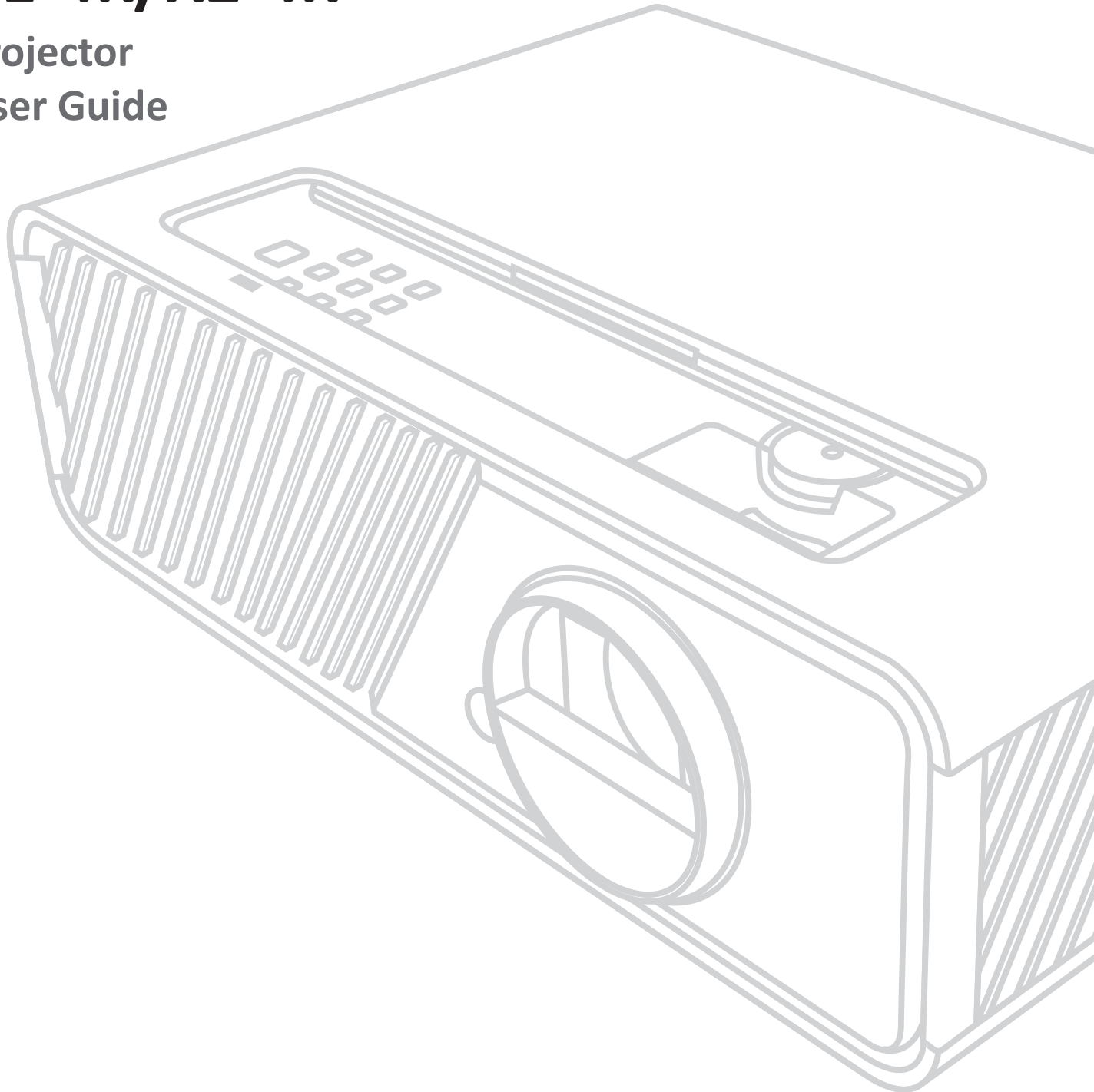

**IMPORTANT:** Please read this User Guide to obtain important information on installing and using your product in a safe manner, as well as registering your product for future service. Warranty information contained in this User Guide will describe your limited coverage from ViewSonic Corporation, which is also found on our web site at <http://www.viewsonic.com> in English, or in specific languages using the Regional selection box in the upper right corner of our website. "Antes de operar su equipo lea cuidadosamente las instrucciones en este manual"

Model No. VS19300/ VS19302

Model Name: X1-4K/X2-4K

## **Thank you for choosing ViewSonic®**

As a world-leading provider of visual solutions, ViewSonic® is dedicated to exceeding the world's expectations for technological evolution, innovation, and simplicity. At ViewSonic®, we believe that our products have the potential to make a positive impact in the world, and we are confident that the ViewSonic® product you have chosen will serve you well.

Once again, thank you for choosing ViewSonic®!

# Safety Precautions

Please read the following **Safety Precautions** before you start using the projector.

- Keep this user guide in a safe place for later reference.
- Read all warnings and follow all instructions.
- Allow at least 20" (50 cm) clearance around the projector to ensure proper ventilation.
- Place the projector in a well-ventilated area. Do not place anything on the projector that prevents heat dissipation.
- Do not place the projector on an uneven or unstable surface. The projector may fall over, causing personal injury or projector malfunction.
- Do not look straight at the projector lens during operation. The intense light beam may damage your eyes.
- Always open the lens shutter or remove the lens cap when the projector lamp is on.
- Do not block the projection lens with any objects when the projector is under operation as this could cause objects to become heated and deformed or even cause a fire.
- The lamp becomes extremely hot during operation. Allow the projector to cool for approximately 45 minutes prior to removing the lamp assembly for replacement.
- Do not use lamps beyond the rated lamp life. Excessive use of lamps beyond the rated life could cause them to break on rare occasions.
- Never replace the lamp assembly or any electronic component unless the projector is unplugged.
- Do not attempt to disassemble the projector. There are dangerous high voltages inside which may cause death if you should come into contact with live parts.
- When moving the projector, be careful not to drop or bump the projector on anything.
- Do not place any heavy objects on the projector or connection cables.
- Do not stand the projector on end vertically. Doing so may cause the projector to fall over, causing personal injury or projector malfunction.
- Avoid exposing the projector to direct sunlight or other sources of sustained heat. Do not install near any heat sources such as radiators, heat registers, stoves, or other devices (including amplifiers) that may increase the temperature of the projector to dangerous levels.

- Do not place liquids near or on the projector. Liquids spilled into the projector may cause it to fail. If the projector does become wet, disconnect it from the power supply and call your local service center to have the projector serviced.
- When the projector is under operation, you may sense some heated air and odor from its ventilation grill. It is a normal operation and not a defect.
- Do not attempt to circumvent the safety provisions of the polarized or grounding-type plug. A polarized plug has two blades with one wider than the other. A grounding-type plug has two blades and a third grounding prong. The wide and third blade are provided for your safety. If the plug does not fit into your outlet, obtain an adapter and do not attempt to force the plug into the outlet.
- When connecting to a power outlet, DO NOT remove the grounding prong. Please ensure grounding prongs are NEVER REMOVED.
- Protect the power cord from being treaded upon or pinched, particularly at the plug, and at the point where it emerges from the projector.
- In some countries, the voltage is NOT stable. This projector is designed to operate safely within a voltage between 100 to 240 volts AC, but could fail if power cuts or surges of  $\pm 10$  volts occur. In areas where voltage may fluctuate or cut out, it is recommended that you connect your projector through a power stabilizer, surge protector, or uninterruptable power supply (UPS).
- If smoke, an abnormal noise, or a strange odor is present, immediately switch the projector off and call your dealer or ViewSonic®. It is dangerous to continue using the projector.
- Use only attachments/accessories specified by the manufacturer.
- Disconnect the power cord from the AC outlet if the projector is not being used for a long period of time.
- Refer all servicing to qualified service personnel.



**CAUTION:** Possibly hazardous optical radiation is emitted from this product. As with any bright light source, do not stare into the beam, RG2 IEC 62471-5:2015

# Safety Precautions - Ceiling Mounting

Please read the following **Safety Precautions** before you start using the projector.

If you intend to mount the projector on the ceiling, it is strongly recommended that you use a proper fitting projector ceiling mount kit and that you ensure it is securely and safely installed.

If you use an inappropriate projector ceiling mount kit, there is a safety risk that the projector may fall from the ceiling due to an improper attachment through the use of the wrong gauge or length screws.

You can purchase a projector ceiling mount kit from the place you purchased your projector.

# Contents

<b>Introduction .....</b>	<b>9</b>
Package Contents .....	9
Product Overview .....	10
Projector.....	10
Controls and Functions .....	10
Connection Ports.....	11
Remote Control .....	12
Controls and Functions .....	12
Remote Control Effective Range .....	13
Replacing the Remote Control Batteries.....	14
<b>Initial Setup.....</b>	<b>15</b>
Choosing a Location.....	15
Projection Dimensions.....	16
16:9 Image on a 16:9 Screen.....	16
X1-4K.....	16
X2-4K.....	17
16:9 Image on a 4:3 Screen.....	17
X1-4K.....	17
X2-4K.....	18
Mounting the Projector .....	19
Preventing Unauthorized Use.....	20
Using the Security Slot .....	20
Using the Password Function .....	21
Setting a Password.....	21
Changing the Password.....	22
Disabling the Password Function .....	22
Forgetting the Password .....	23
Password Recall Procedure.....	23
Locking the Control Keys.....	24
<b>Making Connections.....</b>	<b>25</b>
Connecting to Power .....	25
Connecting to Video/Computer Sources.....	26
HDMI Connection.....	26
USB C Connection.....	26
Connecting to Audio .....	26

<b>Operation.....</b>	<b>28</b>
Turning the Projector On/Off .....	28
Starting Up the Projector .....	28
First Time Activation .....	28
WiFi Settings .....	29
Bluetooth Remote Control Settings .....	30
Shutting Down the Projector.....	31
Selecting an Input Source .....	32
Adjusting the Projected Image .....	33
Adjusting the Projector's Height and Projection Angle.....	33
Fine-Tuning the Image Size and Clarity .....	33
Correcting Keystone .....	34
Adjusting 4 corners .....	35
Hiding the Image .....	35
<b>Menu Functions .....</b>	<b>36</b>
General On-Screen Display (OSD) Menu Operation .....	36
On-Screen Display (OSD) Menu Tree.....	37
DISPLAY Menu .....	42
IMAGE Menu .....	45
POWER MANAGEMENT Menu .....	48
BASIC Menu .....	50
ADVANCED Menu .....	53
SYSTEM Menu.....	57
INFORMATION Menu .....	59
<b>Smart System .....</b>	<b>60</b>
Home Screen .....	60
Home Screen - On-Screen Display (OSD) Menu Tree .....	61
Menu Operations .....	63

<b>Appendix.....</b>	<b>89</b>
Specifications.....	89
Projector Dimensions.....	90
Timing Chart.....	91
Troubleshooting.....	93
Common Problems.....	93
LED Indicator.....	94
Maintenance.....	95
General Precautions.....	95
Cleaning the Lens.....	95
Cleaning the Case.....	95
Storing the Projector.....	95
Disclaimer.....	95
Light Source Information.....	96
Light Source Hour.....	96
Extending Light Source Life.....	96



# Introduction

## Package Contents

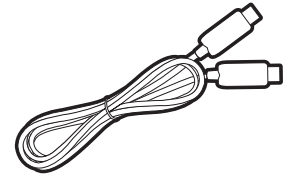
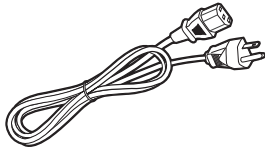
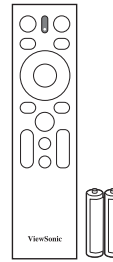
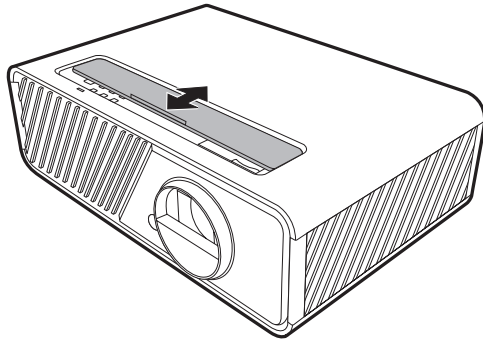

**NOTE:** The power cord and video cables included in your package may vary depending on your country. Please contact your local reseller for more information.

# Product Overview

## Projector

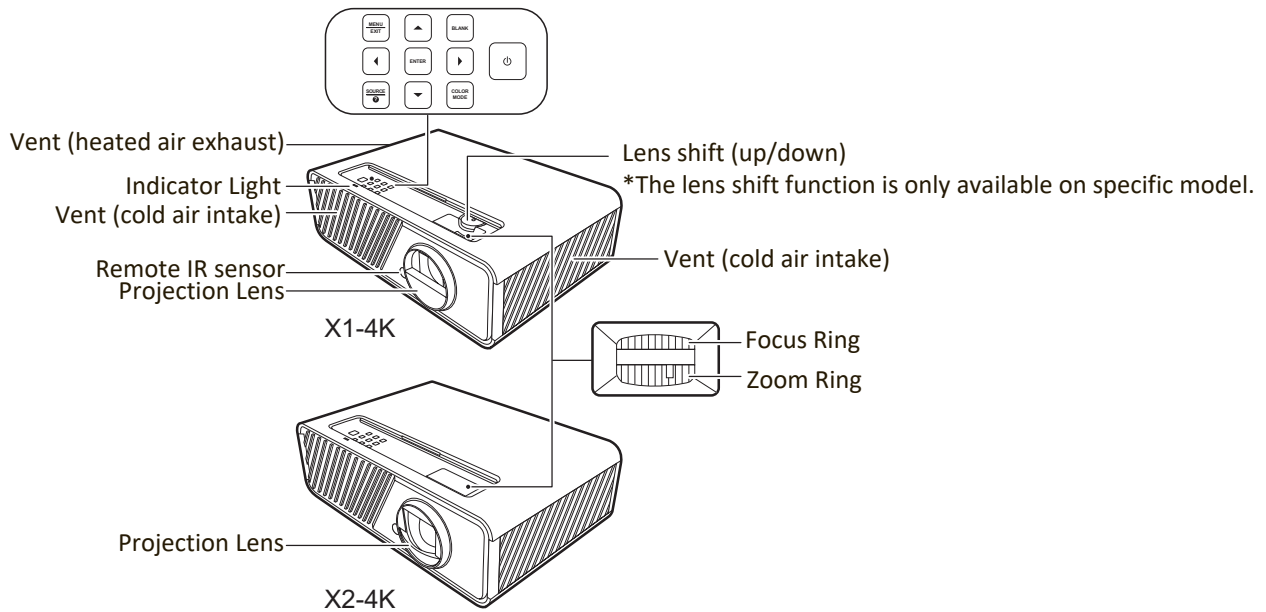

## Controls and Functions

Key	Description
[⏻] Power	Toggles the projector between standby mode and Power On.
MENU	<ul style="list-style-type: none"> <li>Turns on or off the On-Screen Display (OSD) Menu.</li> <li>Goes back to previous OSD menu, exits and saves menu settings.</li> </ul>
EXIT	
[◀/▶/▲/▼] Left/Right/Up/Down	<p>When the input source is SMART SYSTEM</p> <p>Moves through the menu items or toggle through the available options.</p> <p>When the input source is not SMART SYSTEM</p> <ul style="list-style-type: none"> <li>Manually corrects distorted images resulting from an angled projection.</li> <li>Selects the desired menu items and makes adjustments when the On-Screen Display (OSD) Menu is activated.</li> </ul>
SOURCE	<ul style="list-style-type: none"> <li>Displays the input source selection bar.</li> <li>Displays the HELP menu by a long press for 3 seconds.</li> </ul>
BLANK	Hides the screen picture.
ENTER	<p>When the input source is SMART SYSTEM</p> <p>Confirms the selected menu item.</p> <p>When the input source is not SMART SYSTEM</p> <ul style="list-style-type: none"> <li>Displays the Corner Adj. menu.</li> <li>Enacts the selected On-Screen Display (OSD) Menu item when the OSD Menu is activated.</li> </ul>
COLOR MODE	Displays the color mode selection bar.

## Connection Ports

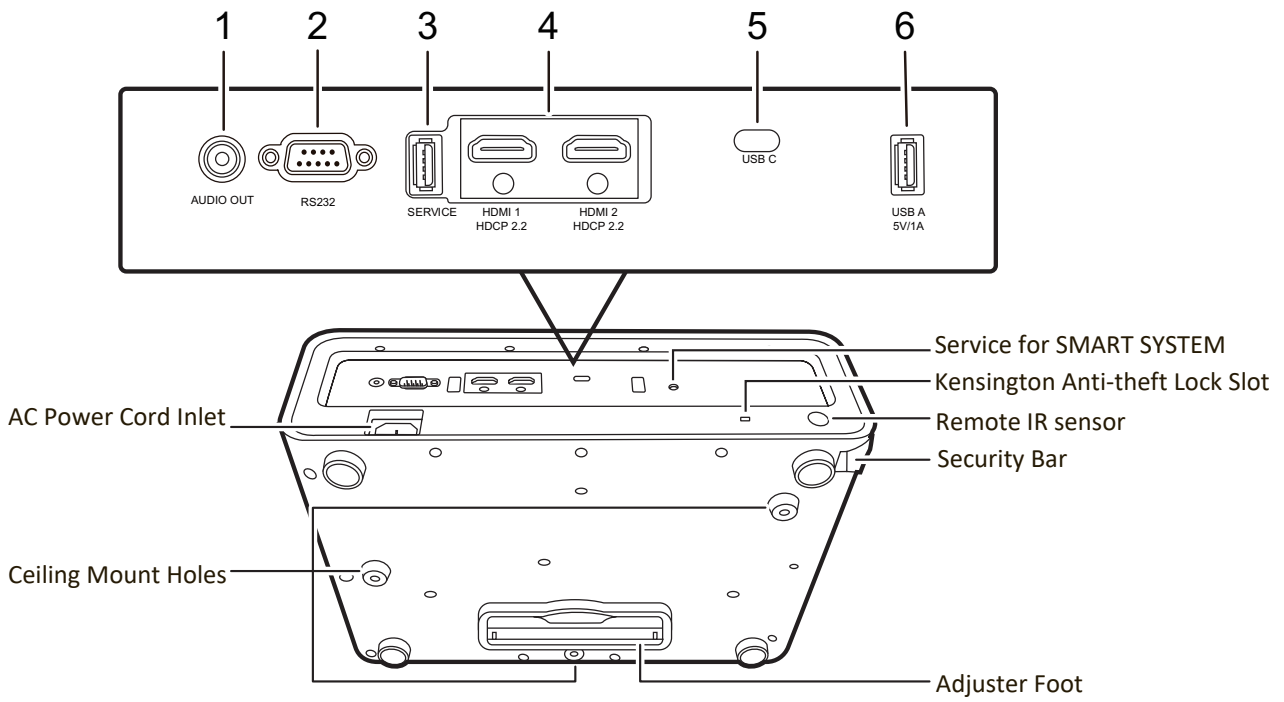

Port	Description
[1] AUDIO OUT	Audio signal output socket.
[2] RS-232	RS-232 control port.
[3] SERVICE	For service personnel only.
[4] HDMI 1, HDMI 2	HDMI ports.
[5] USB C	USB Type-C port.
[6] USB A 5V/1A OUT	USB Type A port for power supply.

# Remote Control

## Controls and Functions

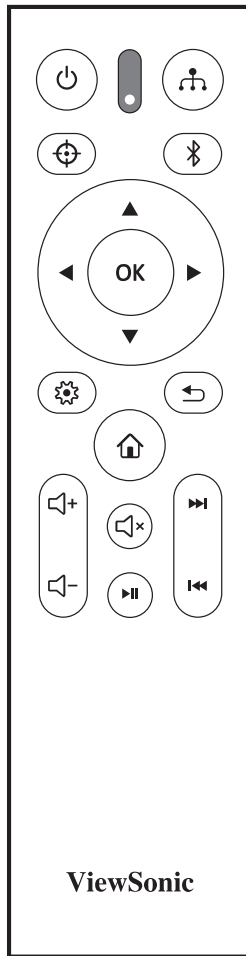









### When the input source is SMART SYSTEM

Button	Description
Power	Toggles between standby mode and Power On.
	Not available.
	Displays the source selection bar.
	Displays the Bluetooth menu.
Left/  Right Up/  Down	Selects the desired menu items and makes adjustments.
OK	Confirms the selected menu item.
	Turns on/off the On-Screen Display (OSD) Menu or goes back to previous OSD Menu.

Button	Description
	Returns to the previous menu, main settings menu or exit the app.
	Goes to the homepage of the SMART SYSTEM.
	Increases the projector volume.
	Decreases the projector volume.
	Mutes or unmutes the projector volume.
	Plays or pauses the playback of a file.
	Fast forwards the file or goes to the next one.
	Rewinds the file or goes to the previous one.

### When the input source is not SMART SYSTEM

Button	Description
Power	Toggles between standby mode and Power On.
	Not available.
	Displays the source selection bar.
	Not available.
Left/  Right Up/  Down	<ul style="list-style-type: none"> <li>Manually corrects distorted images resulting from an angled projection.</li> <li>Selects the desired menu items and makes adjustments when the On-Screen Display (OSD) Menu is activated.</li> </ul>
OK	Confirms the selected menu item.
	Turns on/off the On-Screen Display (OSD) Menu or goes back to previous OSD Menu.

Button	Description
	Exits and saves menu settings.
	Goes to the homepage of the SMART SYSTEM.
	Increases the projector volume.
	Decreases the projector volume.
	Mutes or unmutes the projector volume.
	Not available.
	
	

### Remote Control Effective Range

To ensure proper function of the remote control follow the steps below:

1. The remote control must be held at an angle within 30° perpendicular to the projector's IR remote control sensor(s).
2. The distance between the remote control and the sensor(s) should not exceed 8 m (26 ft.)

**NOTE:** Refer to the illustration for the location of the infrared (IR) remote control sensor(s).

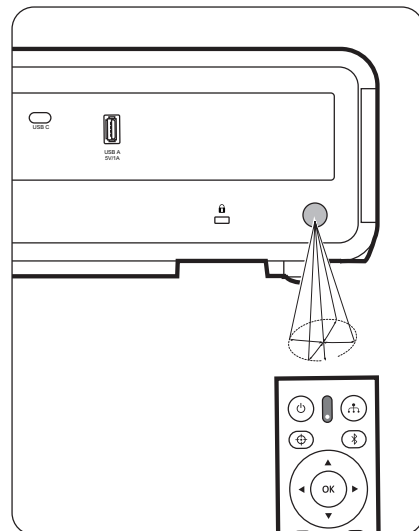
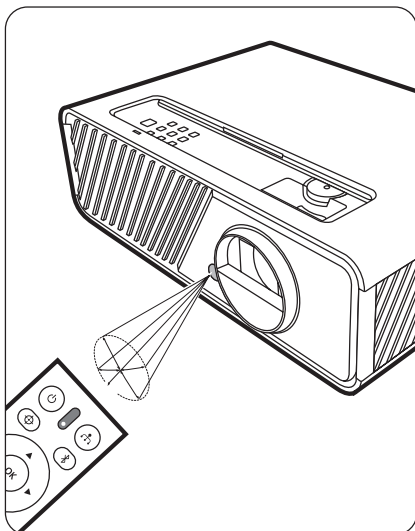

## Replacing the Remote Control Batteries

1. Remove the battery cover from the rear of the remote control by pressing the finger grip and sliding it down.
2. Remove any existing batteries (if necessary) and install two AAA batteries.

**NOTE:** Observe the battery's polarities as indicated.

3. Replace the battery cover by aligning it with the base and pushing it back into position.

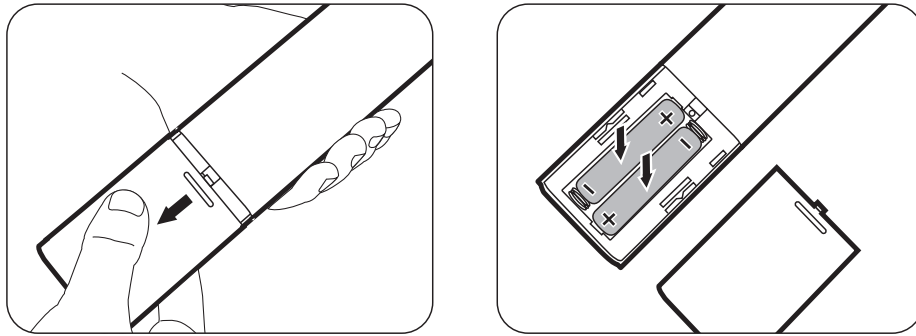

### NOTE:

- Avoid leaving the remote control and batteries in excessive heat or a humid environment.
- Replace only with the same or equivalent type recommended by the battery manufacturer.
- Dispose of the used batteries according to the manufacturer's instructions and local environment regulations for your region.
- If the batteries are drained or if you will not be using the remote control for an extended period of time, remove the batteries to avoid damage to the remote control.

# Initial Setup

This section provides detailed instructions for setting up your projector.

## Choosing a Location

Personal preference and room layout will decide the installation location. Consider the following:

- Size and Position of your screen.
- Location of a suitable power outlet.
- Location and Distance between the projector and other equipment.

The projector is designed to be installed in one of the following locations:

### 1. Front

The projector is placed near the floor in front of the screen.

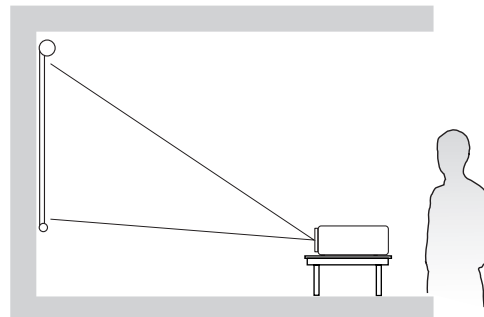

### 2. Front Ceiling

The projector is suspended upside-down from the ceiling in front of the screen.

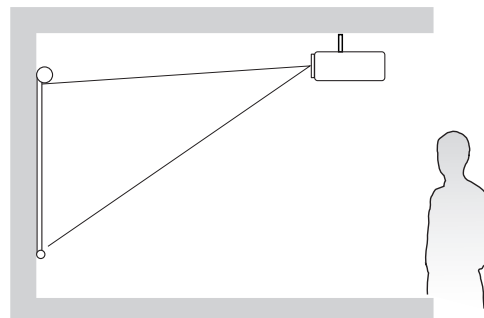

### 3. Rear Ceiling

The projector is suspended upside-down from the ceiling behind the screen.

**NOTE:** A special rear projection screen is required.

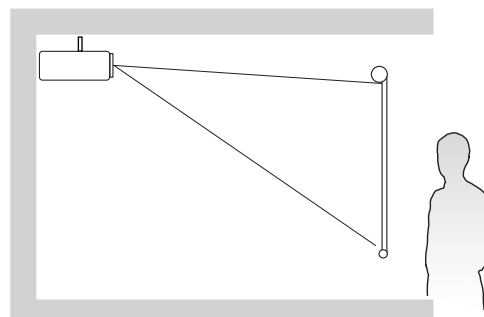

### 4. Rear

The projector is placed near the floor behind the screen.

**NOTE:** A special rear projection screen is required.

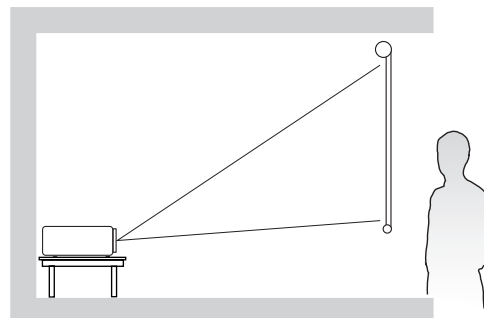

# Projection Dimensions

**NOTE:** See “Specifications” on page 89 for the native display resolution of this projector.

- **16:9 Image on a 16:9 Screen**

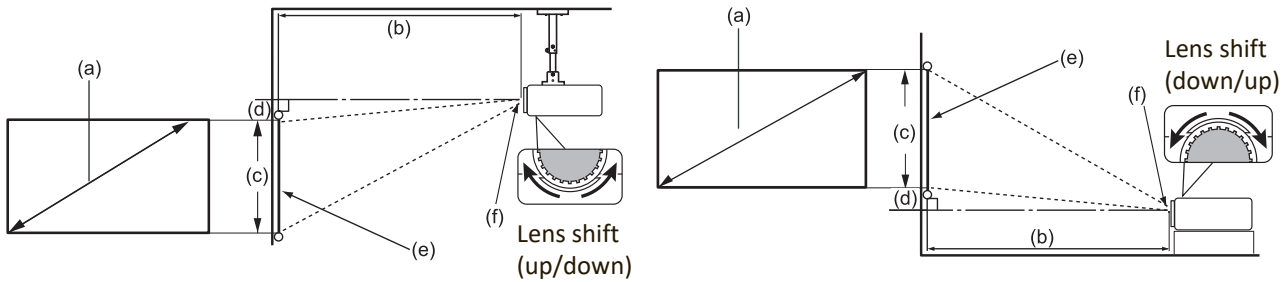

- **16:9 Image on a 4:3 Screen**

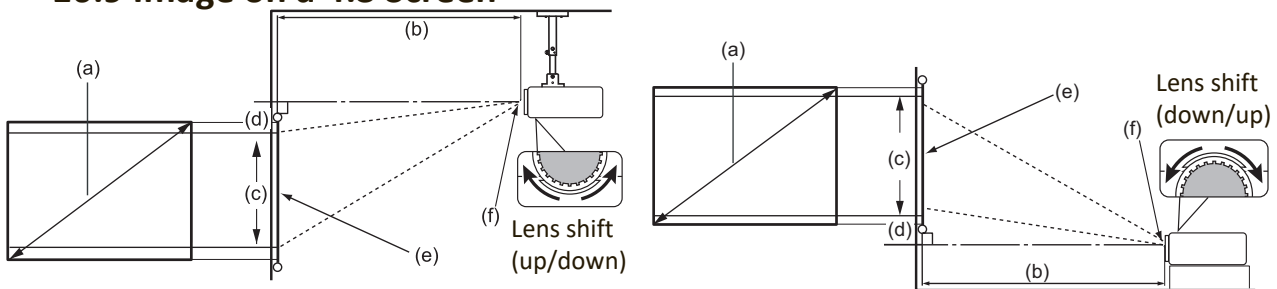

**NOTE:** (e) = Screen  
 (f) = Center of Lens  
 The Lens shift function is only available on X1-4K.

- **16:9 Image on a 16:9 Screen**

## X1-4K

(a) Screen Size		(b) Projection Distance				(c) Image Height		(d) Vertical Offset			
inch	mm	inch	mm	inch	mm	inch	mm	inch	mm	inch	mm
60	1524	60	1522	78	1979	29	747	1.5	37	4.4	112
70	1778	70	1776	91	2309	34	872	1.7	44	5.1	131
80	2032	80	2029	104	2638	39	996	2.0	50	5.9	149
90	2286	90	2283	117	2968	44	1121	2.2	56	6.6	168
100	2540	100	2537	130	3298	49	1245	2.5	62	7.4	187
110	2794	110	2791	143	3628	54	1370	2.7	68	8.1	205
120	3048	120	3044	156	3957	59	1494	2.9	75	8.8	224
130	3302	130	3298	169	4287	64	1619	3.2	81	9.6	243
140	3556	140	3552	182	4617	69	1743	3.4	87	10.3	262
150	3810	150	3805	195	4947	74	1868	3.7	93	11.0	280



## X2-4K

(a) Screen Size		(b) Projection Distance				(c) Image Height		(d) Vertical Offset			
		minimum		maximum				minimum		maximum	
inch	mm	inch	mm	inch	mm	inch	mm	inch	mm	inch	mm
60	1524	36	909	43	1091	29	747	0.7	19	0.7	19
70	1778	42	1061	50	1273	34	872	0.9	22	0.9	22
80	2032	48	1213	57	1455	39	996	1.0	25	1.0	25
90	2286	54	1364	64	1637	44	1121	1.1	28	1.1	28
100	2540	60	1516	72	1819	49	1245	1.2	31	1.2	31
110	2794	66	1667	79	2001	54	1370	1.3	34	1.3	34
120	3048	72	1819	86	2183	59	1494	1.5	37	1.5	37

- 16:9 Image on a 4:3 Screen

## X1-4K

(a) Screen Size		(b) Projection Distance				(c) Image Height		(d) Vertical Offset			
		minimum		maximum				minimum		maximum	
inch	mm	inch	mm	inch	mm	inch	mm	inch	mm	inch	mm
60	1524	55	1397	72	1816	27	686	1	34	4	103
70	1778	64	1630	83	2119	32	800	2	40	5	120
80	2032	73	1863	95	2422	36	914	2	46	5	137
90	2286	83	2096	107	2724	41	1029	2	51	6	154
100	2540	92	2329	119	3027	45	1143	2	57	7	171
110	2794	101	2561	131	3330	50	1257	2	63	7	189
120	3048	110	2794	143	3632	54	1372	3	69	8	206
130	3302	119	3027	155	3935	59	1486	3	74	9	223
140	3556	128	3260	167	4238	63	1600	3	80	9	240
150	3810	138	3493	179	4541	68	1715	3	86	10	257

**X2-4K**

(a) Screen Size		(b) Projection Distance				(c) Image Height		(d) Vertical Offset			
		minimum		maximum				minimum		maximum	
inch	mm	inch	mm	inch	mm	inch	mm	inch	mm	inch	mm
60	1524	33	835	39	1002	27	686	1	17	1	17
70	1778	38	974	46	1169	32	800	1	20	1	20
80	2032	44	1113	53	1336	36	914	1	23	1	23
90	2286	49	1252	59	1503	41	1029	1	26	1	26
100	2540	55	1391	66	1670	45	1143	1	29	1	29
110	2794	60	1530	72	1837	50	1257	1	31	1	31
120	3048	66	1670	79	2003	54	1372	1	34	1	34

**NOTE:** It is recommended that if you intend to permanently install the projector, please physically test the projection size and distance using the actual projector in situ before you permanently install it.

## Mounting the Projector

**NOTE:** If you buy a third-party mount, please use the correct screw size. Screw size can vary depending on the thickness of the mounting plate.

1. To ensure the most secure installation, please use a ViewSonic® wall or ceiling mount.
2. Ensure the screws used to attach a mount to the projector meet the following specifications:
  - Screw type: M4 x 8
  - Maximum Screw length: 8 mm

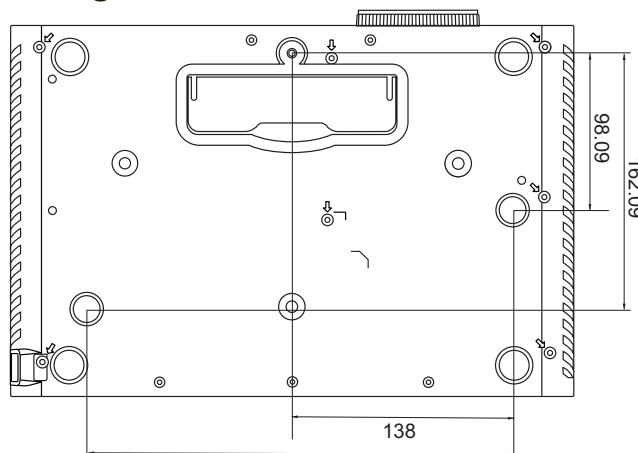

**NOTE:**

- Avoid installing the projector near a heat source.
- Keep at least a 10 cm gap between the ceiling and the bottom of the projector.

## Preventing Unauthorized Use

The projector has several built-in security features to prevent theft, access, or accidental setting changes.

### Using the Security Slot

To help prevent the projector from being stolen, use a security slot locking device to secure the projector to a fixed object.

Below is an example of setting up a security slot locking device:

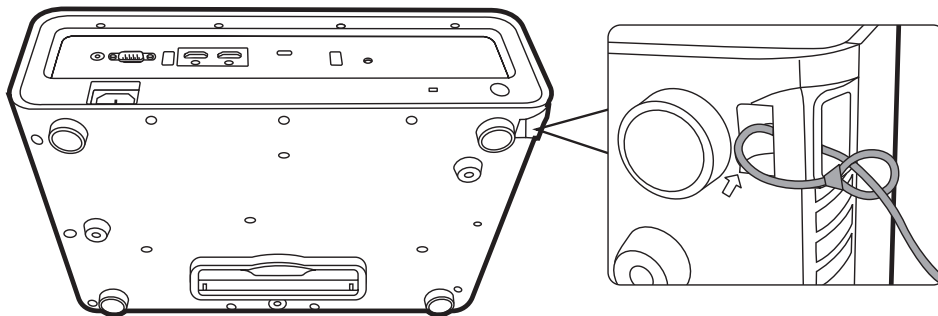

**NOTE:** The security slot can also be used as a safety anchor if the projector is mounted to the ceiling.

## Using the Password Function

To help prevent unauthorized access or use, the projector offers a password security option. The password can be set through the On-Screen Display (OSD) Menu.

**NOTE:** Make note of your password, and keep it in a safe place.

### Setting a Password



1. Press **MENU** or  to open the OSD Menu and go to: **SYSTEM > Security Settings** and press **ENTER/OK**.
2. Highlight **Power On Lock** and select **On** by pressing **◀/▶**.
3. As pictured to the right, the four arrow keys (**▲**, **▶**, **▼**, **◀**) represent 4 digits (1, 2, 3, 4). Press the arrow keys to enter a six digit password.



4. Confirm the new password by re-entering the new password. Once the password is set, the OSD Menu will return to the **Security Settings** page.
5. Press **EXIT** or  to leave the OSD Menu.



**NOTE:** Once set, the correct password must be entered every time the projector is started.

## Changing the Password

1. Press **MENU** or  to open the OSD Menu and go to: **SYSTEM > Security Settings > Change Password**.
2. Press **ENTER/OK**, the message, 'INPUT CURRENT PASSWORD' will appear.
3. Enter the old password.
  - » If the password is correct, the message, 'INPUT NEW PASSWORD' will appear.
  - » If the password is incorrect, a password error message will appear for 5 seconds followed by the message, 'INPUT CURRENT PASSWORD'. You can try again or press **EXIT** or  to cancel.
4. Enter a new password.
5. Confirm the new password by re-entering the new password.
6. To leave the OSD Menu, press **EXIT** or .

**NOTE:** The digits being input will display as asterisks(\*).

## Disabling the Password Function

1. Press **MENU** or  to open the OSD Menu and go to: **SYSTEM > Security Settings > Power On Lock**.
2. Press **◀/▶** to select **Off**.
3. The message, "Input Password" will appear. Enter the current password.
  - » If the password is correct, the OSD Menu returns to the Password page with "**Off**" shown in the row of **Power On Lock**.
  - » If the password is incorrect, a password error message will appear for 5 seconds followed by the message, 'INPUT CURRENT PASSWORD'. You can try again or press **EXIT** or  to cancel.

**NOTE:** Please keep the old password, as you will need it to reactivate the password function.

## Forgetting the Password

If the password function is activated, you will be asked to enter the six-digit password every time you turn on the projector. If you enter the wrong password, the password error message, as pictured to the right, will appear for 5 seconds, and the message 'INPUT PASSWORD' follows.

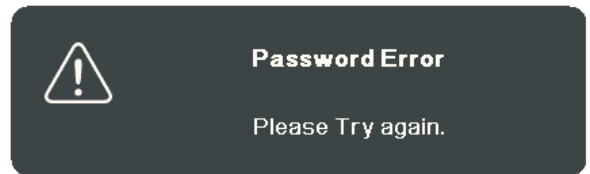

You can retry or if you do not remember, you can use the "Password Recall Procedure".

**NOTE:** If you enter an incorrect password 5 times in succession, the projector will automatically shut down for a short time.

## Password Recall Procedure

1. When the message 'INPUT CURRENT PASSWORD' appears, press and hold **ENTER/OK** for 3 seconds. The projector will display a coded number on the screen.
2. Write down the number and turn off your projector.
3. Seek help from the local service center to decode the number. You may be required to provide proof of purchase documentation to verify that you are an authorized user of the projector.

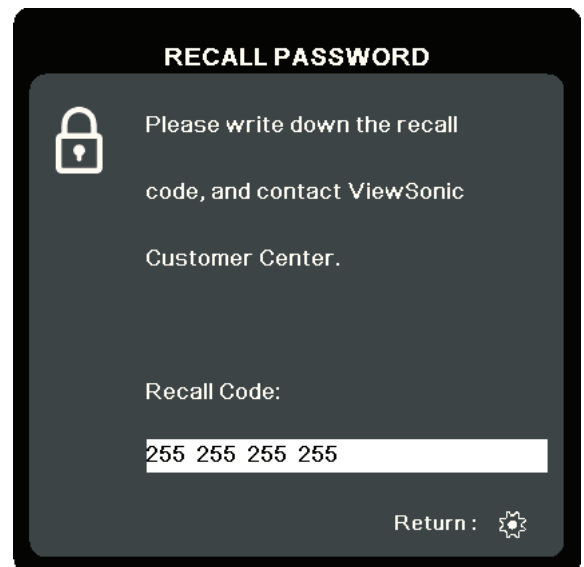

## Locking the Control Keys

With the control keys on the projector locked, you can prevent your settings from being changed accidentally (by children, for example).

**NOTE:** When the **Panel Key Lock** is On, no control keys on the projector will operate except **Power**.

1. Press **MENU** or  to open the OSD Menu and go to: **SYSTEM > Panel Key Lock**.
2. Press **▲/▼** to select **On**.
3. Select **Yes** and press **ENTER/OK** to confirm.
4. To release panel key lock, press and hold **▶** on the projector for 3 seconds.

**NOTE:** You can also use the remote control to enter the **SYSTEM > Panel Key Lock** menu and select **Off**.



# Making Connections

This section guides you on how to connect the projector with other equipment.

## Connecting to Power

1. Connect the power cord to the AC IN jack at the rear of the projector.
2. Plug the power cord into a power outlet.

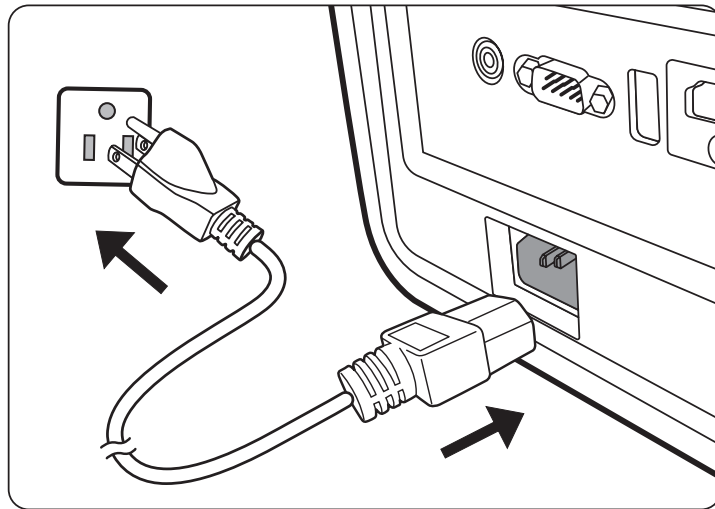

**NOTE:** When installing the projector, incorporate a readily accessible disconnect device in the fixed wiring, or connect the power plug to an easily accessible outlet near the unit. If a fault should occur during operation of the projector, use the disconnect device to switch off the power supply, or disconnect the power plug.

# Connecting to Video/Computer Sources

## HDMI Connection

Connect one end of an HDMI cable to the HDMI port of your video/computer device. Then connect the other end of the cable to the **HDMI** port of your projector.

## USB C Connection

Connect one end of an USB C cable to the USB C port of your video/computer device. Then connect the other end of the cable to the **USB C** port of your projector.

## Connecting to Audio

The projector is equipped with speakers, however, you can also connect external speakers to the **AUDIO OUT** port of the projector.

**NOTE:** The audio output is controlled by the remote control and the projector's **Volume** and **Mute** settings.

The connection illustrations below are for reference only. The connecting jacks available on the projector vary with each projector model. Some cables may not be included with the projector. They are commercially available from electronics stores.

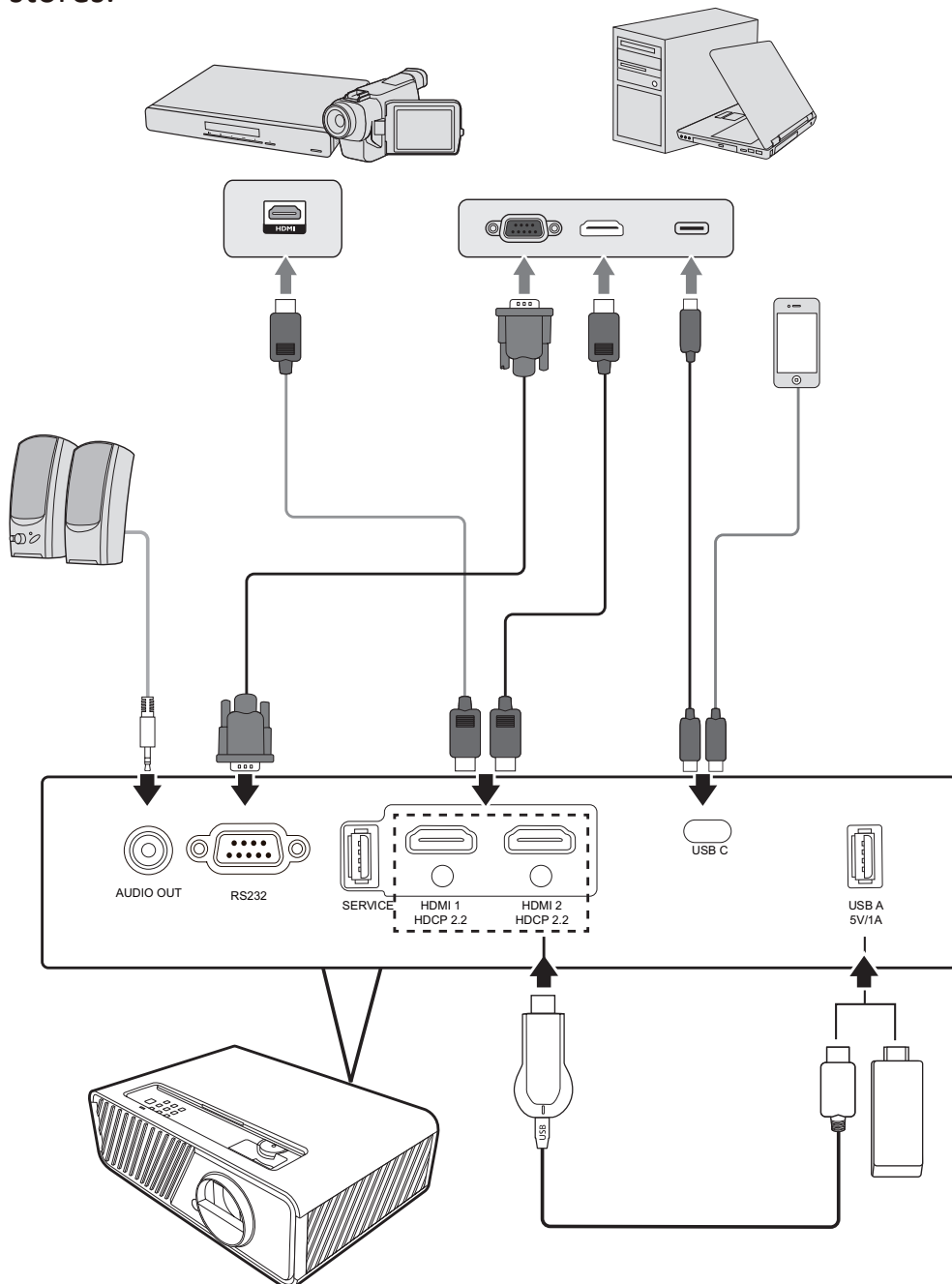

# Operation

## Turning the Projector On/Off

### Starting Up the Projector

1. Press the **Power** button to turn on the projector.
2. The light source will light up, and a **“Power On/Off Ring Tone”** will play.
3. The Power Indicator Light stays green when the projector is On.

#### NOTE:

- If the projector is still hot from previous use, it will run the cooling fan for 90 seconds before activating the light source.
  - To maintain light source life, once you turn the projector On, wait at least five (5) minutes before turning it off.
4. Turn on all of the connected equipment, i.e. notebook, and the projector will start to search for an input source.

**NOTE:** If the projector detects an input source, the Source Selection Bar will appear. If an input source is not detected, the message, ‘No Signal’ will appear.

### First Time Activation

If the projector is activated for the first time, pair the bluetooth remote control, select the projector position, WiFi settings and OSD language following the on-screen instructions.

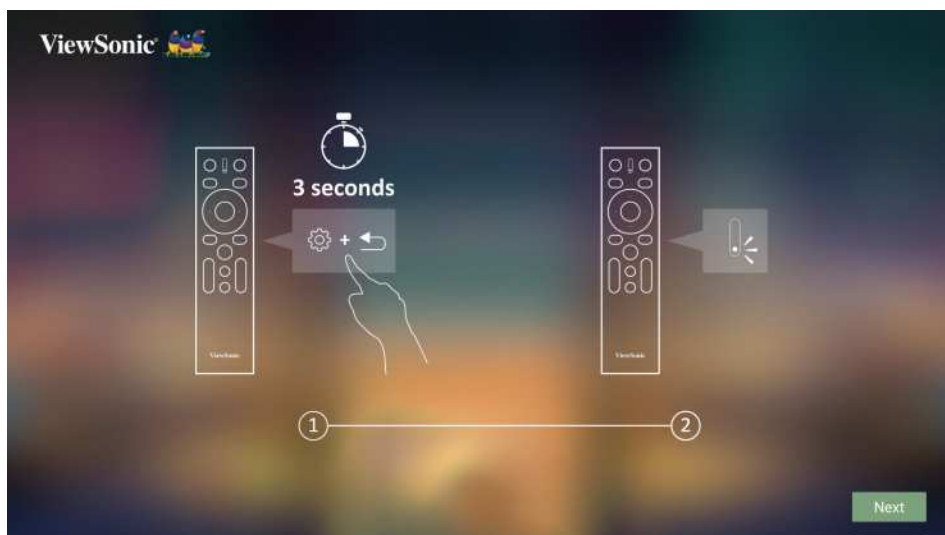

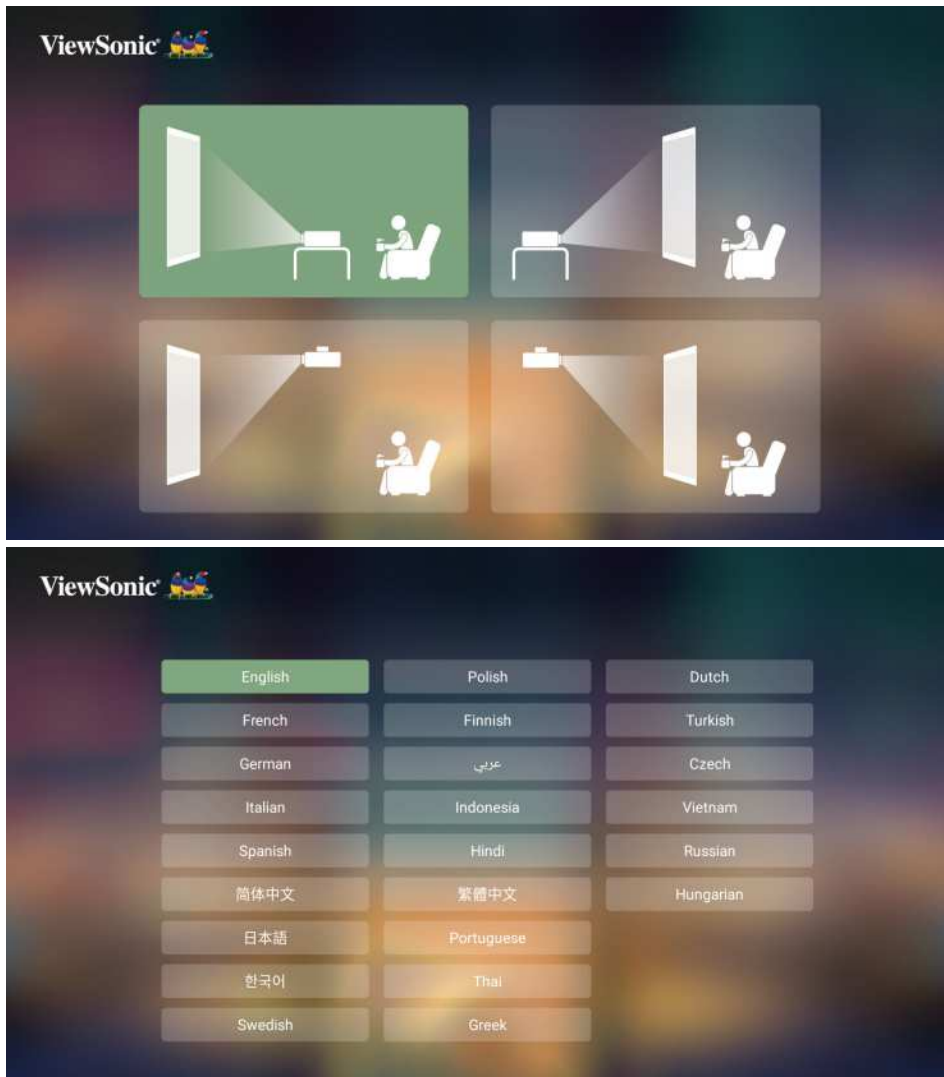



## WiFi Settings

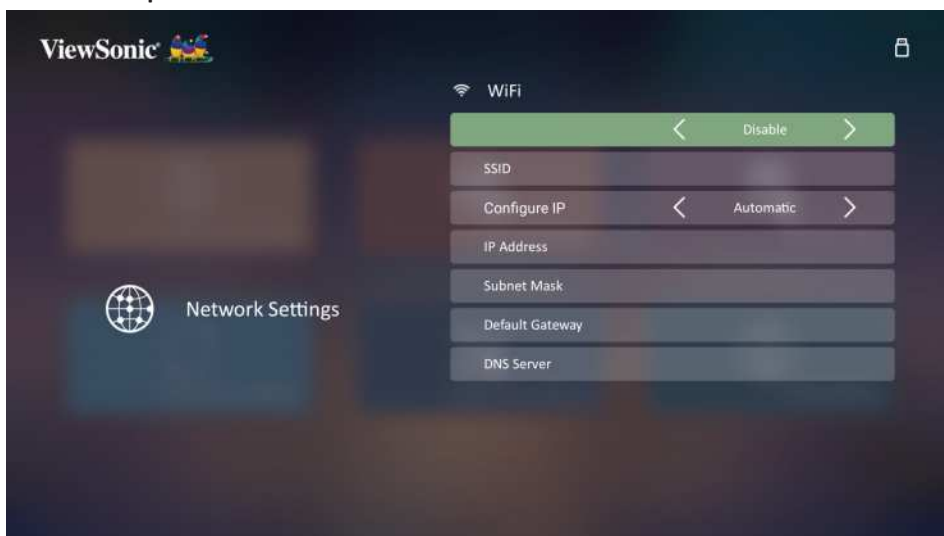

1. If the projector is activated for the first time, you can directly select the network name that you want to connect to and input the password in the WiFi settings page from the setup wizard.

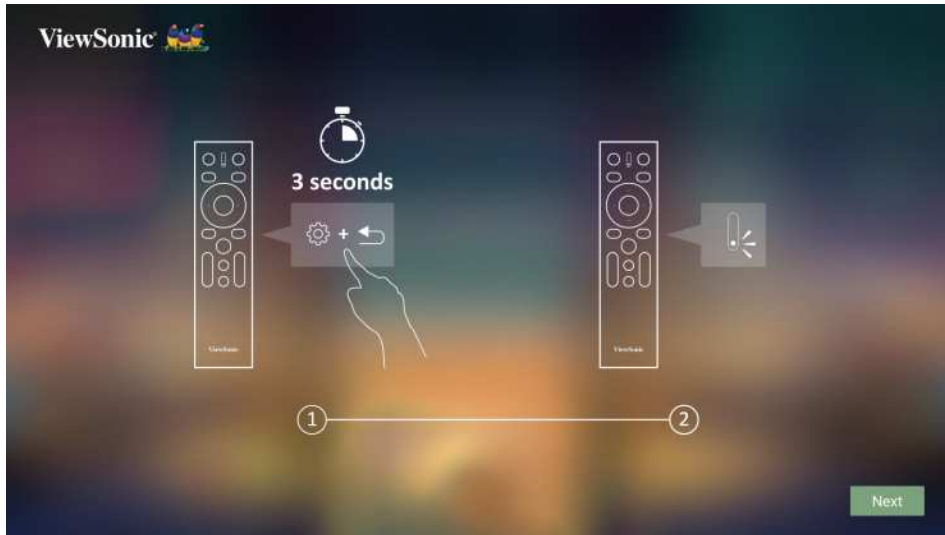

## Bluetooth Remote Control Settings

1. Pair the remote control with the projector following the illustrations from the setup wizard if the projector is activated for the first time.
  - Press and hold  and  together until the indicator on the remote control blinks blue.
  - A popup message will appear when the pairing is successful.



2. Or you can pair it in the Bluetooth Out page.
  - Press and hold  and  together until the indicator on the remote control blinks blue.
  - Select the device named "VIEWSONIC".

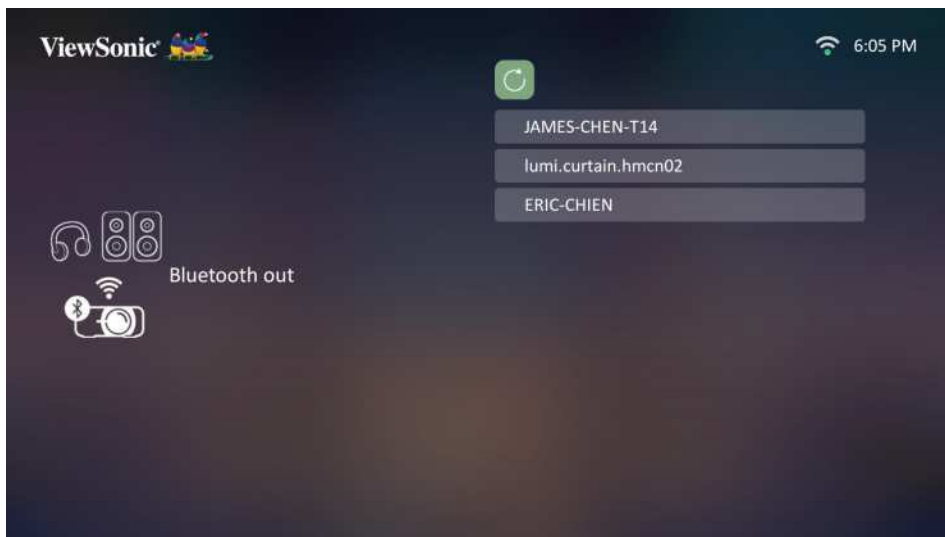

**NOTE:** The supplied remote control for ViewSonic **X1-4K/X2-4K** supports both bluetooth and infrared mode. The remote control and projector are in infrared mode when the indicator on the remote control lights up red. If the remote control is paired with the projector in bluetooth connection, the buttons and indicator on the remote control light up blue.

## Shutting Down the Projector

1. Press the **Power** or **Off** button and a confirmation message will appear to prompt you to press the **Power** or **Off** button a second time. Additionally you can press any other button to cancel.

**NOTE:** If you do not respond in a few seconds after the first press, the message will disappear.

2. Once the cooling process finishes, a **“Power On/Off Ring Tone”** will play.
3. Disconnect the power cord from the power outlet if the projector will not be used for an extended period of time.

### **NOTE:**

- To protect the light source, the projector will not respond to commands during the cooling process.
- Do not unplug the power cord before the projector completely shuts down.

## Selecting an Input Source

The projector can be connected to multiple devices at the same time. However, it can only display one full screen at a time.

If you want the projector to automatically search for the input source, ensure the **Quick Auto Search** function in the **SYSTEM** menu is **On**.

**NOTE:** If no input source is detected, the projector will go to **SMART SYSTEM**.

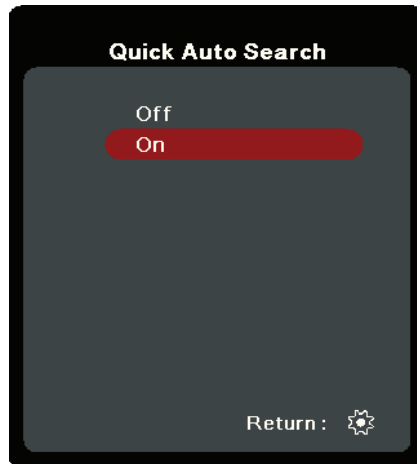

To manually select the input source do the following:

1. Press **SOURCE** or , and a source selection menu will appear.
2. Press **▲/▼** until your desired signal is selected and press **ENTER/OK**.
3. Once detected, the selected source information will be displayed on the screen for a few seconds.

**NOTE:** If there are multiple devices connected to the projector, repeat steps 1-2 to search for another source.



# Adjusting the Projected Image

## Adjusting the Projector's Height and Projection Angle

The projector is equipped with one (1) adjuster foot. Adjusting the foot will change the projector's height and the vertical projection angle. Carefully adjust the foot to fine tune the projected image's position.

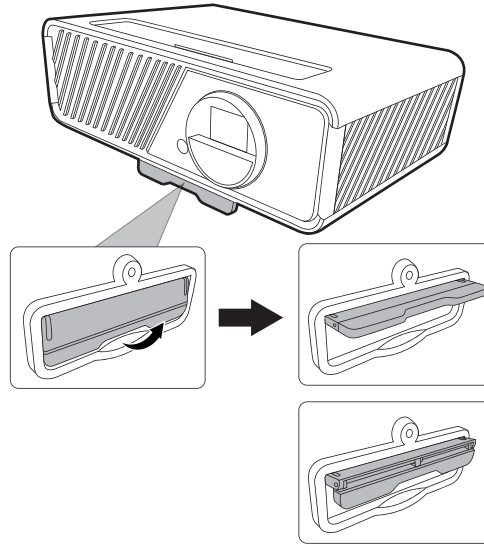

## Fine-Tuning the Image Size and Clarity

To adjust the projected image to the size that you need, rotate the Zoom Ring.

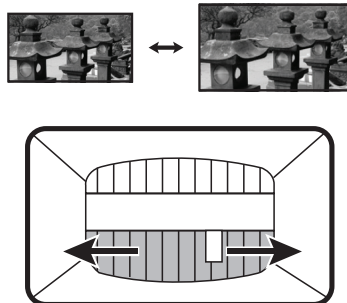

To improve the clarity of the image, rotate the Focus Ring.

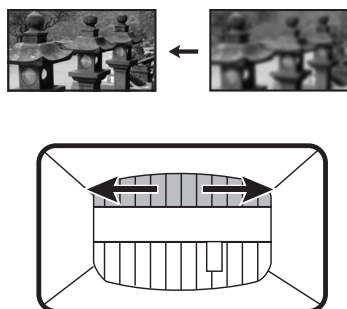

## Correcting Keystone

Keystoning refers to the situation where the projected image becomes a trapezoid due to angled projection.

To correct this, besides adjusting the height of the projector, you may also:

1. Use the **◀ Left / ▶ Right / ▲ Up / ▼ Down** keys on the projector or remote control to display the keystone page (when the input source is not **SMART SYSTEM**).
2. After the keystone page is displayed, press **▲ Up** to correct keystone at the top of the image. Press **▼ Down** to correct keystone at the bottom of the image. Press **▶ Right** to correct keystone at the right side of the image. Press **◀ Left** to correct keystone at the left side of the image.

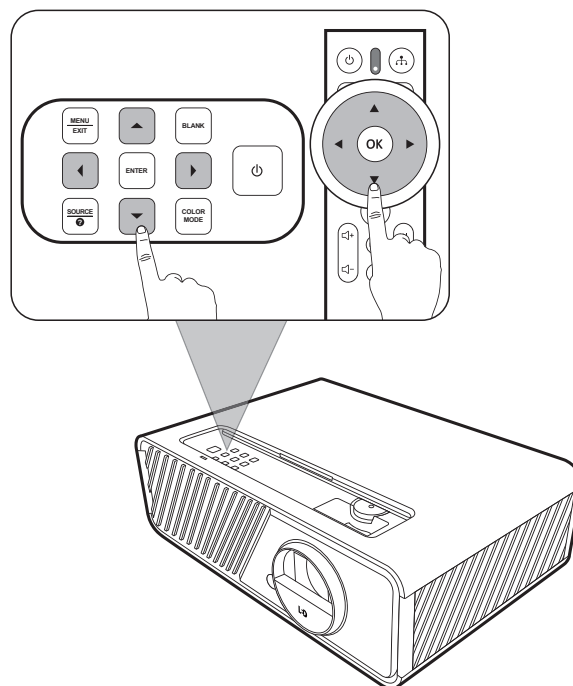
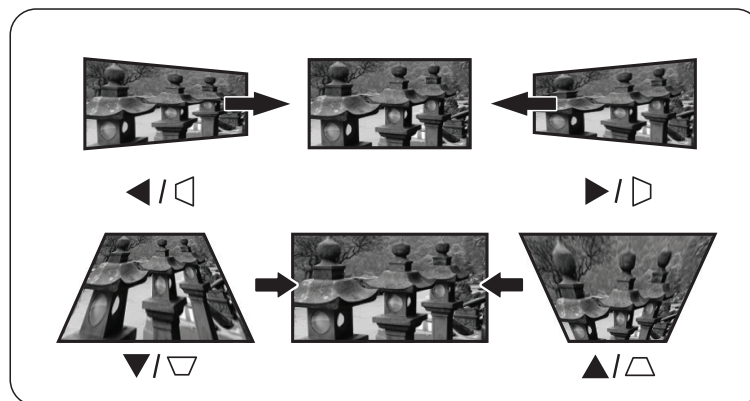

## Adjusting 4 corners

You can manually adjust the shape and size of an image that is unevenly rectangular on all sides.

1. To display the **Corner Adj.** page, you can do one of the followings:
  - Press **ENTER/OK** (when the input source is not **SMART SYSTEM**).
  - Open the OSD menu and go to the **DISPLAY > Corner Adj.** menu and press **Enter**. The **Corner Adj.** page is displayed.
2. Use **▲/▼/◀/▶** to select the corner you wish to adjust and press **ENTER/OK**.
3. Use **◀/▶** to select an adjustment method that suits your need and press **ENTER/OK**.
4. As indicated on the screen (**▲/▼** for a 45-degree angle adjustment and **▲/▼/◀/▶** for a 90-degree angle adjustment), press **▲/▼/◀/▶** to adjust its shape and size. You can press **Exit** or **⚙** to go back to a previous step. A long press for 2 seconds on **ENTER/OK** will reset the settings on the corner that you chose.

### NOTE:

- Adjusting keystone will reset the **Corner Adj.** settings.
- After the **Corner Adj.** settings have been modified, some aspect ratios or timings are not available. When that happens, reset the settings on all 4 corners.

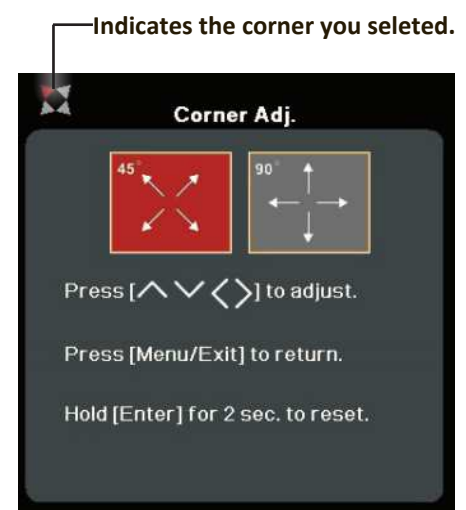
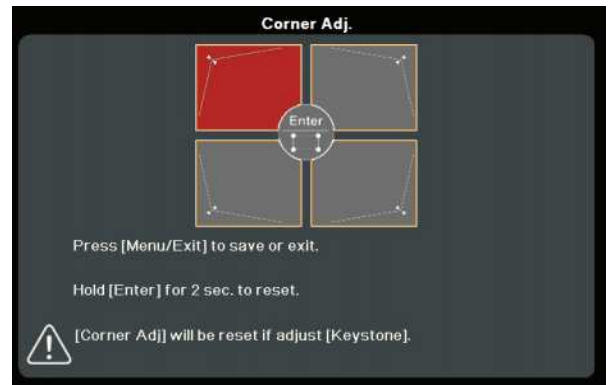

## Hiding the Image

In order to draw the audience's full attention to the presenter, you can press **BLANK** on the projector to hide the screen image. Press any key on the projector or remote control to restore the image.

**CAUTION:** Do not block the projection lens as this could cause the blocking object to become heated and deformed or even cause a fire.

# Menu Functions

This section will introduce the On-Screen Display (OSD) Menu and its options.

## General On-Screen Display (OSD) Menu Operation

**NOTE:** The OSD screenshots in this manual are for reference only and may differ from the actual design. Some of the following OSD settings may not be available. Please refer to the actual OSD of your projector.

The projector is equipped with an On-Screen Display (OSD) Menu for making various adjustments. It can be accessed by pressing **MENU** or  on the projector or remote control.

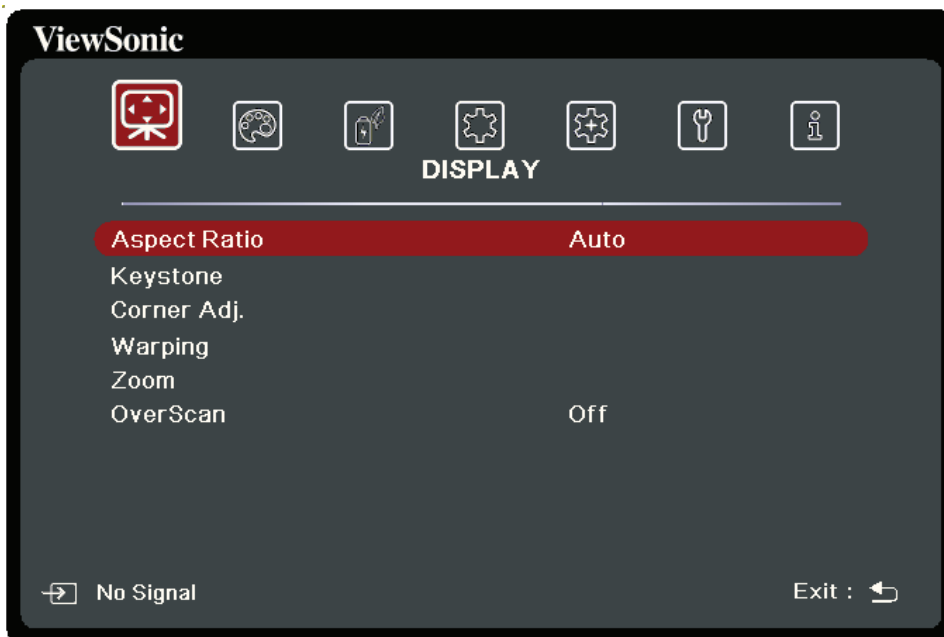

1. Press **◀/▶** to select a main menu. Then press **ENTER/OK** or use **▲/▼** to access the sub-menu list.
2. Press **▲/▼** to select the menu option. Then press **ENTER/OK** to display its sub-menu, or press **◀/▶** to adjust/select the setting.

**NOTE:** Some sub-menu options may have another sub-menu. To enter the respective sub-menu, press **ENTER/OK**. Use **▲/▼** or **◀/▶** to adjust/select the setting.

## On-Screen Display (OSD) Menu Tree

Main Menu	Sub-menu	Menu Option	
DISPLAY	Aspect Ratio	Auto	
		4:3	
		16:9	
		16:10	
		2.35:1	
		Native	
	Keystone	Auto V Keystone	Off/On
		Manual	Vertical
			Horizontal
			Rotation
	Corner Adj.	Top-Right	
		Top-Left	
		Bottom-Right	
		Bottom-Left	
	Warping	Enable	Off/On
		Control Method	OSD
			RS232
		Warping Adj.	
		Reset	
	Zoom	0.8X ~2.0X	
	OverScan	Off/1/2/3/4/5	

Main Menu	Sub-menu	Menu Option		
IMAGE	Color Mode	Brightest		
		TV		
		Gaming		
		Movie		
		User		
		Low Blue Light		
	Brightness	0~100		
	Contrast	-50~50		
	Color Temp.	9300K/7500K/6500K		
		Red Gain	0~100	
		Green Gain	0~100	
		Blue Gain	0~100	
		Red Offset	-50~+50	
		Green Offset	-50~+50	
		Blue Offset	-50~+50	
	Advanced	Color	-50~50	
		Sharpness	0~31	
		Gamma	1.8/2.0/2.2/2.35/ 2.5/Cubic/sRGB	
		Color Management	Primary Color	
			Hue	
			Saturation	
			Gain	
	Silence Mode	On		
		Off		
	Reset Color Settings	Reset		
		Cancel		





Main Menu	Sub-menu	Menu Option		
<b>POWER MANAGEMENT</b>	Auto Power On	Signal	Disable/Enable	
		CEC	Disable/Enable	
		Direct Power On	Disable/Enable	
	Smart Energy	Auto Power Off	Disable/10 min/20 min/30 min	
		Sleep Timer	Disable/30 min/1 hr/2hr/3 hr/4 hr/ 8 hr/12 hr	
		Power Saving	Disable/Enable	
	Power On Source	Disable/HDMI 1/HDMI 2/USB C		
<b>BASIC</b>	Audio Settings	Audio Mode	Music/Speech/Movie	
		Mute	Off/On	
		Audio Volume	0~20	
		Power On/Off Ring Tone	Off/On	
	Presentation Timer	Timer Period	1~240 m	
		Timer Display	Always/1 min/2 min/3 min/Never	
		Timer Position	Top-Left/Bottom-Left/Top-Right/Bottom-Right	
		Timer Counting Direction	Count Down/Count Up	
		Sound Reminder	Off/On	
		Start Counting/Off		
	Pattern	Off		
		Test Card		
	Message	Off		
		On		
	Splash Screen	Black		
		Blue		
		ViewSonic		

Main Menu	Sub-menu	Menu Option			
ADVANCED	HDR	HDR/HLG	Auto/SDR		
		EOTF	Low/Mid/High		
	3D Settings	3D Format	Auto		
			Off		
			Frame Sequential		
			Frame Packing		
			Top-Bottom		
			Side-by-Side		
		3D Sync Invert	Disable/Invert		
	Save 3D Settings	Yes/No			
	HDMI Settings	HDMI Format	Auto/RGB/YUV		
		HDMI Range	Auto/Enhanced/Normal		
	Ultra Fast Input	Inactive			
		Active			
	Light Source Settings	Light Source Mode	Normal/Eco/ Dynamic Black 1/ Dynamic Black 2/Custom		
		Light Source Power	20%~100%		
		Reset Light Source Hours	Reset/Cancel		
		Light Source Hours Information	Light Source Usage Time		
			Normal		
			Eco		
			Dynamic Black 1		
			Dynamic Black 2		
	Custom				
	Restart Smart System	Reset			
		Cancel			
	Reset Settings	Reset			
		Cancel			







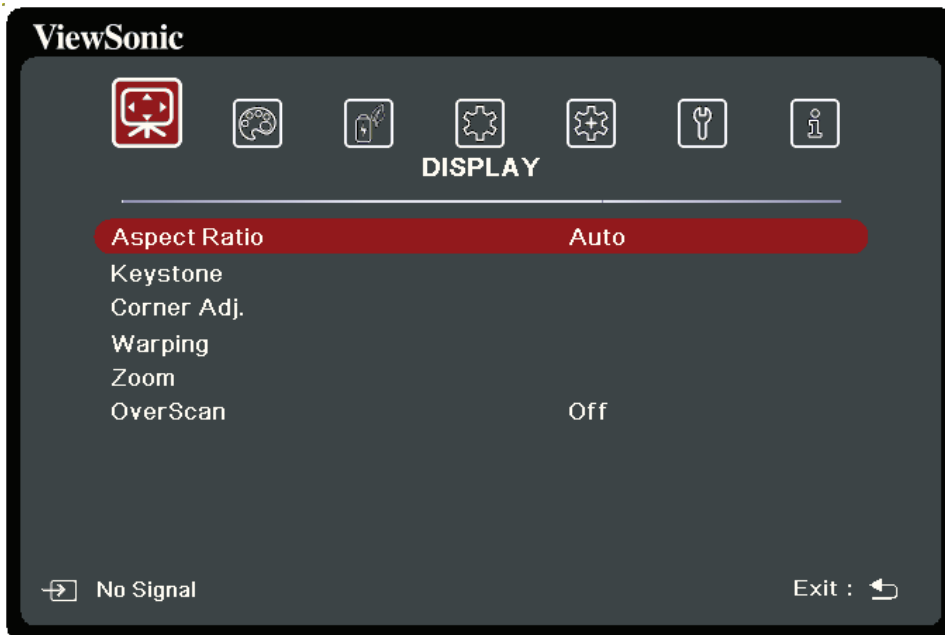

Main Menu	Sub-menu	Menu Option		
<b>SYSTEM</b>	Language	Multi-Language OSD Selection		
	Projector Position	Front Table		
		Rear Table		
		Rear Ceiling		
		Front Ceiling		
	Menu Settings	Menu Display Time	5 sec/10 sec/15 sec/20 sec/25 sec/30 sec	
		Menu Position	Center/Top-Left/Top-Right/Bottom-Left/Bottom-Right	
	High Altitude Mode	Off		
		On		
	Quick Auto Search	Off		
		On		
	Security Settings	Change Password		
		Power On Lock		Off/On
	Panel Key Lock	Off		
		On		
Control Method	RS232			
	Service			
Baud Rate	2400/4800/9600/14400/19200/38400/57600/115200			
<b>INFORMATION</b>	Source			
	Color Mode			
	Resolution			
	Color System			
	Firmware Version			
	Ultra Fast Input			
	S/N			

## DISPLAY Menu

1. Press the **MENU** or  button to display the On-Screen Display (OSD) Menu.
2. Press / to select the **DISPLAY** menu. Then press **ENTER/OK** or use / to access the **DISPLAY** menu.







3. Press / to select the menu option. Then press **ENTER/OK** to display its sub-menu, or press / to adjust/select the setting.

**NOTE:** Some sub-menu options may have another sub-menu. To enter the respective sub-menu, press **ENTER/OK**. Use / or / to adjust/select the setting.





Menu Option	Description
Aspect Ratio	<p><u>Auto</u> Scales an image proportionally to fit the projector's native resolution in its horizontal width. This is suitable for the incoming image which is neither in 4:3 nor 16:9 and you want to make most use of the screen without altering the image's aspect ratio.</p> <p><u>4:3</u> Scales an image so that it is displayed in the center of the screen with a 4:3 aspect ratio. This is most suitable for 4:3 images like computer monitors, standard definition TV, and 4:3 aspect DVD movies, as it displays them without aspect alteration.</p> <p><u>16:9</u> Scales an image so that it is displayed in the center of the screen with a 16:9 aspect ratio. This is most suitable for images which are already in a 16:9 aspect, like high definition TV, as it displays them without aspect alteration.</p> <p><u>16:10</u> Scales an image so that it is displayed in the center of the screen with a 16:10 aspect ratio. This is most suitable for images which are already in a 16:10 aspect, as it displays them without aspect alteration.</p> <p><u>2.35:1</u> Scales an image so that it is displayed in the center of the screen with a 2.35:1 aspect ratio without aspect alteration.</p> <p><u>Native</u> Projects an image as its original resolution and resizes it to fit within the display area. For input signals with lower resolutions, the projected image will be displayed in its original size.</p>
Keystone	Adjusts the keystone situation where the projected image becomes a trapezoid due to angled projection.
Corner Adj.	Adjusts the shape and size of an image that is unevenly rectangular on all sides.



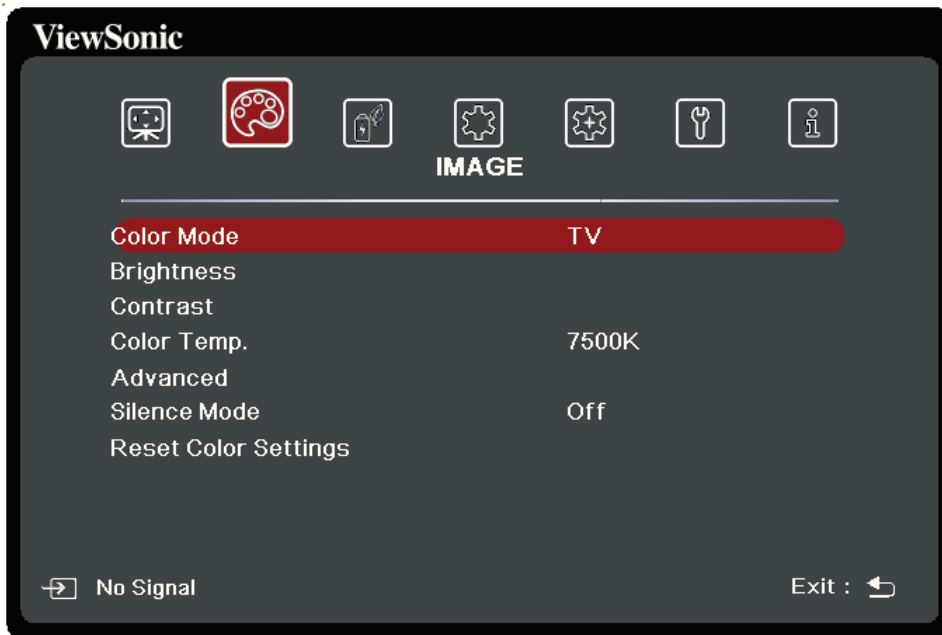

Menu Option	Description
Warping	<p>The function is to configure the geometric distortion of the projector's images when the images are projected onto screens which have a kind of uneven surface such as a cylinder, a spherical shape, etc.</p> <p><u>Enable</u> Keystone and Corner Adj. will not be available when Warping is enabled.</p> <p><u>Control Method</u> Allows you to select a preferred control method for warping adjustment.</p> <p><u>Warping Adj.</u> This function is available when On is selected in the Warping &gt; Enable menu and OSD is selected in the Warping &gt; Control Method menu.</p> <ol style="list-style-type: none"> <li>1. Use ▲/▼/◀/▶ to move the cursor to the point you wish to adjust.</li> <li>2. Press <b>Enter</b> to enter adjustment mode.</li> <li>3. Use ▲/▼/◀/▶ to shift the point by x and y coordinates.</li> <li>4. Press <b>MENU</b> to exit adjustment mode.</li> <li>5. Repeat step 1 to 4 to adjust another point until you are satisfied with the projected image.</li> <li>6. Press <b>MENU/Exit</b> to exit the function.</li> </ol> <p><u>Reset</u> Returns settings in the Warping menu to the factory preset values.</p>
Zoom	Magnifies the projected image and allows you to navigate the image.
OverScan	Adjusts the overscan rate from 0 to 5.







## IMAGE Menu

1. Press the **MENU** or  button to display the On-Screen Display (OSD) Menu.
2. Press / to select the **IMAGE** menu. Then press **ENTER/OK** or use / to access the **IMAGE** menu.







3. Press / to select the menu option. Then press **ENTER/OK** to display its sub-menu, or press / to adjust/select the setting.

**NOTE:** Some sub-menu options may have another sub-menu. To enter the respective sub-menu, press **ENTER/OK**. Use / or / to adjust/select the setting.





Menu Option	Description
Color Mode	<p><u>Brightest</u> Maximizes the brightness of the projected image. This mode is suitable for environments where extra-high brightness is required, such as using the projector in well lit rooms.</p> <p><u>TV</u> Optimized for viewing sports in well-lit environments.</p> <p><u>Gaming</u> Suitable for playing video games in a bright living room.</p> <p><u>Movie</u> For playing colorful movies, video clips from digital cameras or DVs through the PC input for best viewing in a blackened (little light) environment.</p> <p><u>User</u> Recalls the customized settings. After User/Low Blue Light is selected, some of the sub-menus under the <b>IMAGE</b> menu can be adjusted, according to your selected input source.</p> <p><u>Low Blue Light</u> Reduces the emission of harmful low-blue light that is harmful to human’s eyesight.</p>
Brightness	<p>The higher the value, the brighter the image. Adjust this option so the black areas of the image appear just as black and details in the dark area are more visible.</p> <div style="display: flex; justify-content: space-around; align-items: flex-end;">    </div>
Contrast	<p>Use this to set the peak white level after you have previously adjusted the <b>Brightness</b> setting.</p> <div style="display: flex; justify-content: space-around; align-items: flex-end;">    </div>
Color Temp.	<p>There are several preset color temperature settings (<u>9300K</u>, <u>7500K</u>, <u>6500K</u>) available. The available settings may vary according to the personal preferences.</p> <p>To set a custom color temperature, you can further adjust the following items:</p> <p><u>Red Gain/Green Gain/Blue Gain</u> Adjusts the Contrast levels of Red, Green, and Blue.</p> <p><u>Red Offset/Green Offset/Blue Offset</u> Adjusts the Brightness levels of Red, Green, and Blue.</p>

Menu Option	Description
Advanced	<p><u>Color</u> A lower setting produces less saturated colors. If the setting is too high, colors will be overpowering and may appear unrealistic.</p> <p><u>Sharpness</u> A higher value will sharpen the image, while a lower value will soften the image.</p> <p><u>Gamma</u> Gamma refers to the brightness level of the projector's grayscale levels.</p> <p><u>Color Management</u> Only in permanent installations with controlled lighting levels such as boardrooms, lecture theaters, or home theaters, should color management be considered. Color management provides fine color control adjustment to allow for more accurate color reproduction. Select Primary Color first and adjust its range/values in Hue, Saturation and Gain.</p>
Silence Mode	<p>Minimizes the acoustic noise. It is suitable for the need of watching movies that requires an ultra-quiet environment so that you won't be disturbed by the noise of the projector. When this mode is selected, XPR will be off (the projected image will be switched to 1080p resolution automatically).</p>
Reset Color Settings	<p>Returns current image settings to the factory preset values.</p>

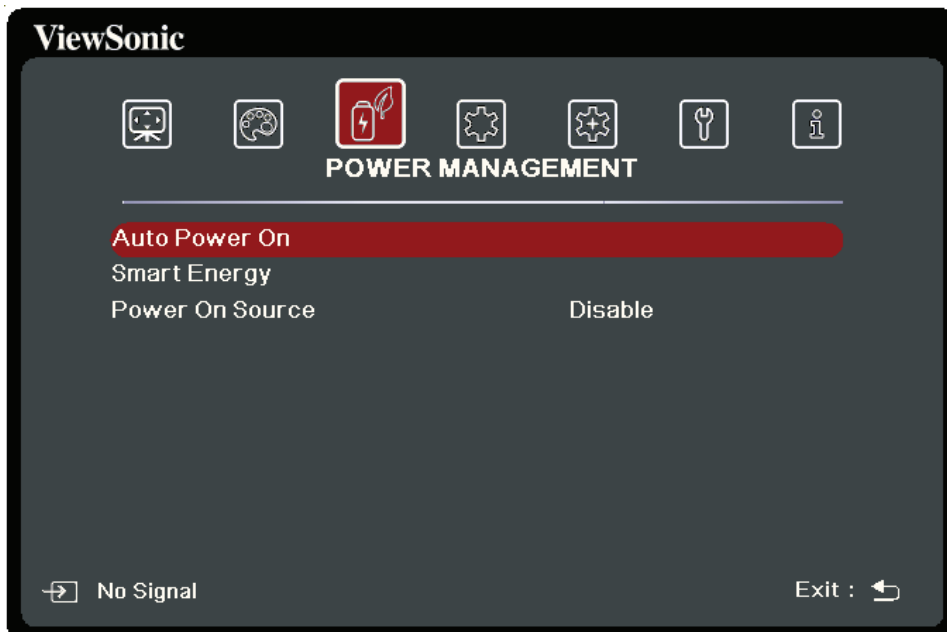
# POWER MANAGEMENT Menu

1. Press the **MENU** or  button to display the On-Screen Display (OSD) Menu.
2. Press / to select the **POWER MANAGEMENT** menu. Then press **ENTER/OK** or use / to access the **POWER MANAGEMENT** menu.







3. Press / to select the menu option. Then press **ENTER/OK** to display its sub-menu, or press / to adjust/select the setting.

**NOTE:** Some sub-menu options may have another sub-menu. To enter the respective sub-menu, press **ENTER/OK**. Use / or / to adjust/select the setting.







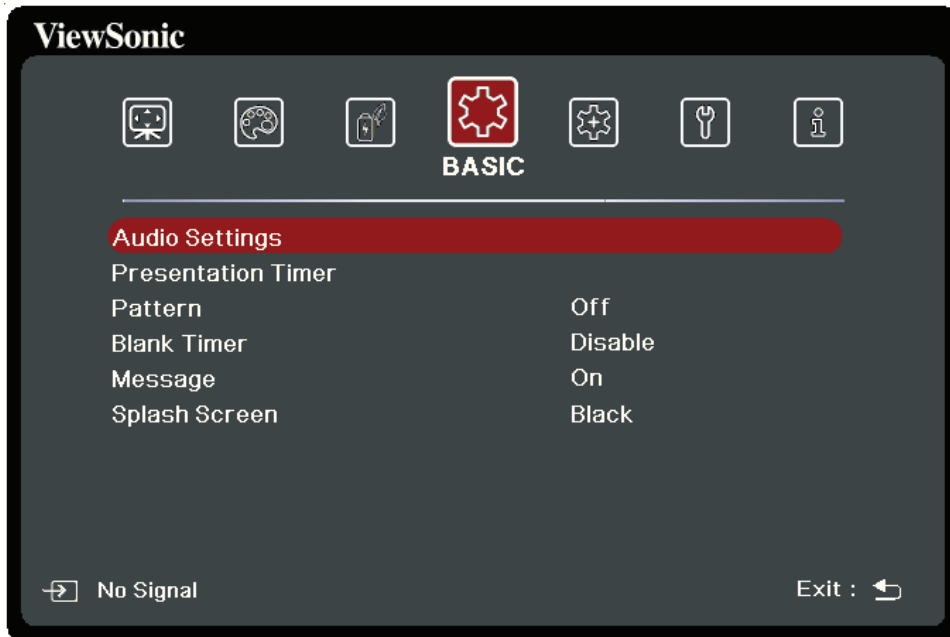

Menu Option	Description
Auto Power On	<p><u>Signal</u> Selecting HDMI allows the projector to turn on automatically once the HDMI/USB C signal is fed through the HDMI/USB C cable.</p> <p><u>CEC</u> This projector supports CEC (Consumer Electronics Control) function for synchronized power on/off operation via HDMI connection. That is, if a device that also supports CEC function is connected to the HDMI input of the projector, when the projector's power is turned off, the power of the connected device will also be turned off automatically. When the power of the connected device is turned on, the projector's power will be turned on automatically.</p> <p><b>NOTE:</b></p> <ul style="list-style-type: none"> <li>• In order for the CEC function to work properly, make sure that the device is correctly connected to the HDMI input of the projector via an HDMI cable, and its CEC function is turned on.</li> <li>• Depending on the connected device, the CEC function may not work.</li> </ul> <p><u>Direct Power On</u> Allows the projector to turn on automatically once power is fed through the power cord.</p>
Smart Energy	<p><u>Auto Power Off</u> Allows the projector to turn off automatically after a set period of time once no input source is detected to prevent unnecessary waste of light source life.</p> <p><u>Sleep Timer</u> Allows the projector to turn off automatically after a set period of time to prevent unnecessary waste of light source life.</p> <p><u>Power Saving</u> Lowers power consumption if no input source is detected. When Enable is selected, the projector light source mode will change to SuperEco mode after no signal is detected for five (5) minutes. This will also help prevent any unnecessary waste of light source life.</p>
Power On Source	Enters the desired input source directly after turning on the projector.

## BASIC Menu

1. Press the **MENU** or  button to display the On-Screen Display (OSD) Menu.
2. Press / to select the **BASIC** menu. Then press **ENTER/OK** or use / to access the **BASIC** menu.







3. Press / to select the menu option. Then press **ENTER/OK** to display its sub-menu, or press / to adjust/select the setting.

**NOTE:** Some sub-menu options may have another sub-menu. To enter the respective sub-menu, press **ENTER/OK**. Use / or / to adjust/select the setting.





Menu Option	Description
Audio Settings	<p><u>Audio Mode</u> Select a preferred audio mode to suit your audio content.</p> <p><u>Mute</u> Select On to temporarily turn off the projector’s internal speaker or the volume being output from the audio output jack.</p> <p><u>Audio Volume</u> Adjusts the volume level of the projector’s internal speaker or the volume being output from the audio output jack.</p> <p><u>Power On/Off Ring Tone</u> Turns on/off the ring tone during the starting up and shutting down process.</p>
Presentation Timer	<p>Presentation timer can indicate the presentation time on the screen to help you achieve better time management when giving presentations.</p> <p><u>Timer Period</u> Sets the time period. If the timer is already on, the timer will restart whenever the Timer Period is reset.</p> <p><u>Timer Display</u> Allows you to decide if you want the timer to show up on the screen for one of the following time periods:</p> <ul style="list-style-type: none"> <li>» Always: Displays the timer on screen throughout the presentation time.</li> <li>» 1 min/2 min/3 min: Displays the timer on screen in the last 1/2/3 minute(s).</li> <li>» Never: Hides the timer throughout the presentation time.</li> </ul> <p><u>Timer Position</u> Sets the timer position.</p> <p><u>Timer Counting Direction</u> Sets your desired counting direction between:</p> <ul style="list-style-type: none"> <li>» Count Down: Decreases from the preset time to 0.</li> <li>» Count Up: Increases from 0 to the preset time.</li> </ul> <p><u>Sound Reminder</u> Allows you to decide if you want to activate a sound reminder. Once enabled, a double beep sound will be heard at the last 30 seconds of counting down/up, and a triple beep sound will be produced when the timer is up.</p> <p><u>Start Counting/Off</u> Select Start Counting to activate the timer. Select Off to cancel it.</p>



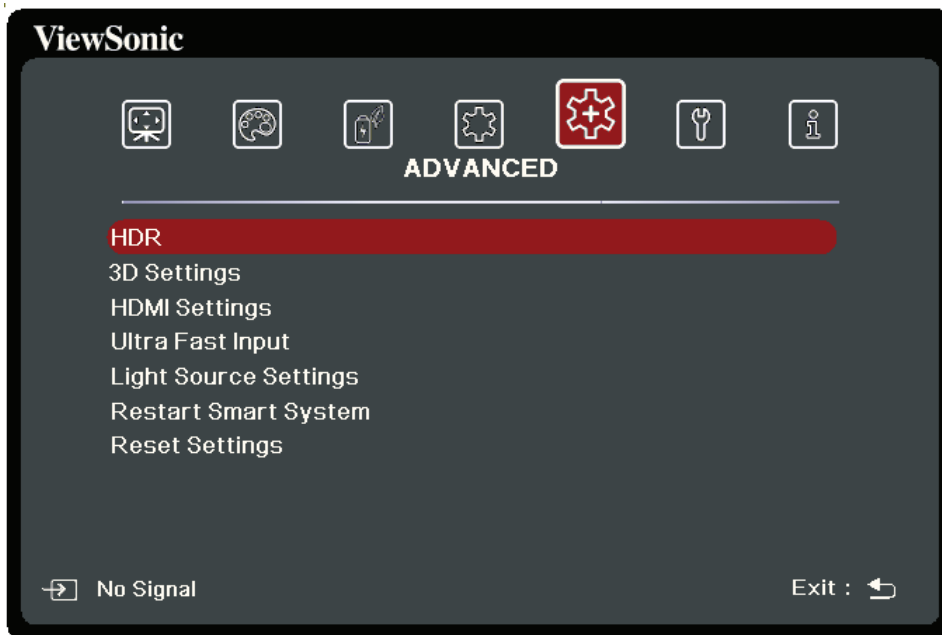

<b>Menu Option</b>	<b>Description</b>
Pattern	Helps adjust the image size and focus, and checks for distortion in the projected image.
Message	Sets reminder messages On or Off.
Splash Screen	Selects which logo screen will appear during projector start-up.

## ADVANCED Menu

1. Press the **MENU** or  button to display the On-Screen Display (OSD) Menu.
2. Press / to select the **ADVANCED** menu. Then press **ENTER/OK** or use / to access the **ADVANCED** menu.



3. Press / to select the menu option. Then press **ENTER/OK** to display its sub-menu, or press / to adjust/select the setting.

**NOTE:** Some sub-menu options may have another sub-menu. To enter the respective sub-menu, press **ENTER/OK**. Use / or / to adjust/select the setting.





Menu Option	Description
HDR	<p><u>HDR/HLG</u> The projector supports HDR imaging sources. It can automatically detect the dynamic range of the source, and optimize image gamma and color settings to reproduce contents under wide range of light conditions. You also select SDR.</p> <p><u>EOTF</u> The projector can automatically adjust the brightness levels of your image according to the input source. Normally, the default setting “Mid” is recommended. If the brightness of the projected image is dark, please use “Low”. When giving priority to gradation property, please use “High”.</p>
3D Settings	<p>This projector features a 3D function which enables you to enjoy 3D movies, videos, and sporting events in a more realistic way by presenting the depth of the images. You need to wear a pair of 3D glasses to view 3D images.</p> <p><u>3D Format</u> The default setting is Auto and the projector automatically chooses an appropriate 3D format when detecting 3D contents. If the projector cannot recognize the 3D format, choose a 3D mode.</p> <p><u>3D Sync Invert</u> When you discover the inversion of the image depth, enable this function to correct the problem.</p> <p><u>Save 3D Settings</u> Saves current 3D settings. 3D settings will automatically be applied if the same resolution and input source are selected.</p> <p><b>NOTE:</b> When the 3D Sync function is on:</p> <ul style="list-style-type: none"> <li>• The brightness level of the projected image will decrease.</li> <li>• The Color Mode, Light Source Mode, Zoom, and OverScan cannot be adjusted.</li> </ul>

Menu Option	Description
HDMI Settings	<p><u>HDMI Format</u>            Select a suitable color space according to the color space setting of the output device connected.</p> <ul style="list-style-type: none"> <li>» Auto: Sets the projector to detect the color space setting of the input signal automatically.</li> <li>» RGB: Sets the color space as RGB.</li> <li>» YUV: Sets the color space as YUV.</li> </ul> <p><u>HDMI Range</u>            Select a suitable HDMI color range according to the color range setting of the output device connected.</p> <ul style="list-style-type: none"> <li>» Auto: Sets the projector to detect the HDMI range of the input signal automatically.</li> <li>» Enhanced: Sets the HDMI color range as 0 - 255.</li> <li>» Normal: Sets the HDMI color range as 16 - 235.</li> </ul>
Ultra Fast Input	<p>This function is favorable to frame rate reducing. Quick response time in native timing can be achieved. When enabled, the following settings (if applicable) will return to factory preset values: Aspect Ratio, Zoom, OverScan.</p> <p><b>NOTE:</b> This function is only available when a 4K@60Hz, 1440P@60/120Hz and 1080P@60/120/240Hz input signal is selected.</p>





Menu Option	Description
Light Source Settings	<p><u>Light Source Mode</u></p> <ul style="list-style-type: none"> <li>» Normal: Provides full light source brightness.</li> <li>» Eco: Reduces light source power consumption by 40% and lowers brightness to extend the light source life and decreases the fan noise.</li> <li>» Dynamic Black 1: Reduces light source power consumption by up to 70% depending on the content brightness level.</li> <li>» Dynamic Black 2: Reduces light source power consumption by up to 50% depending on the content brightness level.</li> <li>» Custom: Allows you to adjust the light source power.</li> </ul> <p><u>Light Source Power</u> Only available when Light Source Mode is Custom.</p> <p><u>Reset Light Source Hours</u> Resets the light source timer after a new light source is installed. For changing the light source, please contact qualified service personnel.</p> <p><u>Light Source Hours Information</u></p> <ul style="list-style-type: none"> <li>» Light Source Usage Time: Displays the number of hours the light source has been used.</li> </ul>
Restart Smart System	Restarts the Smart System immediately after selecting Reset.
Reset Settings	Returns all settings to the factory preset values. When using Reset Settings, the following settings will still remain: Zoom, Keystone, Language, Projector Position, High Altitude Mode, Security Settings, Control Method, Baud Rate and SMART SYSTEM.

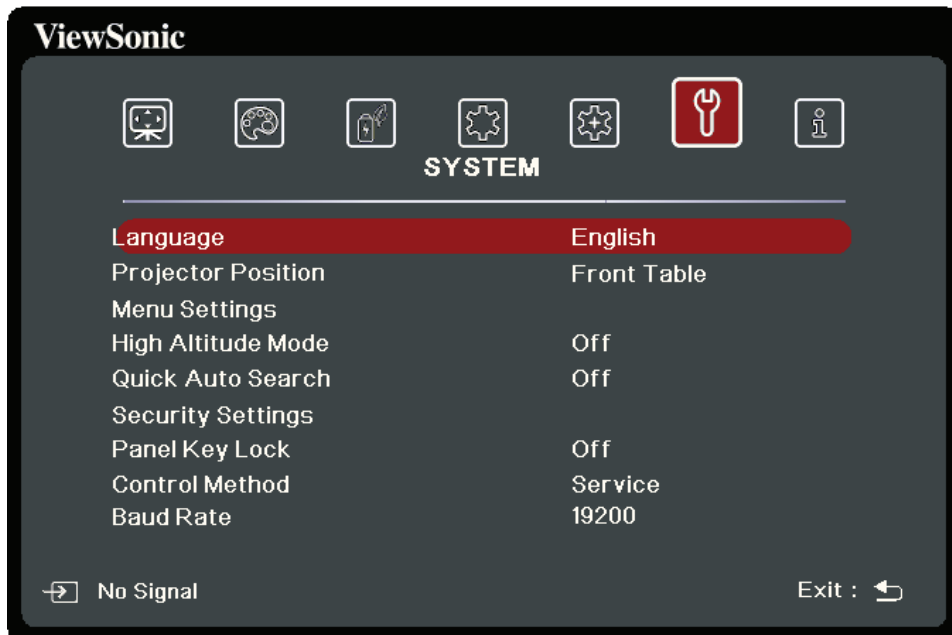

## SYSTEM Menu

1. Press the **MENU** or  button to display the On-Screen Display (OSD) Menu.
2. Press / to select the **SYSTEM** menu. Then press **ENTER/OK** or use / to access the **SYSTEM** menu.





3. Press / to select the menu option. Then press **ENTER/OK** to display its sub-menu, or press / to adjust/select the setting.

**NOTE:** Some sub-menu options may have another sub-menu. To enter the respective sub-menu, press **ENTER/OK**. Use / or / to adjust/select the setting.

Menu Option	Description
Language	Sets the language for the On-Screen Display (OSD) Menu.
Projector Position	Selects a proper position for the projector.
Menu Settings	<p><u>Menu Display Time</u> Sets the length of time the OSD Menu will remain active after your last interaction.</p> <p><u>Menu Position</u> Sets the OSD Menu's position.</p>
High Altitude Mode	<p>We recommend you use the High Altitude Mode when your environment is between 1,500 m to 3,000 m above sea level, and ambient temperature is between 0°C–30°C.</p> <p><b>NOTE:</b></p> <ul style="list-style-type: none"> <li>• Do not use High Altitude Mode if your environment is between 0 to 1,499 m, and the temperature is between 0°C to 35°C. If used, the projector will become over cooled.</li> <li>• Using “High Altitude Mode” may cause more operating noise, as the fan speed will be increased to improve cooling and performance.</li> </ul>
Quick Auto Search	Allows the projector to automatically search for the signals.
Security Settings	See “Using the Password Function” on page 21.
Panel Key Lock	Locks the control keys on the projector.
Control Method	Allows you to select a preferred control port: through the RS232 port or the USB port (Service).
Baud Rate	Selects a baud rate that is identical with your computer's so that you can connect the projector using a suitable RS-232 cable and control the projector with RS-232 commands

# INFORMATION Menu

1. Press the **MENU** or  button to display the On-Screen Display (OSD) Menu.
2. Press  /  to select the **INFORMATION** menu and display its contents.

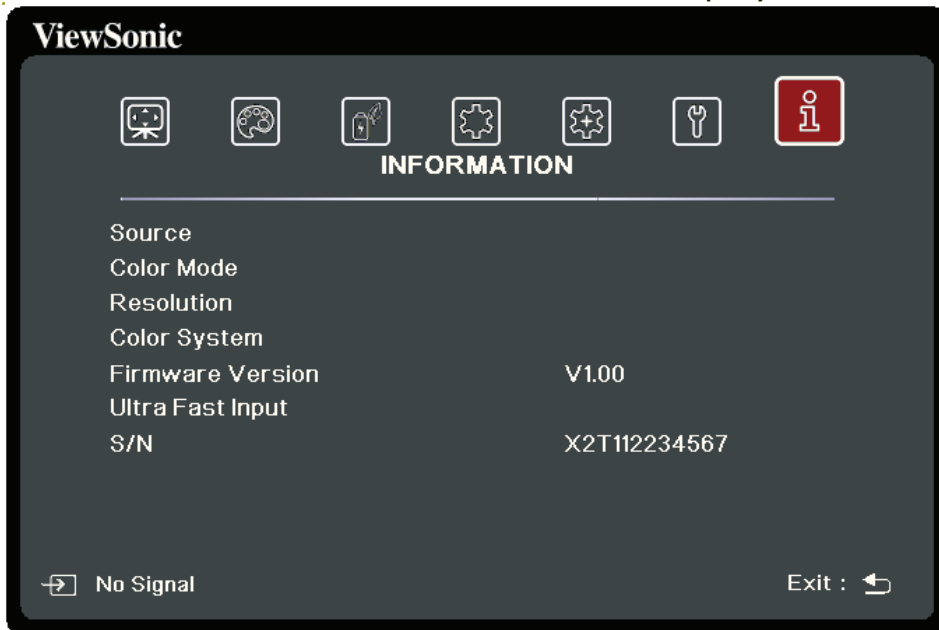

Menu Option	Description
Source	Shows the current input source.
Color Mode	Shows the selected mode in the IMAGE menu.
Resolution	Shows the native resolution of the input source.
Color System	Shows input system format.
Firmware Version	Shows the current firmware version.
Ultra Fast Input	Shows whether the function is activated or not.
S/N	Shows the serial number for this projector.

# Smart System

This section will introduce the **SMART SYSTEM**.

## Home Screen

The **Home Screen** is displayed every time you start the projector. To navigate the **Home Screen**, simply use the directional buttons on the remote control. You can return to the main **Home Screen** at any time by pressing the **Home** button on the remote control, regardless of what page you are on.

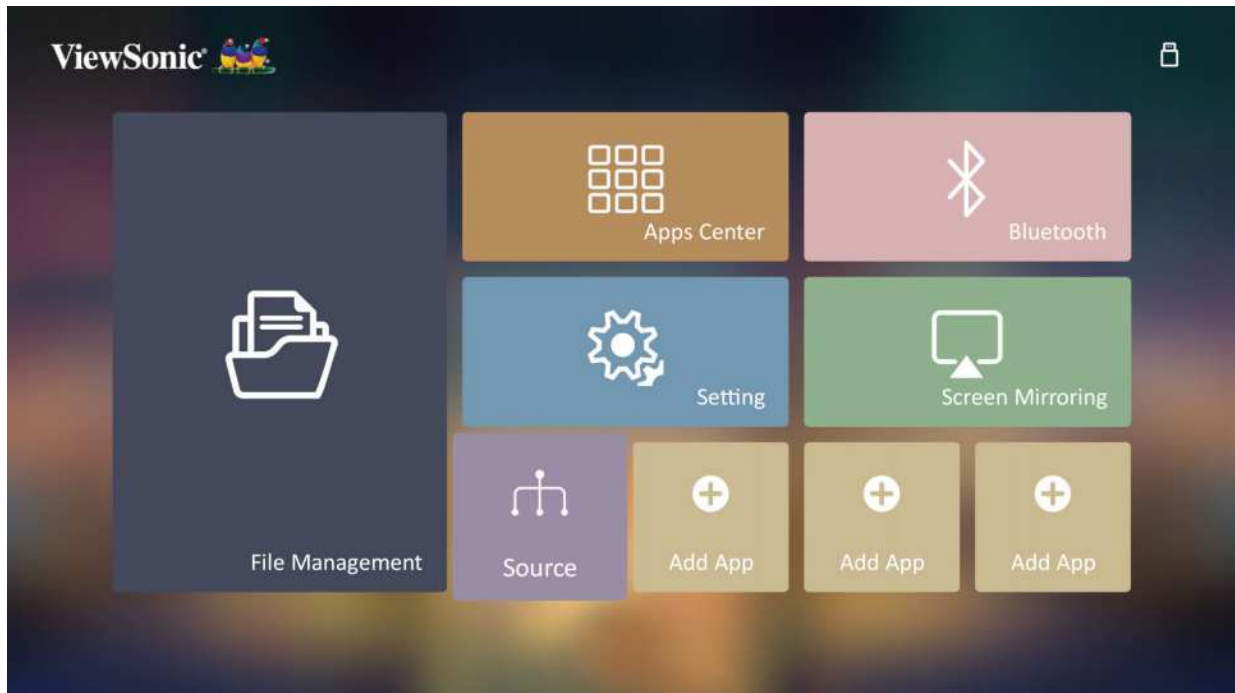

Menu	Description
File Management	Provides a user interface to manage files and folders.
Apps Center	Access and view all the applications you have installed.
Bluetooth	Select the appropriate Bluetooth mode.
Setting	Manage various categories such as: Network settings, Basic and Advanced settings, Date & Time, Firmware update, and System Information.
Screen Mirroring	Mirror your personal device's screen through the projector.
Add App	Select your favorite Apps and add them to the <b>Home Screen</b> .

# Home Screen - On-Screen Display (OSD) Menu Tree

Main Menu	Sub-menu	Menu Option			
File Management					
Apps Center					
Bluetooth					
Settings	Network Settings	Wi-Fi	Disable		
			Enable	SSID:	
				Configure IP	
				IP Address	
				Subnet Mask	
				Default Gateway	
DNS Server					
Settings	Basic Settings	Language	Multi-Language OSD Selection		
	Date & Time	Automatic Date & Time	Disable		
			Enable		
		Date			
		Time			
		Time Zone			
	Time Format	12 hours			
		24 hours			
	Firmware Upgrade	Software Update Online			
					Software Update by USB
		OTA Reminder	Disable		
Enable					
Software Version					

Main Menu	Sub-menu	Menu Option	
	Advanced Settings	Reset Settings	OK
			Cancel
		Reset To Factory Default	OK
			Cancel
	Information	System Version	
		Memory Information	
Wi-Fi Mac Address			
<b>Screen Mirroring</b>			
<b>Add App</b>			
<b>Add App</b>			
<b>Add App</b>			
<b>Add App</b>			

# Menu Operations

## File Management

Easily manage files and folders.

1. Select: **Home > File Management.**

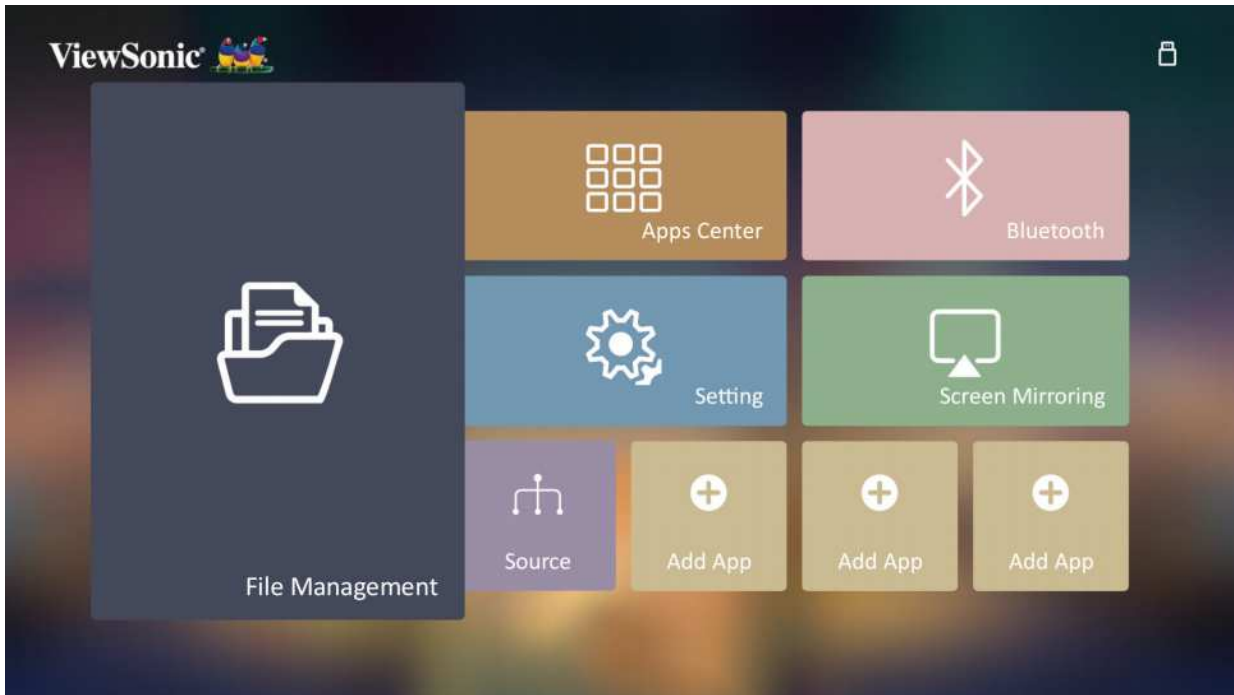

2. Select a device on the source list: USB, Local Storage, etc. Use the direction buttons to select the desired file. Then press **OK** on the remote control to open the selected file.



3. Press the **Return** button to go to a previous a level.

**NOTE:** Press the **Home** button on the remote control to return to the **Home Screen** at anytime.

## How to Edit a File

1. While in **File Management**, press and hold the **OK** button for three (3) seconds.
2. A check box will appear at the front of each file. Use the direction buttons and press **OK** to select one or more files.

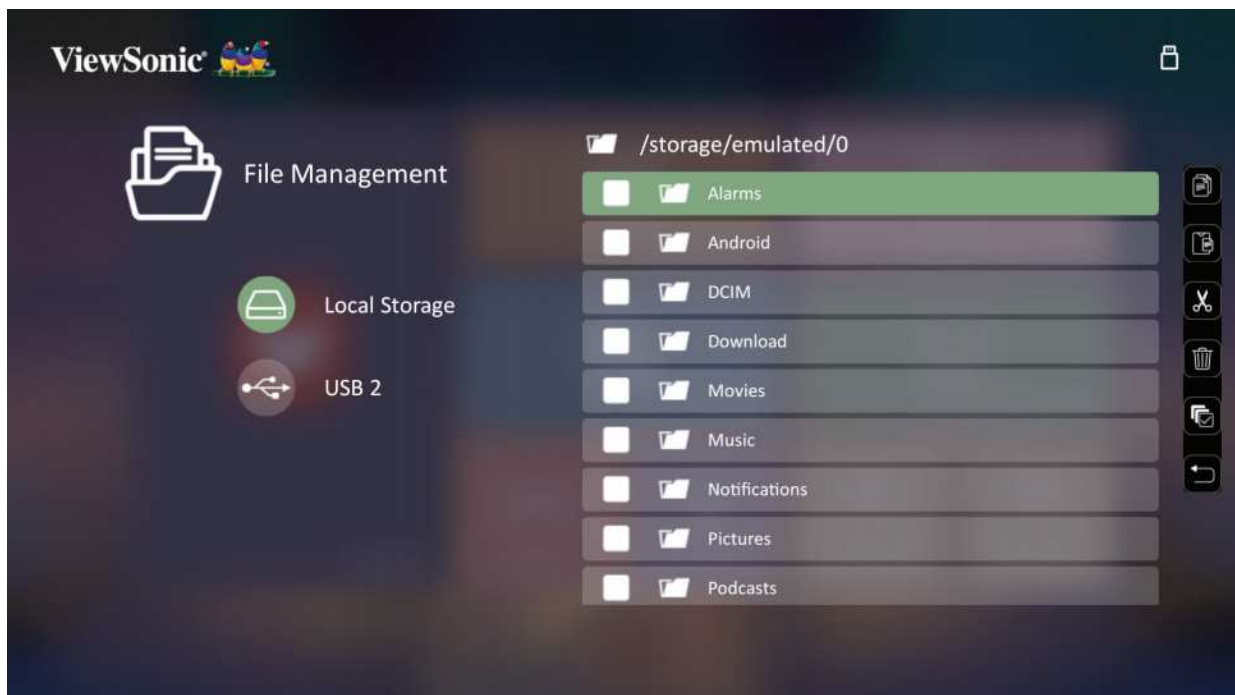

3. By pressing the **Right** button, Copy, Paste, Cut, Delete, Select All, and Return boxes will be displayed.

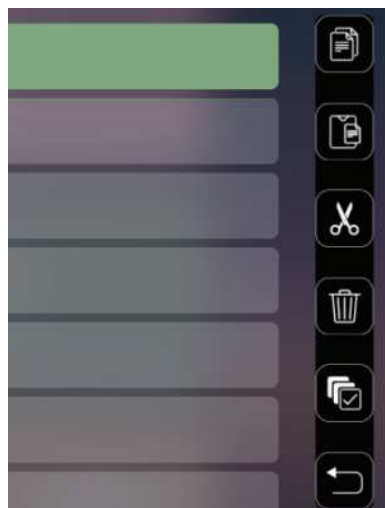























4. Select your desired action and press **OK** to execute.
5. If you are Copying or Cutting, select your destination folder to complete the process.



## How to Use Control Bar Buttons

The Control Bar buttons will appear on screen if a video, music, or photo file are selected to be opened.

Picture		Video		Music	
	Back		Back		Back
	Play		Rewind		Play
	Next		Play		Pause
	Zoom in		Pause		Next
	Zoom out		Fast Forward		Shuffle
	Rotate (left)		Next		Repeat All
	Rotate (right)				Repeat One
					Play List
					Information

## Tips for Using USB

When using USB for reading and/or storage please keep in mind the following:

1. Some USB storage devices may not be compatible.
2. If you use an USB extension cable, the USB device may not recognize the USB.
3. Only use USB storage devices formatted with Windows FAT32 or NTFS file system.
4. Larger files will need extra time to load.
5. Data on USB storage devices may be damaged or lost. Back up important files.

## Supported File Formats

Supported Office formats:

	Item	Indicators
<b>Document viewing function</b>	doc/docx	Able to open and read documents in doc/docx
	xls/xlsx	Able to open and read documents in xls/xlsx
	ppt/pptx	Able to open and read documents in ppt/pptx
	Pdf	Able to open and read documents in pdf
<b>Supporting Interface Language</b>	Supporting Interface 44 languages	English, Simplified Chinese, Chinese (TW), Chinese (HK), Spanish (LA), French (EU), PT (EU), PT (BR), German, Russian, Italian, Swedish, Spanish (EU), Korean, Arabic, Farsi, Serbian, Bosnian, Macedonian, Bulgarian, Ukrainian, Greek, Norwegian, Danish, Czech, Hungarian, Slovak, Polish, Romanian, Finnish, Estonian, Latvian, Lithuanian, British English, Slovenian, Croatian, Turkish, Vietnamese, Bahasa Indonesia, Dutch, Malay, Thai, Hindi, Hebrew, Burmese, Catalan.

Supported Multimedia formats:

Extension	Codec	
.avi	Video	H.264, H.265
	Audio	MP3
.mp4* .mov	Video	H.264, H.265/MPEG 4
.mkv	Video	H.264, H.265
.ts	Video	H.264, H.265, MPEG2
	Audio	MP3
.vob	Video	MPEG1, MPEG2
	Audio	DVD-LPCM
.mpg	Video	MPEG1

**NOTE:** Video Resolution 3840 x 2160 with Video decode format AVC (CABAC / 3 Ref Frames ) is not supported by MP4

Supported Photo formats:

Format	Type	Maximum Resolution
.jpg/.jpeg	Progressive JPEG	7680 x 4320
	Baseline JPEG	7680 x 4320
.bmp		9600 x 6400
.png		7680 x 4320

Supported External Connected Device formats:

Device	Support Size (Max. Size)	NTFS Format		FAT32 Format		exFAT	
		Read	Write	Read	Write	Read	Write
USB Memory Stick	256 GB	V	N/A	V	V	N/A	N/A
USB HDD	2 TB	V	N/A	V	V	N/A	N/A

**NOTE:**

- Windows 10 built-in format tool only supports FAT32 format up to 32 GB.
- Firmware upgrade only supports FAT32 format.

## Apps Center

View, launch, and uninstall Apps.

1. To view your Apps, select: **Home > Apps Center**.

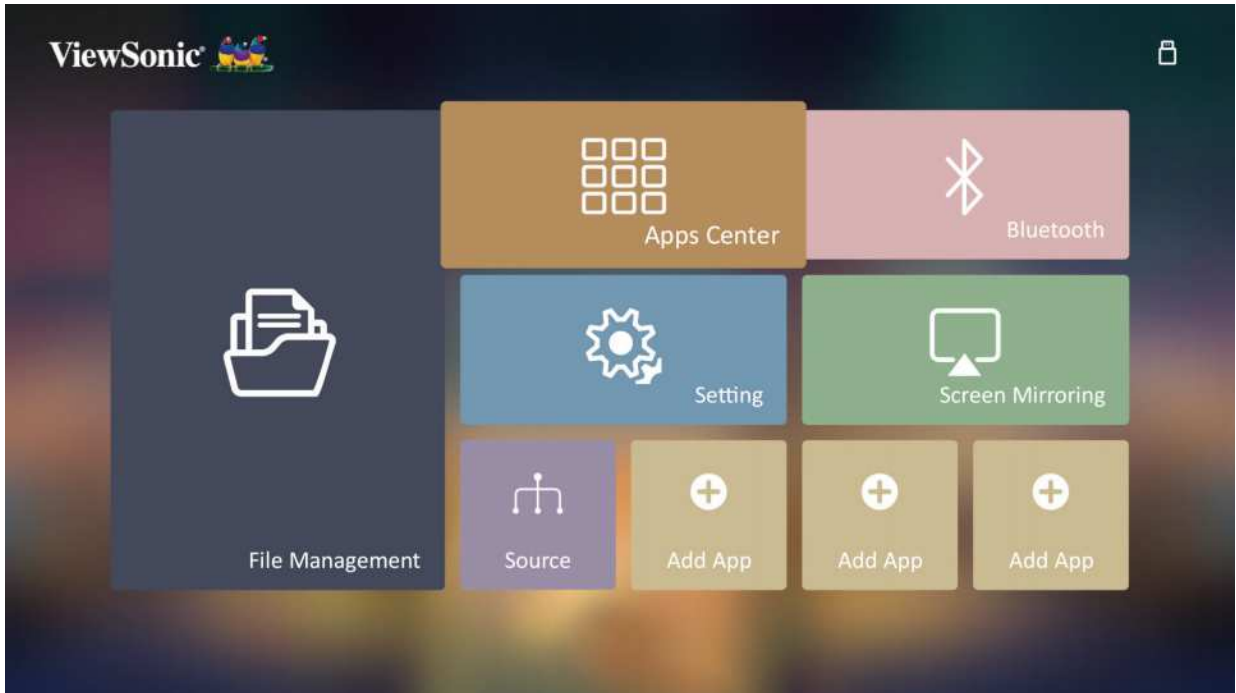

2. Use the direction buttons to select the desired App. Then press **OK** on the remote control to launch the App.

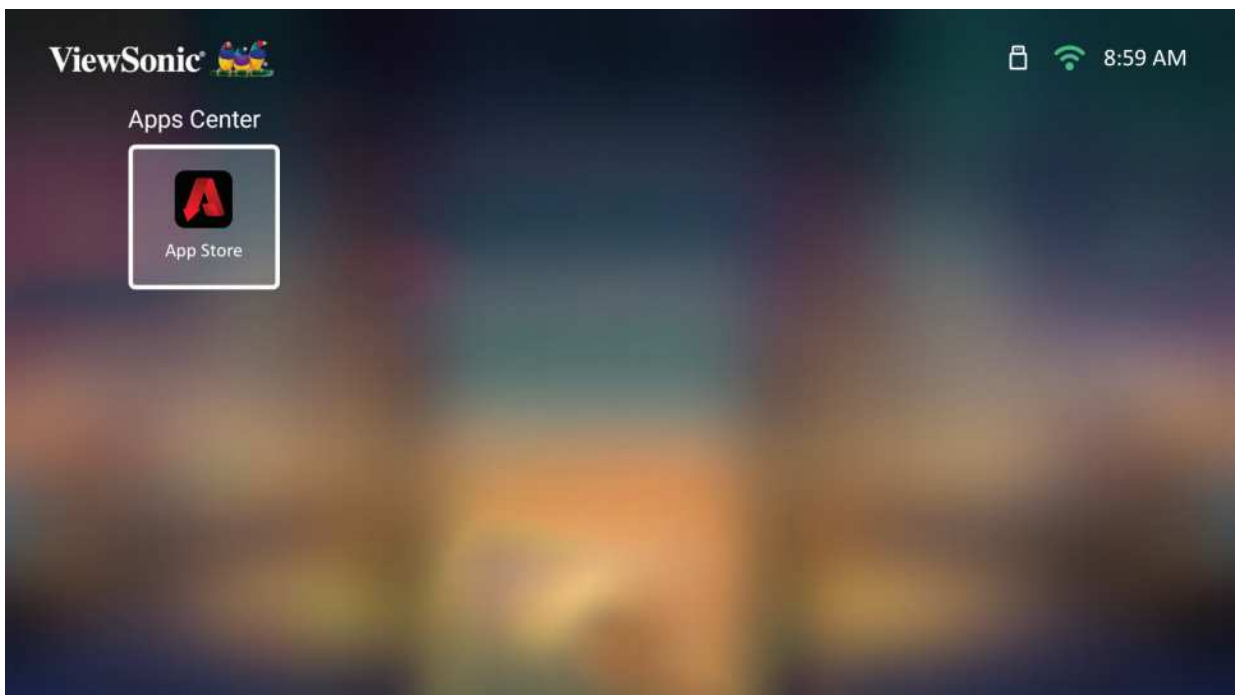

**NOTE:** Press the **Home** button on the remote control to return to the **Home Screen** at anytime.

## ViewSonic App Store

Use the direction buttons to navigate the menu options. When you find the preferred App, press the **OK** button on the remote control to install the App.

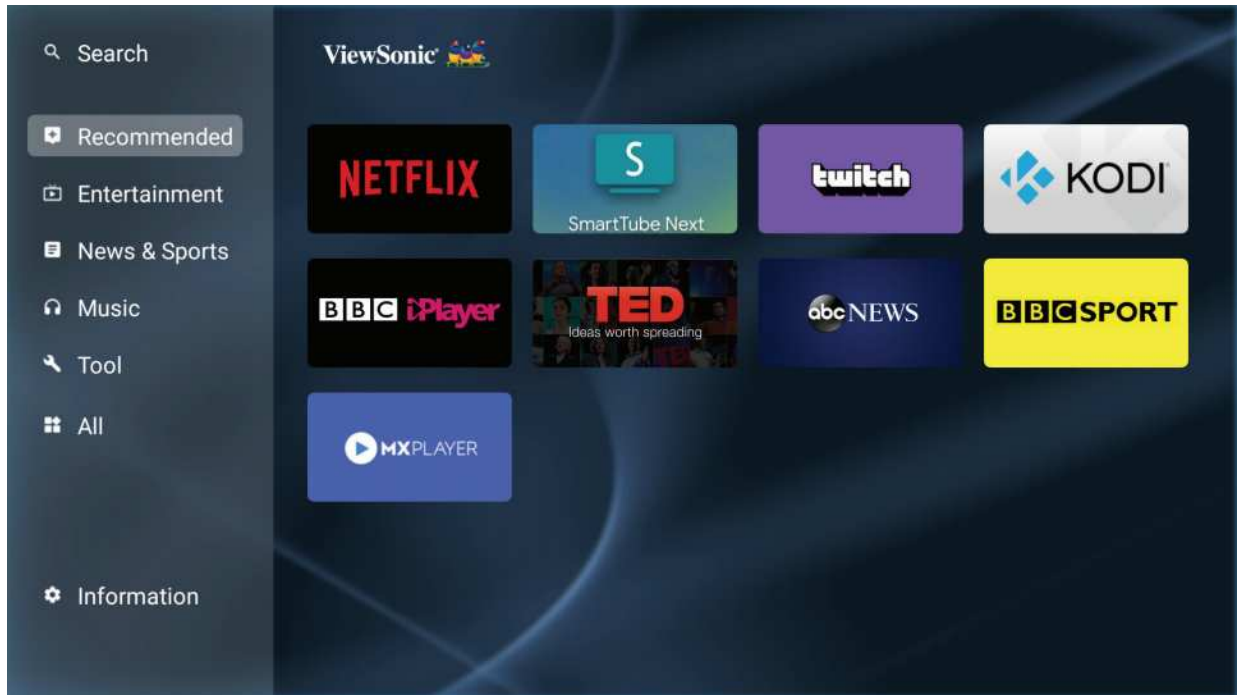

### NOTE:

- Users can install third-party Apps by .apk file in **File Management**. However, some third-party Apps may have compatibility issues.
- Apps not pre-loaded by ViewSonic may not be compatible or work properly.
- Some Apps may require a Keyboard and Mouse.
- Some Apps may be Region-Specific.

## To Uninstall Apps

1. Open the **Apps Center** by selecting: **Home > Apps Center**.
2. Use the directional buttons to select the desired App.
3. Press and hold **OK** on the remote control for three (3) seconds. The below dialogue box will appear:

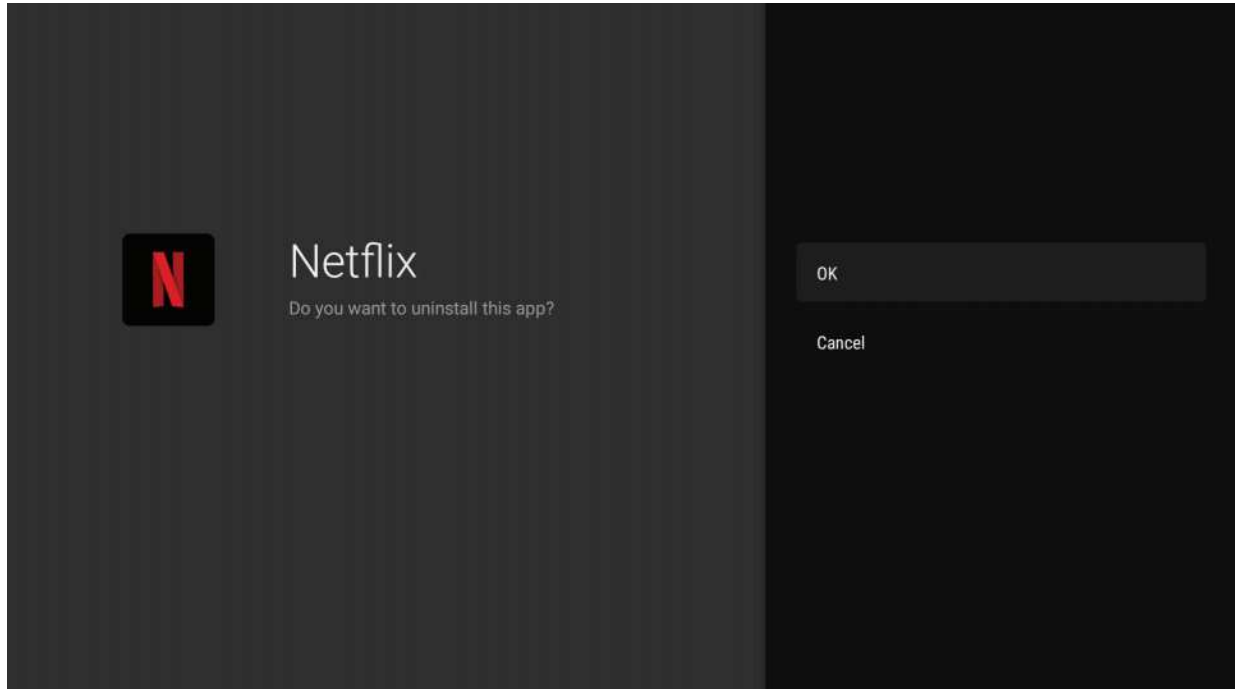

4. Select **OK** to uninstall the App.

**NOTE:** Press the **Home** button on the remote control to return to the **Home Screen** at anytime.

## Bluetooth

The projector is equipped with Bluetooth that allows the user to connect their device wirelessly for audio playback.

**NOTE:** Pair your device with the projector before using the Bluetooth speaker.

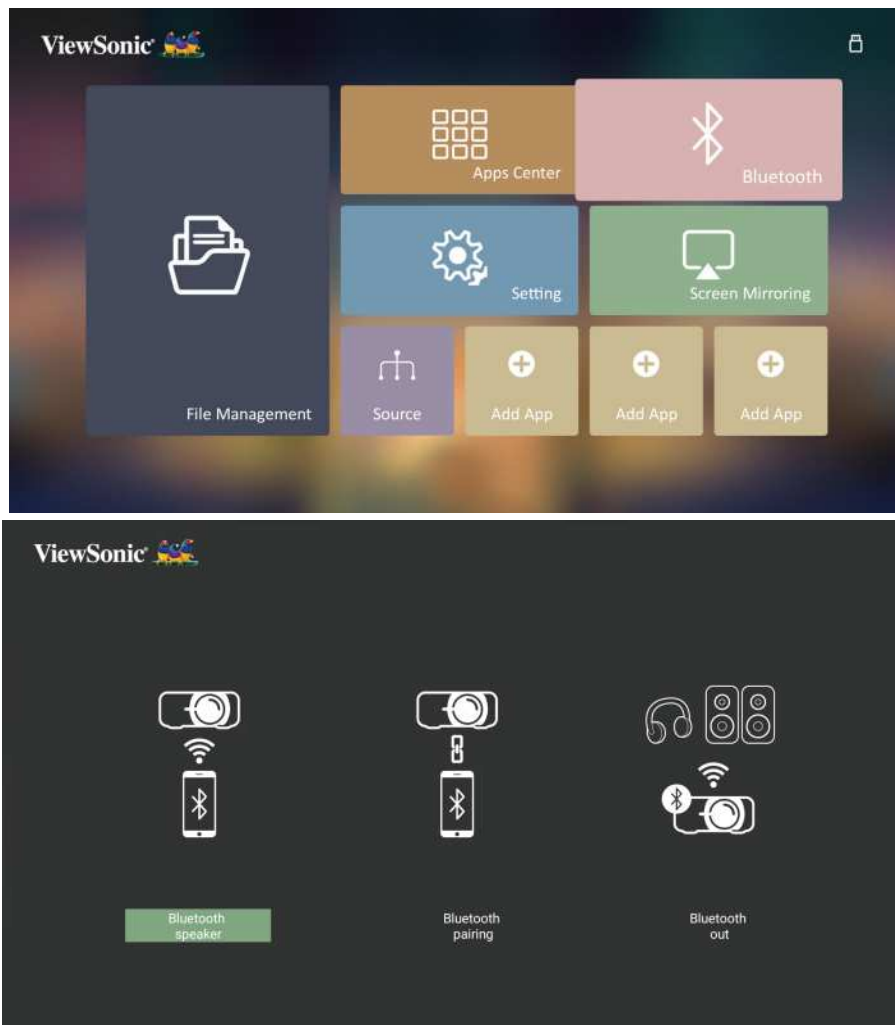

To connect and pair your device:

1. Go to: **Home Screen > Bluetooth.**
2. Use the ◀/▶ to select **Bluetooth Speaker** or **Bluetooth Pairing**. Then press **ENTER/OK**.
3. A dialogue box appears, select **Connect** and press **ENTER/OK** to enter Bluetooth mode.
4. A sound effect will be audible upon entering pairing mode.
5. Upon successful connection, another sound effect will be audible.

**NOTE:** The projector's name will be labeled as "ViewSonic Projector". Once paired, if both the projector and your device are powered on they will automatically connect via Bluetooth in **Bluetooth Speaker** mode. When connected please note that only the ⏻ Power, **Exit** and the ↶ buttons can exit Bluetooth mode.

6. The projector will search for nearby Bluetooth devices. Select your device from

the list and press **ENTER/OK**.

You can also connect the projector to external headphones or speakers that support Bluetooth:

**1. Go to: Home Screen > Bluetooth.**

**2. Use the ◀/▶ to select **Bluetooth Out**. Then press **ENTER/OK**.**

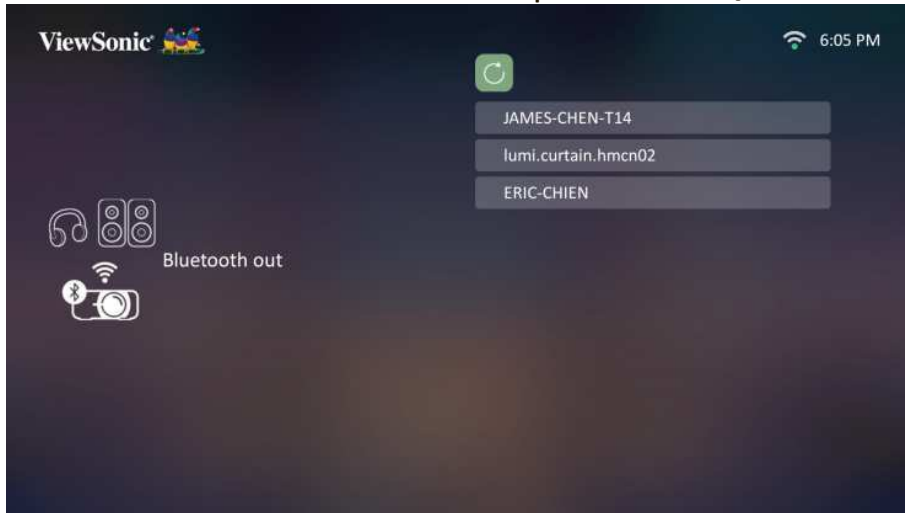

**NOTE:** Once paired, if both the projector and your device are powered on they will automatically connect via Bluetooth.

**NOTE:** The **Bluetooth Out** function is only available when the input source is **Smart System**. It is not available for the HDMI/USB C source.

**NOTE:** When the input source is HDMI/USB C, remember to turn off the connected bluetooth device to avoid listening to two sounds at the same time.



## Setting

Under **Setting** you can adjust Network, Basic, and Advanced Settings, Date & Time, Firmware Update, and view Information.

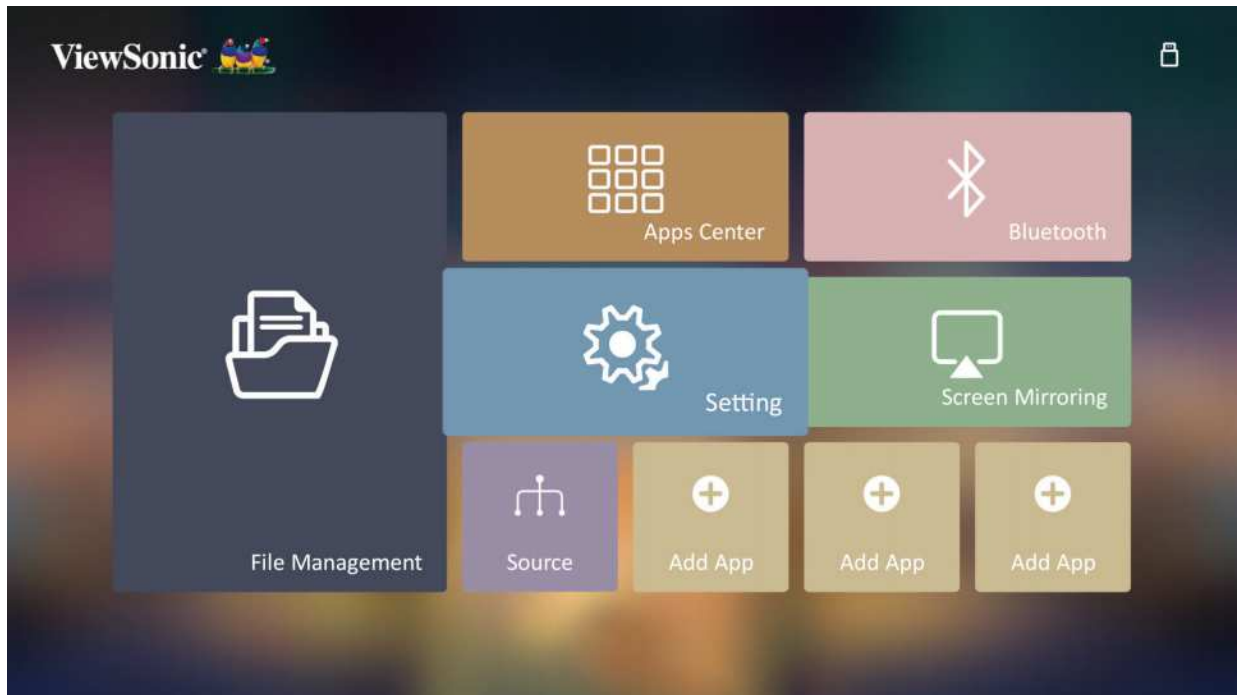

## Network Settings

1. Select: **Home** > **Setting** > **Network Settings**.

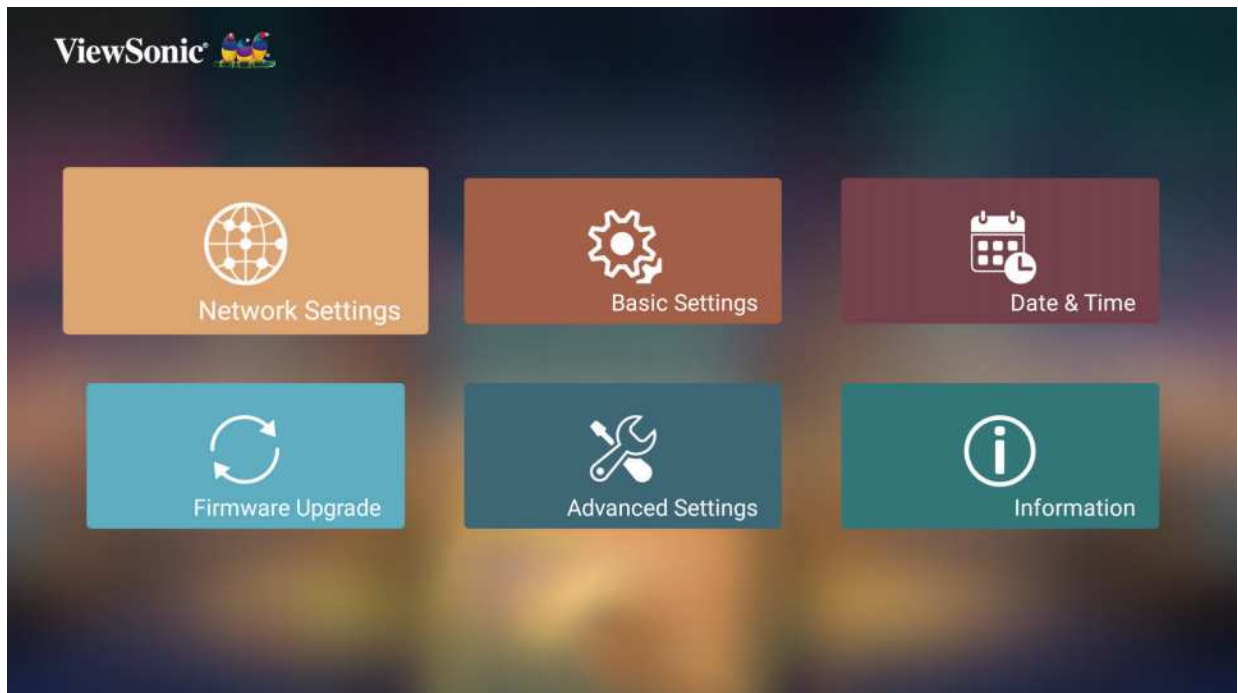

2. Choose Wi-Fi.



3. Use the ◀ Left/ ▶ Right buttons to choose **Enable**.

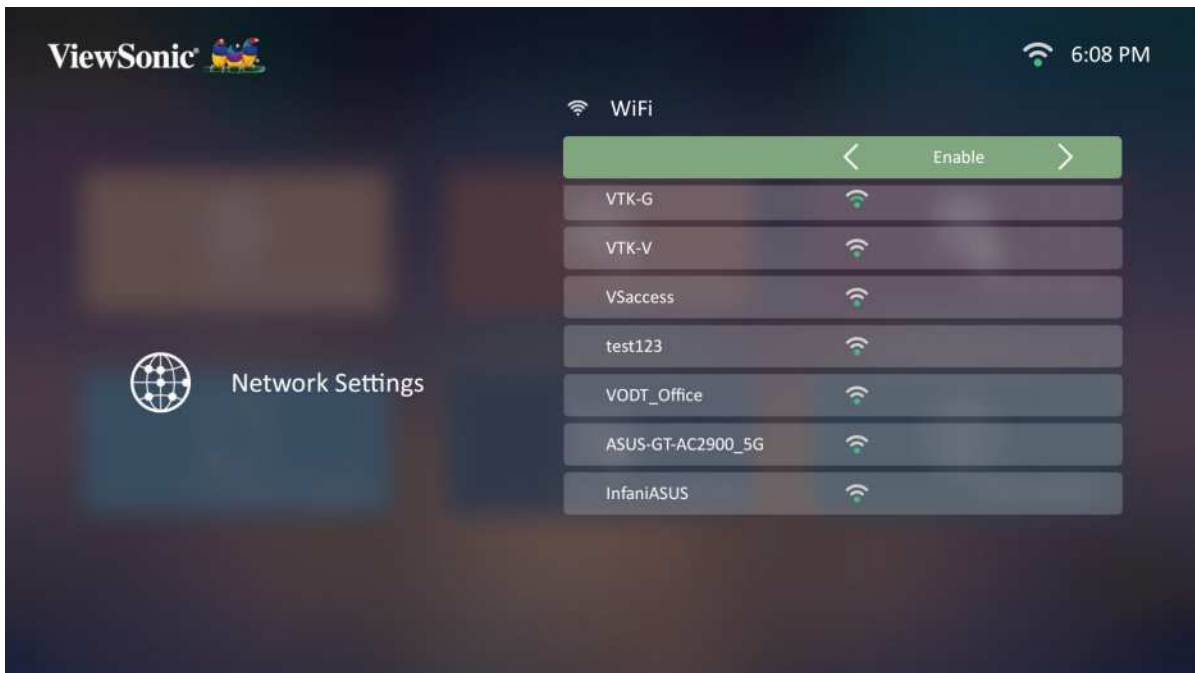

4. The available networks appears. Choose a Wi-Fi network.

5. If a secure Wi-Fi network is connected, input the password when required.

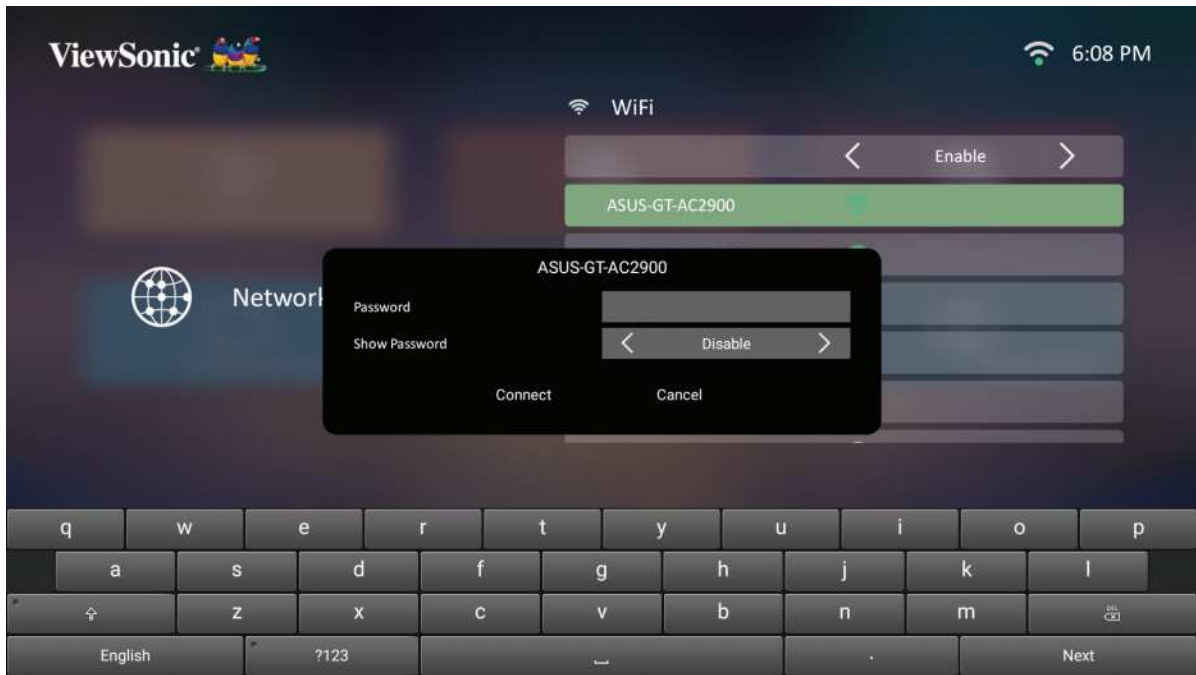

## Custom SSID

1. Go to: **Home > Settings > Network Settings > Wi-Fi**
2. Press **Left** or **Right** on the remote control to select **Enable**.
3. From the available Wi-Fi networks list select **Others** and press **OK** on the remote control.

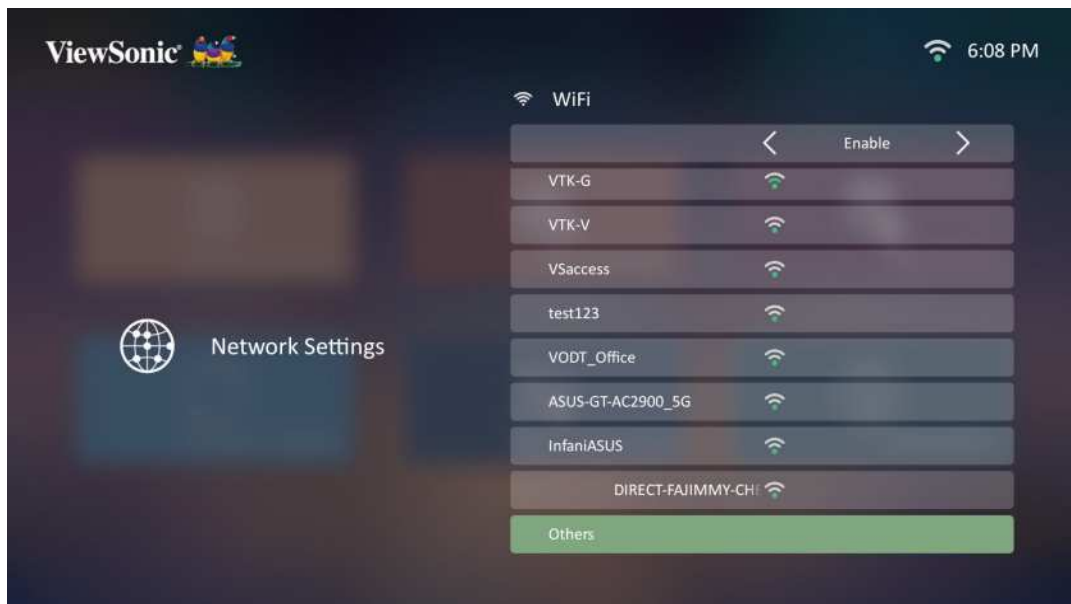

4. Enter the SSID and select the security level.



5. Enter the password when prompted.



## Basic Settings

1. Select: **Home > Setting > Basic Settings.**

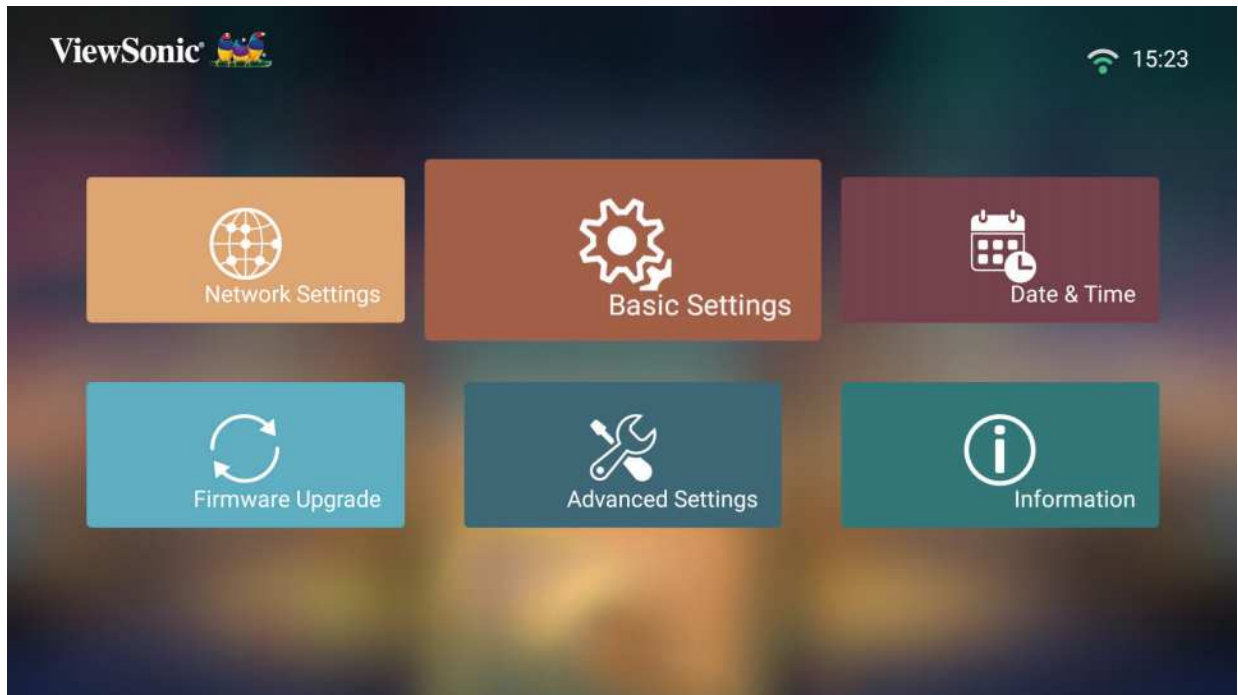

2. Use the **Up** and **Down** buttons to select the desired option and press **OK**. Then use the **Left** and **Right** buttons to make adjustments or selections.

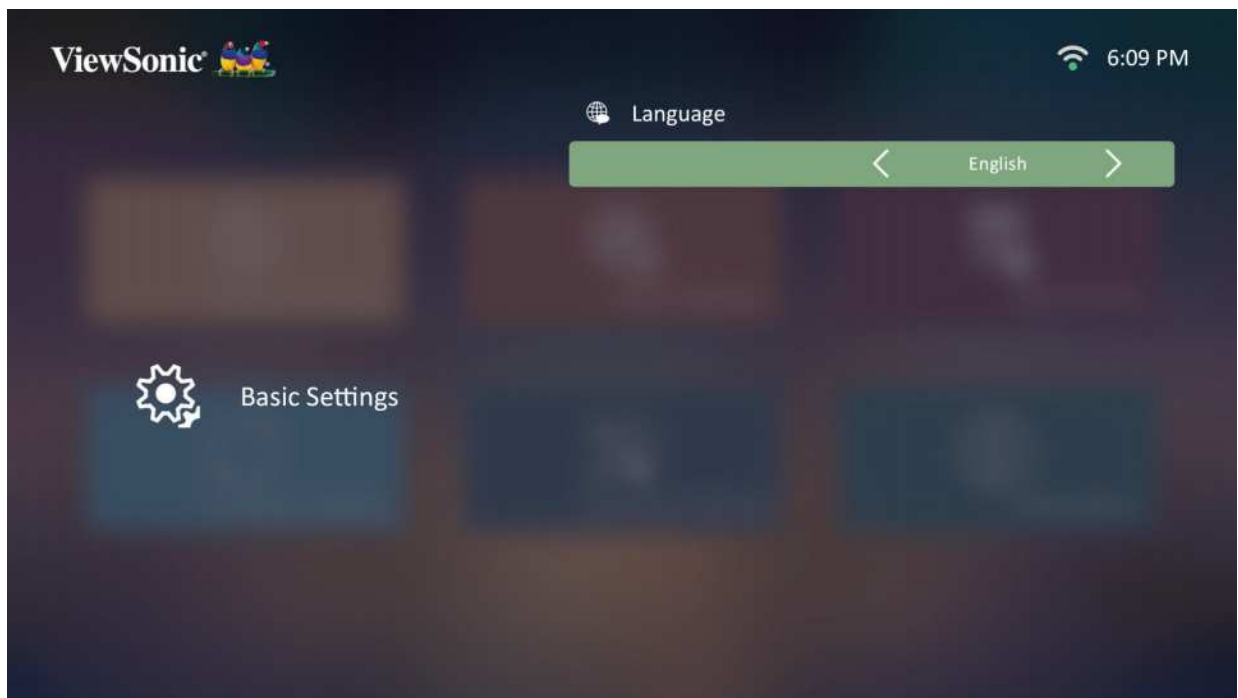

3. To return to a previous menu press the **Return** button.

Menu	Description
Language	Select your desired language.

## Date & Time

Adjust Date, Time, Time Zone, and Time Format.

**NOTE:** The time is displayed in the top-right corner after connecting to the Internet.

1. Select: **Home > Setting > Date & Time.**

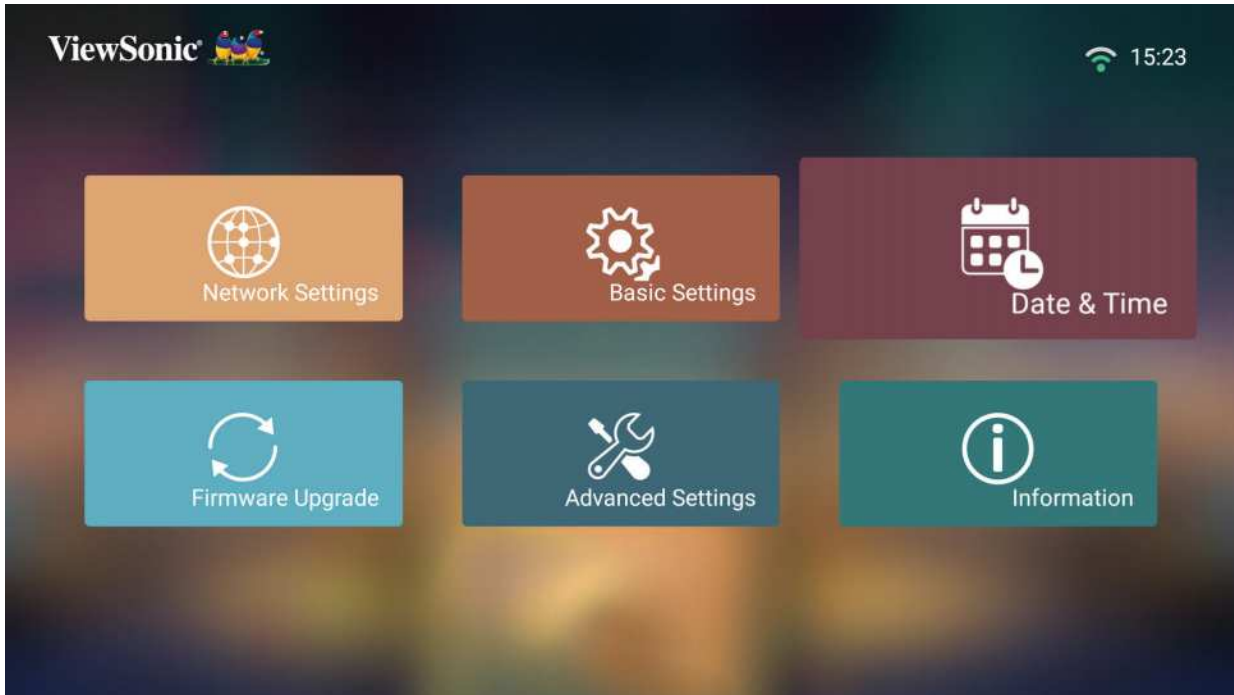

2. Use the **Up** and **Down** buttons to select the desired option and press **OK**. Then use the **Left** and **Right** buttons to make adjustments or selections.

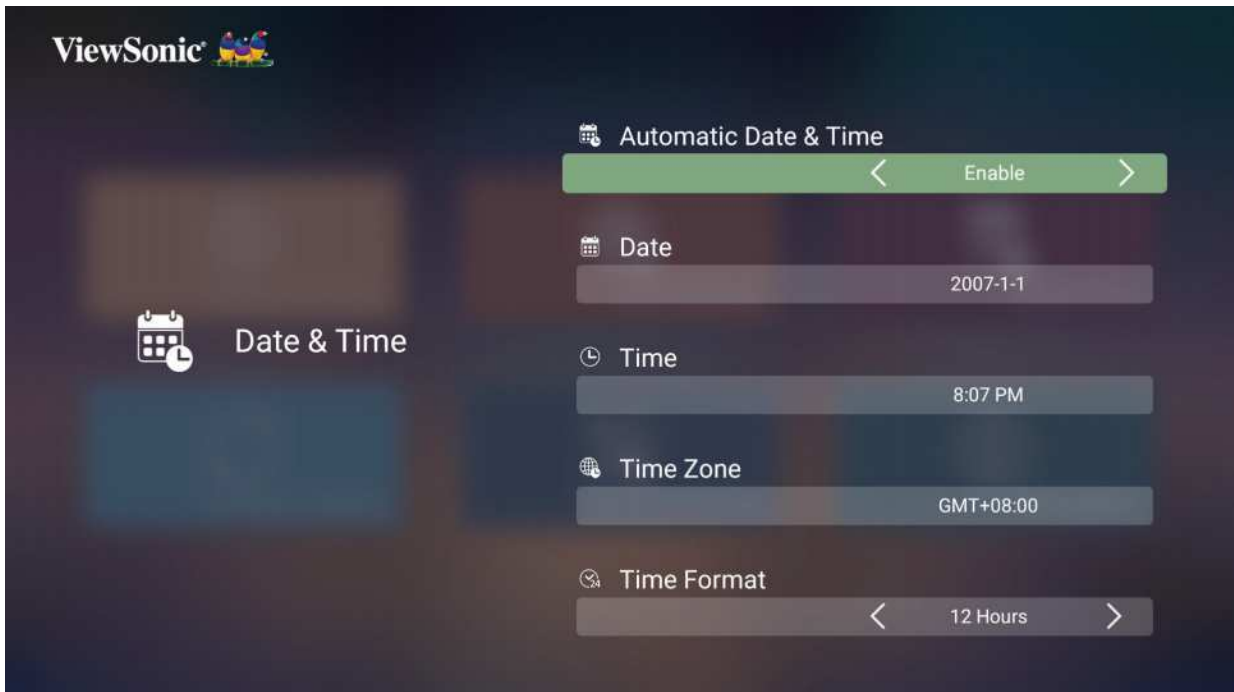

Menu	Description
Automatic Date & Time	<p>Users can synchronize the date and time automatically after connecting to the Internet.</p> <p><b><u>Enable</u></b> Turn on synchronization.</p> <p><b><u>Disable</u></b> Turn off synchronization.</p>
Date	Adjust the date automatically when connected to a network.
Time	Adjust the time automatically when connected to a network.
Time Zone	Select your desired location.
Time Format	<p>Select a different display time format.</p> <p><b><u>12 Hours</u></b> 12-hour clock.</p> <p><b><u>24 Hours</u></b> 24-hour clock.</p>

## Firmware Upgrade

Users can update the firmware by internet or USB, and check the version number.

**NOTE:** Do not unplug the power cord, USB, or disconnect from the Internet during the upgrading process.

1. Before entering the **Firmware Upgrade** menu, ensure the projector is connected to the Internet.
2. To enter the menu, select: **Home > Setting > Firmware Upgrade**.

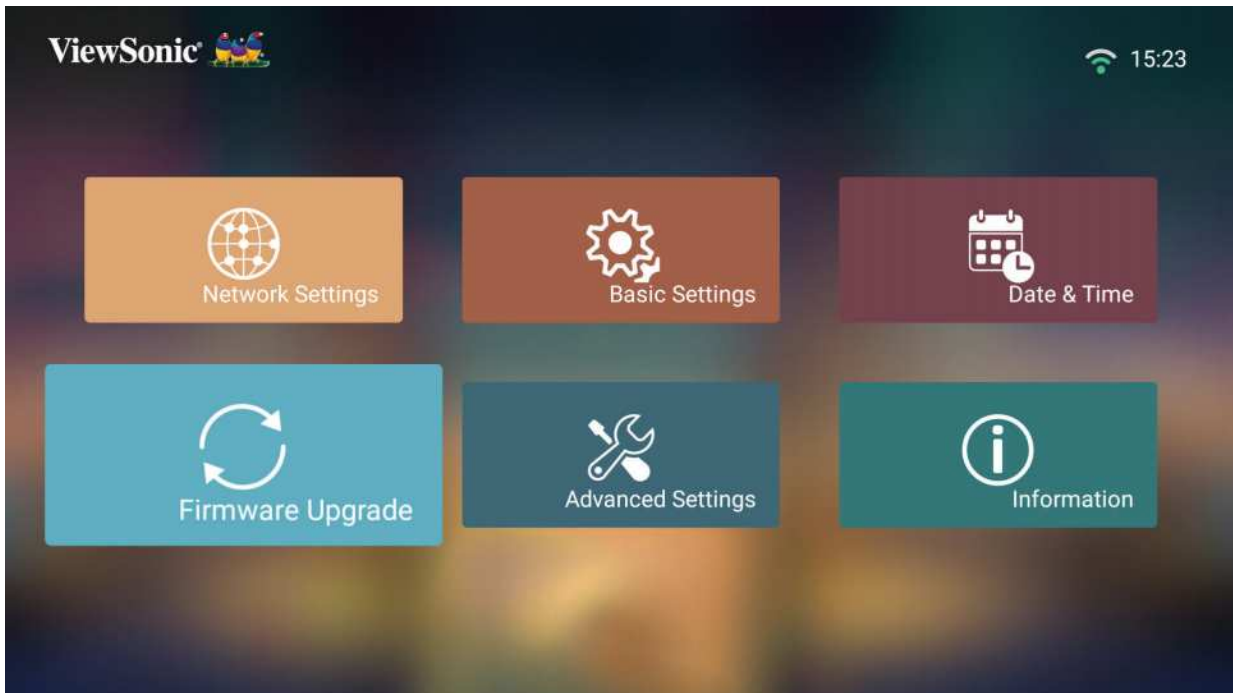

## Firmware Update Online

1. Go to: **Home > Setting > Firmware Upgrade > Software Update Online**.

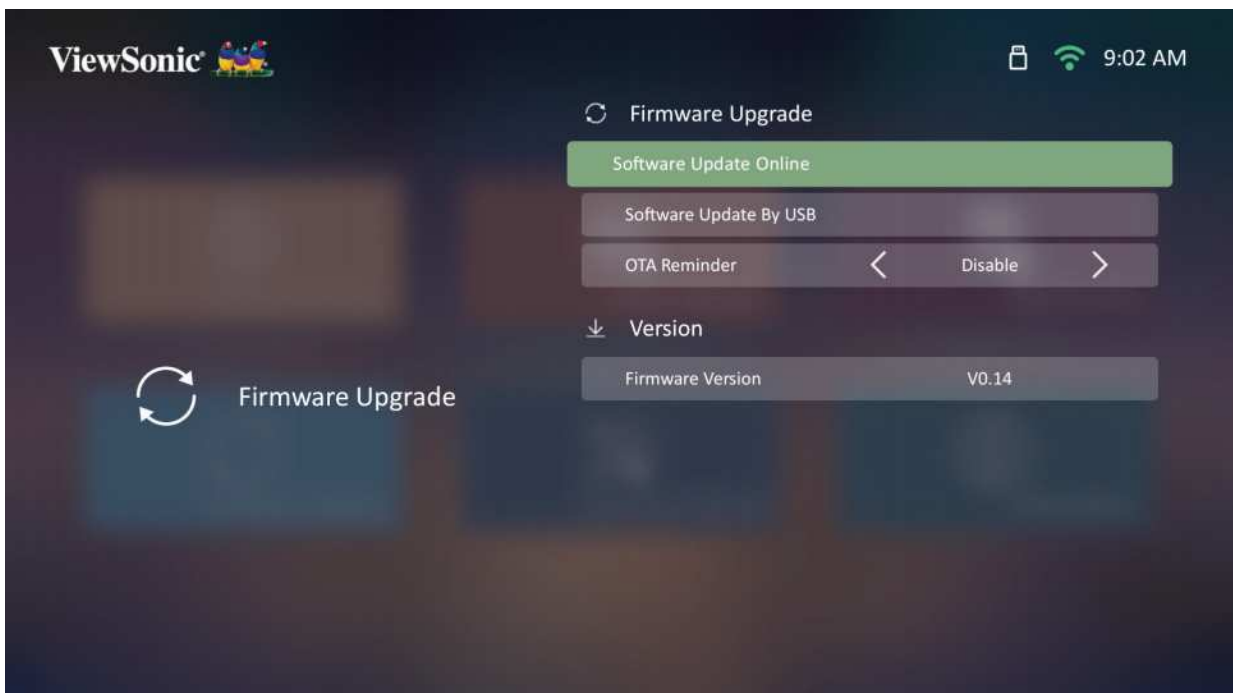

2. Select **Enter** by pressing **OK** on the remote control.



3. The system will check the ViewSonic website (OTA) and display the below dialog message if there is new Firmware.

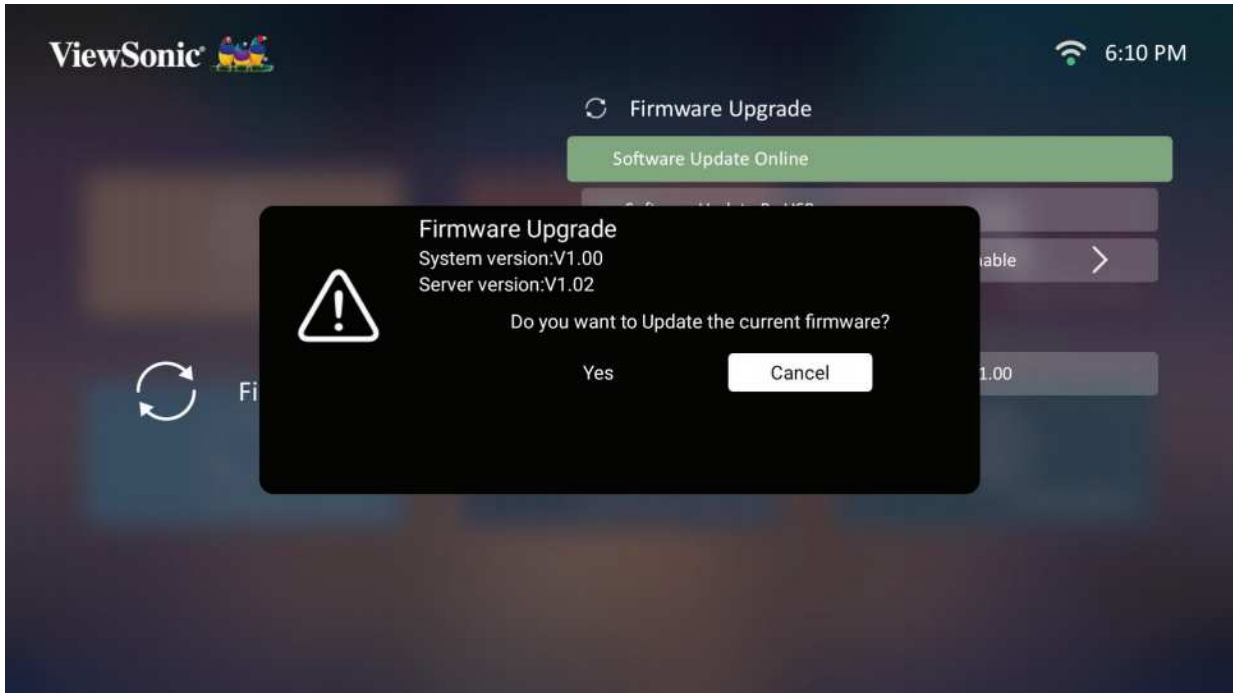

4. After selecting **Yes**, a progress bar will appear as the update process begins.

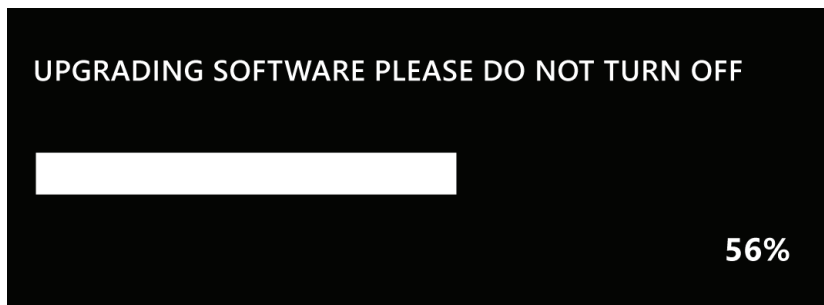

5. After reaching 100% the projector will restart and the screen will turn to black for a few minutes. The whole process will take about 10 minutes.

6. After updating the Firmware, it will take a few minutes to restart the projector.

## Firmware Update by USB with FAT32 Format

**NOTE:** NTFS format, read only.

1. Download the latest version from the ViewSonic website and copy the file to a USB device.
2. Plug the USB into the projector, then go to: **Home > Setting > Firmware Upgrade > Software Update By USB.**
3. Select **Enter** by pressing **OK** on the remote control.
4. The system will detect the Firmware version and display the above dialog message.
5. After selecting **Yes**, a progress bar will appear as the update process begins.
6. After reaching 100% the projector will restart and the screen will turn black for a few minutes. The whole process will take about 10 minutes.
7. After updating the Firmware, it will take a few minutes to restart the projector.

## Advanced Settings

1. Select: **Home > Setting > Advanced Settings.**

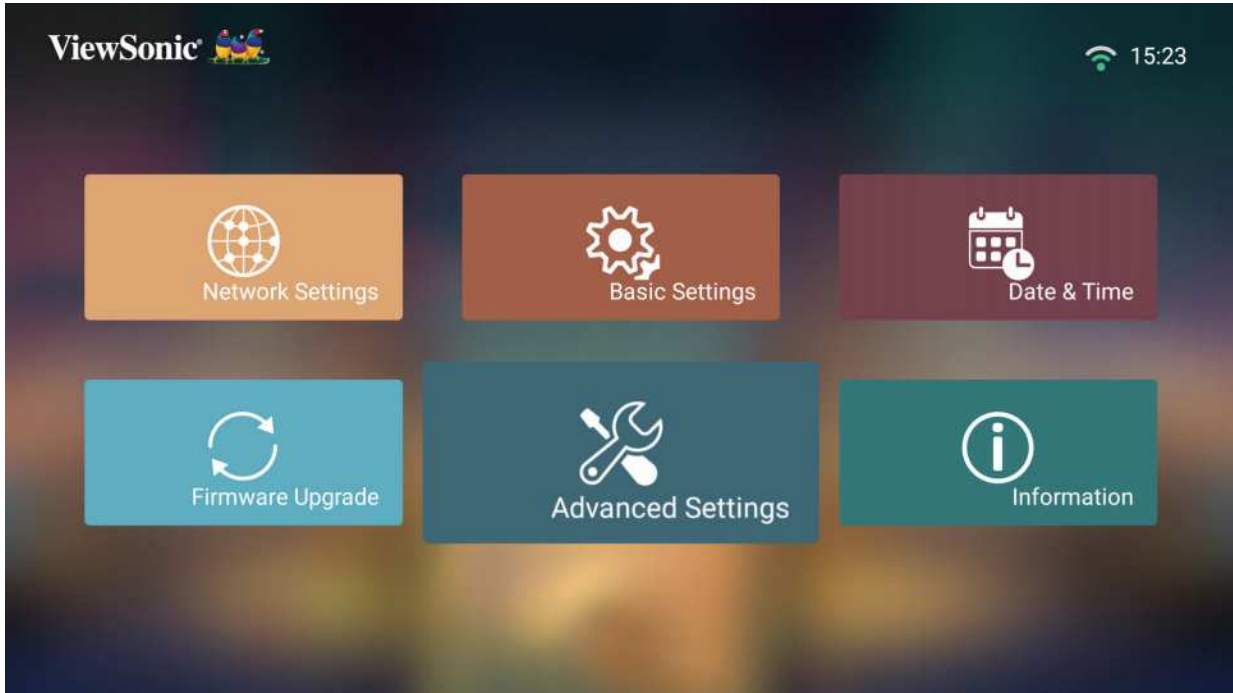

2. Use the **Up** and **Down** buttons to select the desired option and press **OK**. Then use the **Left** and **Right** buttons to make adjustments or selections.

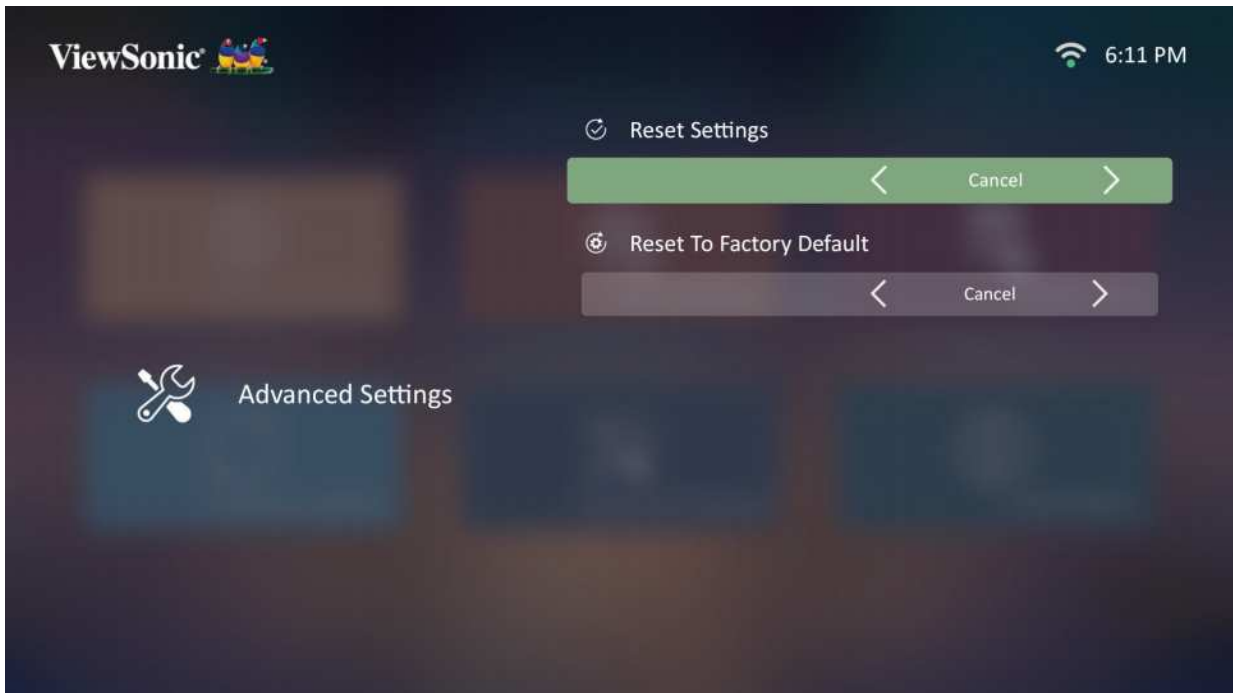

3. To return to a previous menu press the **Return** button.

Menu	Description
Reset Settings	Resets the WiFi and Bluetooth settings.
Reset to Factory Default	Factory reset.

## Information

1. Select: **Home** > **Setting** > **Information**.

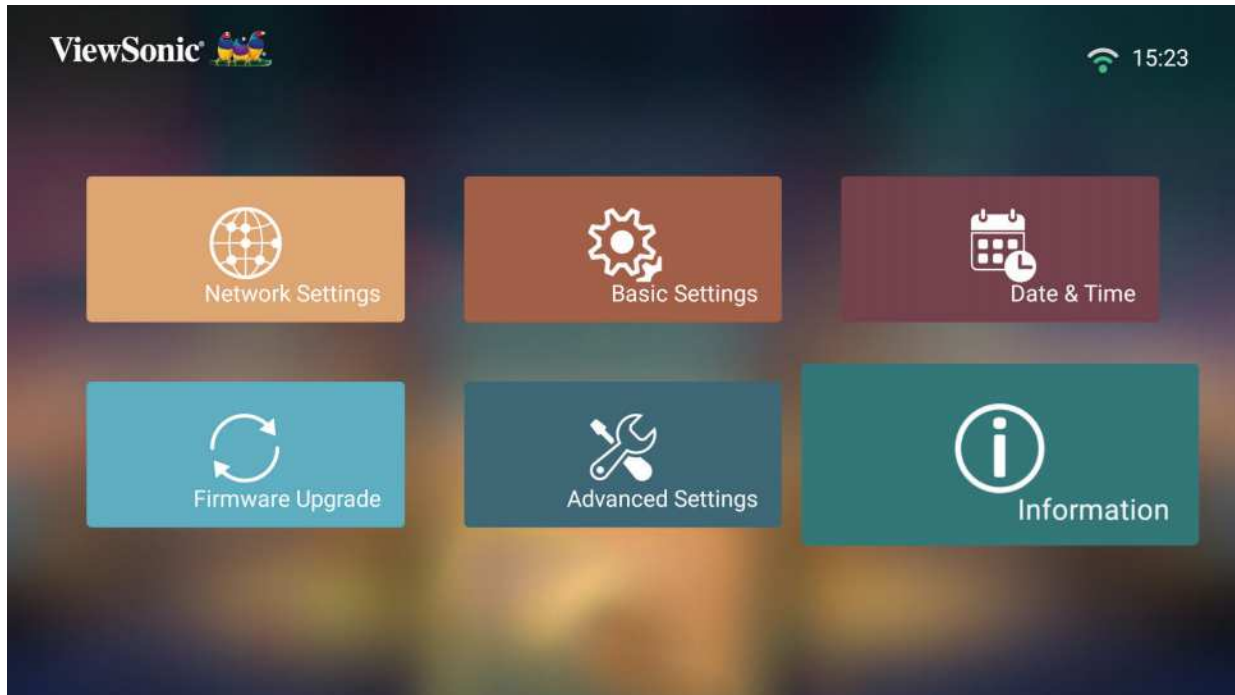

2. View system status and information.

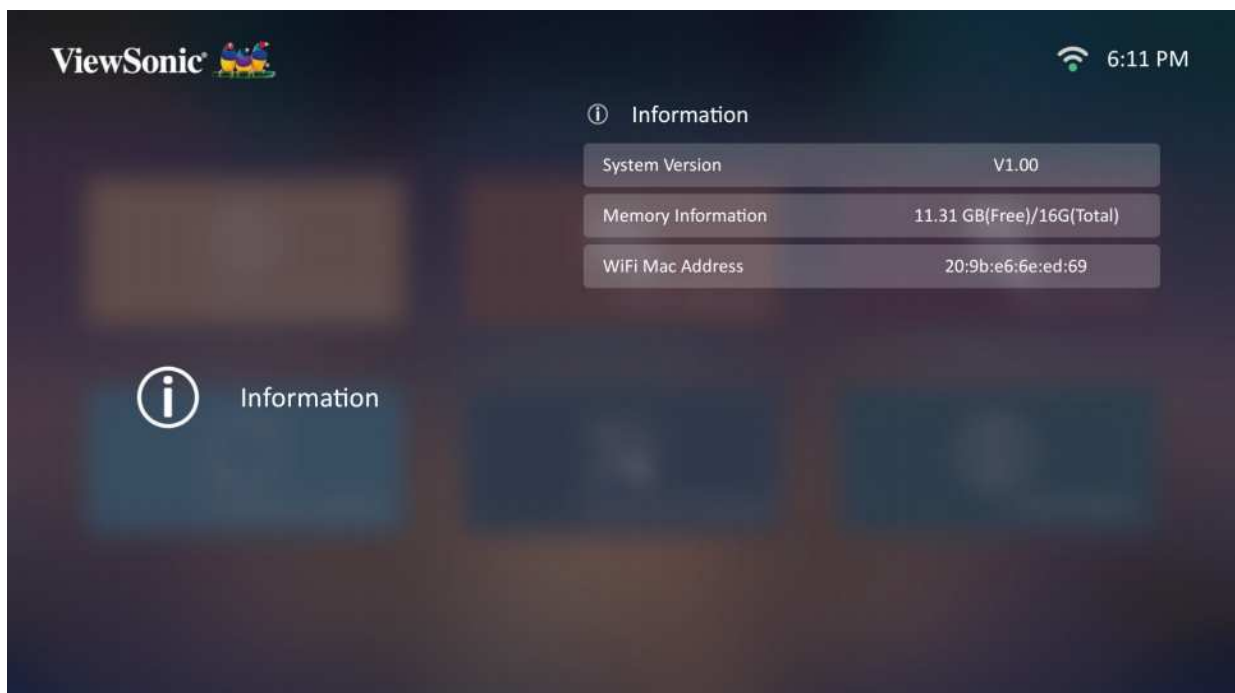

**NOTE:** Press the **Home** button on the remote control to return to the **Home Screen** at anytime.

## Screen Mirroring

Mirror your personal device's screen.

**NOTE:** Ensure your device is connected to the same network as the projector.

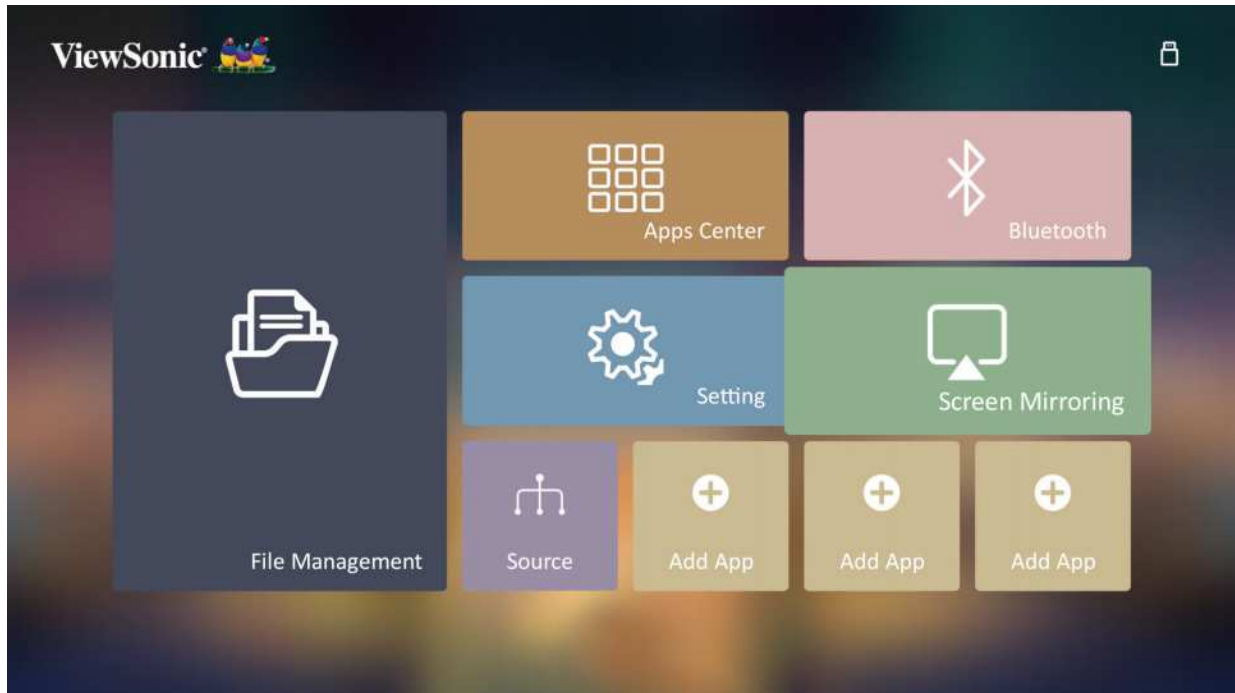

Screen Mirroring provides a 5GHz Wi-Fi connection for users to mirror the screen on their personal device.

**NOTE:** Ensure your device is connected to the same network as the projector.



For iOS:

3. Access the drop down control menu.

4. Select the “Screen Mirroring” icon.

5. Choose “ViewSonic PJ-XXXX”.

**For Android:**

1. Download and install the “Google Home” application and open it.

2. Pull-to-refresh the app and wait for 30 seconds.

3. “ViewSonic PJ-XXXX” will now be visible, select it.

**NOTE:** Some Android devices support direct “Casting”. If your device does, go to the Casting feature and choose “ViewSonic PJ-XXX” from the list of available devices. You can also scan the FAQ QR code and follow the steps to directly cast your Android device.

## Adding Apps

Add your favorite Apps to the **Home Screen**.

1. From the **Home Screen**, select **Add App** and then press **OK** on the remote control.

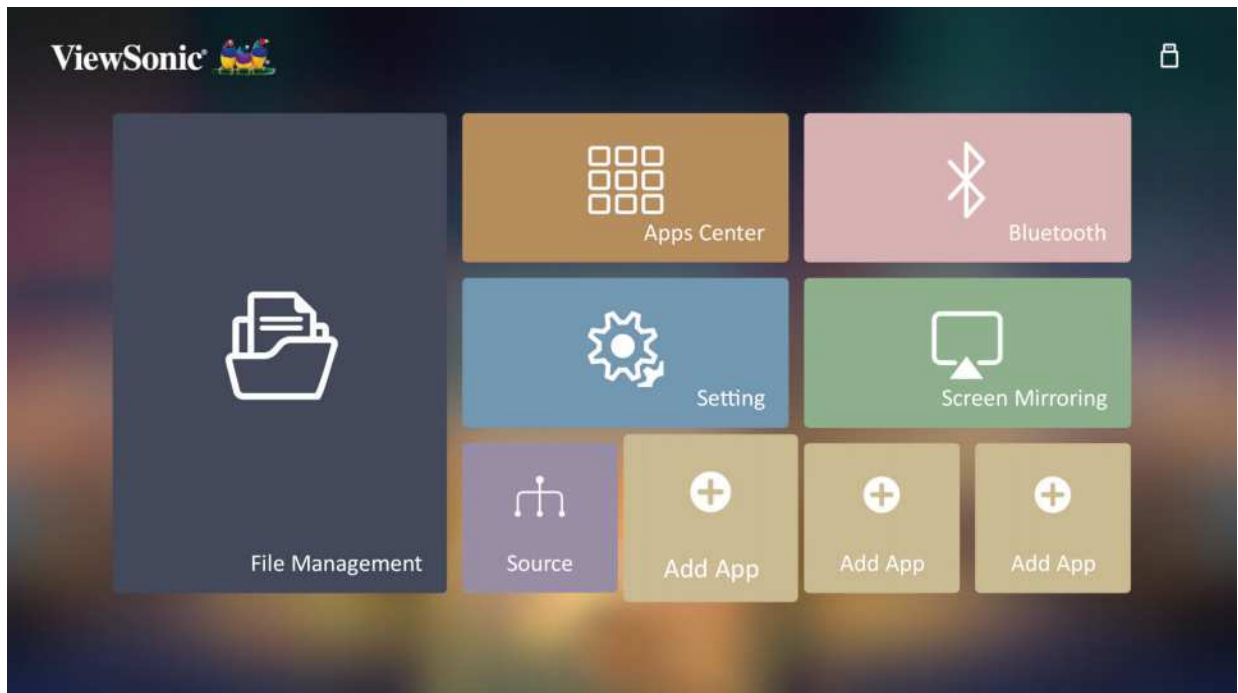

2. Use the directional buttons to select the desired App and press **OK**.

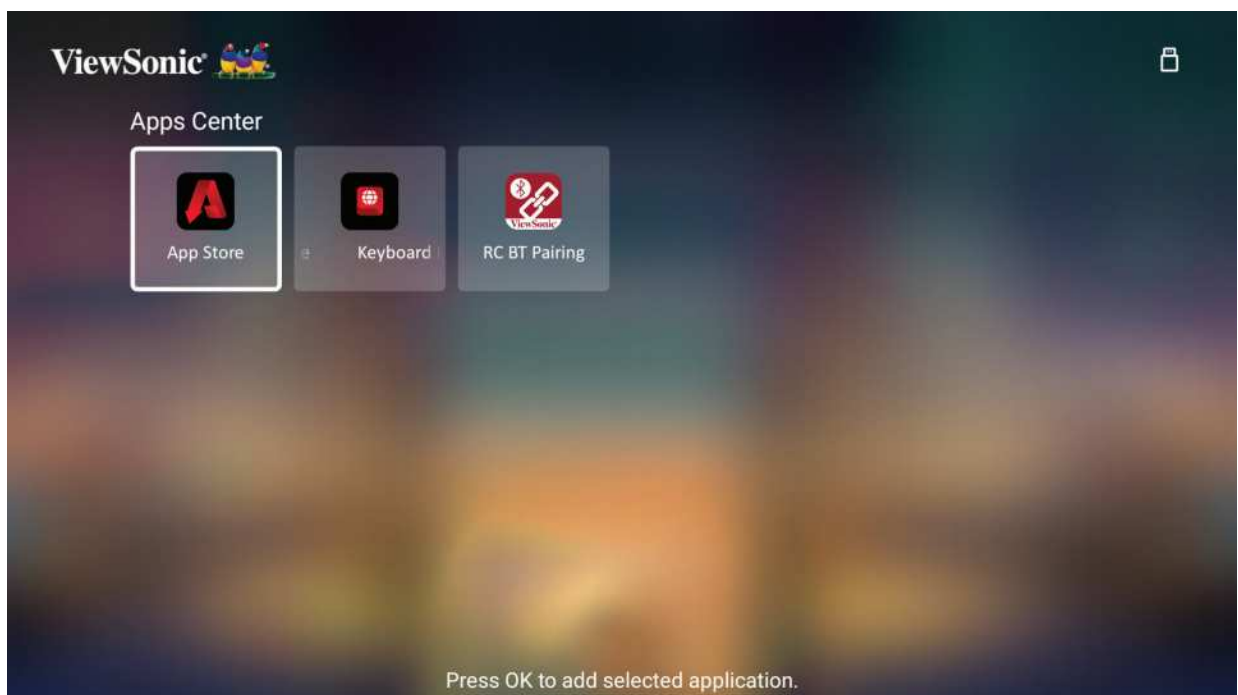

3. Now your favorite App will appear on the **Home Screen**.

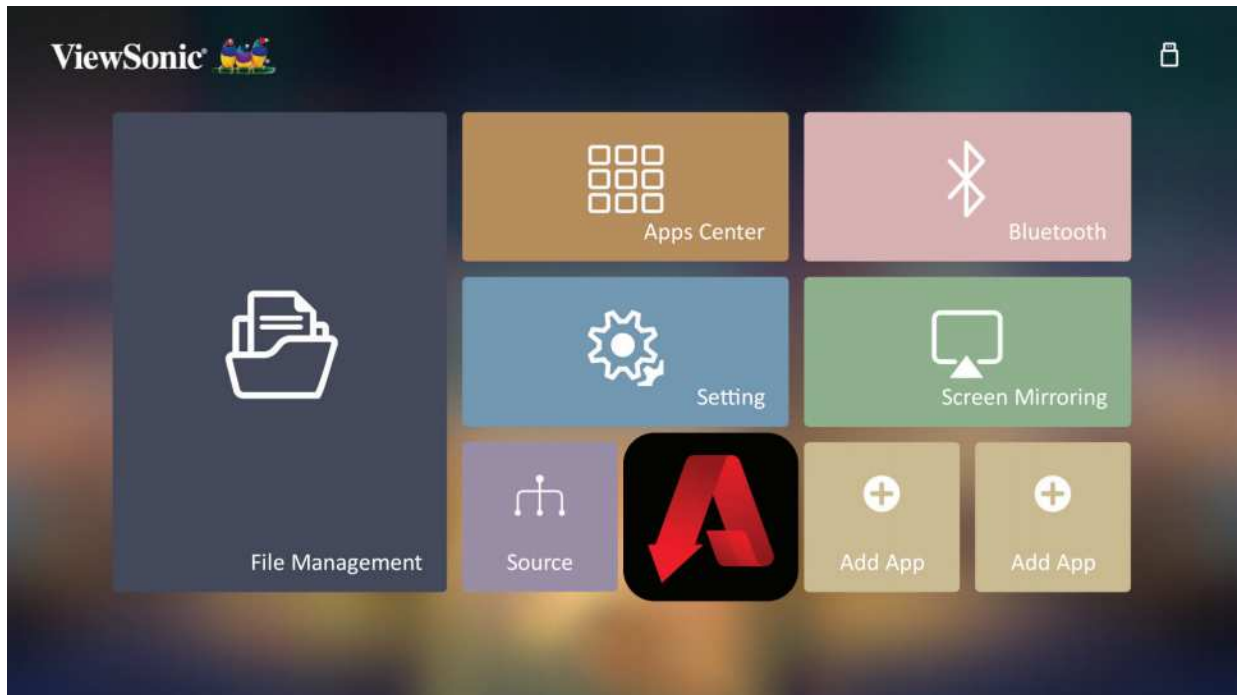

### Delete Apps From the Home Screen

1. From the **Home Screen**, select the App you want to delete and press and hold **OK** for three (3) seconds.
2. The message, “Do you want Delete this application from My Favorites?” will appear.

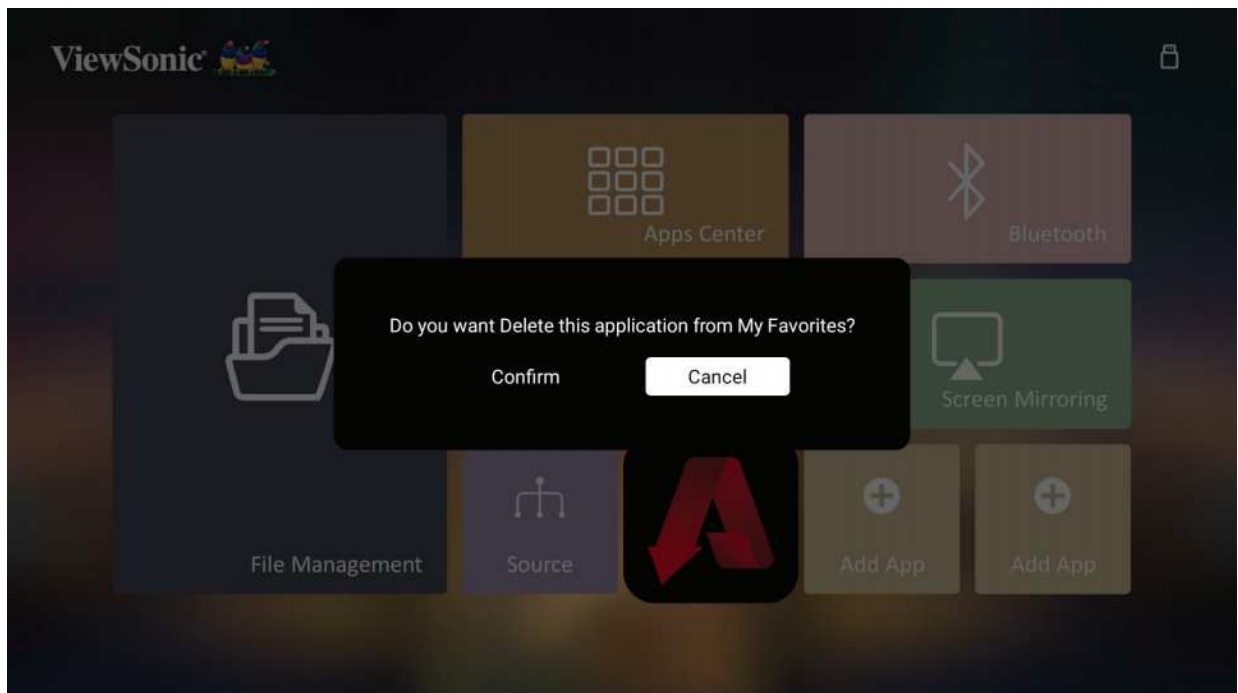

3. Select **Yes**, and press **OK** to delete the App.



# Appendix

## Specifications

Item	Category	Specifications	
		X1-4K	X2-4K
Projector	Type	0.65" 4K UHD, LED	
	Display Size	60"~150"	60"~120"
	Throw Ratio	1.15~1.5 (95"±3%@2.41m)	0.69~0.83 (95"±3%@1.44m)
	Lens	F = 2.48 – 2.78	F = 2.53 – 2.73
	Optical Zoom	1.3x±3%	1.2x±3%
	Light Source Type	LED	
	Display System	1-CHIP DMD	
Input signal	HDMI	f <sub>h</sub> : 15K~135KHz, f <sub>v</sub> :23~240Hz, Max. pixel rate: 600MHz	
Resolution	Native	3840 x 2160	
Power adapter <sup>1</sup>	Input Voltage	AC 100-240V, 50/60 Hz (auto switch)	
Operating conditions	Temperature	0°C to 40°C (32°F to 104°F)	
	Humidity	10% to 90% (non-condensing)	
	Altitude	0 to 1,499 m at 0°C to 35°C 1,500 to 3,000 m at 0°C to 30°C	
Storage conditions	Temperature	-20°C to 60°C (non-condensing)	
	Humidity	10% to 90% (non-condensing)	
	Altitude	0 to 12,200 m at 30°C	
Dimensions	Physical (W x H x D)	355 x 121 x 244 mm (14" x 4.8" x 9.6")	355 x 121 x 251 mm (14" x 4.8" x 9.9")
Weight	Physical	3.6±0.2 kg (7.94±0.44 lb)	
Power consumption	On <sup>2</sup>	236 W (Typical)	
	Off	< 0.5W (Standby)	

<sup>1</sup> Please use the power adapter from ViewSonic® or an authorized source only.

<sup>2</sup> The test condition follows EEI standards.

## Projector Dimensions

### X1-4K

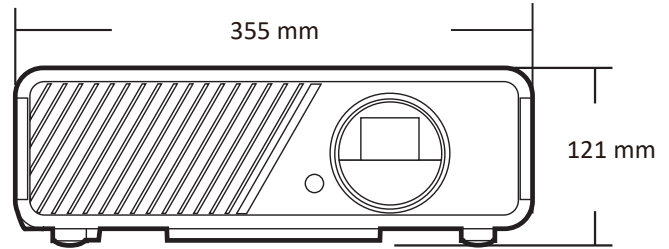
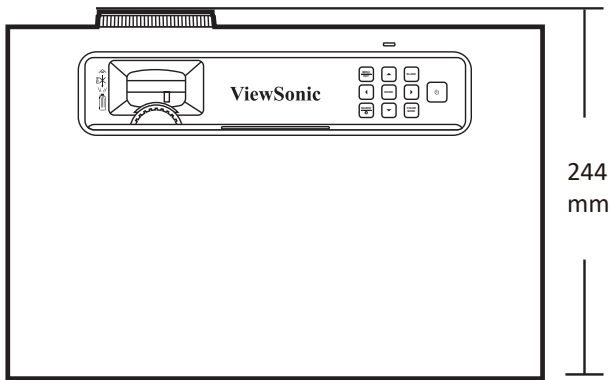

### X2-4K

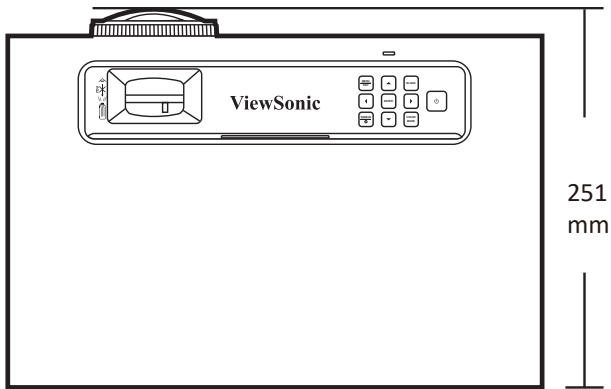

## Timing Chart

HDMI/USB C (PC)			
Signal	Resolution (dots)	Aspect ratio	Refresh rate (Hz)
VGA	640 x 480	4:3	60/72/75/120
SVGA	800 x 600	4:3	60/72/75/120
XGA	1024 x 768	4:3	60/70/75/120
	1152 x 864	4:3	75
HD	1280x 720	16:9	60/120
WXGA	1280 x 768	15:9	60
	1280 x 800	16:10	60/75/120
	1366 x 768	16:9	59.7
Quad-VGA	1280 x 960	4:3	60
SXGA	1280 x 1024	5:4	60/75
SXGA+	1400 x 1050	4:3	60
WXGA+	1440 x 900	16:10	60
UXGA	1600 x 1200	4:3	60
WSXGA+	1680 x 1050	16:10	60
WUXGA	1920 x 1200	16:10	60
MAC 13"	640 x 480	4:3	67
MAC 16"	832 x 624	4:3	75
MAC 19"	1024 x 768	4:3	75
MAC 21"	1152 x 870	4:3	75
HDTV (1080p)	1920 x 1080	16:9	60/120/240
1440p	2560 x 1440	16:9	60/120RB
4K UHD	3840 x 2160	16:9	30/60

HDMI/USB C (Video)			
Signal	Resolution (dots)	Aspect ratio	Refresh rate (Hz)
HDTV (4K)	3840 x 2160	16:9	24 / 25 / 30 / 50 / 60
HDTV (1440p)	2560 x 1440	16:9	60/120RB
HDTV (1080p)	1920 x 1080	16:9	24
HDTV (1080p)	1920 x 1080	16:9	50 / 60
HDTV (1080i)	1920 x 1080	16:9	50 / 60
HDTV (720p)	1280 x 720	16:9	50 / 60
SDTV (480p)	720 x 480	4:3 / 16:9	60
SDTV (576p)	720 x 576	4:3 / 16:9	50

HDMI/USB C (Video)			
Signal	Resolution (dots)	Aspect ratio	Refresh rate (Hz)
SDTV (480i)	720 x 480	4:3 / 16:9	60
SDTV (576i)	720 x 576	4:3 / 16:9	50

3D (HDMI signal included)			
Signal	Resolution (dots)	Aspect ratio	Refresh rate (Hz)
Signal	Resolution (dots)	Aspect Ratio	Refresh Rate (Hz)
SVGA	800 x 600	4:3	60* / 120**
XGA	1024 x 768	4:3	60* / 120**
HD	1280 x 720	16:9	60* / 120**
WXGA	1280 x 800	16:9	60* / 120**
HDTV (1080p)	1920 x 1080	16:9	60
<p><b>NOTE:</b> *50Hz and 60Hz signals are supported for Side-by-Side, Top-Bottom, and Frame Sequential formats.</p> <p><b>NOTE:</b> **120 Hz signals are supported for Frame Sequential format only.</p>			

HDMI 3D			
Signal	Resolution (dots)	Aspect ratio	Refresh rate (Hz)
<b>In Frame Packing format</b>			
1080p	1920 x 1080	16:9	23.98/24
720p	1280 x 720	16:9	50/59.94/60
<b>In Side-by-Side format</b>			
1080i	1920 x 1080	16:09	50/60
1080p	1920 x 1080	16:09	50/60
<b>In Top-Bottom format</b>			
1080p	1920 x 1080	16:9	24/50/60
720p	1280 x 720	16:9	50/60
576p	720 x 576	16:9	60
480p	720 x 480	16:9	59.94

# Troubleshooting

## Common Problems

This section describes some common problems that you may experience when using the projector.

Problem	Possible Solutions
The projector does not turn on	<ul style="list-style-type: none"><li>• Ensure the power cord is properly attached to the projector and to the power outlet.</li><li>• If the cooling process has not completed, please wait until it has finished then try to turn on the projector again.</li><li>• If the above does not work, try another power outlet or another electrical device with the same power outlet.</li></ul>
There is no picture	<ul style="list-style-type: none"><li>• Ensure the video source cable is connected properly, and that the video source is turned on.</li><li>• If the input source is not selected automatically, select the correct source with the <b>Source</b> key on either the projector or the remote control.</li></ul>
The image is blurred	<ul style="list-style-type: none"><li>• Adjusting the <b>Focus Ring</b> will help correctly focus the projection lens.</li><li>• Ensure the projector and screen are aligned properly. If necessary, adjust the height of the projector as well as the projection angle and direction.</li></ul>
The remote control does not work	<ul style="list-style-type: none"><li>• Ensure there are no obstacles between the remote control and projector; and that they are within 8 m (26 ft) of each other.</li><li>• The batteries may be out of power, please check and replace if necessary.</li></ul>
The image abnormal	<ul style="list-style-type: none"><li>• Ensure the video source cable is connected properly, and that the video source is turned on.</li><li>• If the above does not work, check the air intake or exhaust not block.</li></ul>
Bluetooth or WiFi connection fails	<ul style="list-style-type: none"><li>• Perform <b>Reset Wi-Fi mobile &amp; Bluetooth</b> in the <b>Settings &gt; Advance Settings &gt; Reset Settings</b> menu when the input source is <b>SMART SYSTEM</b>.</li><li>• Turn off the Wifi function and then turn on again in the <b>Settings &gt; Network Settings &gt; WiFi</b> menu</li></ul>

## LED Indicator

Light	Status and Description
Orange	Stand-by mode
Green Flashing	Powering up
Green	Normal operation
Red	Downloading
Orange Flashing	Burn in off
Red Flashing once per second	Fan error
Red Flashing once per 3 seconds	Thermal and temperature error
Green & Red Flashing alternately	Light source error

# Maintenance

## General Precautions

- Make sure the Projector is turned off and the power cable is unplugged from the power outlet.
- Never remove any parts from the Projector. Contact ViewSonic® or a reseller when any part of the Projector needs replacing.
- Never spray or pour any liquid directly onto the case.
- Handle the Projector with care, as a darker-colored projector, if scuffed, may show marks more clearly than a lighter-colored projector.

## Cleaning the Lens

- Use a canister of compressed air to remove dust.
- If the lens is still not clean, use lens-cleaning paper or moisten a soft cloth with lens cleaner and gently wipe the surface.

**CAUTION:** Never rub the lens with abrasive materials.

## Cleaning the Case

- Use a soft, lint-free, dry cloth to remove dirt or dust.
- If the case is still not clean, apply a small amount of non-ammonia, non-alcohol based, mild non-abrasive detergent onto a clean, soft, lint-free cloth, then wipe the surface.

**CAUTION:** Never use wax, alcohol, benzene, thinner, or other chemical detergents.

## Storing the Projector

If you intend to store the Projector for an extended period of time:

- Ensure the temperature and humidity of the storage area are within the recommend range.
- Retract the adjuster foot completely.
- Remove the batteries from the Remote Control.
- Pack the Projector in its original packaging or equivalent.

## Disclaimer

- ViewSonic® does not recommend the use of any ammonia or alcohol-based cleaners on the lens or case. Some chemical cleaners have been reported to damage the lens and/or case of the projector.
- ViewSonic® will not be liable for damage resulting from use of any ammonia or alcohol-based cleaners.

## Light Source Information

This section will provide a better understanding of your projector's light source.

### Light Source Hour

When the projector is being used, the duration (in hours) of light source usage is automatically calculated by the built-in timer.

To obtain the light source hour information:

1. Press **Menu** to open the OSD Menu and go to: **Advanced > Light Source Settings > Light Source Hours Information**.
2. Press **Enter** and the **Light Source Hours Information** page will appear.
3. Press **Exit** to leave the menu.

### Extending Light Source Life

To prolong light source life, you can adjust the following settings in the OSD Menu.

### Setting Light Source Mode

Setting the projector in any mode other than **Normal** reduces system noise, power consumption, and extends the light source's operational life.

Light Source Mode	Description
<b>Normal</b>	Provides full light source brightness.
<b>Eco</b>	Reduces light source power consumption by 40% and lowers brightness, and decreases fan noise.
<b>Dynamic Black 1</b>	Reduces light source power consumption by up to 70% depending on the content's brightness level.
<b>Dynamic Black 2</b>	Reduces light source power consumption by up to 50% depending on the content's brightness level.
<b>Custom</b>	Allows you to adjust the light source power to extend the light source life and decreases the fan noise.

To set the Light Source Mode, open the OSD Menu and go to: **Advanced > Light Source Settings > Light Source Mode** and press ◀/▶ to select and press **Enter**.

### Setting Auto Power Off

This allows the projector to turn off automatically after a set period of time once no input source is detected.

Open the OSD Menu and go to: **POWER MANAGEMENT > Smart Energy > Auto Power Off** and press ◀/▶ to disable or adjust the time.



# Regulatory and Service Information

## Compliance Information

This section addresses all connected requirements and statements regarding regulations. Confirmed corresponding applications shall refer to nameplate labels and relevant markings on the unit.

### FCC Compliance Statement

This device complies with part 15 of FCC Rules. Operation is subject to the following two conditions: (1) this device may not cause harmful interference, and (2) this device must accept any interference received, including interference that may cause undesired operation. This equipment has been tested and found to comply with the limits for a Class B digital device, pursuant to part 15 of the FCC Rules.

These limits are designed to provide reasonable protection against harmful interference in a residential installation. This equipment generates, uses, and can radiate radio frequency energy, and if not installed and used in accordance with the instructions, may cause harmful interference to radio communications. However, there is no guarantee that interference will not occur in a particular installation. If this equipment does cause harmful interference to radio or television reception, which can be determined by turning the equipment off and on, the user is encouraged to try to correct the interference by one or more of the following measures:

- Reorient or relocate the receiving antenna.
- Increase the separation between the equipment and receiver.
- Connect the equipment into an outlet on a circuit different from that to which the receiver is connected.
- Consult the dealer or an experienced radio/TV technician for help.

**Warning:** You are cautioned that changes or modifications not expressly approved by the party responsible for compliance could void your authority to operate the equipment.

## **FCC Radiation Exposure Statement**

This equipment complies with FCC radiation exposure limits set forth for an uncontrolled environment. End users must follow the specific operating instructions for satisfying RF exposure compliance.

This transmitter must not be co-located or operating in conjunction with any other antenna or transmitter. This equipment should be installed and operated with a minimum distance of 20 centimeters between the radiator and your body.

The users manual or instruction manual for an intentional or unintentional radiator shall caution the user that changes or modifications not expressly approved by the party responsible for compliance could void the user's authority to operate the equipment.

## **Industry Canada Statement**

CAN ICES-003(B) / NMB-003(B)

## **IC Warning Statement**

This device complies with Industry Canada licence-exempt RSS standard(s). Operation is subject to the following two conditions: (1) This device may not cause interference, and (2) This device must accept any interference, including interference that may cause undesired operation of the device.

Le présent appareil est conforme aux CNR d'Industrie Canada applicables aux appareils radio exempts de licence. L'exploitation est autorisée aux deux conditions suivantes : (1) l'appareil ne doit pas produire de brouillage, et (2) l'utilisateur de l'appareil doit accepter tout brouillage radioélectrique subi, même si le brouillage est susceptible d'en compromettre le fonctionnement.

## **Country Code Statement**

For product available in the USA/Canada market, only channel 1~11 can be operated. Selection of other channels is not possible.

Pour les produits disponibles aux États-Unis/Canada du marché, seul le canal 1 à 11 peuvent être exploités. Sélection d'autres canaux n'est pas possible.

## IC Radiation Exposure Statement

This equipment complied with IC RSS-102 radiation exposure limits set forth for an uncontrolled environment. This equipment should be installed and operated with minimum distance 20cm between the radiator & your body. The device for the band 5150-5825 MHz is only for indoor usage to reduce potential for harmful interference to co-channel mobile satellite systems.

Cet équipement est conforme aux limites d'exposition aux rayonnements IC établies pour un environnement non contrôlé. Cet équipement doit être installé et utilisé avec un minimum de 20cm de distance entre la source de rayonnement et votre corps. Les dispositifs fonctionnant dans la bande 5150-5825 MHz sont réservés uniquement pour une utilisation à l'intérieur afin de réduire les risques de brouillage.

Operation in the band 5150-5250 MHz is only for indoor use to reduce the potential for harmful interference to co-channel mobile satellite systems.

La bande 5 150-5 250 MHz est réservés uniquement pour une utilisation à l'intérieur afin de réduire les risques de brouillage préjudiciable aux systèmes de satellites mobiles utilisant les mêmes canaux.

## CE Conformity for European Countries

**CE** The device complies with the EMC Directive 2014/30/EU and Low Voltage Directive 2014/35/EU. Ecodesign Directive 2009/125/EC and Radio Equipment Directive 2014/53/EU.

Frequency Range: 2400-2483.5MHz, 5150-5250MHz

Max Output Power: under 20dBm

### The following information is only for EU-member states:

The mark shown to the right is in compliance with the Waste Electrical and Electronic Equipment Directive 2012/19/EU (WEEE). The mark indicates the requirement NOT to dispose of the equipment as unsorted municipal waste, but use the return and collection systems according to local law.



## Declaration of RoHS2 Compliance

This product has been designed and manufactured in compliance with Directive 2011/65/EU of the European Parliament and the Council on restriction of the use of certain hazardous substances in electrical and electronic equipment (RoHS2 Directive) and is deemed to comply with the maximum concentration values issued by the European Technical Adaptation Committee (TAC) as shown below:

Substance	Proposed Maximum Concentration	Actual Concentration
Lead (Pb)	0.1%	< 0.1%
Mercury (Hg)	0.1%	< 0.1%
Cadmium (Cd)	0.01%	< 0.01%
Hexavalent Chromium (Cr6 <sup>+</sup> )	0.1%	< 0.1%
Polybrominated biphenyls (PBB)	0.1%	< 0.1%
Polybrominated diphenyl ethers (PBDE)	0.1%	< 0.1%
Bis(2-Ethylhexyl) phthalate (DEHP)	0.1%	< 0.1%
Benzyl butyl phthalate (BBP)	0.1%	< 0.1%
Dibutyl phthalate (DBP)	0.1%	< 0.1%
Diisobutyl phthalate (DIBP)	0.1%	< 0.1%

**Certain components of products as stated above are exempted under the Annex III of the RoHS2 Directives as noted below. Examples of exempted components are:**

- Mercury in cold cathode fluorescent lamps and external electrode fluorescent lamps (CCFL and EEFL) for special purposes not exceeding (per lamp):
  - » Short length (500 mm): maximum 3.5 mg per lamp.
  - » Medium length (> 500 mm and 1,500 mm): maximum 5 mg per lamp.
  - » Long length (> 1,500 mm): maximum 13 mg per lamp.
- Lead in glass of cathode ray tubes.
- Lead in glass of fluorescent tubes not exceeding 0.2% by weight.
- Lead as an alloying element in aluminum containing up to 0.4% lead by weight.
- Copper alloy containing up to 4% lead by weight.
- Lead in high melting temperature type solders (i.e. lead-based alloys containing 85% by weight or more lead).
- Electrical and electronic components containing lead in a glass or ceramic other than dielectric ceramic in capacitors, e.g. piezoelectronic devices, or in a glass or ceramic matrix compound.

## **Indian Restriction of Hazardous Substances**

Restriction on Hazardous Substances statement (India). This product complies with the “India E-waste Rule 2011” and prohibits use of lead, mercury, hexavalent chromium, polybrominated biphenyls or polybrominated diphenyl ethers in concentrations exceeding 0.1 weight % and 0.01 weight % for cadmium, except for the exemptions set in Schedule 2 of the Rule.

## **Product Disposal at End of Product Life**

ViewSonic® respects the environment and is committed to working and living green. Thank you for being part of Smarter, Greener Computing. Please visit the ViewSonic® website to learn more.

### **USA & Canada:**

<https://www.viewsonic.com/us/go-green-with-viewsonic>

### **Europe:**

<https://www.viewsonic.com/eu/go-green-with-viewsonic>

### **Taiwan:**

<https://recycle.epa.gov.tw/>

## Copyright Information

Copyright© ViewSonic® Corporation, 2023. All rights reserved.

Macintosh and Power Macintosh are registered trademarks of Apple Inc.

Microsoft, Windows, and the Windows logo are registered trademarks of Microsoft Corporation in the United States and other countries.

ViewSonic®, the three birds logo, OnView, ViewMatch, and ViewMeter are registered trademarks of ViewSonic® Corporation.

VESA is a registered trademark of the Video Electronics Standards Association. DPMS, DisplayPort, and DDC are trademarks of VESA.

ENERGY STAR® is a registered trademark of the U.S. Environmental Protection Agency (EPA).

As an ENERGY STAR® partner, ViewSonic® Corporation has determined that this product meets the ENERGY STAR® guidelines for energy efficiency.

**Disclaimer:** ViewSonic® Corporation shall not be liable for technical or editorial errors or omissions contained herein; nor for incidental or consequential damages resulting from furnishing this material, or the performance or use of this product.

In the interest of continuing product improvement, ViewSonic® Corporation reserves the right to change product specifications without notice. Information in this document may change without notice.

No part of this document may be copied, reproduced, or transmitted by any means, for any purpose without prior written permission from ViewSonic® Corporation.

## Customer Service

For technical support or product service, see the table below or contact your reseller.

**NOTE:** You will need the product's serial number.

Country/ Region	Website	Country/ Region	Website
<b>Asia Pacific &amp; Africa</b>			
Australia	<a href="http://www.viewsonic.com/au/">www.viewsonic.com/au/</a>	Bangladesh	<a href="http://www.viewsonic.com/bd/">www.viewsonic.com/bd/</a>
中国 (China)	<a href="http://www.viewsonic.com.cn">www.viewsonic.com.cn</a>	香港 (繁體中文)	<a href="http://www.viewsonic.com/hk/">www.viewsonic.com/hk/</a>
Hong Kong (English)	<a href="http://www.viewsonic.com/hk-en/">www.viewsonic.com/hk-en/</a>	India	<a href="http://www.viewsonic.com/in/">www.viewsonic.com/in/</a>
Indonesia	<a href="http://www.viewsonic.com/id/">www.viewsonic.com/id/</a>	Israel	<a href="http://www.viewsonic.com/il/">www.viewsonic.com/il/</a>
日本 (Japan)	<a href="http://www.viewsonic.com/jp/">www.viewsonic.com/jp/</a>	Korea	<a href="http://www.viewsonic.com/kr/">www.viewsonic.com/kr/</a>
Malaysia	<a href="http://www.viewsonic.com/my/">www.viewsonic.com/my/</a>	Middle East	<a href="http://www.viewsonic.com/me/">www.viewsonic.com/me/</a>
Myanmar	<a href="http://www.viewsonic.com/mm/">www.viewsonic.com/mm/</a>	Nepal	<a href="http://www.viewsonic.com/np/">www.viewsonic.com/np/</a>
New Zealand	<a href="http://www.viewsonic.com/nz/">www.viewsonic.com/nz/</a>	Pakistan	<a href="http://www.viewsonic.com/pk/">www.viewsonic.com/pk/</a>
Philippines	<a href="http://www.viewsonic.com/ph/">www.viewsonic.com/ph/</a>	Singapore	<a href="http://www.viewsonic.com/sg/">www.viewsonic.com/sg/</a>
臺灣 (Taiwan)	<a href="http://www.viewsonic.com/tw/">www.viewsonic.com/tw/</a>	ประเทศไทย	<a href="http://www.viewsonic.com/th/">www.viewsonic.com/th/</a>
Việt Nam	<a href="http://www.viewsonic.com/vn/">www.viewsonic.com/vn/</a>	South Africa & Mauritius	<a href="http://www.viewsonic.com/za/">www.viewsonic.com/za/</a>
<b>Americas</b>			
United States	<a href="http://www.viewsonic.com/us">www.viewsonic.com/us</a>	Canada	<a href="http://www.viewsonic.com/us">www.viewsonic.com/us</a>
Latin America	<a href="http://www.viewsonic.com/la">www.viewsonic.com/la</a>		
<b>Europe</b>			
Europe	<a href="http://www.viewsonic.com/eu/">www.viewsonic.com/eu/</a>	France	<a href="http://www.viewsonic.com/fr/">www.viewsonic.com/fr/</a>
Deutschland	<a href="http://www.viewsonic.com/de/">www.viewsonic.com/de/</a>	Қазақстан	<a href="http://www.viewsonic.com/kz/">www.viewsonic.com/kz/</a>
Россия	<a href="http://www.viewsonic.com/ru/">www.viewsonic.com/ru/</a>	España	<a href="http://www.viewsonic.com/es/">www.viewsonic.com/es/</a>
Türkiye	<a href="http://www.viewsonic.com/tr/">www.viewsonic.com/tr/</a>	Україна	<a href="http://www.viewsonic.com/ua/">www.viewsonic.com/ua/</a>
United Kingdom	<a href="http://www.viewsonic.com/uk/">www.viewsonic.com/uk/</a>		

## **Limited Warranty**

### ViewSonic® Projector

#### **What the warranty covers:**

ViewSonic® warrants its products to be free from defects in material and workmanship, under normal use, during the warranty period. If a product proves to be defective in material or workmanship during the warranty period, ViewSonic® will, at its sole option, repair or replace the product with a like product. Replacement product or parts may include remanufactured or refurbished parts or components.

#### **Limited Three (3) year General Warranty:**

Subject to the more limited one (1) year warranty set out below, North and South America: Three (3) years warranty for all parts excluding the lamp, three (3) years for labor, and one (1) year for the original lamp from the date of the first consumer purchase.

Other regions or countries: Please check with your local dealer or local ViewSonic® office for the warranty information.

#### **Limited One (1) year Heavy Usage Warranty:**

Under heavy usage settings, where a projector's use includes more than fourteen (14) hours average daily usage, North and South America: One (1) year warranty for all parts excluding the lamp, one (1) year for labor, and ninety (90) days for the original lamp from the date of the first consumer purchase; Europe: One (1) year warranty for all parts excluding the lamp, one (1) year for labor, and ninety (90) days for the original lamp from the date of the first consumer purchase. Other regions or countries: Please check with your local dealer or local ViewSonic® office for the warranty information. Lamp warranty subject to terms and conditions, verification and approval. Applies to manufacturer's installed lamp only. All accessory lamps purchased separately are warranted for 90 days.

#### **Who the warranty protects:**

This warranty is valid only for the first consumer purchaser.

#### **What the warranty does not cover:**

1. Any product on which the serial number has been defaced, modified, or removed.
2. Damage, deterioration, or malfunction resulting from:



- » Accident, misuse, neglect, fire, water, lightning, or other acts of nature, unauthorized product modification, or failure to follow instructions supplied with the product.
- » Operation outside of product specifications.
- » Operation of the product for other than the normal intended use or not under normal conditions.
- » Repair or attempted repair by anyone not authorized by ViewSonic®.
- » Any damage of the product due to shipment.
- » Removal or installation of the product.
- » Causes external to the product, such as electric power fluctuations or failure.
- » Use of supplies or parts not meeting Viewsonic's specifications.
- » Normal wear and tear.
- » Any other cause which does not relate to a product defect.

### 3. Removal, installation, and set-up service charges.

#### **How to get service:**

1. For information about receiving service under warranty, contact ViewSonic® Customer Support (Please refer to the "Customer Support" page). You will need to provide your product's serial number.
2. To obtain warranted service, you will be required to provide: (a) the original dated sales slip, (b) your name, (c) your address, (d) a description of the problem, and (e) the serial number of the product.
3. Take or ship the product, freight prepaid, in the original container to an authorized ViewSonic® service center or ViewSonic®.
4. For additional information or the name of the nearest ViewSonic® service center, contact ViewSonic®.

#### **Limitation of implied warranties:**

There are no warranties, express or implied, which extend beyond the description contained herein including the implied warranty of merchantability and fitness for a particular purpose.

**Exclusion of damages:**

ViewSonic's liability is limited to the cost of repair or replacement of the product. ViewSonic® shall not be liable for:

1. Damage to other property caused by any defects in the product, damages based upon inconvenience, loss of use of the product, loss of time, loss of profits, loss of business opportunity, loss of goodwill, interference with business relationships, or other commercial loss, even if advised of the possibility of such damages.
2. Any other damages, whether incidental, consequential or otherwise.
3. Any claim against the customer by any other party.

**Effect of state law:**

This warranty gives you specific legal rights, and you may also have other rights which vary from local authority. Some local governments do not allow limitations on implied warranties and/or do not allow the exclusion of incidental or consequential damages, so the above limitations and exclusions may not apply to you.

**Sales outside the U.S.A. and Canada:**

For warranty information and service on ViewSonic® products sold outside of the U.S.A. and Canada, contact ViewSonic® or your local ViewSonic® dealer.

The warranty period for this product in mainland China (Hong Kong, Macao, and Taiwan Excluded) is subject to the terms and conditions of the Maintenance Guarantee Card.

For users in Europe and Russia, full details of warranty provided can be found at: <http://www.viewsonic.com/eu/> under "Support/Warranty Information".

# Mexico Limited Warranty

## ViewSonic® Projector

### What the warranty covers:

ViewSonic® warrants its products to be free from defects in material and workmanship, under normal use, during the warranty period. If a product proves to be defective in material or workmanship during the warranty period, ViewSonic® will, at its sole option, repair or replace the product with a like product. Replacement product or parts may include remanufactured or refurbished parts or components & accessories.

### How long the warranty is effective:

3 years for all parts excluding the lamp, 3 years for labor, 1 year for the original lamp from the date of the first consumer purchase.

Lamp warranty subject to terms and conditions, verification and approval. Applies to manufacturer's installed lamp only.

All accessory lamps purchased separately are warranted for 90 days.

### Who the warranty protects:

This warranty is valid only for the first consumer purchaser.

### What the warranty excludes and does not cover:

1. Any product on which the serial number has been defaced, modified or removed.
2. Damage, deterioration, or malfunction resulting from:
  - » Accident, misuse, neglect, fire, water, lightning, or other acts of nature, unauthorized product modification, unauthorized attempted repair, or failure to follow instructions supplied with the product.
  - » Any damage of the product due to shipment.
  - » Causes external to the product, such as electrical power fluctuations or failure.
  - » Use of supplies or parts not meeting ViewSonic®'s specifications.
  - » Normal wear and tear.
  - » Any other cause which does not relate to a product defect.
3. Any product exhibiting a condition commonly known as "image burn-in" which results when a static image is displayed on the product for an extended period of time.
4. Removal, installation, insurance, and set-up service charges.

**How to get service:**

For information about receiving service under warranty, contact ViewSonic® Customer Support (Please refer to the attached “Customer Service” page). You will need to provide your product’s serial number, so please record the product information in the space provided below on your purchase for your future use. Please retain your receipt of proof of purchase to support your warranty claim.

**For Your Records**

Product Name: \_\_\_\_\_ Model Number: \_\_\_\_\_

Document Number: \_\_\_\_\_ Serial Number: \_\_\_\_\_

Purchase Date: \_\_\_\_\_ Extended Warranty Purchase? \_\_\_\_\_ (Y/N)

If so, what date does warranty expire? \_\_\_\_\_

1. To obtain warranty service, you will be required to provide (a) the original dated sales slip, (b) your name, (c) your address, (d) a description of the problem, and (e) the serial number of the product.
2. Take or ship the product, in the original container packaging, to an authorized ViewSonic® service center.
3. Round trip transportation costs for in-warranty products will be paid by ViewSonic®.

**Limitation of implied warranties:**

There are no warranties, express or implied, which extend beyond the description contained herein including the implied warranty of merchantability and fitness for a particular purpose.

**Exclusion of damages:**

ViewSonic®’s liability is limited to the cost of repair or replacement of the product. ViewSonic® shall not be liable for:

1. Damage to other property caused by any defects in the product, damages based upon inconvenience, loss of use of the product, loss of time, loss of profits, loss of business opportunity, loss of goodwill, interference with business relationships, or other commercial loss, even if advised of the possibility of such damages.
2. Any other damages, whether incidental, consequential or otherwise.
3. Any claim against the customer by any other party.
4. Repair or attempted repair by anyone not authorized by ViewSonic®.

Contact Information for Sales & Authorized Service (Centro Autorizado de Servicio) within Mexico:	
<b>Name, address, of manufacturer and importers:</b> México, Av. de la Palma #8 Piso 2 Despacho 203, Corporativo Interpalmas, Col. San Fernando Huixquilucan, Estado de México Tel: (55) 3605-1099 <a href="http://www.viewsonic.com/la/soporte/index.htm">http://www.viewsonic.com/la/soporte/index.htm</a>	
NÚMERO GRATIS DE ASISTENCIA TÉCNICA PARA TODO MÉXICO: 001.866.823.2004	
<b>Hermosillo:</b> Distribuciones y Servicios Computacionales SA de CV. Calle Juárez 284 local 2 Col. Bugambilias C.P: 83140 Tel: 01-66-22-14-9005 E-Mail: <a href="mailto:disc2@hmo.megared.net.mx">disc2@hmo.megared.net.mx</a>	<b>Villahermosa:</b> Compumantenimientos Garantizados, S.A. de C.V. AV. GREGORIO MENDEZ #1504 COL, FLORIDA C.P. 86040 Tel: 01 (993) 3 52 00 47 / 3522074 / 3 52 20 09 E-Mail: <a href="mailto:compumantenimientos@prodigy.net.mx">compumantenimientos@prodigy.net.mx</a>
<b>Puebla, Pue. (Matriz):</b> RENTA Y DATOS, S.A. DE C.V. Domicilio: 29 SUR 721 COL. LA PAZ 72160 PUEBLA, PUE. Tel: 01(52).222.891.55.77 CON 10 LINEAS E-Mail: <a href="mailto:datos@puebla.megared.net.mx">datos@puebla.megared.net.mx</a>	<b>Veracruz, Ver.:</b> CONEXION Y DESARROLLO, S.A DE C.V. Av. Americas # 419 ENTRE PINZÓN Y ALVARADO Fracc. Reforma C.P. 91919 Tel: 01-22-91-00-31-67 E-Mail: <a href="mailto:gacosta@qplus.com.mx">gacosta@qplus.com.mx</a>
<b>Chihuahua:</b> Soluciones Globales en Computación C. Magisterio # 3321 Col. Magisterial Chihuahua, Chih. Tel: 4136954 E-Mail: <a href="mailto:Cefeo@soluglobales.com">Cefeo@soluglobales.com</a>	<b>Cuernavaca:</b> Compusupport de Cuernavaca SA de CV Francisco Leyva # 178 Col. Miguel Hidalgo C.P. 62040, Cuernavaca Morelos Tel: 01 777 3180579 / 01 777 3124014 E-Mail: <a href="mailto:aquevedo@compusupportcva.com">aquevedo@compusupportcva.com</a>
<b>Distrito Federal:</b> QPLUS, S.A. de C.V. Av. Coyoacán 931 Col. Del Valle 03100, México, D.F. Tel: 01(52)55-50-00-27-35 E-Mail : <a href="mailto:gacosta@qplus.com.mx">gacosta@qplus.com.mx</a>	<b>Guadalajara, Jal.:</b> SERVICRECE, S.A. de C.V. Av. Niños Héroes # 2281 Col. Arcos Sur, Sector Juárez 44170, Guadalajara, Jalisco Tel: 01(52)33-36-15-15-43 E-Mail: <a href="mailto:mmiranda@servicrece.com">mmiranda@servicrece.com</a>
<b>Guerrero Acapulco:</b> GS Computación (Grupo Sesicomp) Progreso #6-A, Colo Centro 39300 Acapulco, Guerrero Tel: 744-48-32627	<b>Monterrey:</b> Global Product Services Mar Caribe # 1987, Esquina con Golfo Pérsico Fracc. Bernardo Reyes, CP 64280 Monterrey N.L. México Tel: 8129-5103 E-Mail: <a href="mailto:aydeem@gps1.com.mx">aydeem@gps1.com.mx</a>
<b>MERIDA:</b> ELECTROSER Av Reforma No. 403Gx39 y 41 Mérida, Yucatán, México CP97000 Tel: (52) 999-925-1916 E-Mail: <a href="mailto:rrrb@sureste.com">rrrb@sureste.com</a>	<b>Oaxaca, Oax.:</b> CENTRO DE DISTRIBUCION Y SERVICIO, S.A. de C.V. Murguía # 708 P.A., Col. Centro, 68000, Oaxaca Tel: 01(52)95-15-15-22-22 Fax: 01(52)95-15-13-67-00 E-Mail: <a href="mailto:gpotai2001@hotmail.com">gpotai2001@hotmail.com</a>
<b>Tijuana:</b> STD Av Ferrocarril Sonora #3780 L-C Col 20 de Noviembre Tijuana, Mexico	<b>FOR USA SUPPORT:</b> ViewSonic® Corporation 381 Brea Canyon Road, Walnut, CA. 91789 USA Tel: 800-688-6688 E-Mail: <a href="http://www.viewsonic.com">http://www.viewsonic.com</a>



**ViewSonic®**  
*See the difference®*