

The BenQ logo is displayed in a white, rounded, speech-bubble-like shape. The text "BenQ" is written in a bold, purple, sans-serif font.

Digital Projector

# User Manual

LU9750/LU9800

VI.00

# Copyright and disclaimer

## Copyright

Copyright 2021 BenQ Corporation. All rights reserved. No part of this publication may be reproduced, transmitted, transcribed, stored in a retrieval system or translated into any language or computer language, in any form or by any means, electronic, mechanical, magnetic, optical, chemical, manual or otherwise, without the prior written permission of BenQ Corporation. All other logos, products, or company names mentioned in this manual may be the registered trademarks or copyrights of their respective companies, and are used for informational purposes only.

## Disclaimer

BenQ Corporation makes no representations or warranties, either expressed or implied, with respect to the contents hereof and specifically disclaims any warranties, merchantability or fitness for any particular purpose. Further, BenQ Corporation reserves the right to revise this publication and to make changes from time to time in the contents hereof without obligation of BenQ Corporation to notify any person of such revision or changes.

This user manual aims to provide the most updated and accurate information to customers, and thus all contents may be modified from time to time without prior notice. Please visit <http://www.benq.com> for the latest version of this manual.

## Statement regarding hyperlinks and third-party websites

BenQ is not responsible for the content of the websites or of similar resources, which are maintained and controlled by third parties, that may be linked from this product. Providing links to those websites or to similar resources does not mean that BenQ makes any warranty or representation to their content by expression or by implication.

Any third party content or service preinstalled in this product is provided "as is". BenQ does not, by expression or by implication, make any warrant to the content or to the services provided by third parties. BenQ does not warrant or guarantee that the content or services provided by third parties are accurate, effective, most up-to-date, legal, or complete. Under no circumstances shall BenQ be liable for the content or services provided by third parties including their negligence. Services provided by third parties may be terminated temporarily or permanently. BenQ does not warrant or guarantee that the any content or services provided by third parties are in good condition at any time, and is not liable for the termination of the said content and services. In addition, BenQ is not involved in any transactions you conduct in the websites or similar resources maintained by third parties.

You should contact the content or service providers for any questions, concerns, or disputes.

# Table of Contents

<b>Copyright and disclaimer .....</b>	<b>2</b>
Copyright.....	2
Disclaimer.....	2
Statement regarding hyperlinks and third-party websites .....	2
<b>Important safety instructions.....</b>	<b>6</b>
<b>General safety instruction .....</b>	<b>6</b>
<b>Notice on laser.....</b>	<b>7</b>
Laser class.....	7
Laser parameters .....	7
<b>Risk Group 3 Information .....</b>	<b>8</b>
Light hazard warning.....	8
Label instruction .....	8
Laser light instruction .....	10
<b>Prepare for installation .....</b>	<b>11</b>
Caution for installation.....	11
Cooling notice .....	12
<b>Package contents .....</b>	<b>14</b>
<b>Standard packing items .....</b>	<b>14</b>
<b>Lens information.....</b>	<b>14</b>
<b>Introduction.....</b>	<b>15</b>
<b>Projector exterior view.....</b>	<b>15</b>
Front and upper side view .....	15
Rear and upper side view.....	15
<b>Controls and functions.....</b>	<b>16</b>
Control panel.....	16
Control terminal .....	17
Remote control.....	18
<b>Installation .....</b>	<b>21</b>
<b>Installing removing the optional lens .....</b>	<b>21</b>
Installing the new lens.....	21
Removing the existing lens from the projector .....	22
<b>Evaluate for distance by image size.....</b>	<b>23</b>
Obtaining a preferred projected image size .....	23
Projection dimensions.....	23
Lens dimension .....	26
<b>Adjusting by Lens shift .....</b>	<b>28</b>
Adjusting the vertical image position .....	28
Adjusting the horizontal image position.....	28
<b>Lens shift range diagram .....</b>	<b>28</b>

<b>Connection .....</b>	<b>29</b>
Before connecting.....	29
Connecting with AV equipment .....	31
Connecting with computer .....	31
Connecting with HDBaseT transmitter .....	32
Connecting with LAN.....	32
<b>Operations.....</b>	<b>33</b>
<b>Switch on/off the projector.....</b>	<b>33</b>
Connecting the power cord.....	33
Power indicator .....	33
Switch on the projector .....	34
Switch off the projector .....	40
<b>Using the menu .....</b>	<b>41</b>
<b>Main menu.....</b>	<b>41</b>
<b>Display menu.....</b>	<b>42</b>
Corner Fit menu .....	44
Digital Image Resizing.....	44
Blanking menu.....	45
Native Resolution .....	45
3D menu .....	46
Fast Mode .....	46
<b>Picture menu.....</b>	<b>47</b>
Color Temperature Fine Tuning menu .....	49
3D Color Management menu .....	50
<b>Source menu .....</b>	<b>51</b>
<b>System Setup : Basic menu .....</b>	<b>53</b>
Menu Settings menu.....	54
Operation Settings menu.....	54
Lens Settings menu.....	55
<b>System Setup : Advanced menu .....</b>	<b>57</b>
Audio Settings menu .....	59
Light Settings menu .....	60
Security Settings menu .....	60
Standby Settings menu.....	61
Network Settings menu .....	61
<b>Information menu.....</b>	<b>62</b>
<b>Menu structure .....</b>	<b>63</b>
<b>Maintenance .....</b>	<b>68</b>
<b>Before maintaining the projector .....</b>	<b>68</b>
Care of the projector .....	68
<b>Clean the lens front surface .....</b>	<b>68</b>
<b>Clean the projector case.....</b>	<b>68</b>
<b>LED indicator .....</b>	<b>69</b>
System message.....	69

<b>Troubleshooting .....</b>	<b>71</b>
<b>Troubleshooting.....</b>	<b>71</b>
The projector does not turn on.....	71
No picture.....	71
Blurred image.....	71
Remote control does not work.....	71
The password is incorrect.....	71
<b>Specifications.....</b>	<b>72</b>
<b>Specifications .....</b>	<b>72</b>
<b>Specifications .....</b>	<b>73</b>
<b>Dimensions .....</b>	<b>74</b>
<b>Appendix.....</b>	<b>75</b>
<b>Timing table .....</b>	<b>75</b>
HDMI Input (Support Video Timings).....	75
HDMI Input (Support PC Timings).....	75
PC Input(Support PC Timings) .....	76
True 3D Video Compatibility table .....	78
<b>RS232 command control .....</b>	<b>79</b>
<b>PJLink .....</b>	<b>87</b>
PJLink protocol .....	87
Control commands.....	87

# Important safety instructions

Your projector is designed and tested to meet the latest standards for safety of information technology equipment. However, to ensure safe use of this product, it is important that you follow the instructions mentioned in this manual and marked on the product.

## General safety instruction

1. Do not look straight at the projector lens during operation. The intense light beam may damage your eyes.
2. Always open the lens shutter or remove the lens cap when the projector light source is on.
3. In some countries, the line voltage is NOT stable. This projector is designed to operate safely within a mains voltage between 100 to 240 volts AC, but could fail if power cuts or surges of  $\pm 10$  volts occur. In areas where the mains voltage may fluctuate or cut out, it is recommended that you connect your projector through a power stabilizer, surge protector or uninterruptible power supply (UPS).
4. Do not block the projection lens with any objects when the projector is under operation as this could cause the objects to become heated and deformed or even cause a fire. To temporarily turn off the light source, press **BLANK** on the remote control.
5. Do not place this product on an unstable cart, stand, or table. The product may fall, sustaining serious damage.
6. Do not attempt to disassemble this projector. There are dangerous high voltages inside which may cause death if you should come into contact with live parts.  
Under no circumstances should you ever undo or remove any other covers. Refer servicing only to suitably qualified professional service personnel.
7. Do not place this projector in any of the following environments.
  - Space that is poorly ventilated or confined. Allow at least 50 cm clearance from walls and free flow of air around the projector.
  - Locations where temperatures may become excessively high, such as the inside of a car with all windows rolled up.
  - Locations where excessive humidity, dust, or cigarette smoke may contaminate optical components, shortening the projector's life span and darkening the image.
  - Locations near fire alarms
  - Locations with an ambient temperature above 40°C / 104°F
  - Locations where the altitudes are higher than 3000 m (10000 feet).
8. Do not block the ventilation holes.
  - Do not place this projector on a blanket, bedding or any other soft surface.
  - Do not cover this projector with a cloth or any other item.
  - Do not place inflammables near the projector.

If the ventilation holes are seriously obstructed, overheating inside the projector may result in a fire.

9. Do not step on the projector or place any objects upon it. Besides probable physical damage to the projector, doing so may result in accidents and possible injury.
10. Do not place liquids near or on the projector. Liquids spilled into the projector may cause it to fail. If the projector does become wet, disconnect it from the power supply's wall socket and call BenQ to have the projector serviced.



This equipment has a three-pin grounding-type power plug. Do not remove the grounding pin. As a safety feature, this plug will only fit a grounding-type power outlet. If you are unable to fit the plug into the outlet, contact an electrician.

## Notice on laser



This symbol indicates that there is a potential hazard of eye exposure to laser radiation unless the instructions are closely followed.

### Laser class



(for USA) This Laser Product is designated as Class 3R during all procedures of operation and complies with IEC/EN 60825-1:2007.

(for WW) This Laser Product is designated as Class I during all procedures of operation and complies with IEC/EN 60825-1:2014.

**LASER LIGHT - AVOID DIRECT EYE EXPOSURE.**



Do not point laser or allow laser light to be directed or reflected toward other people or reflective objects.

Direct or scattered light can be hazardous to eyes and skin.

There is a potential hazard of eye exposure to laser radiation if the included instructions are not followed.

Caution – use of controls or adjustments or performance of procedures other than those specified herein may result in hazardous radiation exposure.

### Laser parameters

Wavelength	449nm - 461nm (Blue)
Mode of operation	Pulsed, due to frame rate
Pulse width	1.34ms
Pulse repetition rate	120Hz
Maximum laser energy	0.698mj
Total internal power	>100w
Apparent source size	>10mm, at lens stop
Divergence	>100 mili Radian

## Risk Group 3 Information

### Light hazard warning



Failure to comply with the following may result in serious injury:

- No direct exposure to the beam is permitted, RG3 IEC 62471-5:2015.
- Operators control access to the beam within the hazard distance or install the projector at sufficient height to prevent exposures of spectators' eyes within the hazard distance.

The hazard distance is the distance measured from the projection lens at which the intensity or energy per unit of surface is lower than the applicable exposure limit on the cornea or skin. If the person is within the hazard distance, the beam is considered unsafe for exposure.

**The hazard distance for this projector is 0-150 cm.**

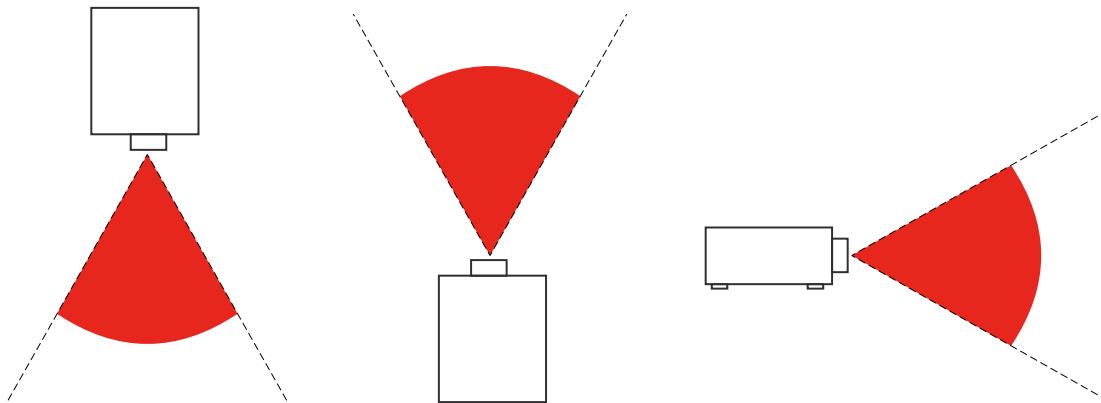

#### Note

This projector is an RG3 product, which must be installed in a safe place and must be handled by qualified and professionally skill trained personnel

For the installation and removal of the lens, please consult your dealer with qualified profession-als to install it. Do not try to install the projector yourself, otherwise your eyesight may be dam-aged

In case to install the projector over head, keep over 3m distance at least between the floor surface and the RG3 area. Operators shall control access to the beam within the hazard distance or install the product at the height that will prevent exposures of spectators' eyes within the hazard distance.

#### Caution:

Use of controls, adjustments or performance of procedures other than those specified herein may result in hazardous laser light exposure.



## Label instruction

Below drawing show the label's location.

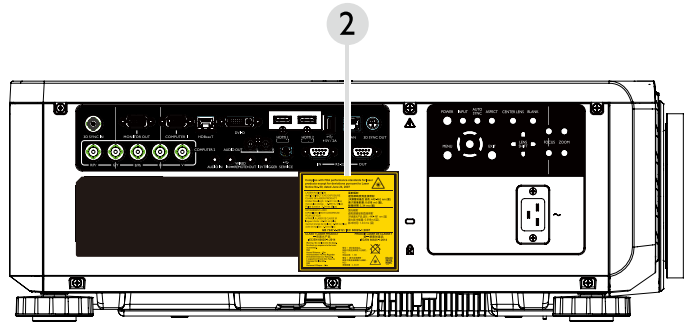
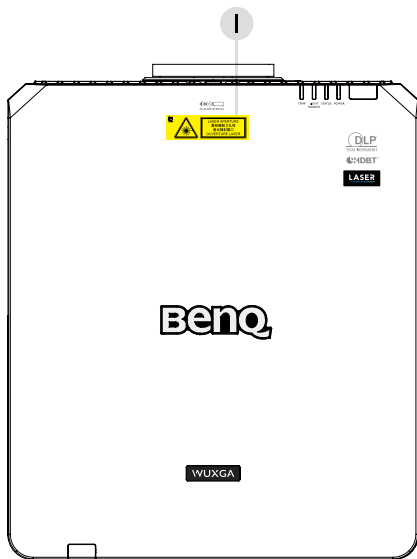

1. Laser warning label



2. Spec label



## Laser light instruction

Below drawing is the laser aperture location. Be careful not to let the eye see the light directly.

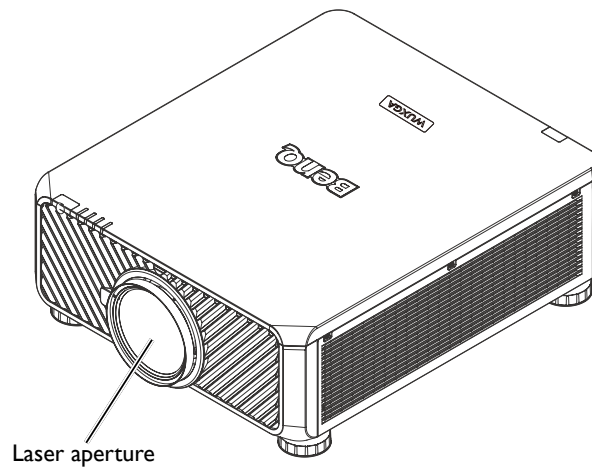

## Interlock switches

This machine has 2 (Top cover x 1, Lens x 1) Interlock switches to protect the laser light Leakage.

1. Will power-off the system individually when the top cover is removed.
2. Will power-off the system individually when the lens is removed or not install correctly.

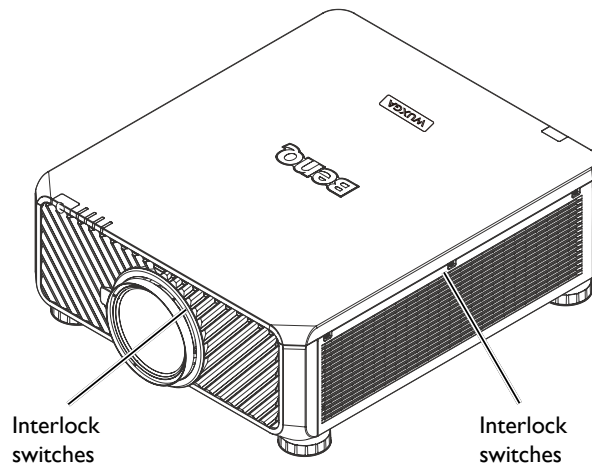

## Prepare for installation

### Caution for installation

1. If the projector and lens were purchased separately, remove the anti-dust cap before use and store it for future use. When transporting the projector, move the lens to the home position, remove the lens, and attach the anti-dust cap.

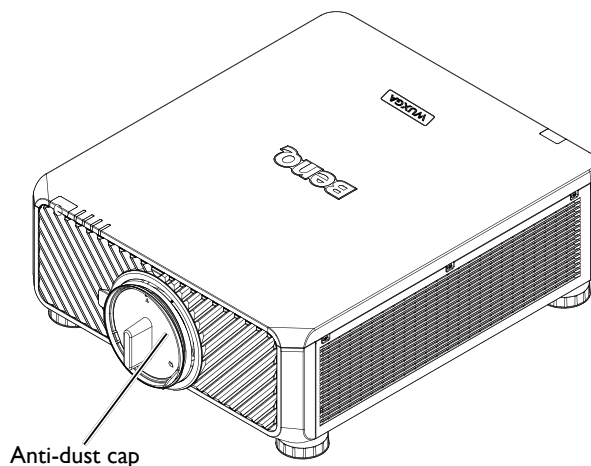

2. When the projector is not in use, attach the lens cover supplied with the projector or the projection lens.

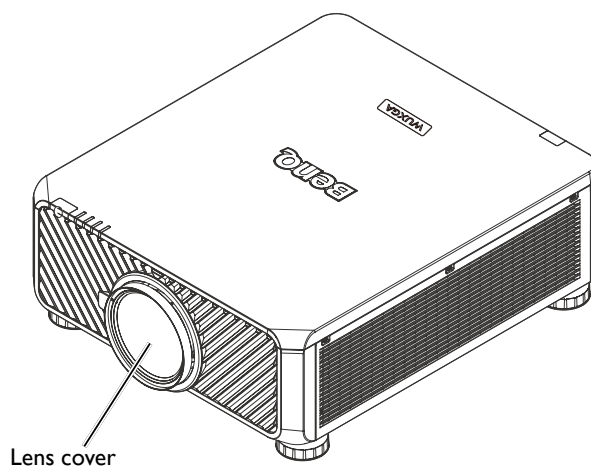

### Focus adjustment

The high clarity projection lens is thermally affected by the light from the bulb; thus, the focus is unstable for a short period immediately after the power is turned on. Please wait at least 15 minutes of continuous projection before adjusting the focus.

## Cooling notice

Allow at least 50 cm (19.7 inch) for clearance around the exhaust vent. Make sure no objects block air input within 30 cm (11.8 inch).

Keep the outlet at least 1 m away from the inlets of other projectors.

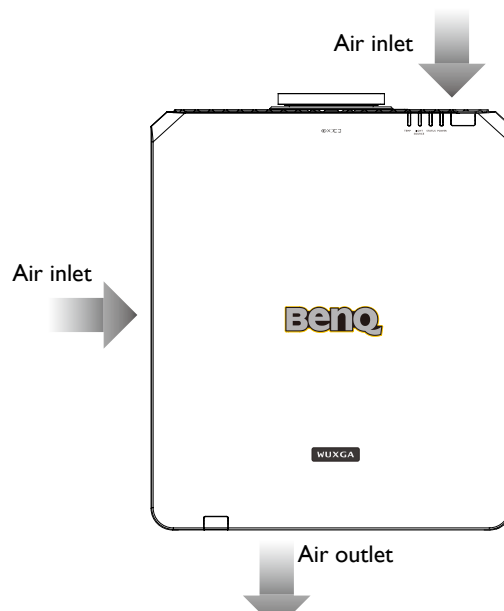

- The projector can be installed at any angle.

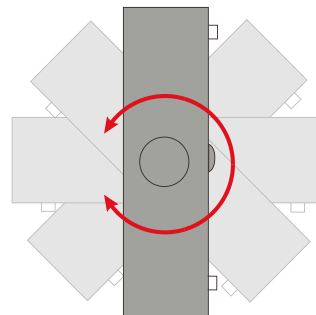
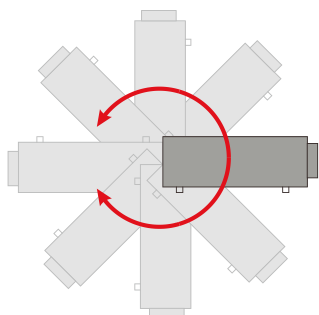

- Allow at least 50 cm of clearance around the exhaust vent.

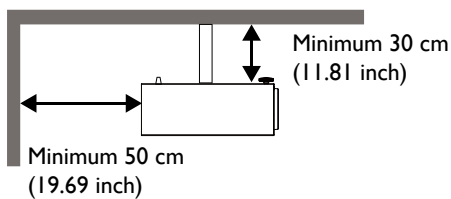
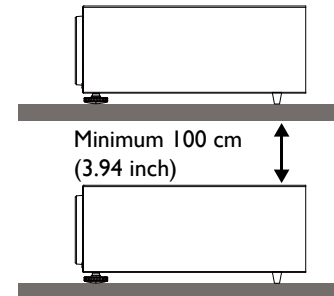
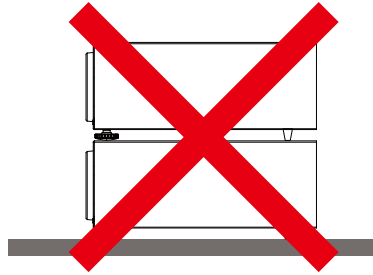
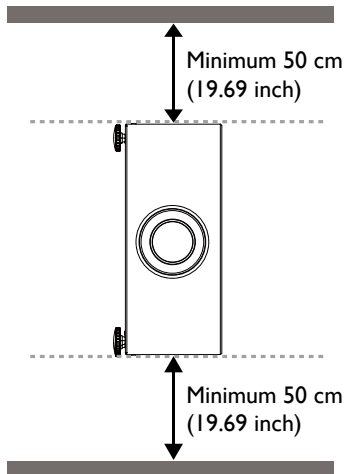
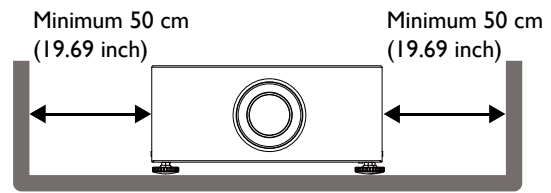
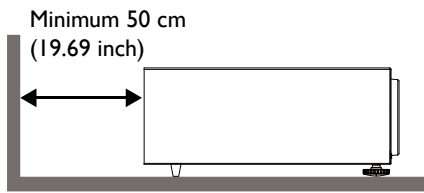

- Ensure that the air intake vents do not recycle hot air from the exhaust vent.
- When operating in an enclosed space, make sure that the surrounding air temperature does not exceed the projector's operating temperature and that the air intake and exhaust vents are unobstructed.
- All enclosures should pass a certified thermal evaluation to ensure that the projector does not recycle exhaust air. Recycling exhaust air may cause the projector to shutdown even if the ambient temperature is within the acceptable operating temperature range.

## Package contents

### Standard packing items

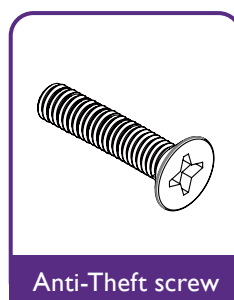
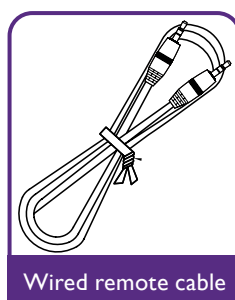
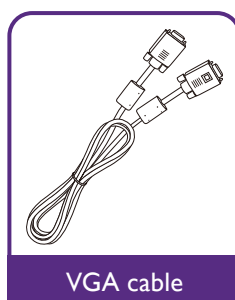
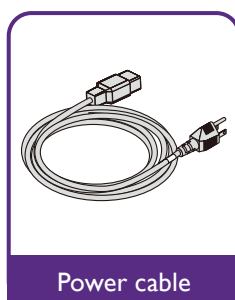
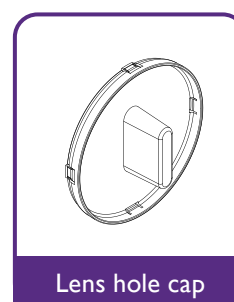
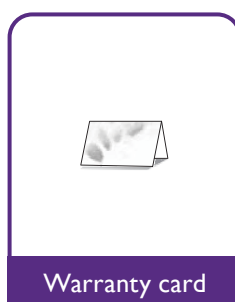
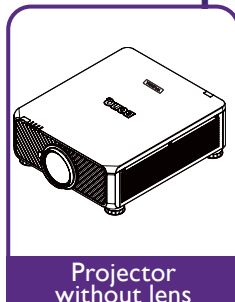

### Lens information

Model	Lens Type	Part Number	Throw Ratio	Lens Shift
LSIST3A	Short throw	5J.JPN37.001	WUXGA: 0.77-1.1	Vertical: -15%-55% Horizontal: -5%-5%
LSIST2A	Wide zoom 2	5J.JPN37.002	WUXGA: 1.1-1.3	Vertical: -15%-55% Horizontal: -5%-5%
LSIST1A	Wide zoom 1	5J.JPN37.003	WUXGA: 1.25-1.6	Vertical: -15%-55% Horizontal: -5%-5%
LSISDA	Standard	5J.JPN37.004	WUXGA: 1.54-1.93	Vertical: -15%-55% Horizontal: -5%-5%
LSILT0	Semi long	5J.JPN37.005	WUXGA: 1.93-2.9	Vertical: -15%-55% Horizontal: -5%-5%
LSILT1	Semi Long 2	5J.JAM37.051	WUXGA: 2.22-3.67	Vertical: -15%-55% Horizontal: -5%-5%
LSILT2	Long Zoom 1	5J.JAM37.031	WUXGA: 3.58-5.38	Vertical: -15%-55% Horizontal: -5%-5%
LSILT3	Long Zoom 2	5J.JAM37.041	WUXGA: 5.31~8.26	Vertical: -15%-55% Horizontal: -5%-5%
LSIST4	Ultra Short throw	5J.JCY37.001	WUXGA: 0.377	Vertical: -0%-0% Horizontal: -0%-0%

# Introduction

## Projector exterior view

### Front and upper side view

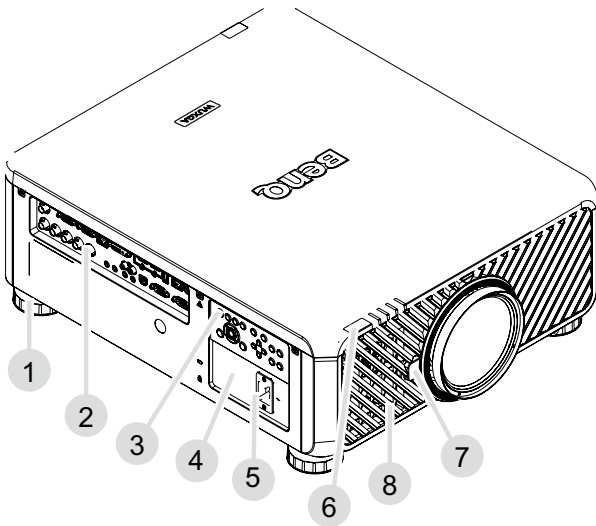

1. Foot for adjusting projector level
2. IO panel
3. Control panel
4. Slide switch (voltage selection)
5. AC power switch
6. Front IR sensor
7. Lens release button
8. Air intake

### Rear and upper side view

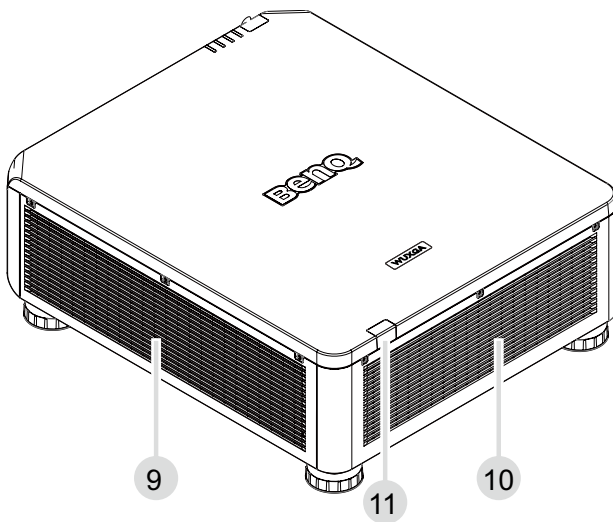

9. Air intake
10. Air exhaust
11. Rear IR sensor

## Controls and functions

### Control panel

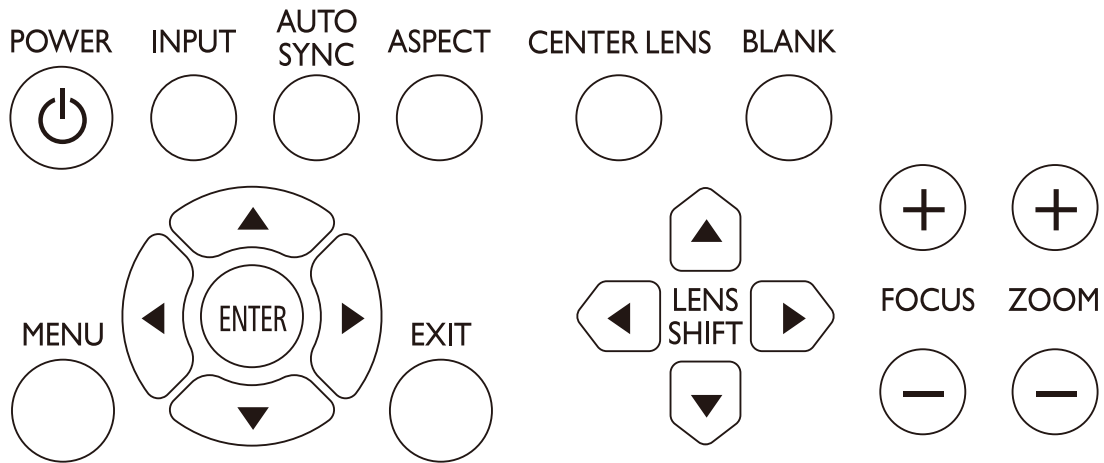

- **POWER**  
Press to power on/off your projector.
- **INPUT**  
Press to select video sources including HDMI, DVI-D, Computer 1, Computer 2, DisplayPort and HDBaseT.
- **AUTO SYNC**  
Press to execute auto signal sync.
- **ASPECT**  
Press to switch aspect ratio of current image.
- **MENU**  
Press to display OSD menu or return to the upper menu level.
- **ENTER**  
Press to select, accept or change settings.
- **EXIT**  
Press to exit OSD menu.
- **CENTER LENS**  
Press to center the lens and reset its shift, focus and zoom parameters.

#### Note

The lens memory requires precise lens parameter adjustments. Please re-run the Center Lens function once you install the lens.

- **BLANK**  
Press the button to temporarily interrupt the projection.
- **LENS SHIFT**  
Press to move lens up, down, left and right.
- **FOCUS**  
Press to adjust focus of projection image.
- **ZOOM**  
Press to zoom in and out on projection image. Remote control and functions.



## Control terminal

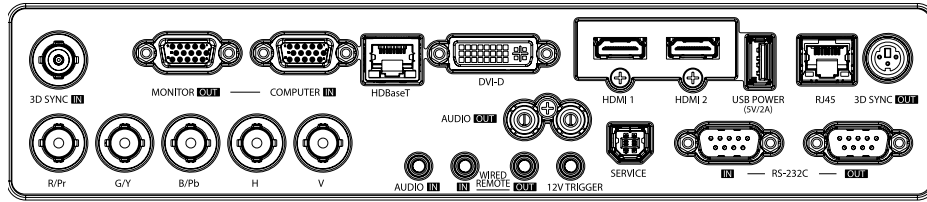

- **3D SYNC IN**  
Connect 3D-sync in cable from a computer or an enabled device.
- **MONITOR OUT**  
Connection to other display equipment for concurrent playback display.
- **COMPUTER IN**  
15-pin VGA port for connection to RGB, component HD source, or PC.
- **HDBaseT**  
Connect an Ethernet cable (Cat5/Cat6) from HDBaseT transmitter with high-definition video (HD), RS232 control and LAN control.
- **DVI-D**  
Connection to DVI source.
- **HDMI 1**  
Connection to HDMI source.
- **HDMI 2**  
Connection to HDMI source.
- **USB POWER 2A**  
Support 5V/2A output.
- **RJ45**  
For connection to RJ45 Cat5/Cat6 Ethernet cable to control the projector through a network.
- **3D SYNC OUT**  
Connection to 3D IR sync signal transmitter.
- **RS-232 IN**  
Standard 9-pin D-sub interface for connection to PC control system and projector maintenance.
- **RS-232 OUT**  
Connects to another projector (same model) for RS-232 control.
- **SERVICE**  
Maintenance exclusive port for authorized maintenance personnel only.
- **AUDIO OUT (L/R)**  
Connection to a speaker or headset.
- **12V TRIGGER**  
3.5mm mini earphone jack, employs 200mA display relay to provide 12(+/-1.5)V output and short circuit protection.
- **WIRED REMOTE IN**  
Connection to remote control for wire remote control.
- **WIRED REMOTE OUT**  
Connection to another projector.
- **AUDIO IN**  
Connection to an audio input source via an audio cable.
- **R/Pr, G/Y, B/Pb, H, V**  
Connection to RGB or YPbPr/YCbCr output signal with BNC type input terminal.

### **Caution:**

Make sure the port is valid before inserting a wired remote controller. The remote controller may be damaged in case of an invalid port, e.g. a wired remote controller is connected to trigger output. For more information about upgrading firmware via Lan, please contact BenQ service.

## Remote control

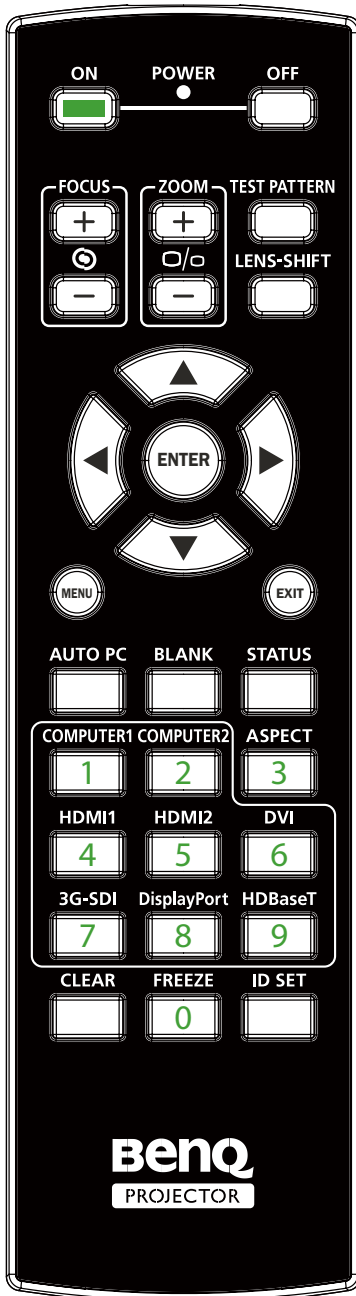

- **ON**  
Press to power on projector.
- **OFF**  
Press to power off projector.
- **FOCUS +/-**  
Press to adjust focus of projection image.
- **ZOOM +/-**  
Press to zoom in and out on projection image.
- **TEST PATTERN**  
Press to display embedded test pattern. Press continuously to scroll through available ones. Press MENU key to exit to projection image.
- **LENS SHIFT**  
Press to move lens up, down, left and right.
- **ENTER**  
Press to select or accept settings.
- **MENU**  
Press to display OSD menu or return to the upper menu level.
- **EXIT**  
Press to exit OSD menu.
- **AUTO PC**  
Press to execute auto signal sync.
- **BLANK**  
Press the button to temporarily interrupt the projection.
- **STATUS**  
Show OSD MENU – Information.
- **COMPUTER 1**  
Select COMPUTER 1 input source.
- **COMPUTER 2**  
Select COMPUTER 2 input source.
- **ASPECT**  
Press continuously to scroll through individual aspect ratio.
- **HDMI 1**  
Select HDMI 1 input source.
- **HDMI 2**  
Function same as HDMI 1.
- **DVI**  
Select DVI input source.
- **3G-SDI**  
Select 3G-SDI input source.
- **DisplayPort**  
Select DisplayPort input source.
- **HDBaseT**  
Select HDBaseT input source.
- **CLEAR**  
Not available with this model.
- **FREEZE**  
Press to toggle switch between freeze and unfreeze.
- **ID SET:**  
Not available for this model.

## Connect with projector

When you use a system with multiple projectors, use commercially available M3 stereo mini jack cables to connect the other projectors via the WIRED REMOTE IN/WIRED REMOTE OUT terminals.

The remote control is effective even in places where obstacles stand in the light path or where devices are susceptible to outside light.

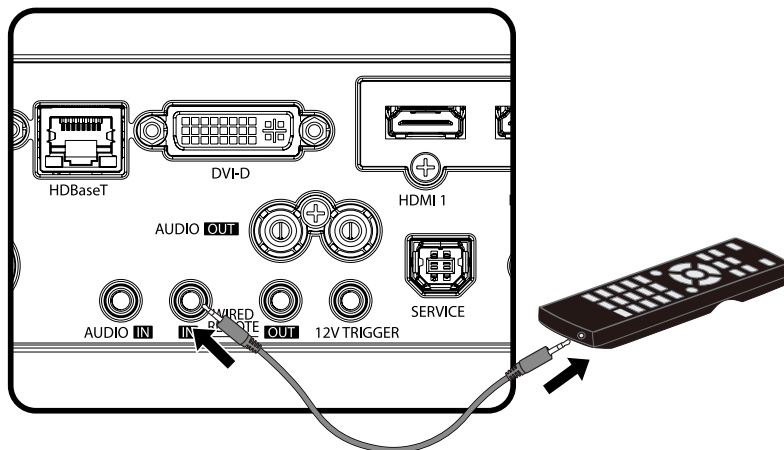

### Note:

Use two core shielded cables no longer than 15 m (49.2 ft). The remote control may not operate when the length of the cable exceeds 15 m (49.2 ft) or when it is not properly shielded.

## Remote control effective range

Infra-Red (IR) remote control sensor is located on the front and rear of the projector. The remote control must be held at an angle within 30 degrees perpendicular to the projector's IR remote control sensor to function correctly. The distance between the remote control and the sensor should not exceed 8 meters (~ 26 feet).

Make sure that there are no obstacles between the remote control and the IR sensor on the projector that might obstruct the infra-red beam.

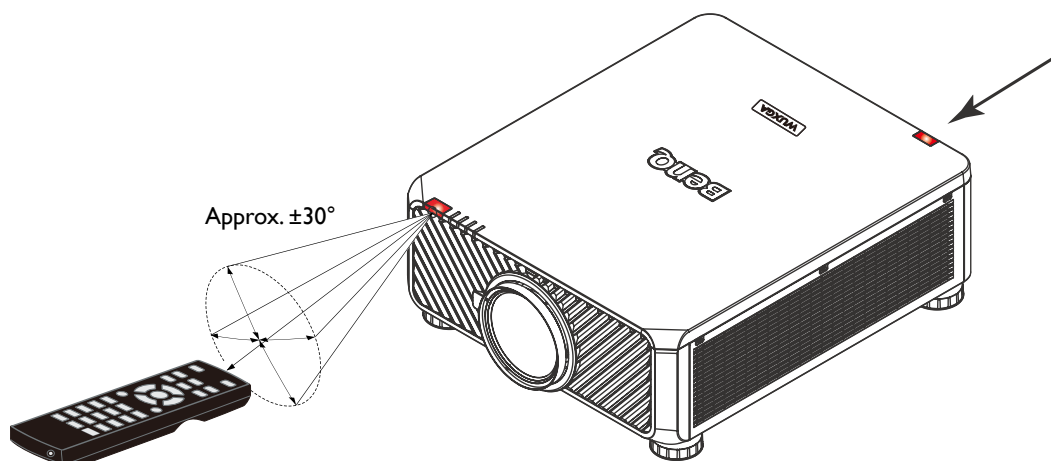

## Replacing the remote control battery

1. To open the battery cover, turn the remote control over to view its back, push on the finger grip on the cover and slide it up in the direction of the arrow as illustrated. The cover will slide off.
2. Remove any existing batteries (if necessary) and install two AA batteries observing the battery polarities as indicated in the base of the battery compartment. Positive (+) goes to positive and negative (-) goes to negative.
3. Refit the cover by aligning it with the base and sliding it back down into position. Stop when it clicks into place.

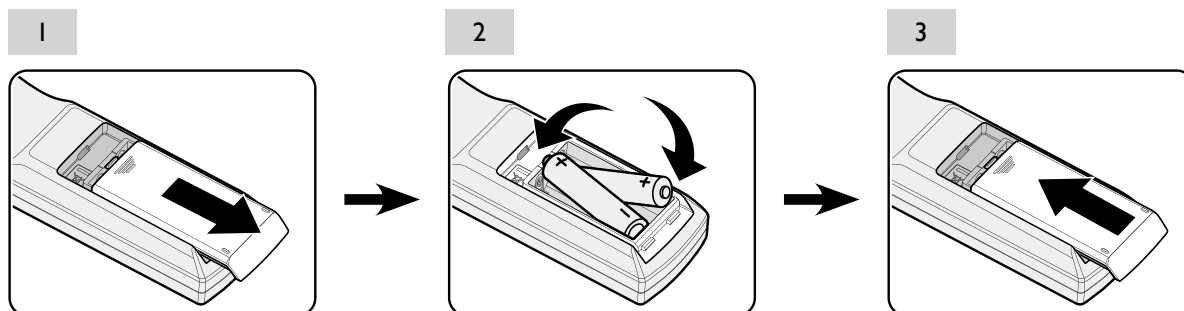

### Caution:

- Avoid excessive heat and humidity.
- There may be battery damage if the battery is incorrectly replaced.
- Replace only with the same or equivalent type recommended by the battery manufacturer.
- Dispose of the used battery according to the battery manufacturer's instructions.
- Never throw a battery into a fire. There may be danger of an explosion.
- If the battery is dead or if you will not be using the remote control for a long time, remove the battery to prevent damage to the remote control from possible battery leakage.

# Installation

## Caution:

To avoid damaging the DLP chips, never aim a high-power laser beam into the projection lens.

## Installing removing the optional lens

### Caution:

- Do not shake or place excessive pressure on the projector or the lens components as the projector and lens components contain precision parts.
- Before removing or installing the lens, be sure to turn off the projector, wait until the cooling fans stop, and turn off the main power switch.
- Do not touch the lens surface when removing or installing the lens.
- Keep fingerprints, dust or oil off the lens surface. Do not scratch the lens surface.
- Work on a level surface with a soft cloth under it to avoid scratching.
- If you remove and store the lens, attach the lens cap to the projector to keep off dust and dirt.

### Installing the new lens

Remove both end caps from the lens.

### Note:

Removal of the plastic body cap before inserting a lens for the first time.

1. Orient the lens so that the arrow on the label pasted on its side is facing upward and push the lens into the lens mount of the unit as far as it will go.

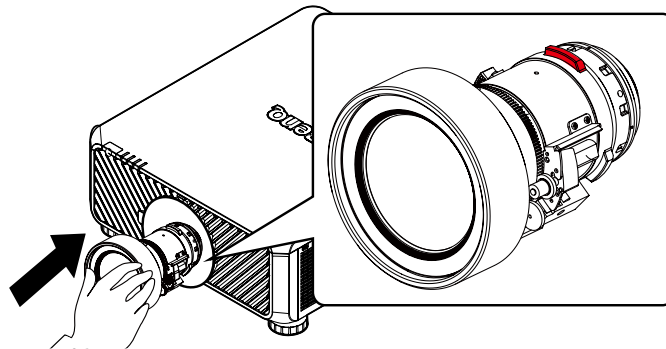

2. Rotate the lens clockwise until you feel it click into place.

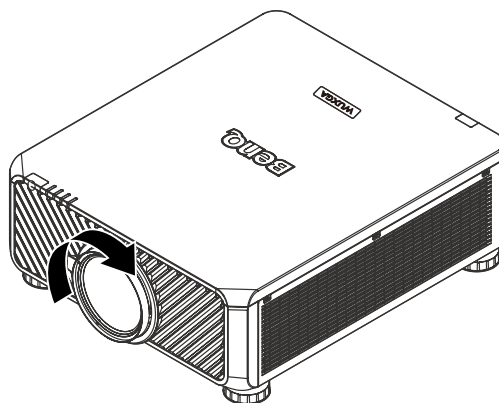

## Removing the existing lens from the projector

1. Push the LENSE RELEASE button to the unlock position.

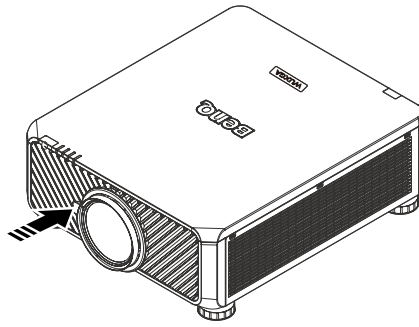

2. Grasp the lens.
3. Rotate the lens counterclockwise. The existing lens will be disengaged.

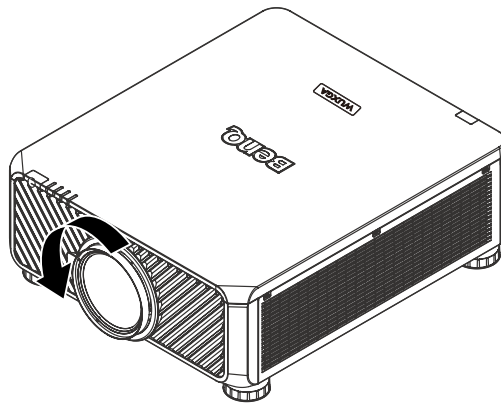

4. Pull out the existing lens slowly.

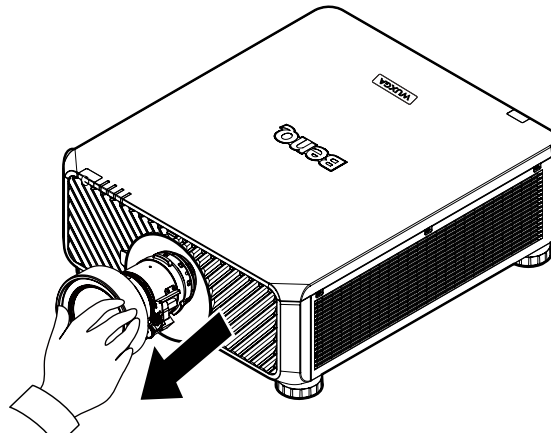

## Evaluate for distance by image size

### Obtaining a preferred projected image size

The distance from the projector lens to the screen, the zoom setting (if available), and the video format each factors in the projected image size.

### Projection dimensions

Refer to "Dimensions" on page 74 for the center of lens dimensions of this projector before calculating the appropriate position.

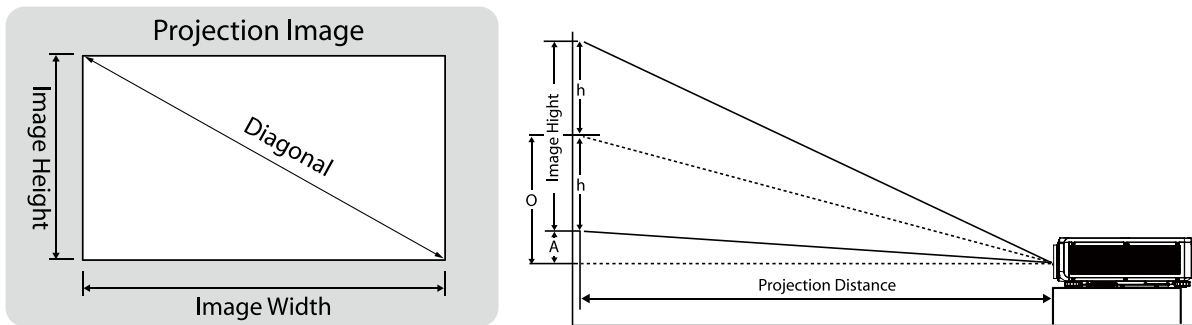

\*\*\* "A" is based on maximum lens shift offset position 55%

## LU9750/LU9800

The screen aspect ratio is 16:10 and the projected picture is 16:10.

### Note:

To optimize the projection quality, we suggest to project images in an area without grayscale.

Lens										Wide Zoom 2 (LS2ST2A)				Standard (LSISDA)			
Throw ratio										1.1~1.3				1.54~1.93			
Diagonal		Image Width		Image Height		Offset (A)		O		Distance				Distance			
						Wide/Tele		Wide/Tele		Wide		Tele		Wide		Tele	
(Inch)	(m)	(Inch)	(m)	(Inch)	(m)	(Inch)	(m)	(Inch)	(m)	(Inch)	(m)	(Inch)	(m)	(Inch)	(m)	(Inch)	(m)
50	1.27	42	1.08	26	0.67	1.3	0.034	14.6	0.370	47	1.18	55	1.40	65	1.66	82	2.08
60	1.52	51	1.29	32	0.81	1.6	0.040	17.5	0.444	56	1.42	66	1.68	78	1.99	98	2.49
80	2.03	68	1.72	42	1.08	2.1	0.054	23.3	0.592	75	1.90	88	2.24	104	2.65	131	3.33
100	2.54	85	2.15	53	1.35	2.6	0.067	29.1	0.740	93	2.37	110	2.80	131	3.32	164	4.16
120	3.05	102	2.58	64	1.62	3.2	0.081	35.0	0.888	112	2.84	132	3.36	157	3.98	196	4.99
150	3.81	127	3.23	79	2.02	4.0	0.101	43.7	1.111	140	3.55	165	4.20	196	4.98	245	6.24
180	4.57	153	3.88	95	2.42	4.8	0.121	52.5	1.333	168	4.26	198	5.04	235	5.97	295	7.48
200	5.08	170	4.31	106	2.69	5.3	0.135	58.3	1.481	187	4.74	220	5.60	261	6.63	327	8.31
250	6.35	212	5.38	132	3.37	6.6	0.168	72.9	1.851	233	5.92	276	7.00	326	8.29	409	10.39
300	7.62	254	6.46	159	4.04	7.9	0.202	87.4	2.221	280	7.11	331	8.40	392	9.95	491	12.47
350	8.89	297	7.54	185	4.71	9.3	0.236	102.0	2.591	326	8.29	386	9.80	457	11.61	573	14.55
400	10.16	339	8.62	212	5.38	10.6	0.269	116.6	2.962	373	9.48	441	11.20	522	13.27	655	16.63
500	12.70	424	10.77	265	6.73	13.2	0.337	145.7	3.702	466	11.85	551	14.00	653	16.59	818	20.79

Lens										Short Throw (LSIST3A)				Semi Throw (LS2ST4)			
Throw ratio										0.77~1.1				1.25~1.60			
Diagonal		Image Width		Image Height		Offset (A)		O		Distance				Distance			
						Wide/Tele		Wide/Tele		Wide		Tele		Wide		Tele	
(Inch)	(m)	(Inch)	(m)	(Inch)	(m)	(Inch)	(m)	(Inch)	(m)	(Inch)	(m)	(Inch)	(m)	(Inch)	(m)	(Inch)	(m)
50	1.27	42	1.08	26	0.67	1.3	0.034	14.6	0.370	33	0.83	47	1.18	53	1.35	68	1.72
60	1.52	51	1.29	32	0.81	1.6	0.040	17.5	0.444	39	1.00	56	1.42	64	1.62	81	2.07
80	2.03	68	1.72	42	1.08	2.1	0.054	23.3	0.592	52	1.33	75	1.90	85	2.15	109	2.76
100	2.54	85	2.15	53	1.35	2.6	0.067	29.1	0.740	65	1.66	93	2.37	106	2.69	136	3.45
120	3.05	102	2.58	64	1.62	3.2	0.081	35.0	0.888	78	1.99	112	2.84	127	3.23	163	4.14
150	3.81	127	3.23	79	2.02	4.0	0.101	43.7	1.111	98	2.49	140	3.55	159	4.04	204	5.17
180	4.57	153	3.88	95	2.42	4.8	0.121	52.5	1.333	118	2.99	168	4.26	191	4.85	244	6.20
200	5.08	170	4.31	106	2.69	5.3	0.135	58.3	1.481	131	3.32	187	4.74	212	5.38	271	6.89
250	6.35	212	5.38	132	3.37	6.6	0.168	72.9	1.851	163	4.15	233	5.92	265	6.73	339	8.62
300	7.62	254	6.46	159	4.04	7.9	0.202	87.4	2.221	196	4.98	280	7.11	318	8.08	407	10.34
350	8.89	297	7.54	185	4.71	9.3	0.236	102.0	2.591	229	5.80	326	8.29	371	9.42	475	12.06
400	10.16	339	8.62	212	5.38	10.6	0.269	116.6	2.962	261	6.63	373	9.48	424	10.77	543	13.79
500	12.70	424	10.77	265	6.73	13.2	0.337	145.7	3.702	326	8.29	466	11.85	530	13.46	678	17.23

Lens										Semi Long (LSILT0)			
Throw ratio										1.93~2.9			
Diagonal		Image Width		Image Height		Offset (A)		O		Distance			
						Wide/Tele		Wide/Tele		Wide		Tele	
(Inch)	(m)	(Inch)	(m)	(Inch)	(m)	(Inch)	(m)	(Inch)	(m)	(Inch)	(m)	(Inch)	(m)
50	1.27	42	1.08	26	0.67	1.3	0.034	14.6	0.370	82	2.08	123	3.12
60	1.52	51	1.29	32	0.81	1.6	0.040	17.5	0.444	98	2.49	148	3.75
80	2.03	68	1.72	42	1.08	2.1	0.054	23.3	0.592	131	3.33	197	5.00
100	2.54	85	2.15	53	1.35	2.6	0.067	29.1	0.740	164	4.16	246	6.25
120	3.05	102	2.58	64	1.62	3.2	0.081	35.0	0.888	196	4.99	295	7.50
150	3.81	127	3.23	79	2.02	4.0	0.101	43.7	1.111	245	6.24	369	9.37
180	4.57	153	3.88	95	2.42	4.8	0.121	52.5	1.333	295	7.48	443	11.24
200	5.08	170	4.31	106	2.69	5.3	0.135	58.3	1.481	327	8.31	492	12.49
250	6.35	212	5.38	132	3.37	6.6	0.168	72.9	1.851	409	10.39	615	15.62
300	7.62	254	6.46	159	4.04	7.9	0.202	87.4	2.221	491	12.47	738	18.74
350	8.89	297	7.54	185	4.71	9.3	0.236	102.0	2.591	573	14.55	861	21.86
400	10.16	339	8.62	212	5.38	10.6	0.269	116.6	2.962	655	16.63	984	24.99
500	12.70	424	10.77	265	6.73	13.2	0.337	145.7	3.702	818	20.79	1230	31.23

Lens										Semi Long 2 (LSILT1)				Long Zoom 1 (LSILT2)			
Throw ratio										2.22~3.67				3.58~5.38			
Diagonal		Image Width		Image Height		Offset (A)		O		Distance				Distance			
						Wide/Tele		Wide/Tele		Wide		Tele		Wide		Tele	
(Inch)	(m)	(Inch)	(m)	(Inch)	(m)	(Inch)	(m)	(Inch)	(m)	(Inch)	(m)	(Inch)	(m)	(Inch)	(m)	(Inch)	(m)
50	1.27	42	1.08	26	0.67	0.0	0.000	13.2	0.337	94	2.39	156	3.95	152	3.86	228	5.79
60	1.52	51	1.29	32	0.81	0.0	0.000	15.9	0.404	113	2.87	187	4.74	182	4.63	274	6.95
80	2.03	68	1.72	42	1.08	0.0	0.000	21.2	0.538	151	3.83	249	6.32	243	6.17	365	9.27
100	2.54	85	2.15	53	1.35	0.0	0.000	26.5	0.673	188	4.78	311	7.90	304	7.71	456	11.59
120	3.05	102	2.58	64	1.62	0.0	0.000	31.8	0.808	226	5.74	373	9.49	364	9.25	547	13.91
150	3.81	127	3.23	79	2.02	0.0	0.000	39.7	1.010	282	7.17	467	11.86	455	11.57	684	17.38
180	4.57	153	3.88	95	2.42	0.0	0.000	47.7	1.212	339	8.61	560	14.23	546	13.88	821	20.86
200	5.08	170	4.31	106	2.69	0.0	0.000	53.0	1.346	377	9.56	622	15.81	607	15.42	912	23.18
250	6.35	212	5.38	132	3.37	0.0	0.000	66.2	1.683	471	11.95	778	19.76	759	19.28	1141	28.97
300	7.62	254	6.46	159	4.04	0.0	0.000	79.5	2.019	565	14.35	934	23.71	911	23.13	1369	34.76
350	8.89	297	7.54	185	4.71	0.0	0.000	92.7	2.356	659	16.74	1089	27.67	1063	26.99	1597	40.56
400	10.16	339	8.62	212	5.38	0.0	0.000	106.0	2.692	753	19.13	1245	31.62	1214	30.84	1825	46.35
500	12.70	424	10.77	265	6.73	0.0	0.000	132.5	3.365	941	23.91	1556	39.52	1518	38.56	2281	57.94



Lens										Long Zoom 2 (LSILT3)			
Throw ratio										5.31~8.26			
Diagonal		Image Width		Image Height		Offset (A)		O		Distance			
						Wide/Tele		Wide/Tele		Wide		Tele	
(Inch)	(m)	(Inch)	(m)	(Inch)	(m)	(Inch)	(m)	(Inch)	(m)	(Inch)	(m)	(Inch)	(m)
50	1.27	42	1.08	26	0.67	0.0	0.000	13.2	0.337	225	5.72	350	8.90
60	1.52	51	1.29	32	0.81	0.0	0.000	15.9	0.404	270	6.86	420	10.67
80	2.03	68	1.72	42	1.08	0.0	0.000	21.2	0.538	360	9.15	560	14.23
100	2.54	85	2.15	53	1.35	0.0	0.000	26.5	0.673	450	11.44	700	17.79
120	3.05	102	2.58	64	1.62	0.0	0.000	31.8	0.808	540	13.72	841	21.35
150	3.81	127	3.23	79	2.02	0.0	0.000	39.7	1.010	675	17.16	1051	26.69
180	4.57	153	3.88	95	2.42	0.0	0.000	47.7	1.212	811	20.59	1261	32.02
200	5.08	170	4.31	106	2.69	0.0	0.000	53.0	1.346	901	22.87	1401	35.58
250	6.35	212	5.38	132	3.37	0.0	0.000	66.2	1.683	1126	28.59	1751	44.48
300	7.62	254	6.46	159	4.04	0.0	0.000	79.5	2.019	1351	34.31	2101	53.37
350	8.89	297	7.54	185	4.71	0.0	0.000	92.7	2.356	1576	40.03	2452	62.27
400	10.16	339	8.62	212	5.38	0.0	0.000	106.0	2.692	1801	45.75	2802	71.17
500	12.70	424	10.77	265	6.73	0.0	0.000	132.5	3.365	2251	57.19	3502	88.96

Lens										Ultra Short Throw (LSIST4)	
Throw ratio										0.377	
Diagonal		Image Width		Image Height		Offset (A)		O		Distance	
						Wide/Tele		Wide/Tele		Wide	
(Inch)	(m)	(Inch)	(m)	(Inch)	(m)	(Inch)	(m)	(Inch)	(m)	(Inch)	(m)
50	1.27	42	1.08	26	0.67	12.1	0.306	25.3	0.643	16	0.41
60	1.52	51	1.29	32	0.81	14.5	0.368	30.4	0.771	19	0.49
80	2.03	68	1.72	42	1.08	19.3	0.490	40.5	1.028	26	0.65
100	2.54	85	2.15	53	1.35	24.1	0.613	50.6	1.286	32	0.81
120	3.05	102	2.58	64	1.62	28.9	0.735	60.7	1.543	38	0.97
150	3.81	127	3.23	79	2.02	36.2	0.919	75.9	1.928	48	1.22
180	4.57	153	3.88	95	2.42	43.4	1.103	91.1	2.314	58	1.46
200	5.08	170	4.31	106	2.69	48.2	1.225	101.2	2.571	64	1.62
250	6.35	212	5.38	132	3.37	60.3	1.531	126.5	3.214	80	2.03
300	7.62	254	6.46	159	4.04	72.3	1.838	151.8	3.857	96	2.44
350	8.89	297	7.54	185	4.71	84.4	2.144	177.2	4.500	112	2.84
400	10.16	339	8.62	212	5.38	96.5	2.450	202.5	5.142	128	3.25
500	12.70	424	10.77	265	6.73	120.6	3.063	253.1	6.428	160	4.06

 **Note:**

There is 5% tolerance among these numbers due to optical component variations. BenQ recommends that if you intend to permanently install the projector, you should physically test the projection size and distance using the actual projector before you permanently install it, so as to make allowance for this projector's optical characteristics. This will help you determine the exact mounting position so that it best suits your installation location.

### Lens dimension

**Optional Lens (Standard: LSISDA)**

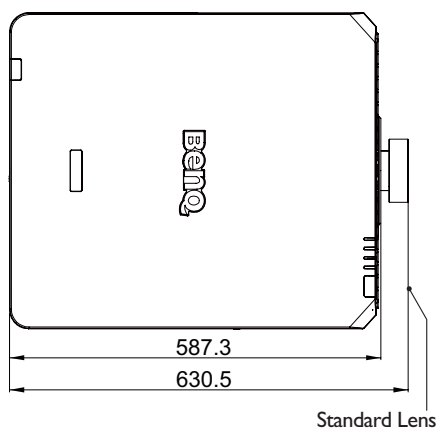

**Optional Lens (Semi Long 2: LSILTI)**

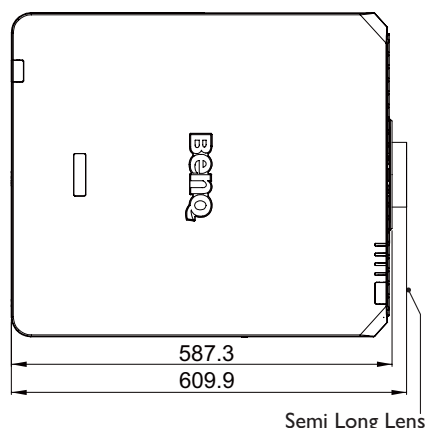

**Optional Lens (Short Throw: LSIST3A)**

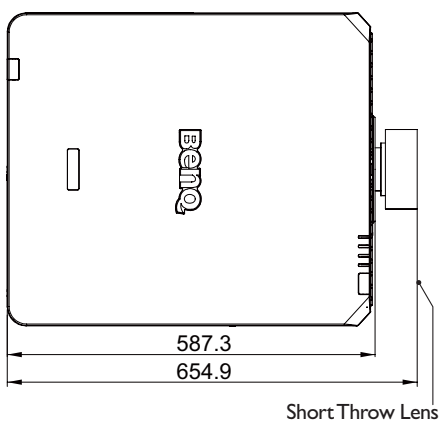

**Optional Lens (Long 1: LSILT2)**

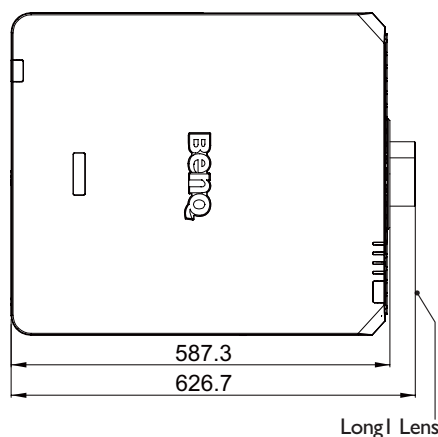

**Optional Lens (Wide Zoom 1: LSISTIA)**

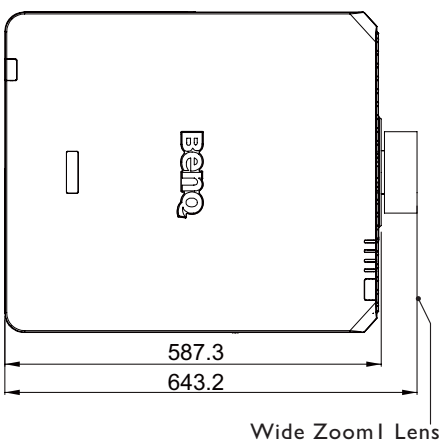

**Optional Lens (Long 2: LSILT3)**

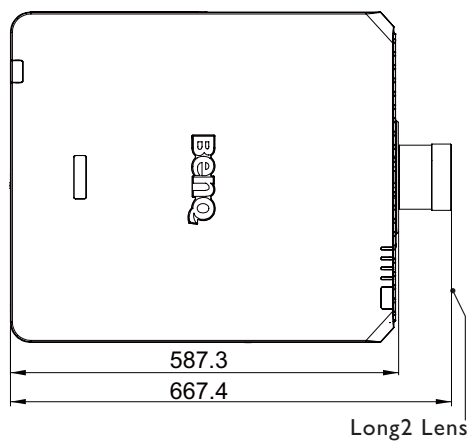

**Optional Lens (Semi Long: LSILT0)**

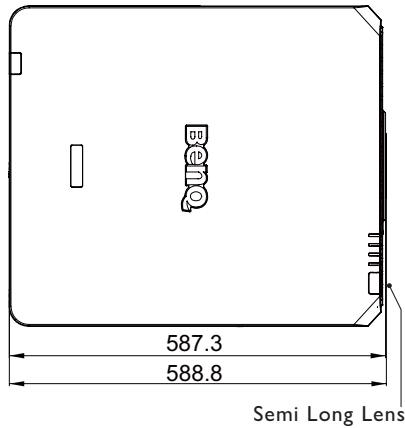

Semi Long Lens

**Optional Lens (Ultra Short Throw: LSIST4)**

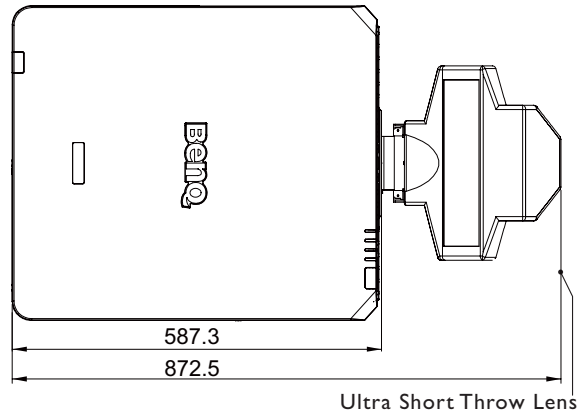

Ultra Short Throw Lens

**Optional Lens (Wide Zoom 2: LSIST2A)**

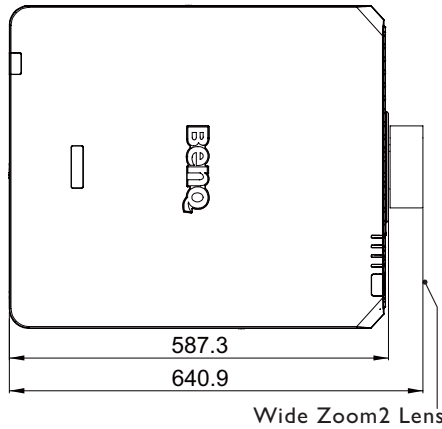

Wide Zoom2 Lens

## Adjusting by Lens shift

The Lens Shift function can be used to adjust the position of the projected image either horizontally or vertically within the range detailed below.

### Adjusting the vertical image position

The vertical image height can be adjusted between 55% and -15% for WUXGA of offset position. Please consult the Lens Shift Range diagram below for further clarification.

### Adjusting the horizontal image position

With the lens in the center position the horizontal image position can be adjusted to the left or right by up to a maximum of 5% of the image width. Please consult the Lens Shift Range diagram below for further clarification.

## Lens shift range diagram

The adjustable range for lens shift is tabulated below and subject to the conditions listed.



### Note:

The drawings below apply to the standard lens only.

### Desk-Front Projection

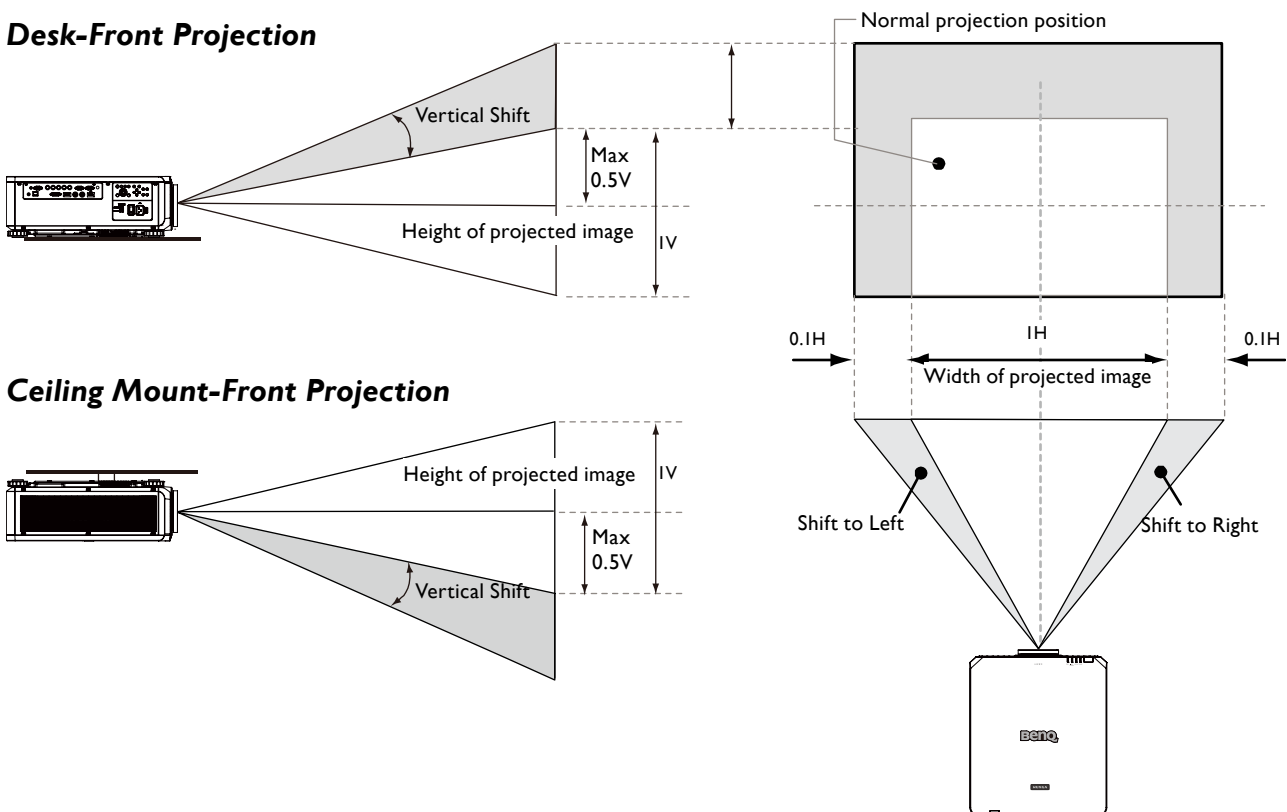

### Ceiling Mount-Front Projection

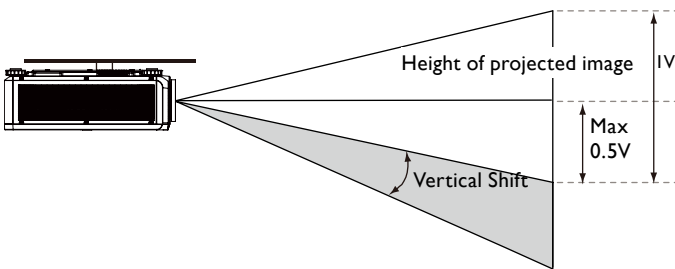

### Notice (when edge blending)

- To avoid the image shaking or some pixels in the display may be misaligned, do not use the projector in the following location:
  - In a building close to a construction site.
  - In a room where an air conditioner unit is working and it vibrates.
  - In a place where the temperature changes dramatically that may cause thermal contraction.
- Before making any adjustment, leave the projector lit for at least 45 minutes after its light source is turned on. This allows the internal temperature of the projector to stabilize.

## Connection

### Before connecting

- Before connecting, carefully read the operating instructions for connecting the external device
- Turn off the power to all devices before connecting cables.
- Take note of the following before connecting cables. Failure to do so may result in malfunctions.
  - Before connecting a cable to the projector or to a device that is connected to the projector, touch any nearby metallic objects to remove any static electricity from your body.
  - Do not use unnecessarily long cables to connect the projector or a device to the projector. Using a longer cable that is wound makes it act like an antenna, making it more susceptible to noise.
  - When connecting cables, connect GND first and then insert the connecting terminal of the connecting device.
- Acquire any connection cables necessary to connect external devices to the system that are not supplied.
- The images on the screen may wobble if the video signal contains too much jitter. In this case, a time base corrector (TBC) must be connected.
- If synchronization signal outputs from computers or video equipment are disrupted due to changes in the video output settings or any other reasons, the colors of projected images may be temporarily disrupted.
- The projector accepts video signals, Y/C signals, YCBCR/YPBPR signals, analog RGB signals (synchronization signals are TTL level), and digital signals.
- Some computer models are not compatible with the projector.
- Use a cable compensator when you connect devices to the projector with long cables. If a cable compensator is not used, the image may not display properly.

### PC

No.	Serial
1	R/PR
2	G/Y
3	B/PB
4	-
5	GND
6	GND
7	GND
8	GND

No.	Serial
9	-
10	GND
11	GND
12	DDC data
13	SYNC/HD
14	VD
15	DDC clock

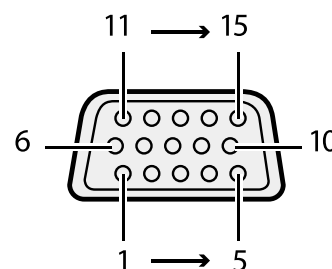

## HDMI I

No.	Serial
1	TMDS Data2+
2	TMDS Data2 Shield
3	TMDS Data2-
4	TMDS Data1+
5	TMDS Data1 Shield
6	TMDS Data1-
7	TMDS Data0+
8	TMDS Data0 Shield
9	TMDS Data0-
10	TMDS Clock+

No.	Serial
11	TMDS Clock Shield
12	TMDS Clock-
13	CEC
14	Reserved (N.C. on device)
15	SCL
16	SDA
17	DDC/CEC Ground
18	+5 V Power (max 50 mA)
19	Hot Plug Detect

Even-numbered pins of 2 to 18

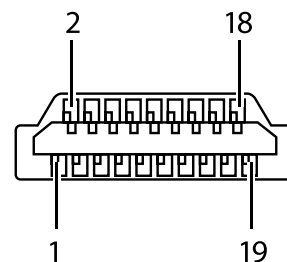

Odd-numbered pins of 1 to 19

## DVI-D

No.	Serial
1	T.M.D.S data 2-
2	T.M.D.S data 2+
3	T.M.D.S data 2/4 shield
4	-
5	-
6	DDC clock
7	DDC data
8	-
9	T.M.D.S data 1-
10	T.M.D.S clock1+
11	T.M.D.S data 1/3 shield
12	-

No.	Serial
13	-
14	-+5 V
15	GND
16	Hot plug detection
17	T.M.D.S data 0-
18	T.M.D.S data 0+
19	T.M.D.S data 0/5 shield
20	-
21	-
22	T.M.D.S clock shield
23	T.M.D.S clock+
24	T.M.D.S clock-

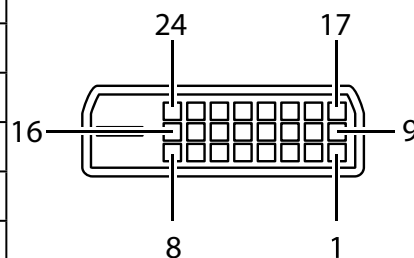

## Connecting with AV equipment

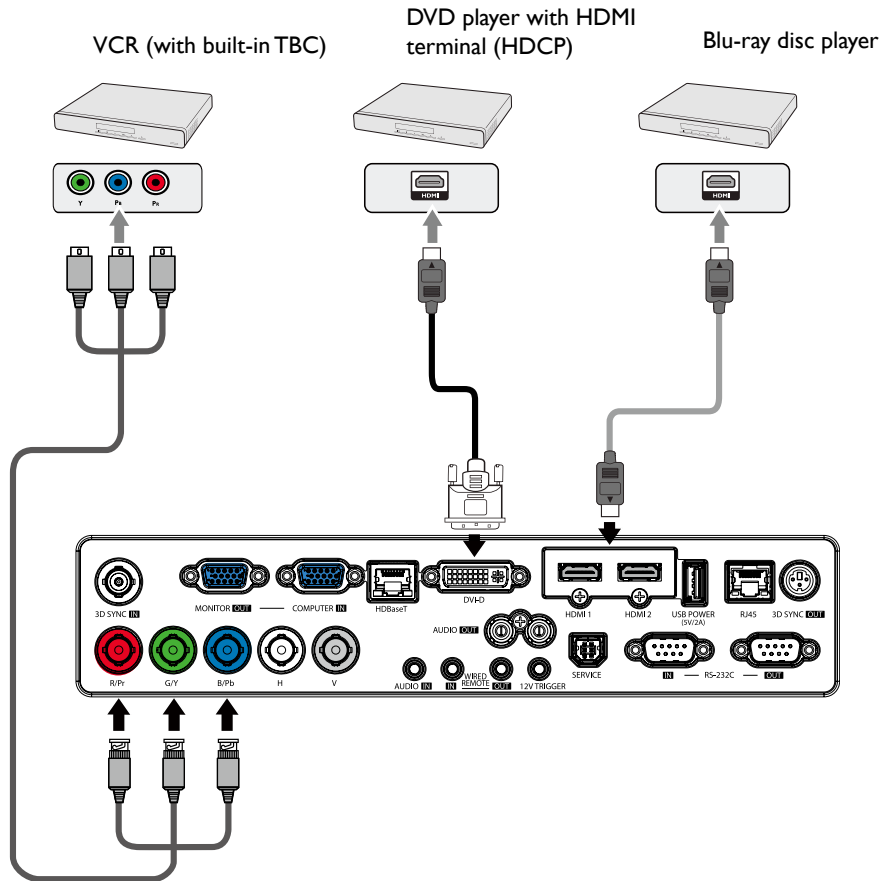

## Connecting with computer

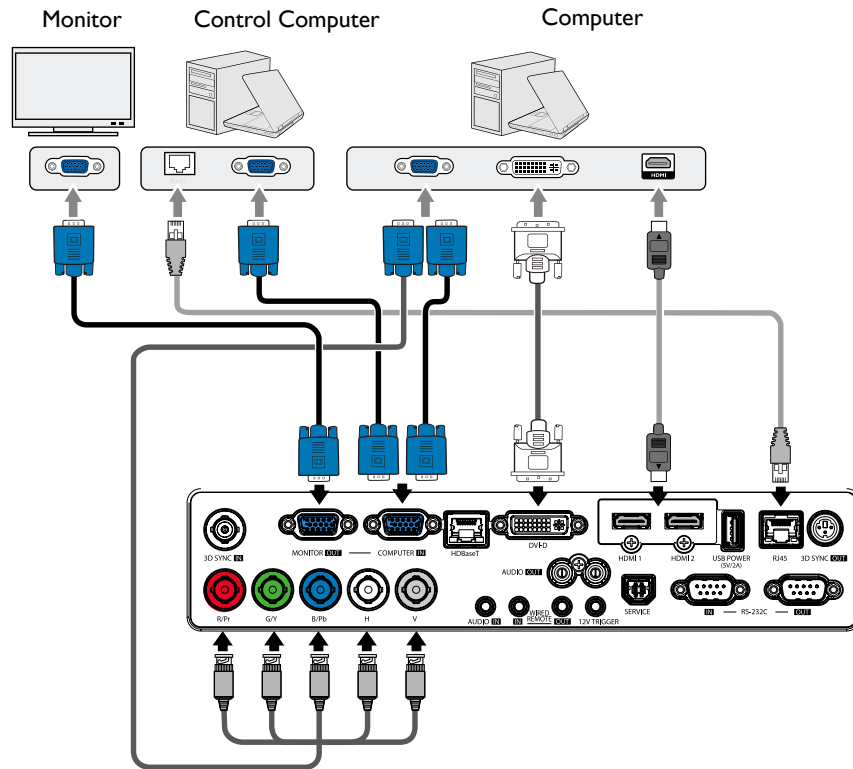

## Connecting with HDBaseT transmitter

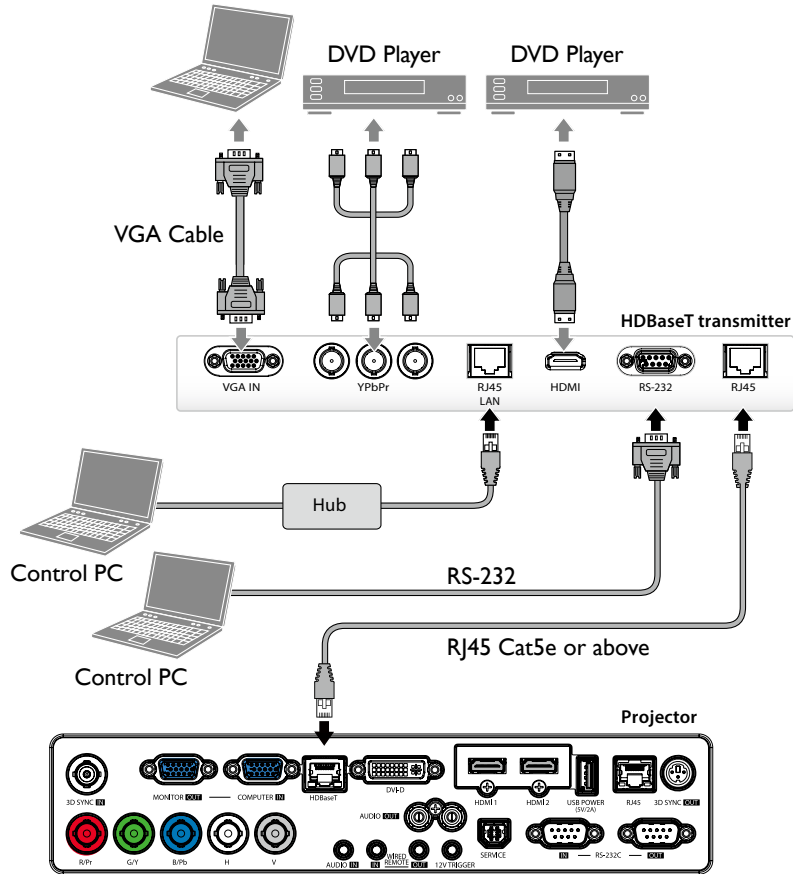

## Connecting with LAN

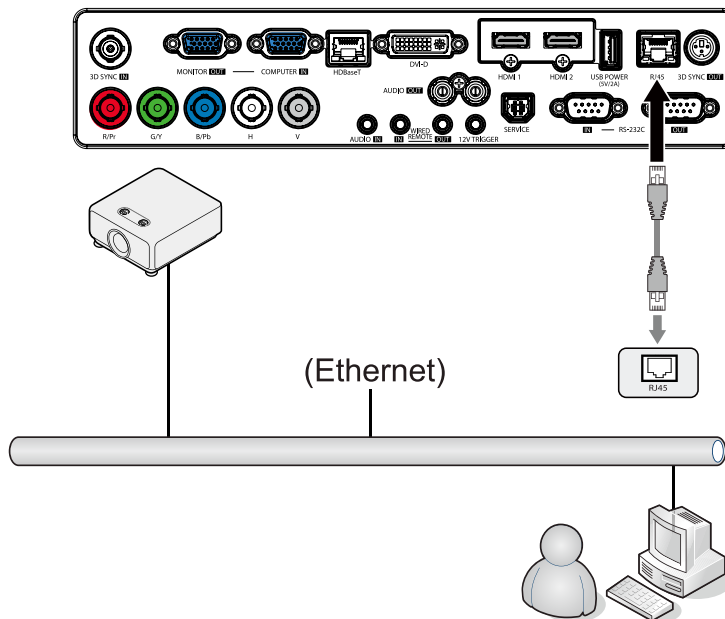



# Operations

## Switch on/off the projector

### Connecting the power cord

Plug the power cord into the projector and into a wall socket. Turn on the wall socket switch (where fitted). Check that the POWER indicator light on the projector lights orange after power has been applied.

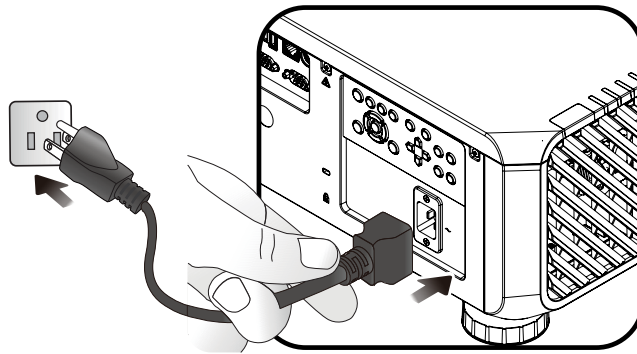

### Caution:

Please use the original accessories (e.g. power cable) only with the device to avoid possible dangers such as electric shock and fire.

### Power indicator

Power	Temp	Light	Filter	Status & Description
Orange	-	-	-	Stand-by
Green Flashing	-	-	-	Powering up
Green	-	-	-	Normal operation
Orange Flashing	-	-	-	Normal power down cooling

## Switch on the projector

Press **POWER** on the projector or **ON** on the remote control to start the projector and a start up tone sounds. The **POWER** indicator light flashes green and stays green when the projector is on.

The start up procedure takes about 30 seconds. In the later stage of start up, a startup logo is projected.

(If necessary) Rotate the focus ring to adjust the image clearness.

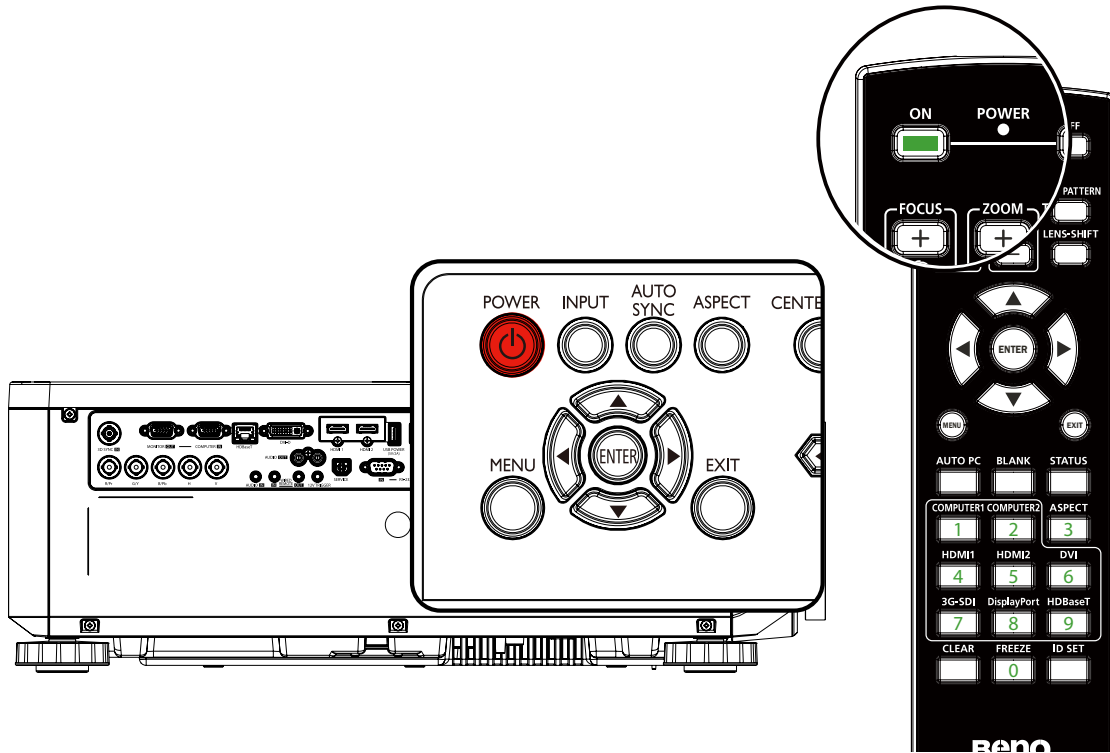

## Select language

To use the OSD menus, please set them to your familiar language first.

Please Select Language			
English	한국어	Hrvatski	हिन्दी
Français	Svenska	Română	
Deutsch	Nederlands	Norsk	
Italiano	Türkçe	Dansk	
Español	Čeština	Български	
Русский	Português	suomi	
繁體中文	ไทย	Indonesian	
简体中文	Polski	Ελληνικά	
日本語	Magyar	العربية	
Press Enter to confirm, Exit to leave			

\*After this process is done, this menu will not show up again after 1st time adjustment unless user presses **Reset All Settings**.

1. Press **ENTER** on the projector or remote control to turn the OSD menu on.

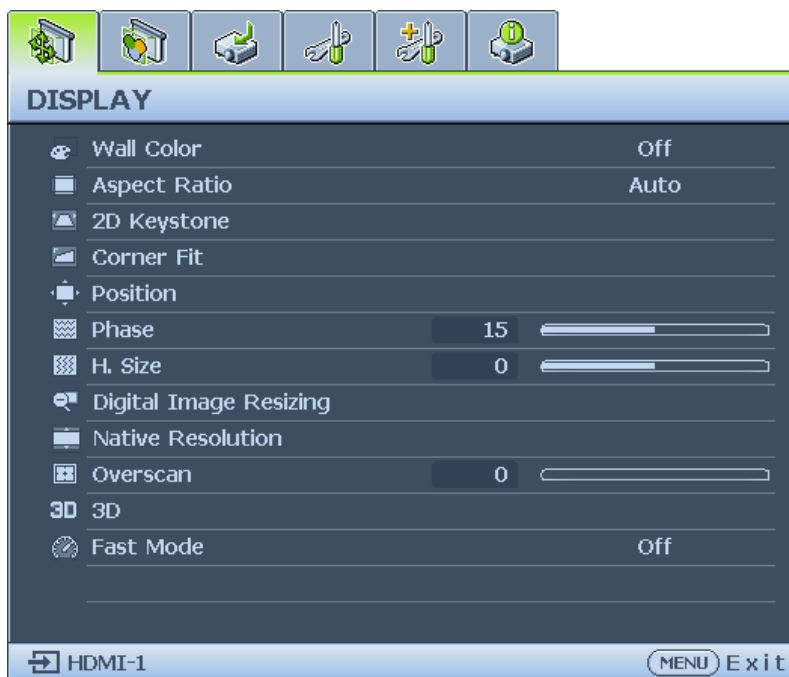

2. Use ◀/▶ to highlight the **System Setup: Basic** menu.

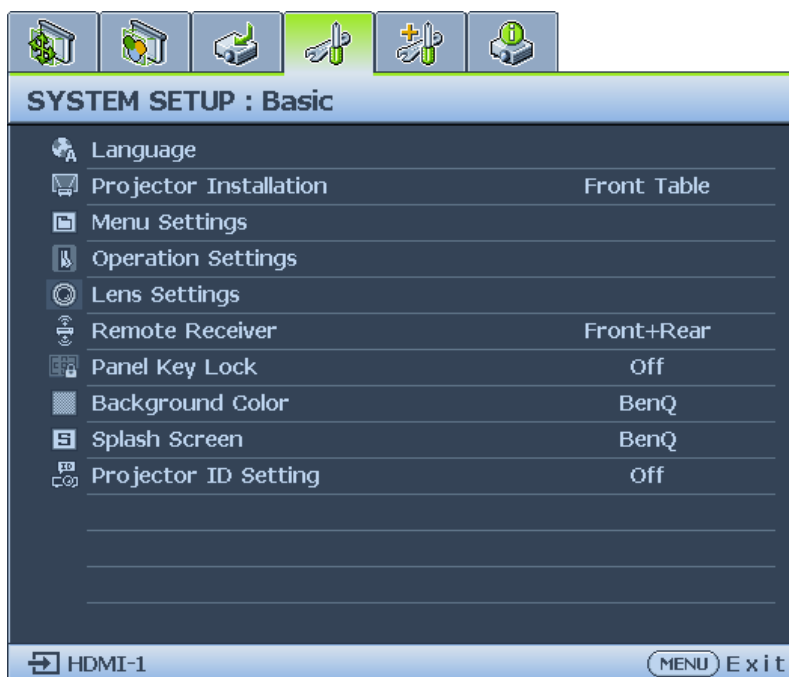

3. Press ▼ to highlight **Language** and press **ENTER** to select a preferred language.



4. Press **ENTER** twice\* on the projector or remote control to leave and save the settings.

\*The first press leads you back to the main menu and the second press closes the OSD menu.

## Using the OSD

### Choosing a location

Your projector is designed to be installed in one of four possible installation locations:

#### 1. Front Table

Select this location with the projector placed on a table in front of the screen. This is the most common way to position the projector for quick setup and portability.

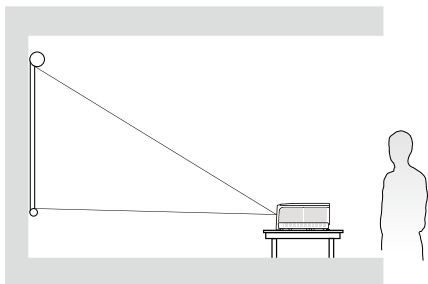

#### 2. Rear Table

Select this location with the projector placed on a table behind the screen. Note that a special rear projection screen is required.

\*Set **Rear Table** in the **SYSTEM SETUP: Basic > Projector Installation** menu after you turn the projector on.

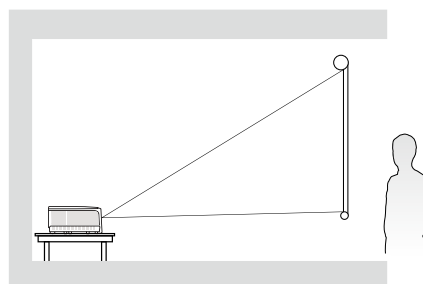

#### 3. Front Ceiling

Select this location with the projector suspended upside-down from the ceiling in front of the screen.

Purchase the BenQ Projector Ceiling Mounting Kit from your dealer to mount your projector on the ceiling.

\*Set **Front Ceiling** in the **SYSTEM SETUP: Basic > Projector Installation** menu after you turn the projector on.

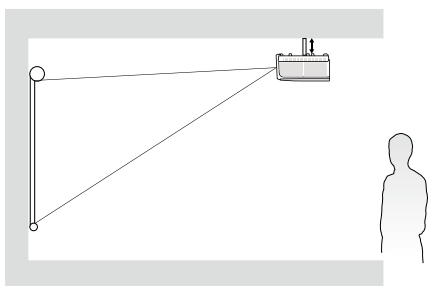

#### 4. Rear Ceiling

Select this location with the projector suspended upside-down from the ceiling behind the screen.

Note that a special rear projection screen and the BenQ Projector Ceiling Mounting Kit are required for this installation location.

\*Set **Rear Ceiling** in the **SYSTEM SETUP: Basic > Projector Installation** menu after you turn the projector on.

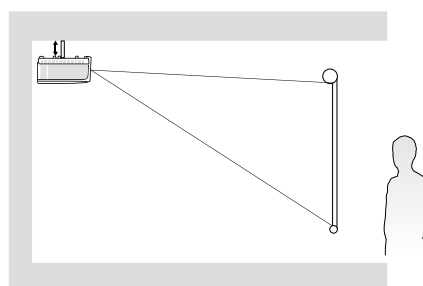

Your room layout or personal preference will dictate which installation location you select. Take into consideration the size and position of your screen, the location of a suitable power outlet, as well as the location and distance between the projector and the rest of your equipment.

## Using test pattern

The projector is capable of displaying the grid test pattern. It can be used to assist you with the adjustment of image size and focus, ensuring that the projected image is free from distortion. To display the test pattern, open the OSD menu and go to the **System Setup: Advanced > Test Pattern** and press ◀/▶ to select On.

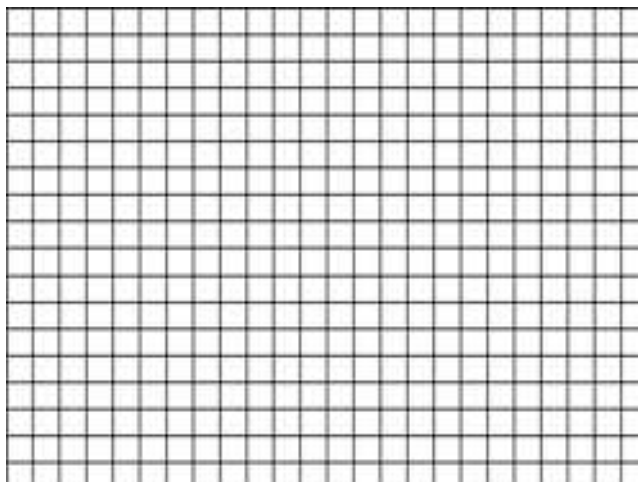

## Adjusting by corner fit

Manually adjust four corners of the image by setting the horizontal and vertical values. Using the OSD menu

1. Press **MENU** and then press ◀/▶ until the **Display** menu is highlighted.
2. Press ▼ to highlight **Corner Fit** and press **ENTER**. The **Corner Fit** page displays.



3. Press ▲/▼/◀/▶ to select one of the four corners and press **ENTER**.

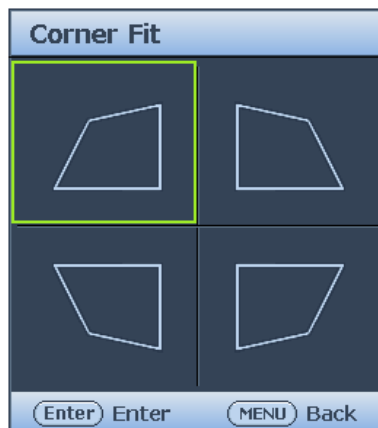

4. Press ▲/▼ to adjust vertical values from 0 to 60.

5. Press ◀/▶ to adjust horizontal values from 0 to 60.

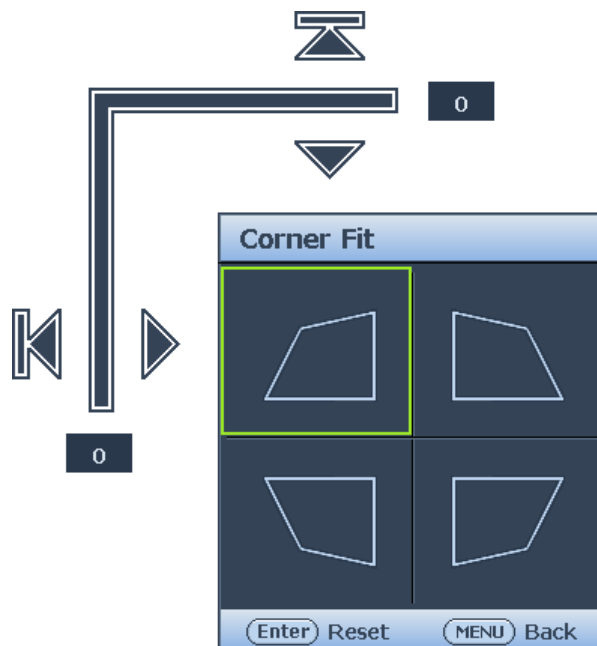

### Auto adjusting the image

In some cases, you may need to optimize the picture quality. To do this, press **AUTO** on the projector or remote control. Within 3 seconds, the built-in Intelligent Auto Adjustment function will re-adjust the values of Frequency and Clock to provide the best picture quality.

The current source information will be displayed in the upper left corner of the screen for 3 seconds.

#### **Note:**

- The screen will be blank while AUTO is functioning.
- This function is only available when PC signal (analog RGB) is selected.

## Switch off the projector

1. Press **POWER** or **OFF** and a confirmation message will appear prompting you. If you don't respond in a few seconds, the message will disappear.
2. Press **POWER** or **OFF** a second time. The **POWER** indicator light flashes orange, the projection light source shuts down.

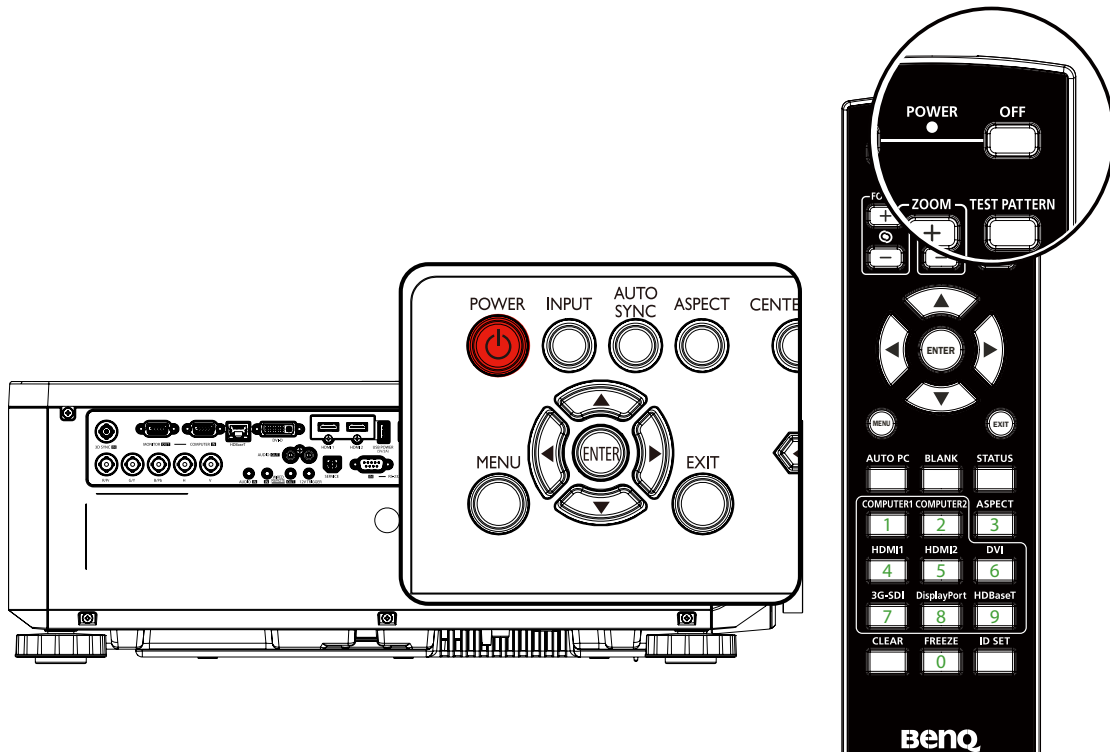

3. Once the cooling process finishes, a "**Power Off Ring Tone**" will be heard. The **POWER** indicator light is a steady orange and fans stop. Disconnect the power cord from the power outlet.

### **Caution:**

- To protect the light source, the projector will not respond to any commands during the cooling process.
- Press **POWER** or **ON** again to start the projector after the **POWER** indicator light turns orange.



# Using the menu

## Main menu

The projector is equipped with On-Screen Display (OSD) menus for making various adjustments and settings.

Below is the overview of the OSD menu.

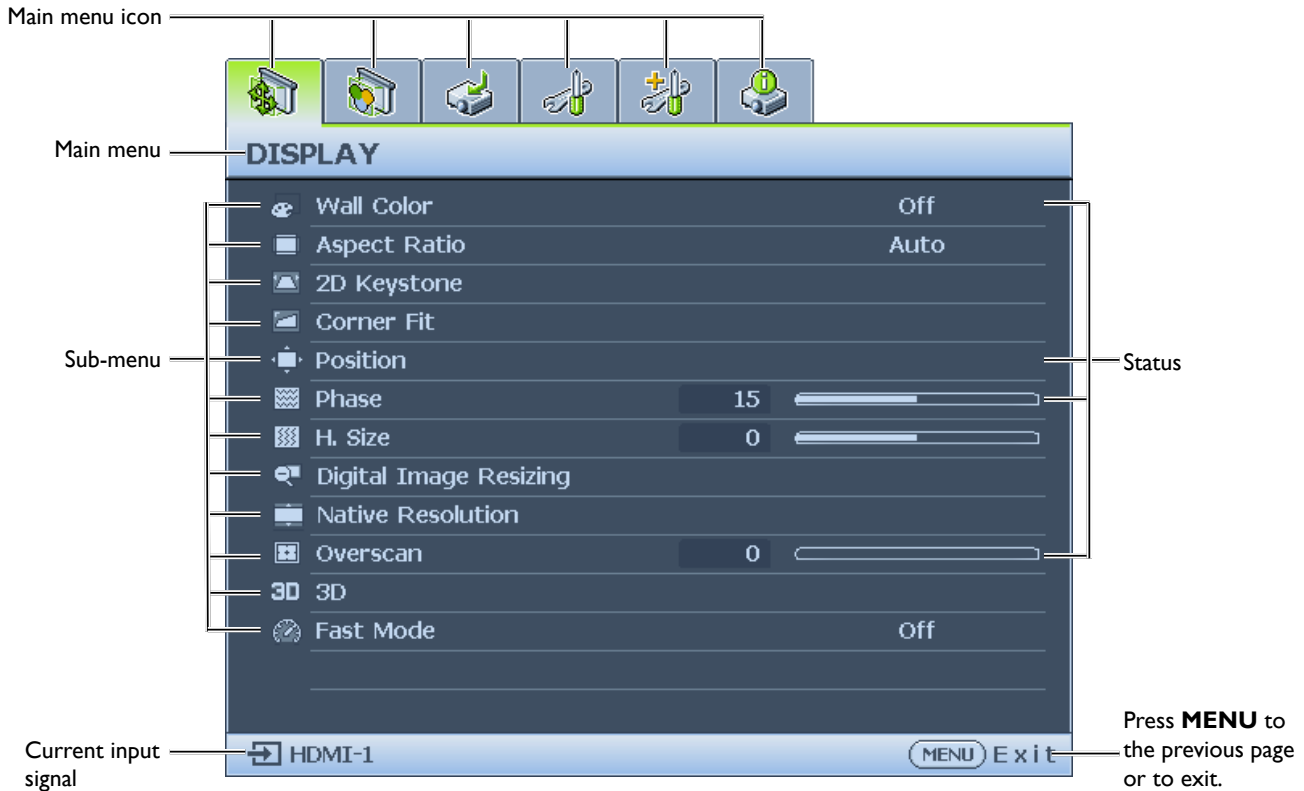

1. Display menu (see ["Display menu" on page 42](#))
2. Picture menu (see ["Picture menu" on page 47](#))
3. Source menu (see ["Source menu" on page 51](#))
4. System Setup : Basic menu (see ["System Setup : Basic menu" on page 53](#))
5. System Setup : Advanced menu (see ["System Setup : Advanced menu" on page 57](#))
6. Information menu (see ["Information menu" on page 62](#))

Available menu items may vary depending on the connected video sources or specified settings. Menu items that are not available will become grayed out.

- Use the arrow keys (▲/▼/◀/▶) on the projector or remote control to move through the menu items.
- Use **ENTER** to confirm the selected menu item.

## Display menu



- **Wall Color**

Press ◀/▶ to correct the image color bias reflected by the wall. The options are Off, Light Yellow, Pink, Light Green, Blue and Blackboard.

- **Aspect Ratio**

Press ◀/▶ to adjust the aspect of the projected image. The options are Auto, Real, 4:3, 16:9, 16:10 and 2.35:1.

- Using the remote control

1. Press **ASPECT** to show the current setting.
2. Press **ASPECT** repeatedly to select an aspect ratio to suit the format of the video signal and your display requirements.

1. **Auto:** Scales an image proportionally to fit the projector's native resolution in its horizontal width. This is suitable for the incoming image which is neither in 4:3 nor 16:9 and you want to make most use of the screen without altering the image's aspect ratio.

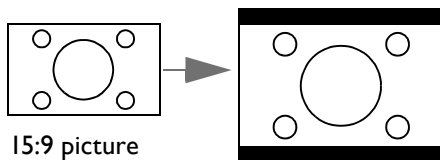

2. **Real:** The image is projected as its original resolution, and resized to fit within the display area. For input signals with lower resolutions, the projected image will display smaller than if resized to full screen. You could adjust the zoom setting or move the projector away from the screen to increase the image size if necessary. You may also need to refocus the projector after making these adjustments.

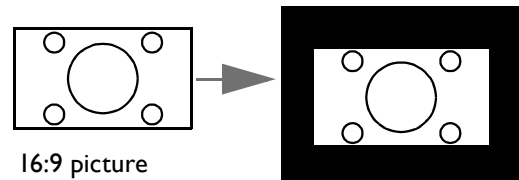
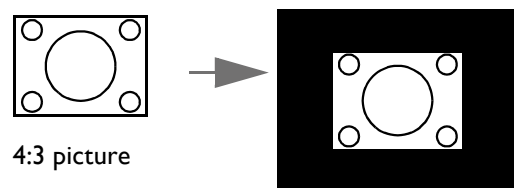

3. **4:3:** Scales an image so that it is displayed in the center of the screen with a 4:3 aspect ratio. This is most suitable for 4:3 images like computer monitors, standard definition TV and 4:3 images aspect DVD movies, as it displays them without aspect alteration.
4. **16:9:** Scales an image so that it is displayed in the center of the screen with a 16:9 aspect ratio. This is most suitable for images which are already in a 16:9 aspect, like high definition TV, as it displays them without aspect alteration.

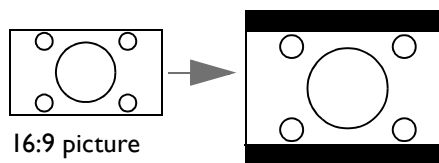
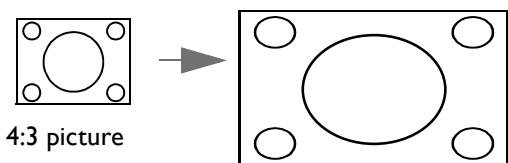

5. **16:10:** Scales an image so that it is displayed in the center of the screen with a 16:10 aspect ratio. This is most suitable for images which are already in a 16:10 aspect, as it displays them without aspect alteration.
6. **2.35:1:** Scales an image so that it is displayed in the center of the screen with a 2.35:1 aspect ratio. This is most suitable for widescreen cinemascope formats for movie theaters or images which already vary from a 2.35 to 2.40 aspect, as it displays them without aspect alteration.

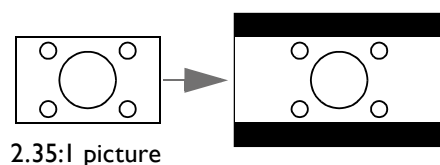
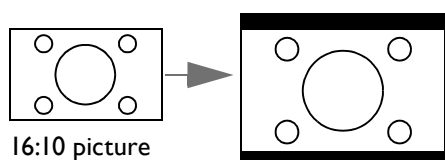

- **2D Keystone**

Press **ENTER** and press **▲/▼/◀/▶** to adjust horizontal or vertical distortion brought by the projection angle.

- **Corner Fit**

Press **ENTER** to enter the **Corner Fit** menu. See "[Corner Fit menu](#)" on page 44 for more details.

- **Position**

Press **ENTER** and press **▲/▼/◀/▶** to adjust the position of the projected picture.

- **Phase**

Press **◀/▶** to adjust Phase for the projected picture.

- **H. Size**

Press **◀/▶** to adjust H. Size for the projected picture.

- **Digital Image Resizing**

Press **ENTER** to enter the **Digital Image Resizing** menu. See "[Digital Image Resizing](#)" on page 44 for more details.

- **Native Resolution**

Press **ENTER** to enter the **Native Resolution** menu. See "[Native Resolution](#)" on page 45.

- **Overscan**

Press **◀/▶** to hide edge of the projected image to damage the noise.

- **3D**

Press **ENTER** to enter the **3D** menu. See "[3D menu](#)" on page 46 for more details.

- **Fast Mode**

Press **◀/▶** to enable or disable **Fast Mode**.

## Corner Fit menu

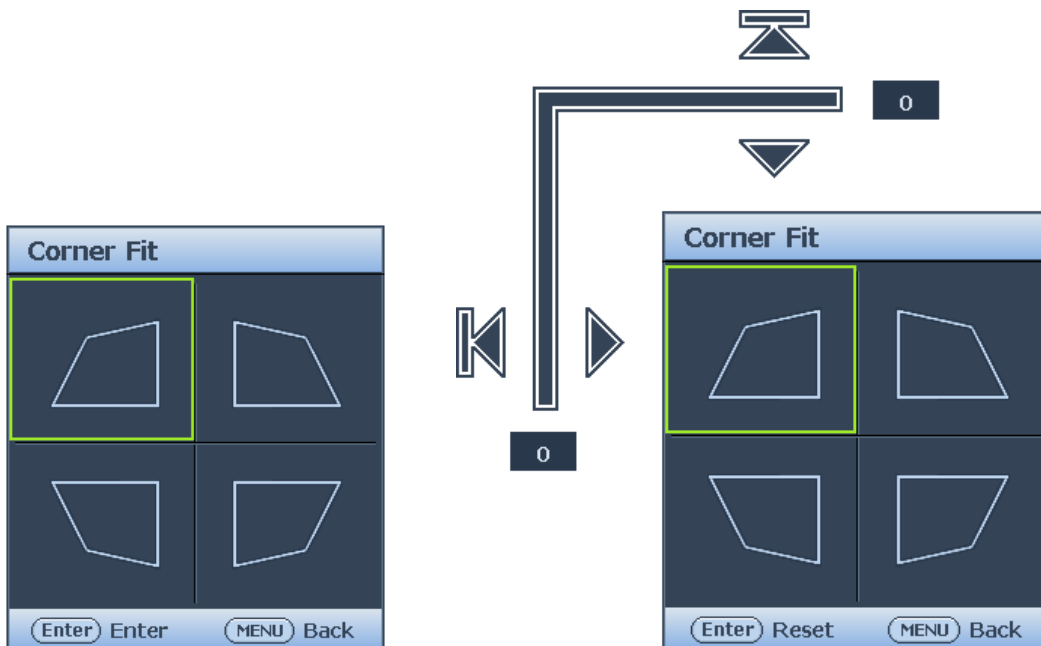

- **Top Left**  
Press **ENTER** and press ▲/▼/◀/▶ to correct the top left corner.
- **Top Right**  
Press **ENTER** and press ▲/▼/◀/▶ to correct the top right corner.
- **Bottom Left**  
Press **ENTER** and press ▲/▼/◀/▶ to correct the bottom left corner.
- **Bottom Right**  
Press **ENTER** and press ▲/▼/◀/▶ to correct the bottom right corner.

## Digital Image Resizing



- **Digital Zoom**  
Press **ENTER** and press ◀/▶ to reduce the image to a desired size. Press **AUTO SYNC** to restore the picture to its original size.
- **Digital Shrink**  
Press **ENTER** and press ◀/▶ to reduce the image to a desired size. Press **AUTO SYNC** to restore the picture to its original size.
- **Digital Image Shift**  
Press **ENTER** and press ▲/▼/◀/▶ to shift the image. Press **AUTO SYNC** to restore the picture to its original position.
- **Blanking**  
Press **ENTER** to enter the **Blanking** menu. See "[Blanking menu](#)" on page 45 for more details.

## Blanking menu



- **Top**  
Press ◀/▶ to adjust the top blanking area on the projected picture.
- **Bottom**  
Press ◀/▶ to adjust the bottom blanking area on the projected picture.
- **Left**  
Press ◀/▶ to adjust the left blanking area on the projected picture.
- **Right**  
Press ◀/▶ to adjust the right blanking area on the projected picture.
- **Reset**  
Press **ENTER** to set up all Blanking settings to default.

## Native Resolution



- **Display Resolution**  
Select the native resolution of this projector between **WUXGA** and **1080P**.
- **Digital Lens Shift**  
After the **Digital Lens Shift** page displays, press ▲/▼ to shift the projected image.

### **Note:**

This function is not available in the following situations: **Picture Moder** is **3D**; **Native Resolution** is **WUXGA**

## 3D menu

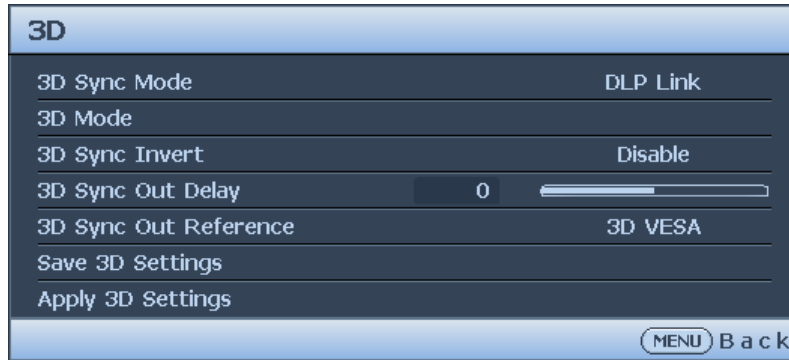

- **3D Sync Mode**  
Press ◀/▶ to select the 3D sync mode. The options are DLP Link and VESA 3D.
- **3D Mode**  
Press **ENTER** to enter the **3D Mode** menu. Press ▲/▼ to select the 3D format. The options are Auto, Top-Bottom, Frame Sequential, Frame Packing, Side-By-Side and Off.
- **3D Sync Invert**  
Press ◀/▶ to enable or disable 3D Sync Invert.
- **3D Sync Out Delay**  
Press ◀/▶ to adjust 3D sync out signal delay.
- **3D Sync Out Reference**  
Press ◀/▶ to select the 3D sync out behavior. The options are 3D VESA and Bypass to another projector.
- **Save 3D Settings**  
Press **ENTER** to enter the **Save 3D Settings** menu. Press ▲/▼ and **ENTER** to save the current 3D settings.
- **Apply 3D Settings**  
Press **ENTER** to enter the **Apply 3D Settings** menu. Press ▲/▼ and **ENTER** to apply the saved 3D settings.

## Fast Mode

Minimizing the response time (one frame) between the source input and the image output, this mode will enhance the controlling experience.

### When using **Fast Mode**:

- In order to have minimized response time, Keystone, Overscan, and Digital Lens Shift should be set at 0.
- Recommend timings are 1080P 60Hz/1080P 120Hz. See "[Timing table](#)" on page 75 for more details.

## Picture menu



- **Picture Mode**

Press ◀/▶ to select a picture mode. The options are Bright, Presentation, sRGB, Vivid, Cinema, DICOM SIM, 3D, HDR10, HLG, User 1 and User 2.

- **Bright mode:** Maximizes the brightness of the projected image. This mode is suitable for environments where extra-high brightness is required, such as using the projector in well lit rooms.
  - **Presentation mode:** Is designed for presentation. The brightness is emphasized in this mode to match PC and notebook coloring.
  - **sRGB mode:** Maximizes the purity of RGB colors to provide true-to-life images regardless of brightness setting. It is most suitable for viewing photos taken with an sRGB compatible and properly calibrated camera, and for viewing PC graphic and drawing applications such as AutoCAD.
  - **Infographic mode:** Is appropriate for playing colorful movies, video clips from digital cameras or DVs through the PC input for best viewing in a blackened (dimly lit) environment.
  - **Video mode:** Is appropriate for playing colorful movies, video clips from digital cameras or DVs through the PC input for best viewing in a blackened (dimly lit) environment.
  - **DICOM SIM:** This display mode simulates the grayscale/gamma performance of equipment used for “Digital Imaging and Communications in Medicine” (DICOM).  
**Important:** This mode should NEVER be used for medical diagnosis, it is for education/training purposes only.
  - **3D mode:** Is appropriate for playing 3D images and 3D video clips.
  - **HDR10 mode:** Only available when detecting HDR10 content, other picture mode can't be selected
  - **HLG mode:** Only available when detecting HLG content, other picture mode can't be selected
  - **User 1/User 2 mode:** Recalls the settings customized based on the current available picture modes.
  - **Reference Mode**
- Press ◀/▶ to select a reference mode. The options are Bright, Presentation, sRGB, Infographic, Video and DICOM SIM.

- **Brightness**

Press ◀/▶ to adjust the brightness of the projected image.

The higher the value, the brighter the image. And lower the setting, darker the image. Adjust this control so the black areas of the image appear just as black and that detail in the dark areas is visible.

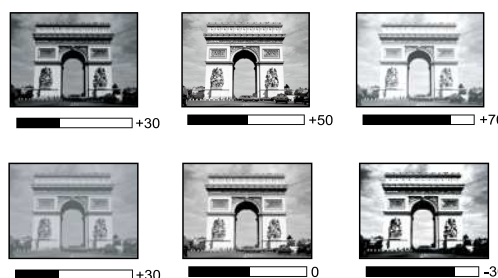

- **Contrast**

Press ◀/▶ to adjust the contrast of the projected image.

The higher the value, the greater the contrast. Use this to set the peak white level after you have previously adjusted the Brightness setting to suit your selected input and viewing environment.

- **Color**

Press ◀/▶ to adjust the color saturation.

Lower setting produces less saturated colors. If the setting is too high, colors on the image will be overpowering, which makes the image unrealistic.

- **Tint**

Press ◀/▶ to adjust the tint of the projected image.

The higher the value, the more reddish the picture becomes. The lower the value, the more greenish the picture becomes.

- **Sharpness**

Press ◀/▶ to adjust the display sharpness of the projected image.

The higher the value, the sharper the picture becomes. The lower the value, the softer the picture becomes.

- **Brilliant Color**

Press ◀/▶ to adjust the brilliant color of the projected image.

This feature utilizes a new color-processing algorithm and system level enhancements to enable higher brightness while providing truer, more vibrant colors in picture. It enables a greater than 50% brightness increase in mid-tone images, which are common in video and natural scenes, so the projector reproduces images in realistic and true colors. If you prefer images with that quality, select a desired level.

When **0** is selected, the **Color Temperature** function is not available.

- **Gamma Selection**

Press ◀/▶ to select the relationship between input source and picture brightness.

- **HDR Brightness**

Press ◀/▶ to adjust the HDR brightness.

- **Color Temperature**

Press ◀/▶ to adjust the color temperature. The options are Cool, Normal and Warm.

- **Warm:** Makes images appear reddish white.
- **Normal:** Maintains normal colorings for white.
- **Cool:** Makes the image appear bluish white.

- **Color Temperature Fine Tuning**

Press **ENTER** to enter the **Color Temperature Fine Tuning** menu. See "[Color Temperature Fine Tuning menu](#)" on page 49 for more details.



- **3D Color Management**

Press **ENTER** to enter the **3D Color Management** menu. See "[3D Color Management menu](#)" on page 50 for more details.

- **Reset Picture Settings**

Press **ENTER** to enter the **Reset Picture Settings** menu. Press **▲/▼** and press **ENTER** to set to the default value.

- **Current:** Returns current picture mode to the factory preset settings.
- **All:** Returns all settings, except User 1/User 2 in the Picture menu to the factory preset settings.

## Color Temperature Fine Tuning menu

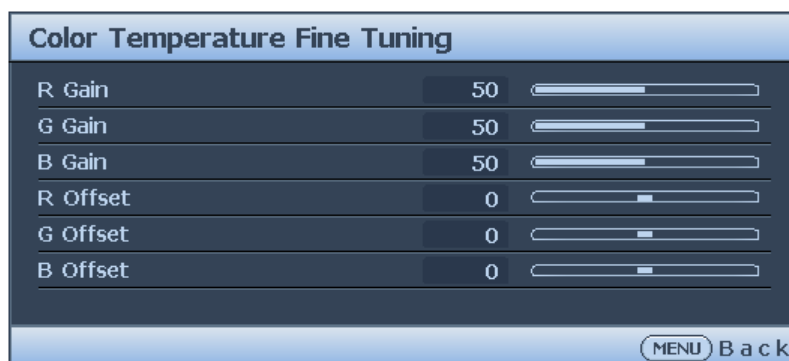

- **R Gain**

Press **◀/▶** to adjust the Red Gain.

- **G Gain**

Press **◀/▶** to adjust the Green Gain.

- **B Gain**

Press **◀/▶** to adjust the Blue Gain.

- **R Offset**

Press **◀/▶** to adjust the Red Offset.

- **G Offset**

Press **◀/▶** to adjust the Green Offset.

- **B Offset**

Press **◀/▶** to adjust the Blue Offset.

### To set a preferred color temperature:

1. Highlight **Color Temperature** and select **Warm**, **Normal** or **Cool** by pressing **◀/▶** on the projector or remote control.
2. Press **▼** to highlight **Color Temperature Fine Tuning** and press **ENTER**. The Color Temperature Fine Tuning page appears.
3. Press **▲/▼** to highlight the item you want to change and adjust the values by pressing **◀/▶**.
  - **R Gain/G Gain/B Gain:** Adjusts the contrast levels of Red, Green, and Blue.
  - **R Offset/G Offset/B Offset:** Adjusts the brightness levels of Red, Green, and Blue.
4. Press **MENU** to exit and save the settings.

## 3D Color Management menu

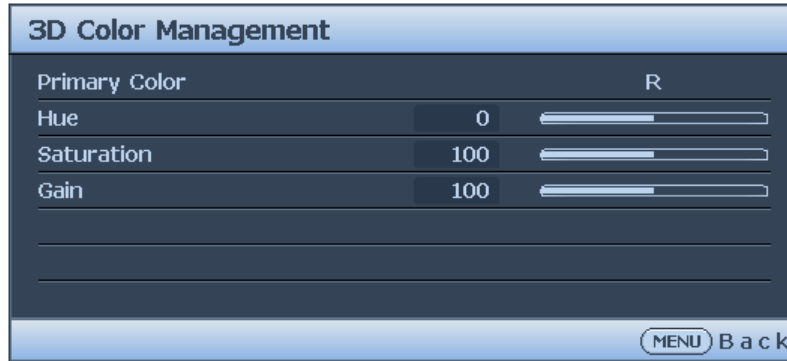

- Primary Color**  
 Press **ENTER** to enter the **Primary Color** menu. Press **▲/▼** to select the primary color. The options are R, G, B, C, M, Y, and W.  
 When **Primary Color** select R, G, B, C, Y and M, Adjusting Hue, Saturation and Gain.
- Hue**  
 Press **ENTER** to enter the **Hue** menu. Press **▲/▼/◀/▶** to adjust settings.
- Saturation**  
 Press **ENTER** to enter the **Saturation** menu. Press **▲/▼/◀/▶** to adjust settings.
- Gain**  
 Press **ENTER** to enter the **Gain** menu. Press **▲/▼/◀/▶** to adjust settings.  
 When Primary color Select White, Adjusting Red Gain/Green Gain/Blue Gain.

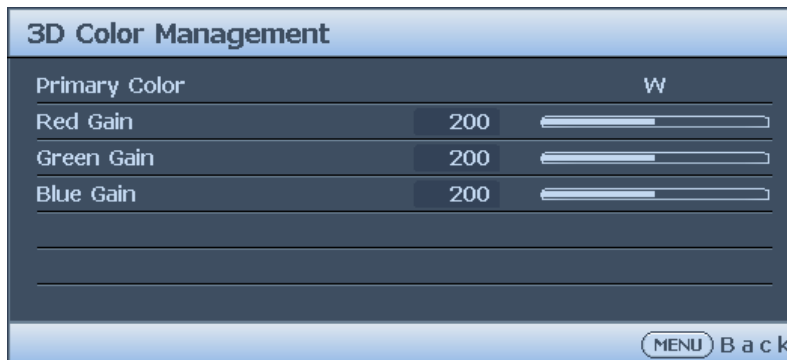

### 3D Color Management

In most installation situations, color management will not be necessary, such as in classroom, meeting room, or lounge room situations where lights remain on, or where building external windows allow daylight into the room.

Only in permanent installations with controlled lighting levels such as boardrooms, lecture theaters, or home theaters, should color management be considered. Color management provides fine color control adjustment to allow for more accurate color reproduction, should you require it.

Proper color management can only be achieved under controlled and reproducible viewing conditions. You will need to use a colorimeter (color light meter), and provide a set of suitable source images to measure color reproduction. These tools are not provided with the projector, however, your projector supplier should be able to provide you with suitable guidance, or even an experienced professional installer.

The Color Management provides seven sets (RGBCMYW) of colors to be adjusted. When you select each color, you can independently adjust its range and saturation according to your preference.

If you have purchased a test disc which contains various color test patterns and can be used to

test the color presentation on monitors, TVs, projectors, etc. You can project any image from the disc on the screen and enter the 3D Color Management menu to make adjustments.

To adjust the settings:

1. Go to the **Picture** menu and highlight **3D Color Management**.
2. Press **ENTER** and the 3D Color Management page displays.
3. Highlight **Primary color** and press **◀/▶** to select a color from among Red, Green, Blue, Cyan, Magenta, Yellow.
4. Press **▼** to highlight **Hue** and press **◀/▶** to select its range. Increase in the range will include colors consisted of more proportions of its two adjacent colors.  
Please refer to the illustration to the right for how the colors relate to each other.  
For example, if you select Red and set its range at 0, only pure red in the projected picture will be selected. Increasing its range will include red close to yellow and red close to magenta.
5. Press **▼** to highlight **Saturation** and adjust its values to your preference by press **◀/▶**. Every adjustment made will reflect to the image immediately.  
For example, if you select Red and set its value at 0, only the saturation of pure red will be affected.
6. Adjusting the **RGB Gain** to get an accurate white point. For example, if you want to correct a reddish white, you can decrease the R gain value. .

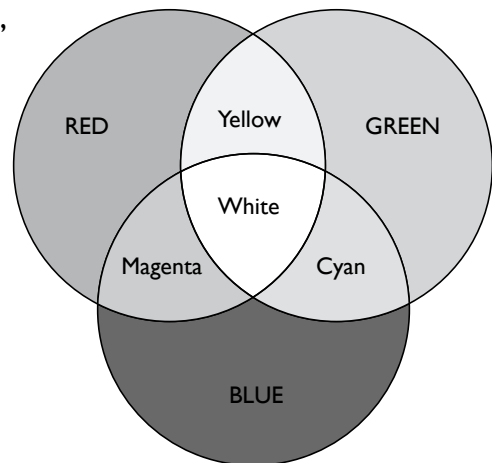

## Source menu



- **Quick Auto Search**  
Press **◀/▶** to enable or disable search the input source automatically.
- **HDR**  
Press **◀/▶** to select a suitable HDR setting. The options are Auto, SDR, HDR 10 and HLG.

- **HDMI Format**

Press ◀/▶ to select a suitable color format to optimize display quality. The options are Auto, RGB Limited, RGB Full, YUV Limited and YUV Full.

- **Auto:** Automatically selects a suitable color space and gray level for the incoming HDMI signal.
- **RGB Limited:** Utilizes the Limited range RGB 16-235.
- **RGB Full:** Utilizes the Full range RGB 0-255.
- **YUV Limited:** Utilizes the Limited range YUV 16-235.
- **YUV Full:** Utilizes the Full range YUV 0-255.

- **HDMI EDID**

Press **ENTER** to enter the **HDMI EDID** menu. Press ▲/▼ and press **ENTER** to select the HDMI. Press ◀/▶ to set to the default value.

- **Enhance:** Enhanced mode can switch to HDMI 2.0 EDID.
- **Standard:** Standard mode can switch to HDMI 1.4 EDID.

- **HDBaseT EDID**

Press ◀/▶ to switch HDBaseT EDID between HDMI 1.4 or HDMI 2.0 in order to solve compatibility issue with uncertain old players.

- **Enhance:** Enhanced mode can switch to HDMI 2.0 EDID.
- **Standard:** Standard mode can switch to HDMI 1.4 EDID.

- **HDMI Equalizer**

Press **ENTER** to enter the **HDMI Equalizer** menu. Press ▲/▼ and press **ENTER** to select the HDMI. Press ◀/▶ to set to the default value.

- **Auto Sync**

Press ◀/▶ to enable or disable auto sync function.

## System Setup : Basic menu



- Language**  
 Press **ENTER** to enter the **Language** menu. Press **▲/▼/◀/▶** to select the language of OSD menu.
- Projector Installation**  
 Press **◀/▶** to select the projector installation. The options are Front Table, Rear Table, Rear Ceiling and Front Ceiling.
- Menu Settings**  
 Press **ENTER** to enter the **Menu Settings** menu. See "[Menu Settings menu](#)" on page 54 for more details.
- Operation Settings**  
 Press **ENTER** to enter the **Operation Settings** menu. See "[Operation Settings menu](#)" on page 54 for more details.
- Lens Settings**  
 Press **ENTER** to enter the **Lens Settings** menu. See "[Lens Settings menu](#)" on page 55 for more details.
- Remote Receiver**  
 Press **◀/▶** to select the remote receiver. The options are Front, Rear and Front+Rear.
- Panel Key Lock**  
 Press **◀/▶** to enable or disable all panel key functions except **POWER** on the projector.
- Background Color**  
 Press **◀/▶** to select the background color when no input signal. The options are BenQ, Black, Blue, Purple and Gray.
- Splash Screen**  
 Press **◀/▶** to select the start up pattern when the projector turns on. The options are BenQ, Black and Blue.
- Projector ID Setting**  
 Press **◀/▶** to enable or disable the projector ID.

## Menu Settings menu



- **Menu Display Time**  
Press ◀/▶ to select the menu display time period. The options are 5 sec, 10 sec, 20 sec, 30 sec and Always.
- **Menu Position**  
Press ◀/▶ to select the menu display position. The options are Center, Top-Left, Top-Right, Bottom-Right and Bottom-Left.
- **Reminder Message**  
Press ◀/▶ to enable or disable reminder message displays.

## Operation Settings menu



- **Direct Power On**  
Press ◀/▶ to enable or disable automatically turning on the projector when the AC power is connected.
- **Signal Power On**  
Press ◀/▶ to enable or disable automatically turning on the projector when an input signal is detected.
- **Auto Power Off**  
Press ◀/▶ to enable or disable automatically turning off the projector when there is no input signal.
- **Blank Timer**  
Press ◀/▶ to set the length of time the image is blanked. The options are Disable, 5 mins, 10 mins, 15 mins, 20 mins, 25 mins and 30 mins.
- **Sleep Timer**  
Press ◀/▶ to set the length of time before the projector is turned off. The options are Disable, 30 mins, 1 hr, 2 hrs, 3 hrs, 4 hrs, 8 hrs and 12 hrs.
- **Filter Settings**  
Press **ENTER** to enter the **Filter Settings** menu. See "[Filter Settings menu](#)" on page 55 for more details.

## Filter Settings menu

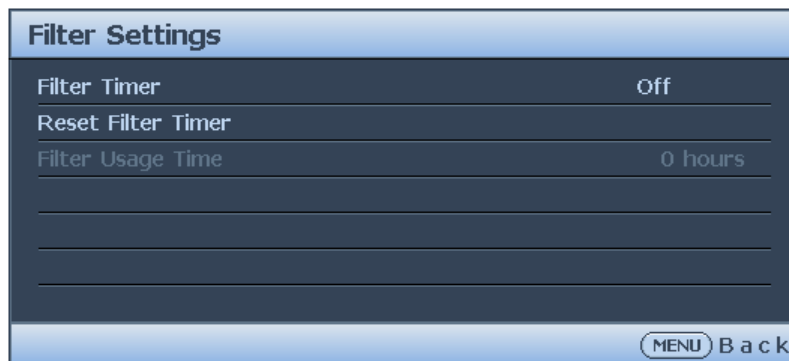

- **Filter Timer**  
Press ◀/▶ to enable or disable filter timer.
- **Reset Filter Timer**  
Press **ENTER** to reset the filter timer when the filter is replaced.
- **Filter Usage Time**  
Displays the current number of hours the filter has been used.

## Lens Settings menu

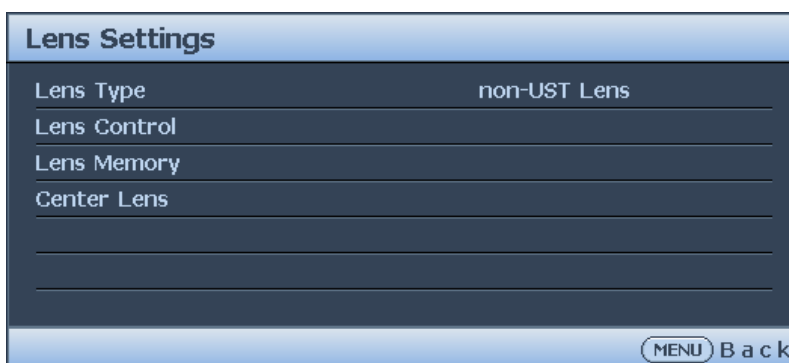

- **Lens Type**  
This projector can be used with 9 different projection lenses; the initial projection position of Ultra Short Throw (UST) Lens is different to other seven projection lenses. The projector preset two initial projection positions for these two types accordingly, Center Lens function can move the lens to the initial position (center) automatically per the setting. Please set this option to UST Lens if Ultra Short Throw Lens is installed in the projector, otherwise please set it to non-UST Lens.

### Note:

- There are two default positions, one is for regular zoom or fixed focus lens (Non-UST), the reference position is 0% of image width in horizontal shift and 0% of the image height in vertical shift; another one is for Ultra Short Throw Lens (UST), the default position is around 0% of image width in horizontal shift and 56% of image height in vertical shift. When performing Center Lens functions, projector will move the lens to the default position according to Lens type setting.
- If Ultra Short Throw Lens is installed and UST Lens is selected, you can perform Center Lens to move Lens to initial projection position automatically
- If using Ultra Short Throw Lens and setting to Non-UST Lens, the lens will be moved to the position which is lower than the default position of Ultra Short Throw Lens after performing Center Lens function, it causes the projected image is blocked by the top cover of the projector. In this case, please perform the Lens shift function to move up the Lens till the image can be projected normally.
- When using a zoom lens or a fixed-focus lens, if the lens shift range is limited and cannot be projected normally, make sure that the lens type is correctly setting as a non-UST lens, then perform the lens positioning function and then re-adjust the lens. Control and other functions to get the correct projection picture.

- **Lens Control**

Select this function to open Lens Control menu for adjustment of Zoom, Focus, or Shift. You can use the ENTER button to switch the Zoom / Focus or Shift menu. Use ▲ or ▼ to adjust zoom and vertical shift of the lens, or use ◀ ▶ to adjust focus and horizontal shift of the lens.

- **Lens Memory**

This projector supports Lens Memory function, Lens shift, Zoom and Focus memory can be stored in the projector up to 10 sets. You can load the stored memory setting to set up the lens automatically.

Select Lens memory 1~10 :

ENTER key to Save/Load. Press ▶ to switch Load/Reset state. CLEAR key to Reset.

- **Center Lens**

This is the lens calibration function, the projector calibrates the lens shift, focus and zoom parameters for the precise lens memory function. After performing this function, the lens will be moved to the center position as factory default setting.

**Note:**

- There are two default center positions for UST (Ultra Short Throw) Lens and non-UST Lens, make sure Lens Type setting is correct before performing this function.
- If an UST lens is installed, remove the support kit of the UST lens before performing Center Lens. After all the settings of the lens control are completed, then replace the support kit to fix the UST lens.



## System Setup :Advanced menu

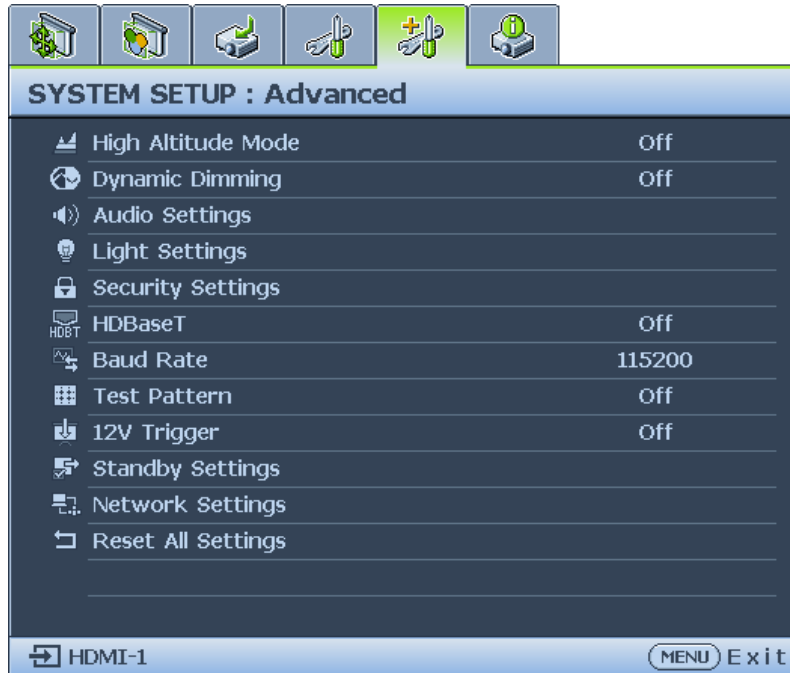

- High Altitude Mode**  
 Press ◀/▶ to enable or disable High Altitude Mode. Enable this function when the operating altitude is higher than 1500m or the ambient temperature is over 40°C.
- Dynamic Dimming**  
 Press ◀/▶ to enable or disable dynamic dimming function. Enable the function to automatically reduces the screen's brightness level when the displayed image contains a high proportion of bright areas.  
 When **3D Sync Mode** is **DLP Link**, the **Dynamic Dimming** function is not available.
- Audio Settings**  
 Press **ENTER** to enter the **Audio Settings** menu. See "[Audio Settings menu](#)" on page 59 for more details.
- Light Settings**  
 Press **ENTER** to enter the **Light Settings** menu. See "[Light Settings menu](#)" on page 60 for more details.
- Security Settings**  
 Press **ENTER** to enter the **Security Settings** menu. See "[Security Settings menu](#)" on page 60 for more details.
- HDBaseT**  
 Press ◀/▶ to enable or disable the HDBaseT.

### Note:

- Turn on HDBaseT mode will disable internal LAN and RS232 control and switch to Normal power standby mode automatically.
- When high altitude mode on, power force to 85%.

HDBaseT control function table

Control Side	Function	Standby Mode			Remark
		Eco (< 0.5W)	Network (<2W)	Normal (>2W)	
Projector	Front-IR (Wireless)	○	○	○ (Can disable by OSD)	
	Rear-IR (Wireless)	○	○	○ (Can disable by OSD)	
	RS-232	○	○	×	
	RJ45/LAN	×	○	×	
	Wired Remote	○	○	○	
HDBaseT TX Box	HDBT-IR (Wireless)	×	×	○	
	RS-232	×	×	○	
	RJ45/LAN	×	×	○	
	Wired Remote	×	×	○	User can connect wired remote at HDBaseT TX side to get the wired function.

○: Enable      ×: Disable

- **Baud Rate**  
Press ◀/▶ to select RS-232 baud rate. The options are 2400, 4800, 9600, 14400, 19200, 38400, 57600 and 1152000.
- **Test Pattern**  
Press ◀/▶ to select the test pattern. The options are Off, Grid, White, Red, Green, Blue, Black, RGB Ramps, Color Bar, Step Bars, CheckBoard, Horizontal Lines, Vertical Lines, Diagonal Lines, Horizontal Ramp and Vertical Ramps.
- **I2V Trigger**  
Press ◀/▶ to enable or disable I2V trigger function.
- **Standby Settings**  
Press **ENTER** to enter the **Standby Settings** menu. See "[Standby Settings menu](#)" on [page 61](#) for more details.
- **Network Settings**  
Press **ENTER** to enter the **Network Settings** menu. See "[Network Settings menu](#)" on [page 61](#) for more details.
- **Reset All Settings**  
Press **ENTER** to reset all settings to default value.

## Audio Settings menu

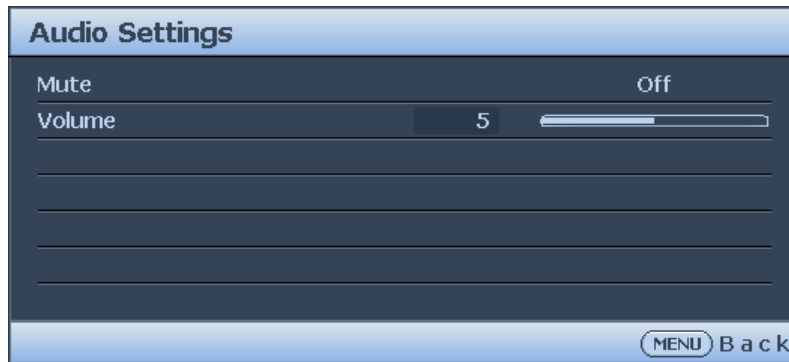

- **Mute**

Press ◀/▶ to enable or disable the mute function.

- Using the remote control

Press **MUTE** to temporarily turn off the sound. While the sound is off, the screen will display in the upper right corner of the screen.

To restore the sound, press **MUTE** again.

- Using the OSD menu

1. Press **MENU** and then press ◀/▶ until the **System Setup: Advanced** menu is highlighted.
2. Press ▼ to highlight **Audio Settings** and press **ENTER**. The Audio Settings page displays.
3. Highlight **Mute** and press ◀/▶ to select **On**.
4. To restore the sound, repeat steps 1-3 and press ◀/▶ to select **Off**.

- **Volume**

Press ◀/▶ to adjust the volume of the projector.

- Using the remote control

Press **VOLUME+/VOLUME-** to select a desired sound level.

- Using the OSD menu

1. Press **MENU** and then press ◀/▶ until the **System Setup: Advanced** menu is highlighted.
2. Press ▼ to highlight **Audio Settings** and press **ENTER**. The Audio Settings page displays.
3. Press ▼ to highlight **Volume** and press ◀/▶ to select a desired sound level.

## Light Settings menu



- **Light Mode**  
Press ◀/▶ to select the light mode. The options are Normal, Economic, Dimming and Custom.
- **Custom Brightness**  
Press ◀/▶ to adjust the brightness of the projector.
- **Constant Brightness**  
Press ◀/▶ to enable or disable the function to maintain the brightness at the same level.
- **Light Usage Time**  
Press **ENTER** to enter the **Light Source Information** menu.

## Security Settings menu

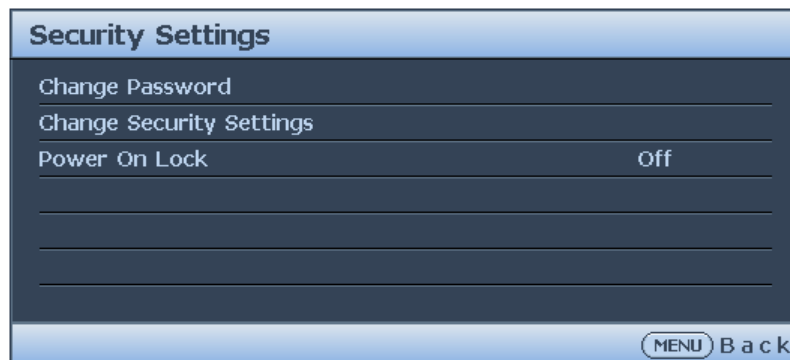

- **Change Password**  
Press **ENTER** to change the password.
- **Change Security Settings**  
Press **ENTER** to change the security settings.
- **Power On Lock**  
Press ◀/▶ to enable or disable the power on lock function. If the function is enabled, you must enter the password every time the projector is turned on.

## Standby Settings menu

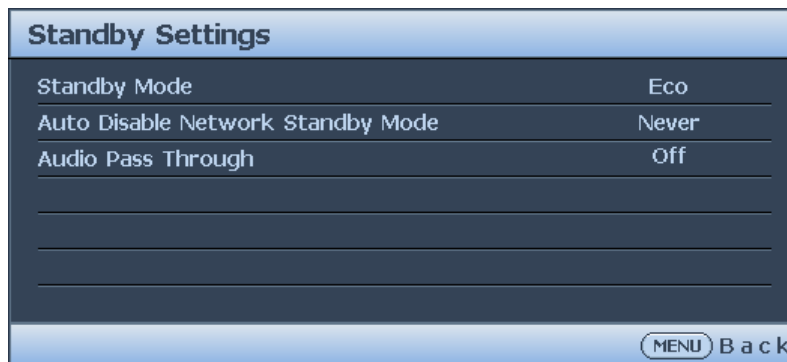

- **Standby Mode**  
Press ◀/▶ to select the standby mode. The options are Eco, Network and Normal.
- **Auto Disable Network Standby Mode**  
Press ◀/▶ to enable or disable the auto switch from network standby mode to non-network standby mode after a period of time.
- **Audio Pass Through**  
Press ◀/▶ to enable the audio line-out function when the projector is in standby mode. The options are Audio In, HDMI 1, HDMI 2, HDBaseT and Off.

## Network Settings menu



- **Wired LAN**  
Press **ENTER** to enter the **Wired LAN** menu to setup the IP address, subnet mask, default gateway, DNS server and DHCP.
- **AMX Device Discovery**  
Press ◀/▶ to enable or disable the AMX device discovery function. When the function is enabled, the projector can be detected by an AMX controller.
- **Mac Address**  
Displays the current MAC address of the projector.

## Information menu

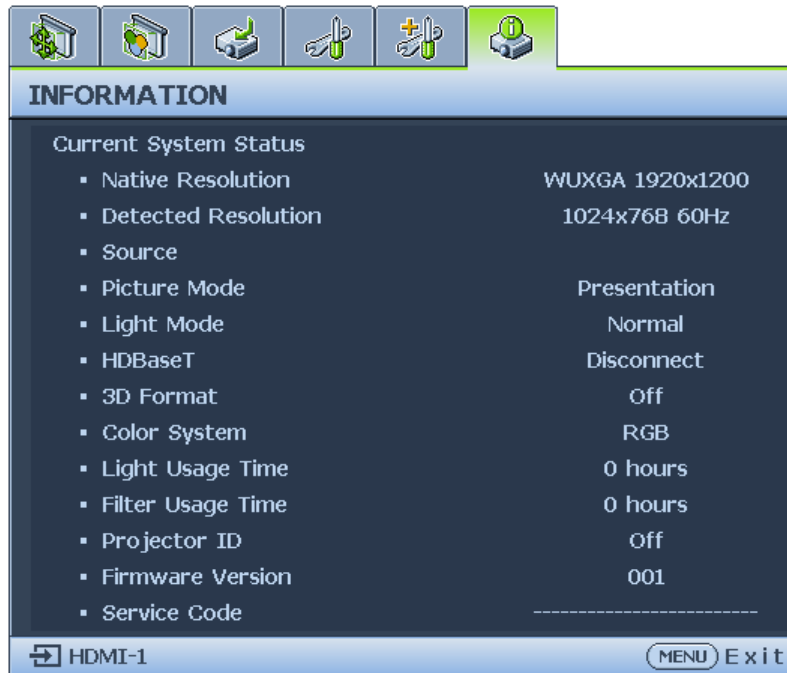

- **Native Resolution**  
Displays the native resolution of the model.
- **Detected Resolution**  
Displays the detected timing.
- **Source**  
Displays the current signal source.
- **Picture Mode**  
Displays the current picture mode.
- **Light Mode**  
Displays the current light mode.
- **HDBaseT**  
Displays the current HDBaseT status.
- **3D Format**  
Displays the current 3D mode. Only available when 3D Mode is enabled.
- **Color System**  
Displays the input system format.
- **Light Usage Time**  
Displays the number of hours the light has been used.
- **Filter Usage Time**  
Displays the number of hours the filter has been used.
- **Projector ID**  
Displays the current projector ID.
- **Firmware Version**  
Displays the firmware version of your projector.
- **Service Code**  
Displays the serial number of your projector.

## Menu structure

Main menu	Sub-menu	Options	
Display	Wall Color	Off / Light Yellow / Pink / Light Green / Blue / Blackboard	
	Aspect Ratio	Auto/ Real/ 4:3/ 16:9/ 16:10/ 2.35:1	
	2D Keystone		
	Corner Fit	Top Left/ Top Right/ Bottom Left/ Bottom Right	
	Position		
	Phase		
	H.size		
	Digital Image Resizing	Digital Zoom	PC: 1.0X~2.0X Video: 1.0X~1.8X
		Digital Shrink	0.8X~1.0X
		Digital Image Shift	
		Blanking	Top/ Bottom/ Left/ Right/ Reset
	Native Resolution	Display Resolution	WUXGA / 1080P
		Digital Lens Shift	
	Overscan		Composite/S-Video: 0- 3 others: 0-3
	3D	3D Sync Mode	DLP Link/VESA 3D
		3D Mode	Auto/ Frame Sequential/ Frame Packing/ Top-Bottom/ Side-By-Side/ Off
			3D Sync Invert
		3D Sync Out Delay	
		3D Sync Out Reference	3D VESA/ Bypass
		Save 3D Settings	3D Settings 1/ 3D Settings 2/ 3D Settings 3
		Apply 3D Settings	3D Settings 1/ 3D Settings 2/ 3D Settings 3/ Off
	Fast Mode	On / Off	

Main menu	Sub-menu	Options	
Picture	Picture Mode	Bright/ Presentation/ sRGB/ Infographic/ Video/ DICOM SIM/ (3D)/ (HDR10)/ (HLG)/ User 1/ User 2	
	Reference Mode	Bright/ Presentation/ sRGB/ Infographic/ Video/ DICOM SIM/ 3D/ HDR10/ HLG	
	Brightness		
	Contrast		
	Color		
	Tint		
	Sharpness		
	Brilliant Color		
	Gamma Selection	1.8/ 2.0/ 2.1/ 2.2/ 2.3/ 2.4/ 2.6/ DICOM/ BenQ	
	HDR Brightness	-2/ -1/ 0/ 1/ 2	
	Color Temperature	Warm/ Normal/ Cool	
	Color Temperature Fine Tuning	R Gain/ G Gain/ B Gain/ R Offset/ G Offset/ B Offset	
	3D Color Management	Primary Color	R/ G/ B/ C/ M/ Y/ W
		Hue	
Saturation			
	Gain		
	Reset Picture Settings	Current/ All/ Cancel	
Source	Quick Auto Search	On/ Off	
	HDR	Auto / SDR / HDR 10 / HLG	
	HDMI Format	Auto/ RGB Limited/ RGB Full/ YUV Limited/ YUV Full	
	HDMI EDID	HDMI	Enhanced/ Standard
		HDMI-1	Enhanced/ Standard
		HDMI-2	Enhanced/ Standard
	HDBaseT EDID	Enhanced/ Standard	
	HDMI Equalizer	HDMI	Auto/ Lower/ Low/ Middle/ High/ Higher
		HDMI-1	Auto/ Lower/ Low/ Middle/ High/ Higher
		HDMI-2	Auto/ Lower/ Low/ Middle/ High/ Higher
Auto Sync	On/ Off		



Main menu	Sub-menu	Options
System Setup: Basic	Language	English / Français / Deutsch / Italiano / Español / Русский / 繁體中文 / 简体中文 / 日本語 / 한국어 / Svenska / Nederlands / Türkçe / Čeština / Português / తెలుగు / Polski / Magyar / Hrvatski / Română / Norsk / Dansk / Български / Suomi / Indonesian / Ελληνικά / العربية / हिन्दी
	Projector Installation	Front Table/ Rear Table/ Rear Ceiling/ Front Ceiling
	Menu Settings	Menu Display Time 5 sec/ 10 sec/ 20 sec/ 30 sec/ Always
		Menu Position Center/ Top-Left/ Top-Right/ Bottom-Right/ Bottom-Left
	Operation Settings	Reminder Message On/ Off
		Direct Power On On/ Off
		Signal Power On Computer: On/ Off HDMI-I: On/ Off
		Auto Power Off Disable/ 3 mins/ 10 mins/ 15 mins/ 20 mins/ 25 mins/ 30 mins
		Blank Timer Disable/ 5 mins/ 10 mins/ 15 mins/ 20 mins/ 25 mins/ 30 mins
		Sleep Timer Disable/ 30 mins/ 1 hr/ 2 hrs/ 3 hrs/ 4 hrs/ 8 hrs/ 12 hrs
		Filter Settings Filter Timer: On/ Off Reset Filter Timer: Reset/ Cancel Filter Usage Time
	Lens Settings	Lens Type Non-UST Lens / UST Lens
		Lens Control Zoom & Focus Lens Shift
		Lens Memory Save Memory: Memory1 / Memory2 / Memory3 / Memory4 / Memory5 / Memory6 / Memory7 / Memory8 / Memory9 / Memory10 Load Memory: Memory1 / Memory2 / Memory3 / Memory4 / Memory5 / Memory6 / Memory7 / Memory8 / Memory9 / Memory10
		Center Lens
	Remote Receiver	Front+Rear/ Front/ Rear
	Panel Key Lock	On/ Off
	Background Color	BenQ/ Black/ Blue/ Purple/ Gray
	Splash Screen	BenQ/ Black/ Blue
	Projector ID Setting	Off/ 01~99

Main menu	Sub-menu	Options
System Setup: Advanced	High Altitude Mode	On/ Off
	Dynamic Dimming	On/ Off
	Audio Settings	Mute Volume
		On/ Off
Light Settings	Light Mode	Normal / ECO/ Dimming/ Custom
	Custom Brightness	
	Constant Brightness	On / Off
	Light Usage Time	Light Usage Time/ Normal Mode/ ECO Mode/ Dimming Mode/ Custom Mode
Security Settings	Change Password	
	Change Security Settings	
	Power On Lock	On/ Off
HDBaseT		On/ Off
Baud Rate		2400/ 4800/ 9600/ 14400/ 19200/ 38400/ 57600/ 115200
Test Pattern		Off/ Grid/ White/ Red/ Green/ Blue/ Black/ RGB Ramps/ Color Bar/ Step Bars/ CheckBoard/ Horizontal Lines/ Vertical Lines/ Diagonal Lines/ Horizontal Ramp/ Vertical Ramps
I2V Trigger		On/ Off
Standby Settings	Standby Mode	Eco/ Network/ Normal
	Auto Disable Network Standby Mode	Never/ 20 min/ 1 hr/ 3 hr/ 6 hr
	Audio Pass Through	Audio In/ HDMI 1/ HDMI 2/ HDBaseT/ Off
Network Settings	Wired LAN	Status
		DHCP
		IP Address
		Subnet Mask
		Default Gateway
		DNS Server
		Apply
	AMX Device Discovery	On/ Off
Mac Address		
Reset All Settings		Reset/ Cancel

<b>Main menu</b>	<b>Sub-menu</b>	<b>Options</b>
Information	Current System Status	Native Resolution WUXGA 1920x1200 1080p 1920x1080
		Detected Resolution
		Source
		Picture Mode
		Light Mode
		HDBaseT Connect / Disconnect
		3D Format
		Color System
		Light Usage Time
		Filter Usage Time Appears when Filter Timer On
		Projector ID
		Firmware Version
		Service Code SN

# Maintenance

## Before maintaining the projector

- Make sure to turn off the power before maintaining the projector.
- When switching off the projector, make sure to follow the procedures in "[Switch off the projector](#)" on page 40.

## Care of the projector

Your projector needs little maintenance. The only thing you need to do on a regular basis is to keep the lens clean.

Never remove any parts of the projector. Contact your dealer if other parts need replacing.

## Clean the lens front surface

Clean the lens whenever you notice dirt or dust on the surface.

- Use a canister of compressed air to remove dust.
- If there is dirt or smears, use lens-cleaning paper or moisten a soft cloth with lens cleaner and gently wipe the lens surface.

### **Caution:**

Never use any type of abrasive pad, alkaline/acid cleaner, scouring powder, or volatile solvent, such as alcohol, benzene, thinner or insecticide. Using such materials or maintaining prolonged contact with rubber or vinyl materials may result in damage to the projector surface and cabinet material.

## Clean the projector case

Before you clean the case, turn the projector off using the proper shutdown procedure as described in "[Switch off the projector](#)" on page 40 and unplug the power cord.

- To remove dirt or dust, wipe the case with a soft, lint-free cloth.
- To remove stubborn dirt or stains, moisten a soft cloth with water and a neutral pH detergent. Then wipe the case.

### **Caution:**

Never use wax, alcohol, benzene, thinner or other chemical detergents. These can damage the case.

## LED indicator

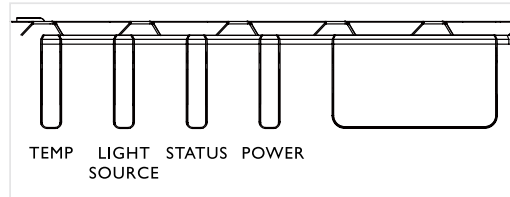

## System message

SYSTEM STATUS	POWER LED	STATUS LED	LIGHT SOURCE LED	TEMP LED
Lamp Ready	ON	OFF	OFF	OFF
Start	Flashing	OFF	OFF	OFF
Cooling	Flashing	OFF	OFF	OFF
Over Temperature T1	OFF	OFF	1 blinks	ON
Over Temperature T2	OFF	OFF	2 blinks	ON
Over Temperature T3	OFF	OFF	3 blinks	ON
Over Temperature T4	OFF	OFF	4 blinks	ON
Over Temperature T5	OFF	OFF	5 blinks	ON
Thermal Break Sensor error	OFF	4 blinks	OFF	OFF
Air Filter Warning	ON	ON	OFF	OFF
FAN1 error	OFF	6 blinks	1 blinks	OFF
FAN2 error	OFF	6 blinks	2 blinks	OFF
FAN3 error	OFF	6 blinks	3 blinks	OFF
FAN4 error	OFF	6 blinks	4 blinks	OFF
FAN5 error	OFF	6 blinks	5 blinks	OFF
FAN6 error	OFF	6 blinks	6 blinks	OFF
FAN7 error	OFF	6 blinks	7 blinks	OFF
FAN8 error	OFF	6 blinks	8 blinks	OFF
FAN9 error	OFF	6 blinks	9 blinks	OFF
FAN10 error	OFF	6 blinks	10 blinks	OFF
FAN11 error	OFF	6 blinks	11 blinks	OFF
FAN12 error	OFF	6 blinks	12 blinks	OFF
FAN13 error	OFF	6 blinks	13 blinks	OFF
IW MCU detects scaler stops working	OFF	2 blinks	OFF	OFF
Case Open	OFF	7 blinks	OFF	OFF
Lens Open	OFF	7 blinks	1 blinks	OFF
DMD error	OFF	8 blinks	OFF	OFF
Color wheel error	OFF	9 blinks	OFF	OFF

<b>SYSTEM STATUS</b>	<b>POWER LED</b>	<b>STATUS LED</b>	<b>LIGHT SOURCE LED</b>	<b>TEMP LED</b>
Phosphor wheel error	OFF	9 blinks	1 blinks	OFF
Laser Driver board Color wheel speed too low	OFF	4 blinks	2 blinks	OFF
Laser Driver board Phosphor wheel speed too low	OFF	4 blinks	3 blinks	OFF
Laser Driver board 54V error	OFF	4 blinks	4 blinks	OFF
Laser Driver board over temp	OFF	4 blinks	5 blinks	OFF
Laser Driver board SCI error	OFF	4 blinks	6 blinks	OFF
Laser Driver board initial fail	OFF	4 blinks	7 blinks	OFF
Laser Driver board lit fail	OFF	4 blinks	8 blinks	OFF

# Troubleshooting

## Troubleshooting

The projector does not turn on.

Cause	Remedy
There is no power from the power cable.	Plug the power cord into the AC inlet on the projector, and plug the power cord into the power outlet. If the power outlet has a switch, make sure that it is switched on.
Attempting to turn the projector on again during the cooling process.	Wait until the cooling down process has completed.

No picture.

Cause	Remedy
The video source is not turned on or connected correctly.	Turn the video source on and check that the signal cable is connected correctly.
The projector is not correctly connected to the input signal device.	Check the connection.
The input signal has not been correctly selected.	Select the correct input signal with the SOURCE key on the projector or remote control.

Blurred image.

Cause	Remedy
The projection lens is not correctly focused.	Adjust the focus of the lens using the focus ring.
The projector and the screen are not aligned properly.	Adjust the projection angle and direction as well as the height of the unit if necessary.
The lens cover is still closed.	Open the lens cover.

Remote control does not work.

Cause	Remedy
The battery is out of power.	Replace the battery with new one.
There is an obstacle between the remote control and the projector.	Remove the obstacle.
You are too far away from the projector.	Stand within 7 meters (23 feet) of the projector.

The password is incorrect.

Cause	Remedy
You do not remember the password.	<ol style="list-style-type: none"> <li>1. Press and hold <b>AUTO</b> on the projector or remote control for 3 seconds. The projector will display a coded number on the screen.</li> <li>2. Write down the number and turn off your projector.</li> <li>3. Seek help from the local BenQ service center to decode the number. You may be required to provide proof of purchase documentation to verify that you are an authorized user of the projector.</li> </ol>

# Specifications

## Specifications

### Optical

#### Resolution

LU9750/LU9800  
1920 x 1200

#### Display system

Single-chip DLP™ system

#### Lens F/Number

STANDARD LSISDA  
F=2.02 to 2.40, f=22.84 to 28.61mm  
SHORT THROW LSIST3A  
F=2.1 to 2.6, f=11.45 to 16.32mm  
WIDE ZOOM 1 LSISTIA  
F=2.05 to 2.27, f=16.64 to 19.54mm  
SEMI LONG LSILT0  
F=2.5 to 3.1, f=28.5 to 42.75mm  
WIDE ZOOM 2 LSIST2A  
F=2 to 2.44, f=18.65 to 23.85mm  
SEMI LONG 2 LSILT1  
F=1.86 to 2.48, f=32.9 to 54.2mm  
LONG 1 LSILT2  
F=1.85 to 2.41, f=52.8 to 79.1mm  
LONG 2 LSILT3  
F=1.85 to 2.48, f=78.564 to 121.9mm  
ULTRA SHORT THROW LSIST4  
F=2, f=5.64mm

#### Light source

Laser Package

### Electrical

#### Power supply

AC100-240V  
50/60 Hz (Automatic)  
LU9750: 9.0A  
LU9800: 11.0A

#### Power consumption

LU9750: 792W(typ);0.5W(standby)  
LU9800: 893W(typ);0.5W(standby)

### Control

#### USB

Type-B x 1

#### RS-232 serial control

9 pin x 2 (In / Out)

#### IR receiver x 2

#### 12V TRIGGER

12VDC (Max. 0.2 A) x 1

#### LAN control

RJ45 x 1 (10/100Mbps)

#### Wired Remote

PC audio jack x 2 (In / Out)

### Input terminals

#### Computer input

##### RGB input

3D Sync in x 1

D-Sub 15-pin (female) x 1

BNC x 5

##### Digital input

DVI-D x 1

#### Video signal input

##### COMPONENT

D-Sub 15-pin (female) x 1

BNC x 5

##### SD/HDTV signal input

Digital - HDMI x 1

HDMI 2 x 1

RJ45 x1 (HDBaseT)

#### Audio signal input

##### Audio in

PC audio jack x 1



## Specifications

### Mechanical

#### Weight

LU9750: 26.4kg

LU9800: 26.8kg

#### Dimension

587.3 x 216 x 500 mm (23.12"x8.50"x19.69")

### Output terminals

#### Audio signal output

RCA R/L jack x 1

#### Monitor Out

D-Sub 15-pin (female) x1

#### USB

TYPE-A (5V/2A)

3D SYNC OUT x 1

### Environmental Requirements

#### Operating temperature

0°C–40°C at sea level (>35°C, power force to 80%)

#### Operating relative humidity

10%–90% (without condensation)

#### Operating altitude

0–1499 m at 0°C–35°C

1500–3000 m at 0°C–30°C (with High Altitude

Mode on and power force to 85%)

#### Storage temperature

-20°C–60°C

#### Storage humidity

10%–90% RH (without condensation)



### Note:

All specifications are subject to change without notice.

# Dimensions

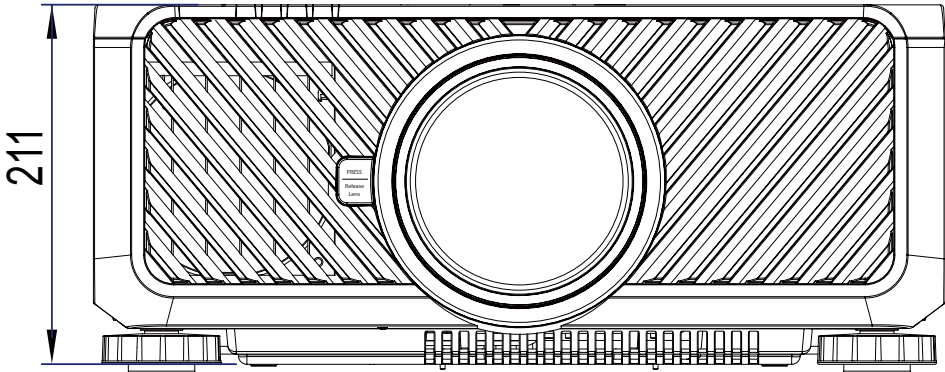
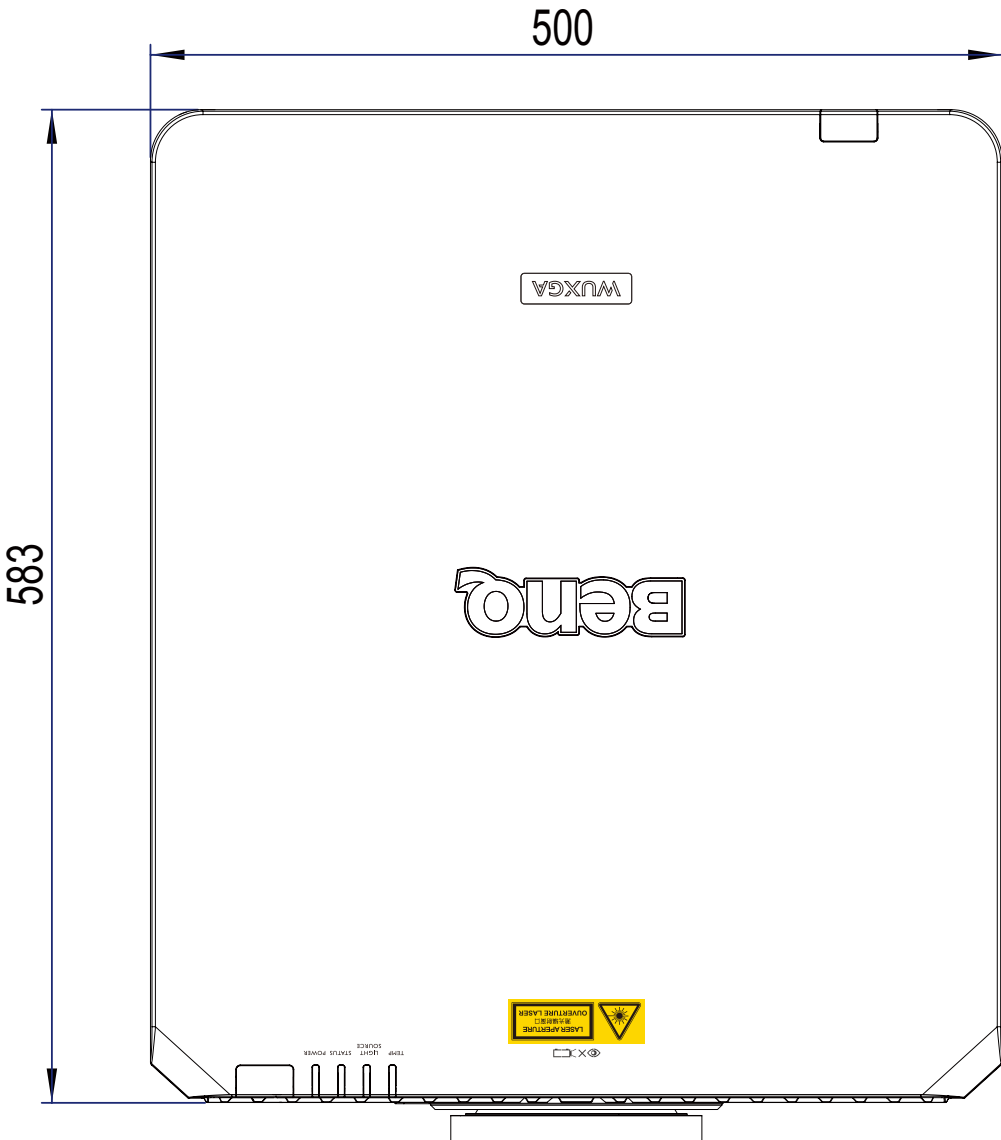

# Appendix

## Timing table

### HDMI Input (Support Video Timings)

Timing	Resolution	Horizontal frequency (KHz)	Vertical frequency (Hz)	Dot Clock Frequency (MHz)	User Manual Supported	3D Field	3D frame packing	3D over-under	3D side-by-side
480i	720(1440) x 480	15.73	59.94	27	Yes	⊙			
480p	720 x 480	31.47	59.94	27	Yes	⊙			
576i	720(1440) x 576	15.63	50	27	Yes				
576p	720 x 576	31.25	50	27	Yes				
720/50p	1280 x 720	37.5	50	74.25	Yes		⊙	⊙	⊙
720/60p	1280 x 720	45	60	74.25	Yes	⊙	⊙	⊙	⊙
1080/24P	1920 x 1080	27	24	74.25	Yes		⊙	⊙	⊙
1080/25P	1920 x 1080	28.13	25	74.25	Yes				
1080/30P	1920 x 1080	33.75	30	74.25	Yes				
1080/50i	1920 x 1080	28.13	50	74.25	Yes				⊙
1080/60i	1920 x 1080	33.75	60	74.25	Yes				⊙
1080/50P	1920 x 1080	56.25	50	148.5	Yes			⊙	⊙
1080/60P	1920 x 1080	67.5	60	148.5	Yes			⊙	⊙
2160/24P	3840 x 2160	54	24	297	Yes				
2160/25P	3840 x 2160	56.25	25	297	Yes				
2160/30P	3840 x 2160	67.5	30	297	Yes				
2160/50P	3840 x 2160	112.5	50	594	Yes				
2160/60P	3840 x 2160	135	60	594	Yes				

### HDMI Input (Support PC Timings)

Resolution	Mode	Refresh rate (Hz)	Horizontal frequency (KHz)	Clock (MHz)	User Manual Supported	3D Field Sequential	3D over-under	3D side-by-side
640 x 480	VGA_60	59.94	31.469	25.175	Yes	⊙	⊙	⊙
	VGA_72	72.809	37.861	31.5	Yes			
	VGA_75	75	37.5	31.5	Yes			
	VGA_85	85.008	43.269	36	Yes			
	VGA_120**	119.518	61.91	52.5	Yes			
720 x 400	720x400_70	70.087	31.469	28.3221	Yes			
800 x 600	SVGA_60	60.317	37.879	40	Yes	⊙	⊙	⊙
	SVGA_72	72.188	48.077	50	Yes			
	SVGA_75	75	46.875	49.5	Yes			
	SVGA_85	85.061	53.674	56.25	Yes			
	SVGA_120 (Reduce Blanking)	119.854	77.425	83	Yes	⊙		
1024 x 768	XGA_60	60.004	48.363	65	Yes	⊙	⊙	⊙
	XGA_70	70.069	56.476	75	Yes			
	XGA_75	75.029	60.023	78.75	Yes			
	XGA_85	84.997	68.667	94.5	Yes			
	XGA_120 (Reduce Blanking)	119.989	97.551	115.5	Yes	⊙		
1152 x 864	1152 x 864_75	75	67.5	108	Yes			
1024x576	BenQ Notebook Timing	60	35.82	46.996	Yes			

Resolution	Mode	Refresh rate (Hz)	Horizontal frequency (KHz)	Clock (MHz)	User Manual Supported	3D Field Sequential	3D over-under	3D side-by-side
1024x600	BenQ Notebook Timing	64.995	41.467	51.419	Yes			
1280x720	1280 x 720_60	60	45	74.25	Yes	⊙	⊙	⊙
	1280x720_120	120	90	148.5	No	⊙		
1280 x 768	1280 x 768_60 (Reduce Blanking)	60	47.396	68.25	No	⊙	⊙	⊙
	1280 x 768_60	59.87	47.776	79.5	Yes	⊙	⊙	⊙
1280 x 800	WXGA_60	59.81	49.702	83.5	Yes	⊙	⊙	⊙
	WXGA_75	74.934	62.795	106.5	Yes			
	WXGA_85	84.88	71.554	122.5	Yes			
	WXGA_120 (Reduce Blanking)	119.909	101.563	146.25	Yes	⊙		
1280 x 1024	SXGA_60	60.02	63.981	108	Yes		⊙	⊙
	SXGA_75	75.025	79.976	135	Yes			
	SXGA_85	85.024	91.146	157.5	Yes			
1280 x 960	1280 x 960_60	60	60	108	Yes		⊙	⊙
	1280 x 960_85	85.002	85.938	148.5	Yes			
1360 x 768	1360 x 768_60	60.015	47.712	85.5	Yes		⊙	⊙
1440 x 900	WXGA+_60 (Reduce Blanking)	60	55.469	88.75	No		⊙	⊙
	WXGA+_60	59.887	55.935	106.5	Yes		⊙	⊙
1400X1050	SXGA+_60	59.978	65.317	121.75	Yes		⊙	⊙
1600x1200	UXGA	60	75	162	Yes		⊙	
1680x1050	1680x1050_60 (Reduce Blanking)	59.883	64.674	119	No		⊙	⊙
	1680x1050_60	59.954	65.29	146.25	Yes		⊙	⊙
640x480 @67Hz	MAC13	66.667	35	30.24	Yes			
832x624 @75Hz	MAC16	74.546	49.722	57.28	Yes			
1024x768 @75Hz	MAC19	75.02	60.241	80	Yes			
1152x870 @75Hz	MAC21	75.06	68.68	100	Yes			
1920x1080 @60HZ	1920X1080_60 (Reduce Blanking)	60	67.5	148.5	Yes	⊙	⊙	⊙
1920x1200 @60HZ	1920X1200_60 (Reduce Blanking)	59.95	74.038	154	Yes	⊙	⊙	⊙
1920X1080 (VESA)	1920X1080_60 (for Auditorium model)	59.963	67.158	173	no			
1920x1080 @120Hz	1920X1080_120	120	135	297	Yes			
1920x1200 @120Hz	1920X1200_120 (Reduce Blanking)	119.909	152.404	317	Yes			
3840x2160	3840X2160_30 (Reduce Blanking)	29.97	65.66	257.404	Yes			
3840x2160	3840X2160_60 (Reduce Blanking)	59.94	133.187	522.092	Yes			
3840x2160	3840X2160_30	30	67.5	297	Yes			
3840x2160	3840X2160_60	60	135	594	Yes			

## PC Input(Support PC Timings)

Resolution	Mode	Refresh rate (Hz)	Horizontal frequency (KHz)	Clock (MHz)	User Manual Supported	3D Field Sequential	3D over-under	3D side-by-side
720 x 400	720x400_70	70.087	31.469	28.3221	Yes			
640 x 480	VGA_60	59.94	31.469	25.175	Yes	⊙	⊙	⊙
	VGA_72	72.809	37.861	31.5	Yes			
	VGA_75	75	37.5	31.5	Yes			
	VGA_85	85.008	43.269	36	Yes			

Resolution	Mode	Refresh rate (Hz)	Horizontal frequency (KHz)	Clock (MHz)	User Manual Supported	3D Field Sequential	3D over-under	3D side-by-side
800 x 600	SVGA_60	60.317	37.879	40	Yes	⊙	⊙	⊙
	SVGA_72	72.188	48.077	50	Yes			
	SVGA_75	75	46.875	49.5	Yes			
	SVGA_85	85.061	53.674	56.25	Yes			
	SVGA_120 (Reduce Blanking)	119.854	77.425	83	Yes	⊙		
1024 x 768	XGA_60	60.004	48.363	65	Yes	⊙	⊙	⊙
	XGA_70	70.069	56.476	75	Yes			
	XGA_75	75.029	60.023	78.75	Yes			
	XGA_85	84.997	68.667	94.5	Yes			
	XGA_120 (Reduce Blanking)	119.989	97.551	115.5	Yes	⊙		
1152 x 864	1152 x 864_75	75	67.5	108	Yes			
1024 x 576	BenQ NB Timing	60	35.82	46.966	Yes			
1024 x 600	BenQ NB Timing	64.995	41.467	51.419	Yes			
1280x720	1280 x 720_60	60	45	74.25	Yes	⊙	⊙	⊙
	1280x720_120	120	90	148.5	No	⊙		
1280 x 768	1280 x 768_60 (Reduce Blanking)	60	47.396	68.25	No	⊙	⊙	⊙
	1280 x 768_60	59.87	47.776	79.5	Yes	⊙	⊙	⊙
1280 x 800	WXGA_60	59.81	49.702	83.5	Yes	⊙	⊙	⊙
	WXGA_75	74.934	62.795	106.5	Yes			
	WXGA_85	84.88	71.554	122.5	Yes			
	WXGA_120 (Reduce Blanking)	119.909	101.563	146.25	Yes	⊙		
1280 x 1024	SXGA_60	60.02	63.981	108	Yes		⊙	⊙
	SXGA_75	75.025	79.976	135	Yes			
	SXGA_85	85.024	91.146	157.5	Yes			
1280 x 960	1280 x 960_60	60	60	108	Yes		⊙	⊙
	1280 x 960_85	85.002	85.938	148.5	Yes			
1360 x 768	1360 x 768_60	60.015	47.712	85.5	Yes		⊙	⊙
1440 x 900	WXGA+_60 (Reduce Blanking)	60	55.469	88.75	No		⊙	⊙
	WXGA+_60	59.887	55.935	106.5	Yes		⊙	⊙
1400x1050	SXGA+_60	59.978	65.317	121.75	Yes		⊙	⊙
1600x1200	UXGA	60	75	162	Yes		⊙	⊙
1680 x 1050	1680x1050_60 (Reduce Blanking)	59.883	64.674	119	No		⊙	⊙
	1680x1050_60	59.954	65.29	146.25	Yes		⊙	⊙
640x480 @67Hz	MAC13	66.667	35	30.24	Yes			
832x624 @75Hz	MAC16	74.546	49.722	57.28	Yes			
1024x768 @75Hz	MAC19	74.93	60.241	80	Yes			
1152x870 @75Hz	MAC21	75.06	68.68	100	Yes			
1920x1080 @60HZ	1920X1080_60 (Reduce Blanking)	60	67.5	148.5	Yes	⊙	⊙	⊙
1920x1200 @60HZ	1920X1200_60 (Reduce Blanking)	59.95	74.038	154	Yes	⊙	⊙	⊙
1920X1080 (VESA)	1920X1080_60 (for Auditorium model)	59.963	67.158	173	no			
1920X1080 (VESA)	1920X1080_60 (for Auditorium model)	59.963	67.158	173	no			

## True 3D Video Compatibility table

Input Resolutions	HDMI I.4a 3D Input	Input Timing		
		1280 X 720P @ 50Hz	Top - and - Bottom	
		1280 X 720P @ 60Hz	Top - and - Bottom	
		1280 X 720P @ 50Hz	Frame packing	
		1280 X 720P @ 60Hz	Frame packing	
		1920 X 1080i @50 Hz	Side- by-Side (Half)	
		1920 X 1080i @60 Hz	Side- by-Side (Half)	
		1920 X 1080P @24 Hz	Top - and - Bottom	
		1920 X 1080P @24 Hz	Frame packing	
	HDMI I.3	1920 x 1080i @ 50Hz	Side-by-Side (Half)	SBS mode is on
		1920 x 1080i @ 60Hz		
		1280 x 720P @50Hz		
		1280 x 720P @60Hz		
		1920 x 1080i @ 50Hz	Top-and-Bottom	TAB mode is on
		1920 x 1080i @ 60Hz		
		1280 x 720P @50Hz		
		1280 x 720P @60Hz		
	480i	HQFS	3D format is Frame sequential	

 **Note:**

3D glasses must be supported to 144Hz.

## RS232 command control

Function	Type	Operation	ASCII
Power	Write	Power On	<CR>*pow=on#<CR>
	Write	Power Off	<CR>*pow=off#<CR>
	Read	Power Status	<CR>*pow=?#<CR>
Source Selection	Write	COMPUTER/YPbPr	<CR>*sour=RGB#<CR>
	Write	COMPUTER 2/YPbPr2	<CR>*sour=RGB2#<CR>
	Write	DVI-D	<CR>*sour=dvid#<CR>
	Write	HDMI(MHL)	<CR>*sour=hdmi#<CR>
	Write	HDMI 2(MHL2)	<CR>*sour=hdmi2#<CR>
	Write	HDBaseT	<CR>*sour=hdbaset#<CR>
	Read	Current source	<CR>*sour=?#<CR>
Audio Control	Write	Mute On	<CR>*mute=on#<CR>
	Write	Mute Off	<CR>*mute=off#<CR>
	Read	Mute Status	<CR>*mute=?#<CR>
	Write	Volume +	<CR>*vol=+#<CR>
	Write	Volume -	<CR>*vol=-#<CR>
	Write	Volume level for customer	<CR>*vol=value#<CR>
	Read	Volume Status	<CR>*vol=?#<CR>
Audio source select	Write	Audio pass Through off	<CR>*audiosour=off#<CR>
	Write	Audio-Computer I	<CR>*audiosour=RGB#<CR>
	Write	Audio-HDMI	<CR>*audiosour=hdmi#<CR>
	Write	Audio-HDMI2	<CR>*audiosour=hdmi2#<CR>
	Write	HDBaseT	<CR>*audiosour=hdbaset#<CR>
	Read	Audio pass Status	<CR>*audiosour=?#<CR>
Picture Mode	Write	Presentation	<CR>*appmod=preset#<CR>
	Write	sRGB	<CR>*appmod=srgb#<CR>
	Write	Bright	<CR>*appmod=bright#<CR>
	Write	DICOM	<CR>*appmod=dicom#<CR>
	Write	Video	<CR>*appmod=video#<CR>
	Write	Infographic	<CR>*appmod=infographic#<CR>
	Write	User1	<CR>*appmod=user1#<CR>
	Write	User2	<CR>*appmod=user2#<CR>
	Write	3D	<CR>*appmod=threed#<CR>
	Write	HDR10	<CR>*appmod=hdr#<CR>
	Write	HLG	<CR>*appmod=hlg#<CR>
	Read	Picture Mode	<CR>*appmod=?#<CR>
	Write	Contrast +	<CR>*con=+#<CR>
	Write	Contrast -	<CR>*con=-#<CR>

Function	Type	Operation	ASCII
Picture Setting	Write	Set Contrast value	<CR>*con=value#<CR>
	Read	Contrast value	<CR>*con=?#<CR>
	Write	Brightness +	<CR>*bri=+#<CR>
	Write	Brightness -	<CR>*bri=-#<CR>
	Write	Set Brightness value	<CR>*bri=value#<CR>
	Read	Brightness value	<CR>*bri=?#<CR>
	Write	Color +	<CR>*color=+#<CR>
	Write	Color -	<CR>*color=-#<CR>
	Write	Set Color value	<CR>*color=value#<CR>
	Read	Color value	<CR>*color=?#<CR>
	Write	Sharpness +	<CR>*sharp=+#<CR>
	Write	Sharpness -	<CR>*sharp=-#<CR>
	Write	Set Sharpness value	<CR>*sharp=value#<CR>
	Read	Sharpness value	<CR>*sharp=?#<CR>
	Write	Color Temperature-Warm	<CR>*ct=warm#<CR>
	Write	Color Temperature-Normal	<CR>*ct=normal#<CR>
	Write	Color Temperature-Cool	<CR>*ct=cool#<CR>
	Read	Color Temperature Status	<CR>*ct=?#<CR>
	Write	Aspect 4:3	<CR>*asp=4:3#<CR>
	Write	Aspect 16:9	<CR>*asp=16:9#<CR>
	Write	Aspect 16:10	<CR>*asp=16:10#<CR>
	Write	Aspect 2.35:1	<CR>*asp=2.35#<CR>
	Write	Aspect Auto	<CR>*asp=AUTO#<CR>
	Write	Aspect Real	<CR>*asp=REAL#<CR>
	Read	Aspect Status	<CR>*asp=?#<CR>
	Write	Vertical Keystone +	<CR>*vkeystone=+#<CR>
	Write	Vertical Keystone -	<CR>*vkeystone=-#<CR>
	Write	Set Vertical Keystone value	<CR>*vkeystone=value#<CR>
	Read	Vertical Keystone value	<CR>*vkeystone=?#<CR>
	Write	Horizontal Keystone +	<CR>*hkeystone=+#<CR>
	Write	Horizontal Keystone -	<CR>*hkeystone=-#<CR>
	Write	Set Horizontal Keystone value	<CR>*hkeystone=value#<CR>
	Read	Horizontal Keystone value	<CR>*hkeystone=?#<CR>
	Write	Overscan Adjustment +	<CR>*overscan=+#<CR>
	Write	Overscan Adjustment -	<CR>*overscan=-#<CR>
	Read	Overscan Adjustment value	<CR>*overscan=?#<CR>
	Write	4 Corners Top-Left-X Decrease	<CR>*cornerfittlx=-#<CR>
	Write	4 Corners Top-Left-X Increase	<CR>*cornerfittlx=+#<CR>
	Read	4 Corners Top-Left-X Status	<CR>*cornerfittlx=?#<CR>



Function	Type	Operation	ASCII
Picture Setting	Write	4 Corners Top-Left-Y Decrease	<CR>*cornerfittly=-#<CR>
	Write	4 Corners Top-Left-Y Increase	<CR>*cornerfittly=+#<CR>
	Read	4 Corners Top-Left-Y Status	<CR>*cornerfittly=?#<CR>
	Write	4 Corners Top-Right-X Decrease	<CR>*cornerfittrx=-#<CR>
	Write	4 Corners Top-Right-X Increase	<CR>*cornerfittrx=+#<CR>
	Read	4 Corners Top-Right-X Status	<CR>*cornerfittrx=?#<CR>
	Write	4 Corners Top-Right-Y Decrease	<CR>*cornerfittry=-#<CR>
	Write	4 Corners Top-Right-Y Increase	<CR>*cornerfittry=+#<CR>
	Read	4 Corners Top-Right-Y Status	<CR>*cornerfittry=?#<CR>
	Write	4 Corners Bottom-Left-X Decrease	<CR>*cornerfitblx=-#<CR>
	Write	4 Corners Bottom-Left-X Increase	<CR>*cornerfitblx=+#<CR>
	Read	4 Corners Bottom-Left-X Status	<CR>*cornerfitblx=?#<CR>
	Write	4 Corners Bottom-Left-Y Decrease	<CR>*cornerfitbly=-#<CR>
	Write	4 Corners Bottom-Left-Y Increase	<CR>*cornerfitbly=+#<CR>
	Read	4 Corners Bottom-Left-Y Status	<CR>*cornerfitbly=?#<CR>
	Write	4 Corners Bottom-Right-X Decrease	<CR>*cornerfitbrx=-#<CR>
	Write	4 Corners Bottom-Right-X Increase	<CR>*cornerfitbrx=+#<CR>
	Read	4 Corners Bottom-Right-X Status	<CR>*cornerfitbrx=?#<CR>
	Write	4 Corners Bottom-Right-Y Decrease	<CR>*cornerfitbry=-#<CR>
	Write	4 Corners Bottom-Right-Y Increase	<CR>*cornerfitbry=+#<CR>
	Read	4 Corners Bottom-Right-Y Status	<CR>*cornerfitbry=?#<CR>
	Write	Digital Zoom In	<CR>*zoomI#<CR>
	Write	Digital Zoom out	<CR>*zoomO#<CR>
	Write	Auto	<CR>*auto#<CR>
	Write	Brilliant color +	<CR>*BC=+#<CR>
	Write	Brilliant color -	<CR>*BC=-#<CR>
	Write	Brilliant color set value	<CR>*BC=value#<CR>
	Read	Brilliant color status	<CR>*BC=?#<CR>
	Write	Auto(HDR)	<CR>*hdr=auto#<CR>
	Write	SDR	<CR>*hdr=sdr#<CR>
	Write	HDR10	<CR>*hdr=hdr#<CR>
	Write	HLG	<CR>*hdr=hlg#<CR>
Read	HDR status	<CR>*hdr=?#<CR>	
Write	Reset current picture settings	<CR>*rstcurpicsetting#<CR>	
Write	Reset all picture settings	<CR>*rstallpicsetting#<CR>	
Operation Settings	Write	Projector Position-Front Table	<CR>*pp=FT#<CR>
	Write	Projector Position-Rear Table	<CR>*pp=RE#<CR>
	Write	Projector Position-Rear Ceiling	<CR>*pp=RC#<CR>

Function	Type	Operation	ASCII
Operation Settings	Write	Projector Position-Front Ceiling	<CR>*pp=FC#<CR>
	Read	Projector Position Status	<CR>*pp=?#<CR>
	Write	Quick auto search	<CR>*QAS=on#<CR>
	Write	Quick auto search	<CR>*QAS=off#<CR>
	Read	Quick auto search status	<CR>*QAS=?#<CR>
	Write	Menu Position - Center	<CR>*menuposition=center#<CR>
	Write	Menu Position - Top-Left	<CR>*menuposition=tl#<CR>
	Write	Menu Position - Top-Right	<CR>*menuposition=tr#<CR>
	Write	Menu Position - Bottom-Right	<CR>*menuposition=br#<CR>
	Write	Menu Position - Bottom-Left	<CR>*menuposition=bl#<CR>
	Read	Menu Position Status	<CR>*menuposition=?#<CR>
	Write	Direct Power On-on	<CR>*directpower=on#<CR>
	Write	Direct Power On-off	<CR>*directpower=off#<CR>
	Read	Direct Power On-Status	<CR>*directpower=?#<CR>
	Write	Signal Power On-on	<CR>*autopower=on#<CR>
	Write	Signal Power On-off	<CR>*autopower=off#<CR>
	Read	Signal Power On-Status	<CR>*autopower=?#<CR>
	Baud Rate	Write	2400
Write		4800	<CR>*baud=4800#<CR>
Write		9600	<CR>*baud=9600#<CR>
Write		14400	<CR>*baud=14400#<CR>
Write		19200	<CR>*baud=19200#<CR>
Write		38400	<CR>*baud=38400#<CR>
Write		57600	<CR>*baud=57600#<CR>
Write		115200	<CR>*baud=115200#<CR>
Read		Current Baud Rate	<CR>*baud=?#<CR>
Lamp Control	Read	Lamp Hour	<CR>*ltim=?#<CR>
	Write	Normal mode	<CR>*lampm=lnor#<CR>
	Write	Eco mode	<CR>*lampm=eco#<CR>
	Write	Dimming mode	<CR>*lampm=dimming#<CR>
	Write	Custom mode	<CR>*lampm=custom#<CR>
	Write	Light level for custom mode	<CR>*lampcustom=value#<CR>
	Read	Light level status for custom mode	<CR>*lampcustom=?#<CR>
	Read	Lamp Mode Status	<CR>*lampm=?#<CR>
Miscellaneous	Read	Model Name	<CR>*modelname=?#<CR>
	Read	System F/W Version	<CR>*sysfwversion=?#<CR>
	Read	Scaler F/W Version	<CR>*scalerfwversion=?#<CR>
	Read	Lan F/W Version	<CR>*lanfwversion=?#<CR>
	Read	MCU F/W Version	<CR>*mcfwversion=?#<CR>

Function	Type	Operation	ASCII
Miscellaneous	Write	Blank On	<CR>*blank=on#<CR>
	Write	Blank Off	<CR>*blank=off#<CR>
	Read	Blank Status	<CR>*blank=?#<CR>
	Write	Freeze On	<CR>*freeze=on#<CR>
	Write	Freeze Off	<CR>*freeze=off#<CR>
	Read	Freeze Status	<CR>*freeze=?#<CR>
	Write	Menu On	<CR>*menu=on#<CR>
	Write	Menu Off	<CR>*menu=off#<CR>
	Read	Menu Status	<CR>*menu=?#<CR>
	Write	Up	<CR>*up#<CR>
	Write	Down	<CR>*down#<CR>
	Write	Right	<CR>*right#<CR>
	Write	Left	<CR>*left#<CR>
	Write	Enter	<CR>*enter#<CR>
	Write	Back	<CR>*back#<CR>
	Write	Source Menu On	<CR>*sourmenu=on#<CR>
	Write	Source Menu Off	<CR>*sourmenu=off#<CR>
	Read	Source Menu Status	<CR>*sourmenu=?#<CR>
	Write	3D Sync Off	<CR>*3d=off#<CR>
	Write	3D Auto	<CR>*3d=auto#<CR>
	Write	3D Sync Top Bottom	<CR>*3d=tb#<CR>
	Write	3D Sync Frame Sequential	<CR>*3d=fs#<CR>
	Write	3D Frame packing	<CR>*3d=fp#<CR>
	Write	3D Side by side	<CR>*3d=sbs#<CR>
	Write	3D inverter disable	<CR>*3d=da#<CR>
	Write	3D inverter	<CR>*3d=iv#<CR>
	Write	3D nVIDIA	<CR>*3d=nvidia#<CR>
	Read	3D Sync Status	<CR>*3d=?#<CR>
	Write	Remote Receiver-front+rear	<CR>*rr=fr#<CR>
	Write	Remote Receiver-front	<CR>*rr=f#<CR>
	Write	Remote Receiver-rear	<CR>*rr=r#<CR>
	Read	Remote Receiver Status	<CR>*rr=?#<CR>
	Write	AMX Device Discovery-on	<CR>*amxdd=on#<CR>
	Write	AMX Device Discovery-off	<CR>*amxdd=off#<CR>
	Read	AMX Device Discovery Status	<CR>*amxdd=?#<CR>
	Read	Mac Address	<CR>*macaddr=?#<CR>
	Read	Serial Number	<CR>*serialnumber=?#<CR>
	Write	High Altitude mode on	<CR>*Highaltitude=on#<CR>
	Write	High Altitude mode off	<CR>*Highaltitude=off#<CR>

Function	Type	Operation	ASCII
Miscellaneous	Read	High Altitude mode status	<CR>*Highaltitude=?#<CR>
Installation	Write	Load Lens memory 1	<CR>*lensload=m1#<CR>
	Write	Load Lens memory 2	<CR>*lensload=m2#<CR>
	Write	Load Lens memory 3	<CR>*lensload=m3#<CR>
	Write	Load Lens memory 4	<CR>*lensload=m4#<CR>
	Write	Load Lens memory 5	<CR>*lensload=m5#<CR>
	Write	Load Lens memory 6	<CR>*lensload=m6#<CR>
	Write	Load Lens memory 7	<CR>*lensload=m7#<CR>
	Write	Load Lens memory 8	<CR>*lensload=m8#<CR>
	Write	Load Lens memory 9	<CR>*lensload=m9#<CR>
	Write	Load Lens memory 10	<CR>*lensload=m10#<CR>
	Read	Read Lens memory status	<CR>*lensload=?#<CR>
	Write	save Lens memory 1	<CR>*lenssave=m1#<CR>
	Write	save Lens memory 2	<CR>*lenssave=m2#<CR>
	Write	save Lens memory 3	<CR>*lenssave=m3#<CR>
	Write	save Lens memory 4	<CR>*lenssave=m4#<CR>
	Write	save Lens memory 5	<CR>*lenssave=m5#<CR>
	Write	save Lens memory 6	<CR>*lenssave=m6#<CR>
	Write	save Lens memory 7	<CR>*lenssave=m7#<CR>
	Write	save Lens memory 8	<CR>*lenssave=m8#<CR>
	Write	save Lens memory 9	<CR>*lenssave=m9#<CR>
Write	save Lens memory 10	<CR>*lenssave=m10#<CR>	
Write	Reset Lens to center	<CR>*lensreset=center#<CR>	
Color Calibration	Write	Tint +	<CR>*tint=+#<CR>
	Write	Tint -	<CR>*tint=-#<CR>
	Write	Set Tint value	<CR>*tint=value#<CR>
	Read	Get Tint value	<CR>*tint=?#<CR>
	Write	Set gamma value	<CR>*gamma=value#<CR>
	Read	Gamma value status	<CR>*gamma=?#<CR>
	Write	Set HDR Brightness value	<CR>*hdrbri=value#<CR>
	Read	Get HDR Brightness value	<CR>*hdrbri=?#<CR>
	Write	Red Gain +	<CR>*RGain=+#<CR>
	Write	Red Gain -	<CR>*RGain=-#<CR>
	Write	Set Red Gain value	<CR>*RGain=value#<CR>
	Read	Get Red Gain value	<CR>*RGain=?#<CR>
	Write	Green Gain +	<CR>*GGain=+#<CR>
	Write	Green Gain -	<CR>*GGain=-#<CR>
Write	Set Green Gain value	<CR>*GGain=value#<CR>	

Function	Type	Operation	ASCII
Color Calibration	Read	Get Green Gain value	<CR>*GGain=?#<CR>
	Write	Blue Gain +	<CR>*BGain=+#<CR>
	Write	Blue Gain -	<CR>*BGain=-#<CR>
	Write	Set Blue Gain value	<CR>*BGain=value#<CR>
	Read	Get Blue Gain value	<CR>*BGain=?#<CR>
	Write	Red Offset +	<CR>*ROffset=+#<CR>
	Write	Red Offset -	<CR>*ROffset=-#<CR>
	Write	Set Red Offset value	<CR>*ROffset=value#<CR>
	Read	Get Red Offset value	<CR>*ROffset=?#<CR>
	Write	Green Offset +	<CR>*GOffset=+#<CR>
	Write	Green Offset -	<CR>*GOffset=-#<CR>
	Write	Set Green Offset value	<CR>*GOffset=value#<CR>
	Read	Get Green Offset value	<CR>*GOffset=?#<CR>
	Write	Blue Offset +	<CR>*BOffset=+#<CR>
	Write	Blue Offset -	<CR>*BOffset=-#<CR>
	Write	Set Blue Offset value	<CR>*BOffset=value#<CR>
	Read	Get Blue Offset value	<CR>*BOffset=?#<CR>
	Write	Primary Color	<CR>*primcr=value#<CR>
	Read	Primary Color Status	<CR>*primcr=?#<CR>
	Write	Hue +	<CR>*hue=+#<CR>
	Write	Hue -	<CR>*hue=-#<CR>
	Write	Set Hue value	<CR>*hue=value#<CR>
	Read	Get Hue value	<CR>*hue=?#<CR>
	Write	Saturation +	<CR>*saturation=+#<CR>
	Write	Saturation -	<CR>*saturation=-#<CR>
	Write	Set Saturation value	<CR>*saturation=value#<CR>
	Read	Get Saturation value	<CR>*saturation=?#<CR>
	Write	Gain +	<CR>*gain=+#<CR>
	Write	Gain -	<CR>*gain=-#<CR>
	Write	Set Gain value	<CR>*gain=value#<CR>
Read	Get Gain value	<CR>*gain=?#<CR>	
Service	Read	Error Code report	<CR>*error=report#<CR>
	Read	FAN 1 speed	<CR>*fan1=?#<CR>
	Read	FAN 2 speed	<CR>*fan2=?#<CR>
	Read	FAN 3 speed	<CR>*fan3=?#<CR>
	Read	FAN 4 speed	<CR>*fan4=?#<CR>
	Read	FAN 5 speed	<CR>*fan5=?#<CR>
	Read	FAN 6 speed	<CR>*fan6=?#<CR>
	Read	FAN 7 speed	<CR>*fan7=?#<CR>

Function	Type	Operation	ASCII
Service	Read	FAN 8 speed	<CR>*fan8=?#<CR>
	Read	FAN 9 speed	<CR>*fan9=?#<CR>
	Read	FAN 10 speed	<CR>*fan10=?#<CR>
	Read	FAN 11 speed	<CR>*fan11=?#<CR>
	Read	FAN 12 speed	<CR>*fan12=?#<CR>
	Read	FAN 13 speed	<CR>*fan13=?#<CR>
	Read	Temperature 1	<CR>*tmp1=?#<CR>
	Read	Temperature 2	<CR>*tmp2=?#<CR>
	Read	Temperature 3	<CR>*tmp3=?#<CR>
	Read	Temperature 4	<CR>*tmp4=?#<CR>
	Read	Temperature 5	<CR>*tmp5=?#<CR>
	Read	LED indicator	<CR>*led=?#<CR>

## PJLink

### PJLink protocol

The network function of this projector support the PJLink class I, and the PJLink protocol can be used to perform projector setting and projector status query operations from a computer.

### Control commands

The following table lists the PJLink protocol commands that can be used to control the projector.

- x characters in table are non-specific characters.

Command	Control Details	Parameter/ Return String	Remark		
POWR	Power supply control	0 1	Standby Power on		
POWR?	Power supply status query	0 1	Standby Power on		
INPT	Input selection	11	PCI / YPbPr1		
INPT?	Input status query	12	PC2 / YPbPr2		
		21	VIDEO		
		31	HDMI1		
		32	HDMI2		
		33	DVI-D		
		34	HDBaseT		
AVMT	Mute	11	Video mute On		
AVMT?	Mute query	10	Video mute Off		
		21	Audio mute On		
		20	Audio mute Off		
		31	Video & Audio mute On		
		30	Video & Audio mute Off		
ERST?	Error status query	xxxxxx	1st byte	Indicates fan errors, and returns 0 - 2	0 = No error is detected 1 = Warning 2 = Error
			2nd byte	Indicates light source errors, and returns 0 - 2	
			3rd byte	Indicates temperature errors, and returns 0 - 2	
			4th byte	Return 0	
			5th byte	Return 0	
			6th byte	Indicates other errors, and returns 0 - 2	
LAMP?	Light source status query	xxxxxxxxxxxx	1st number (1-5 digitals): Light source 1 runtime		
INST?	Input selection list query	11 12 21 31 32 33 34	LU9750/LU9800		

Command	Control Details	Parameter/ Return String	Remark
NAME?	Projector name query	xxxxx	Returns the name set in [PROJECTOR NAME] of [NETWORK SETUP]
INF1?	Manufacturer name query	BenQ	Returns manufacturer name
INF2?	Model name query	LU9750/LU9800	Returns model name
INF0?	Other information queries	xxxxx	Returns information such as version number
CLASS?	Class information query	I	Returns class for PJLink