

User's Guide

Home Projector

EH-LS300W | androidtv

EH-LS300B | androidtv

Notations Used in This Guide	4	Focusing the Image Using the Focus Lever	26
<hr/>		Selecting an Image Source	27
Introduction to Your Projector	7	Image Aspect Ratio	28
<hr/>		Changing the Image Aspect Ratio	28
Projector Parts and Functions	8	Available Image Aspect Ratios	29
Projector Parts - Front/Top	8	Adjusting Image Quality (Color Mode)	30
Projector Parts - Top/Side	8	Changing the Color Mode	30
Projector Parts - Rear	9	Available Color Modes	31
Projector Parts - Base	10	Turning On Automatic Luminance Adjustment	32
Projector Parts - Control Panel	10	Adjusting Image Quality in Detail	33
Projector Parts - Projector Remote Control	11	Adjusting the Light Source Brightness	34
 		Controlling the Volume with the Volume Buttons	35
Setting Up the Projector	13	Adjusting the Sound Settings (Sound Mode)	36
<hr/>		Available Sound Modes	37
Projector Placement	14	Detailed Sound Settings	37
Precautions on Installation	15	 	
Projector Connections	16	Adjusting Projector Features	38
Connecting to Video Sources	16	<hr/>	
Connecting to External Audio Devices	16	Using the Projector as a Bluetooth Speaker	39
Connecting to an ARC Compatible AV System	17	Bluetooth Specifications	39
Installing Batteries in the Remote Control	18	Shutting Off the Image Temporarily	41
Remote Control Operation	19	HDMI CEC Features	42
Setting Up the Android TV™	20	Operating Connected Devices Using the HDMI CEC Features	42
Android TV™ Home Screen	21	Updating Projector Firmware	44
 		Initializing the Projector	45
Using Basic Projector Features	22	<hr/>	
<hr/>		Adjusting the Menu Settings	46
Turning On the Projector	23	<hr/>	
Turning Off the Projector	24	Using the Projector Settings	47
Image Shape	25		
Correcting the Image Shape with Corner Adjustment	25		

Image Quality Settings - Picture Menu 48
Sound Quality Settings - Sound Menu 50
Projector Feature Settings - Display Menu..... 52
Projector Feature Settings - Settings Menu 53

Maintaining the Projector 54

Projector Maintenance 55
Cleaning the Projection Window 56
Cleaning the Obstacle Sensor and Motion Sensor 57
Cleaning the Projector Case 58
Air Filter and Vent Maintenance 59
 Cleaning the Air Filter 59
 Replacing the Air Filter 60

Solving Problems 62

Projection Problems..... 63
Projector Indicator Status 64
Solving Projector Power-On or Power-Off Problems 66
 Solving Projector Power Problems 66
 Solving Projector Shutdown Problems 66
Solving Image Problems 67
 Solving Missing Image Problems 67
 Adjusting an Image that is not Rectangular 67
 Adjusting a Fuzzy or Blurry Image 68
 Fixing Partial Image Problems 68
 Adjusting an Image that Contains Noise or Static..... 68
 Adjusting an Image with Incorrect Brightness or Colors 69
Solving Sound Problems 70

Solving Missing or Low Audio Problems..... 70
Solving Bluetooth Speaker Mode Problems 70
Solving Remote Control Operation Problems..... 72
Solving HDMI CEC Problems 73
Solving Wi-Fi Network Problems 74
Solving Android TV™ Problems 75

Appendix 76



Optional Accessories and Replacement Parts..... 77
 Screens 77
 Replacement Parts 77
Screen Size and Projection Distance 78
Supported Monitor Display Resolutions..... 79
Projector Specifications..... 80
 Connector Specifications..... 80
External Dimensions 81
List of Safety Symbols and Instructions 82
Laser Safety Information 84
 Laser Warning Labels 84
Glossary..... 86
Notices..... 87
 FCC Compliance Statement 87
 Indication of the manufacturer and the importer in accordance with requirements of EU directive 88
 Restriction of Use..... 88
 Trademarks 88
 Copyright Notice 88
 Copyright Attribution 89

Notations Used in This Guide







Safety Symbols

The projector and its manuals use graphical symbols and labels to indicate content that tells you how to use the projector safely.

Read and carefully follow the instructions that are marked with these symbols and labels to avoid injury to persons or damage to property.

 Warning	This symbol indicates information that, if ignored, could possibly result in personal injury or even death.
 Caution	This symbol indicates information that, if ignored, could possibly result in personal injury or physical damage due to incorrect handling.

General Information Notations

Attention	This label indicates procedures that may result in damage or injury if sufficient care is not taken.
	This label indicates additional information that may be useful to know.
 button	Indicates the buttons on the remote control or the control panel. Example:  button
Menu/Setting name	Indicates projector menu and setting names. Example: Select the Image menu.  Image > Color
	This label indicates links to the related pages.
	This label indicates the projector's current menu level.

Using the Manual to Search for Information

The PDF manual allows you to search for information you are looking for by keyword, or jump directly to specific sections using the bookmarks. You can also print only the pages you need. This section explains how to use a PDF manual that has been opened in Adobe Reader X on your computer.

Searching by keyword

Click **Edit > Advanced Search**. Enter the keyword (text) for information you want to find in the search window, and then click **Search**. Hits are displayed as a list. Click one of the displayed hits to jump to that page.

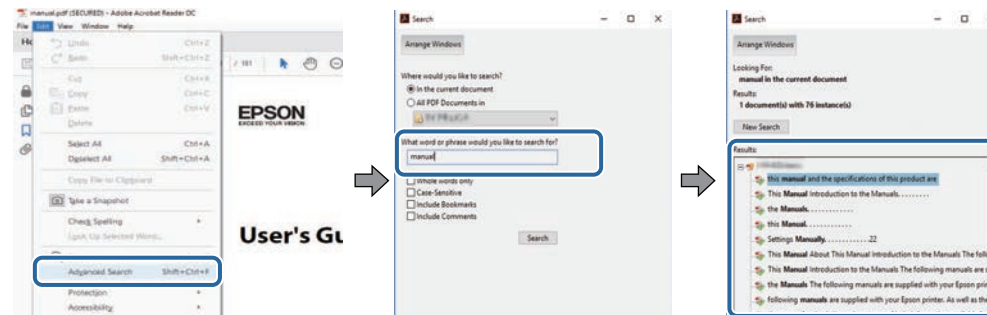

Jumping directly from bookmarks

Click a title to jump to that page. Click + or > to view the lower level titles in that section. To return to the previous page, perform the following operation on your keyboard.

- Windows: Hold down **Alt**, and then press ←.
- Mac OS: Hold down the command key, and then press ←.

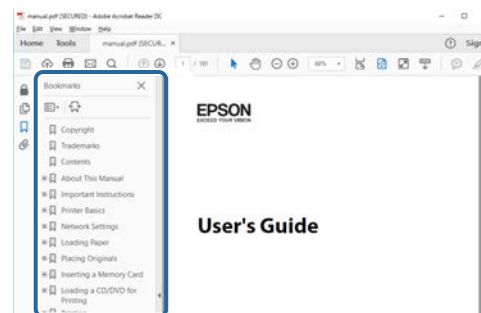

Printing only the pages you need

You can extract and print only the pages you need. Click **Print** in the **File** menu, and then specify the pages you want to print in **Pages in Pages to Print**.

- To specify a series of pages, enter a hyphen between the start page and the end page.
Example: 20-25

- To specify pages that are not in series, divide the pages with commas.
Example: 5, 10, 15

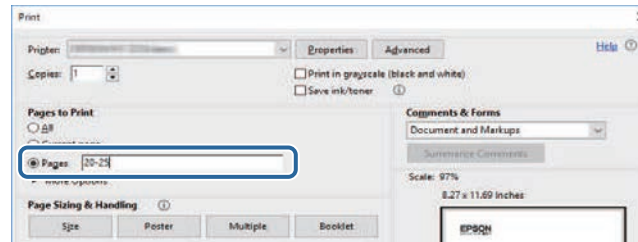

Introduction to Your Projector

See these sections to learn more about your projector.

► **Related Links**

- "Projector Parts and Functions" [p.8](#)

The following sections explain the projector parts and their functions.

► **Related Links**

- "Projector Parts - Front/Top" [p.8](#)
- "Projector Parts - Top/Side" [p.8](#)
- "Projector Parts - Rear" [p.9](#)
- "Projector Parts - Base" [p.10](#)
- "Projector Parts - Control Panel" [p.10](#)
- "Projector Parts - Projector Remote Control" [p.11](#)

Name	Function
⑦ Status indicator	Indicates the projector's status.

► **Related Links**

- "Air Filter and Vent Maintenance" [p.59](#)
- "Remote Control Operation" [p.19](#)
- "Projector Indicator Status" [p.64](#)
- "Focusing the Image Using the Focus Lever" [p.26](#)

Projector Parts - Front/Top

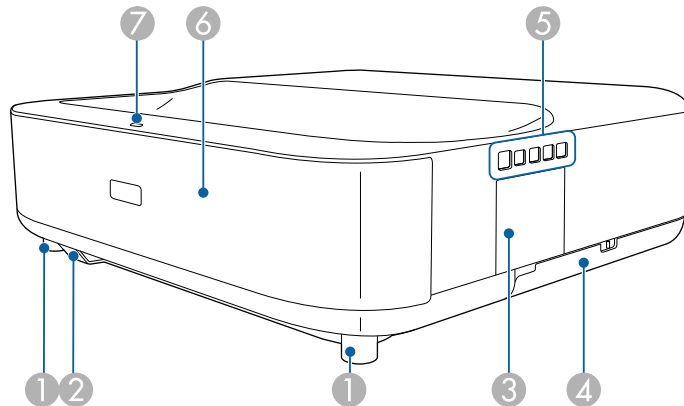

Name	Function
① Front adjustable feet	When setup on a surface such as a desk, turn to extend and retract the feet to adjust the horizontal tilt.
② Remote receiver	Receives signals from the remote control.
③ Focus lever cover	Open to access the focus lever.
④ Air filter cover	Open to access the air filter.
⑤ Control panel	Operates the projector.
⑥ Speaker	Outputs audio.

Projector Parts - Top/Side

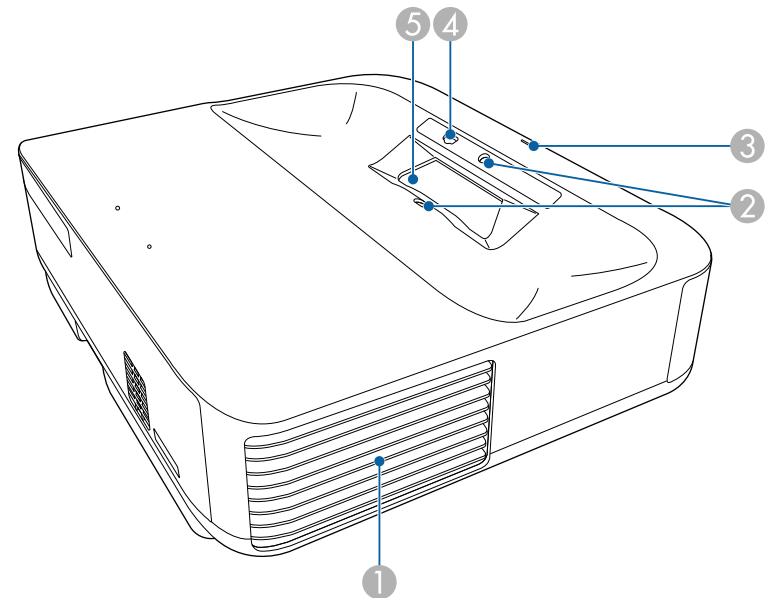

Name	Function
① Air exhaust vent	Exhaust vent for air used to cool the projector internally. <div style="border: 1px solid black; padding: 5px;"> <p>⚠ Caution</p> <p>While projecting, do not put your face or hands near the air exhaust vent, and do not place objects that may become warped or damaged by heat near the vent. Hot air from the air exhaust vent could cause burns, warping, or accidents to occur.</p> </div>
② Obstacle sensors	Detect obstacles that are interfering with the projection area.
③ Status indicator	Indicates the projector's status.
④ Motion sensor	Detects movement near the projection window and reduces the brightness of the light source for safety. <div style="border: 1px solid black; padding: 5px;"> <p> • The detection range may vary depending on the temperature of the surroundings.</p> <p>• Movement may not be detected through transparent material such as glass.</p> </div>
⑤ Projection window	Images are projected from the lens inside the projector. <div style="border: 1px solid black; padding: 5px;"> <p>⚠ Warning</p> <ul style="list-style-type: none"> • Do not look into the projection window while projecting. • Do not place any objects or put your hand near the projection window. It could cause burns, fire, or the object to warp because this area reaches a high temperature due to the concentrated projection light. </div>

» **Related Links**

- "Projector Indicator Status" [p.64](#)
- "Cleaning the Obstacle Sensor and Motion Sensor" [p.57](#)

Projector Parts - Rear

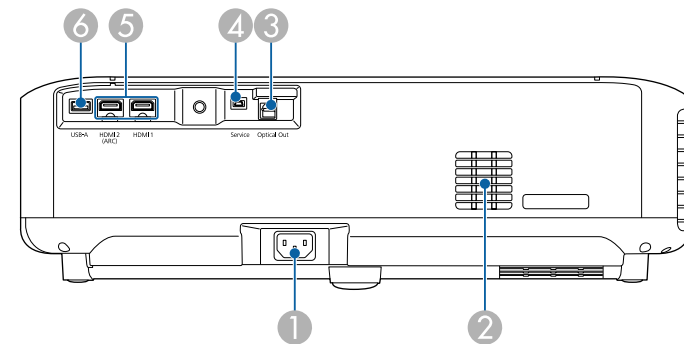

Name	Function
① Power inlet	Connects the power cord to the projector.
② Air intake vent	Takes in air to cool the projector internally.
③ Optical Out port	Outputs audio to an external audio system by connecting an optical digital audio cable.
④ Service port	This port is not normally used.
⑤ HDMI1 port HDMI2 (ARC) port	Inputs video signals from HDMI compatible video equipment and computers. This projector is compatible with HDMI 2.3. HDMI2 port is compatible with HDMI ARC.

Name	Function
⑥ USB-A port	<p>Connects a commercially available USB device such as a webcam, external HDD, or keyboard.</p> <p>Connects a commercially available RJ45 adapter to enable wired LAN connections.</p> <div style="border: 1px solid black; padding: 5px; margin-top: 10px;">  This port is not guaranteed to operate for all devices that support USB. </div>

» **Related Links**

- "Connecting to Video Sources" [p.16](#)
- "Connecting to an ARC Compatible AV System" [p.17](#)
- "Connecting to External Audio Devices" [p.16](#)

Name	Function
① Rear foot	Stabilizes the projector on a surface such as a desk.
② Air intake vent (air filter)	Takes in air to cool the projector internally.
③ Front adjustable feet	When setup on a surface such as a desk, turn to extend and retract the feet to adjust the horizontal tilt.

» **Related Links**

- "Air Filter and Vent Maintenance" [p.59](#)

Projector Parts - Base

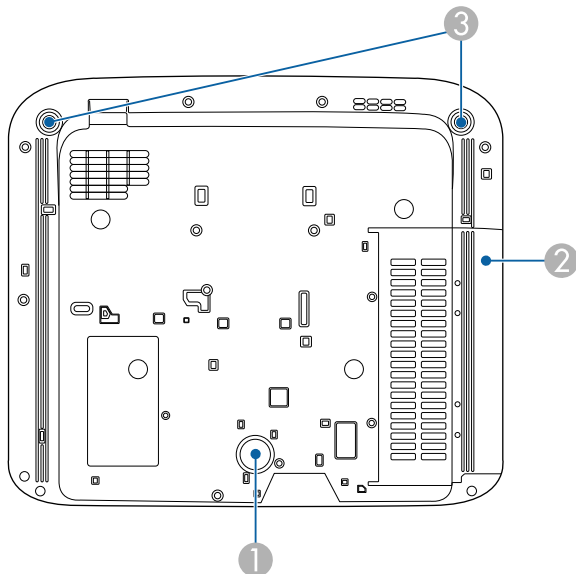

Projector Parts - Control Panel

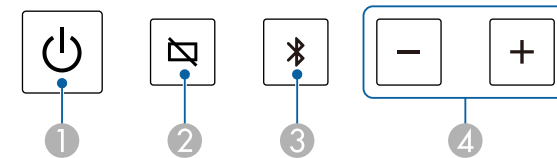







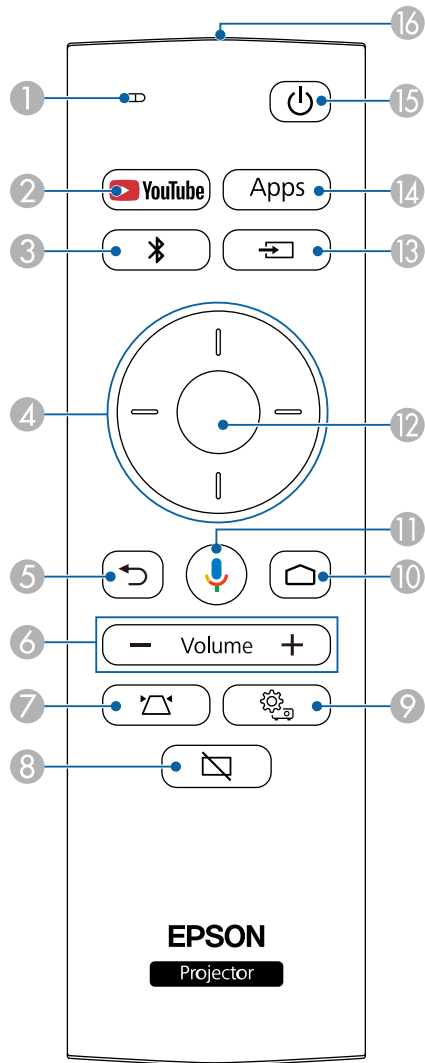

Name	Function
① Power button	Turns the projector on or off.
② Blank button	Turns the video on or off temporarily.
③ Bluetooth Speaker Mode button	Switches to the Bluetooth Speaker Mode.
④ Volume up/down buttons	Adjusts the volume for the speaker.



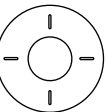

» **Related Links**

- "Projector Indicator Status" [p.64](#)
- "Using the Projector as a Bluetooth Speaker" [p.39](#)

Projector Parts - Projector Remote Control



Name	Function
① Indicator/Microphone	Turns on when outputting signals from the remote control. Detects audio when you press the Mic button.
② YouTube button 	Starts the YouTube application.
③ Bluetooth Speaker Mode button 	Switches to the Bluetooth Speaker Mode.
④ Arrow buttons 	Selects menu items while displaying the projector's menu.
⑤ Esc button 	Stops the current function. Moves back to the previous menu level while displaying the projector's menu.
⑥ Volume up/down buttons 	Adjusts the volume for the speaker.
⑦ Projector Installation button 	Displays the Corner Adjustment screen to adjust the shape of the projected image.
⑧ Blank button 	Turns the video on or off temporarily.
⑨ Projector Settings button 	Displays and closes the projector's menu. You can use the projector's menus to adjust the settings that control how your projector works.

Name		Function
10	Home button 	Displays the Android TV™ home screen.
11	Google Search button 	Searches with your voice. When you press this button, the remote control's microphone starts listening for voice commands.
12	[Enter] button	Enters the current selection and moves to the next level while displaying the projector's menu.
13	Source Search button 	Displays a list of available input sources.
14	Apps button 	Displays a list of the applications available on the Android TV™.
15	Power button 	Turns the projector on or off.
16	Remote control light emitting area	Outputs remote control signals.

» Related Links

- "Using the Projector as a Bluetooth Speaker" [p.39](#)
- "Correcting the Image Shape with Corner Adjustment" [p.25](#)
- "Turning On the Projector" [p.23](#)
- "Controlling the Volume with the Volume Buttons" [p.35](#)
- "Shutting Off the Image Temporarily" [p.41](#)
- "Using the Projector Settings" [p.47](#)

Setting Up the Projector

Follow the instructions in these sections to set up your projector.

► Related Links

- "Projector Placement" [p.14](#)
- "Projector Connections" [p.16](#)
- "Installing Batteries in the Remote Control" [p.18](#)
- "Setting Up the Android TV™" [p.20](#)

Install the projector on a table in your living room or on a low shelf to project images.

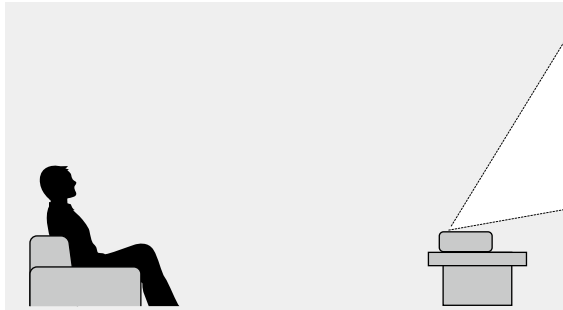

- If the image is tilted, rotate the front feet to adjust their height.

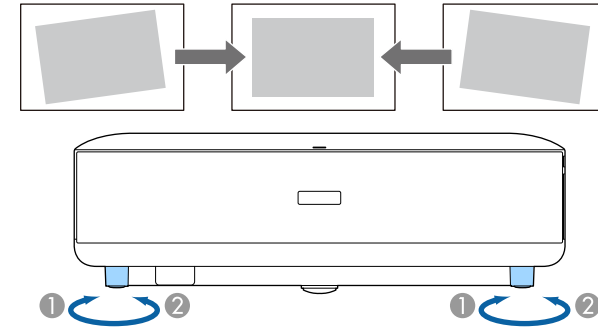

Note the following points when selecting a projector location:

- Place the projector on a sturdy and level surface.

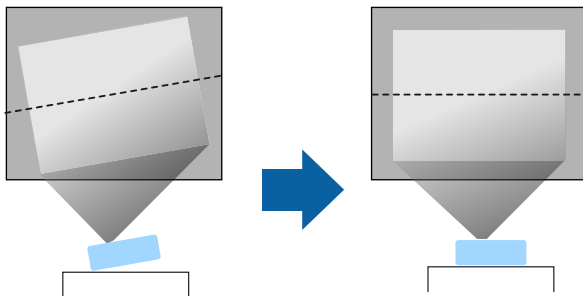

- Leave plenty of space around and under the projector for ventilation, and do not place it on top of or next to anything that could block the vents.
- Place the projector so it squarely faces the screen, not at an angle.

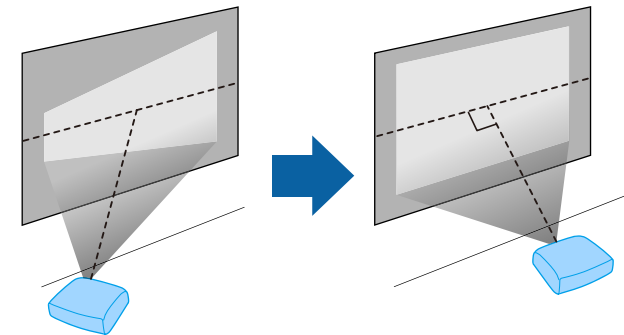

If you cannot install the projector squarely facing the screen, correct any resulting keystone distortion using the **Corner Adjustment** function. For the best quality images, we recommend adjusting the installation position of the projector to achieve the correct image size and shape.

⚠ Warning

Do not install the projector in a location subject to high levels of dust or humidity, or in a location subject to smoke or steam. Otherwise, it could cause a fire or electric shock to occur.

⚠ Warning

- Do not cover the projector's air intake or air exhaust vents. If the vents are covered, the internal temperature could rise and cause a fire.
- Do not use or store the projector in locations where it will be subject to dust or dirt. Otherwise, the quality of the projected image may decline, or the air filter may become clogged, resulting in a malfunction or fire.
- Do not install the projector on an unstable surface or in a location beyond the weight specifications of the projector. Otherwise, it could fall or topple causing an accident and injury.
- When installing the projector in a high position, take measures to prevent falling by using wires to ensure safety in an emergency, such as an earthquake, and to prevent accidents. If it is not installed correctly, it could fall causing an accident and injury.
- Do not install in locations where salt damage could occur, or in locations subject to corrosive gas such as sulphuric gas from hot springs. Otherwise, corrosion could cause the projector to fall. It could also cause the projector to malfunction.

Attention

If you are using the projector at altitudes above 1,500 m, set the **High Altitude Mode** setting to **On** in the projector's menu to ensure the projector's internal temperature is regulated properly.

🖱 **Settings > High Altitude Mode**

» Related Links

- "Precautions on Installation" [p.15](#)
- "Image Shape" [p.25](#)
- "Focusing the Image Using the Focus Lever" [p.26](#)

Precautions on Installation

Note the following precautions when installing the projector.

Installation space

Attention

Be sure to leave the following amount of space around the projector so as not to block the air exhaust and intake vents.

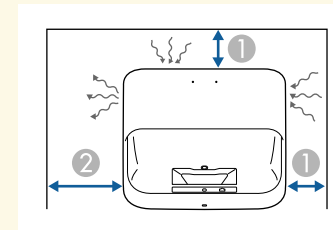

① 10 cm

② 30 cm

See these sections to connect the projector to a variety of projection sources.

Attention

Check the shape and orientation of the connectors on any cable you plan to connect. Do not force a connector into a port if it does not fit. The device or your projector could be damaged or could malfunction.

Related Links

- "Connecting to Video Sources" [p.16](#)
- "Connecting to External Audio Devices" [p.16](#)
- "Connecting to an ARC Compatible AV System" [p.17](#)

Connecting to Video Sources

If your video source has an HDMI port, you can connect it to the projector using an HDMI cable and send the image source's audio with the projected image.

Attention

Do not turn on the video source before connecting it to the projector. Doing so could damage the projector.



- If the port on the device you connect has an unusual shape, use the cable supplied with the device or an optional cable to connect to the projector.
- Some video equipment is capable of outputting different types of signals. See your video equipment manual to confirm what type of signals can be output.

- 1 Connect the HDMI cable to your video source's HDMI output port.

- 2 Connect the other end to the projector's HDMI port.

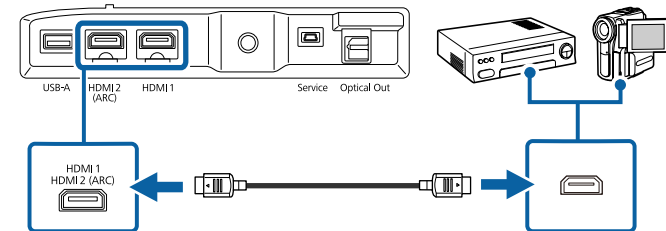

Connecting to External Audio Devices

If your amplifier or speaker has an optical digital audio input port, you can connect it to the projector using an optical digital audio cable and project audio from the image source.

- 1 Connect the optical digital audio cable to your audio device's optical digital audio input port.

- 2 Connect the other end to the projector's Optical Out port.

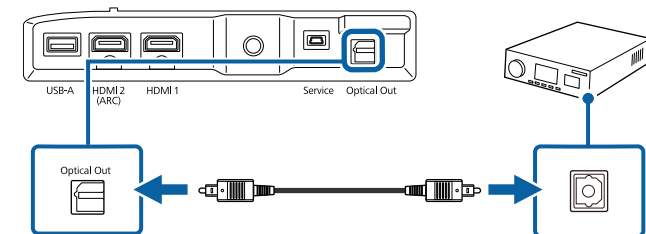

If you want to output higher quality audio, set **Sound Output Format** as **Auto** in the projector's **Sound** menu.

Connecting to an ARC Compatible AV System

If your AV system has an HDMI port, you can connect it to the projector using an HDMI cable (ARC compatible) to output audio to the AV system.

- 1** Connect the HDMI cable to your video source's HDMI input port (ARC compatible).
- 2** Connect the other end to the projector's HDMI2 (ARC) port.

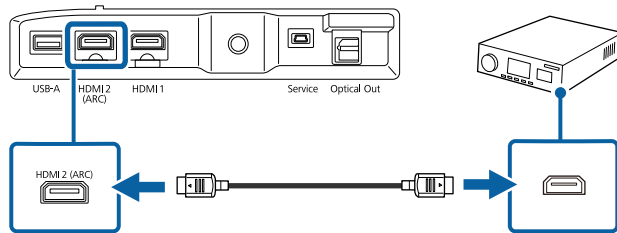

- To output audio from the projector's HDMI2 (ARC) port, set **HDMI2 ARC to On** and **Sound Output Device to ARC** in the projector's menu.
 - Settings > HDMI CEC > CEC Control > HDMI2 ARC
 - Sound > Sound Output Device
- If you want to output higher quality audio, set **Sound Output Format as Auto** in the projector's **Sound** menu.

The remote control uses the two AAA batteries that came with the projector.

Attention

Make sure you read the *Safety Instructions* before handling the batteries.

- 1 Remove the battery cover as shown.

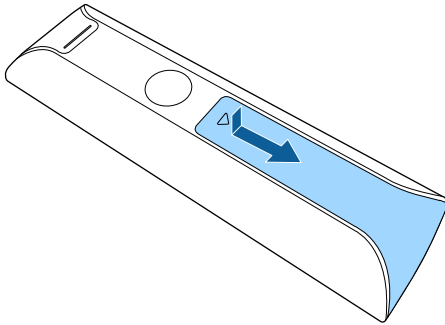

- 2 Remove the old batteries, if necessary.



Dispose of used batteries according to local regulations.

- 3 Insert the batteries with the + and – ends facing as shown.

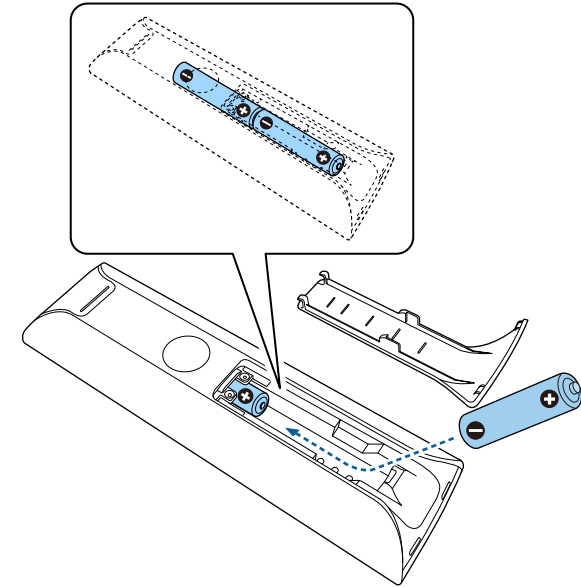

Warning

Check the positions of the (+) and (–) marks inside the battery holder to ensure the batteries are inserted the correct way. If the batteries are not used correctly, they could explode or leak causing a fire, injury, or damage to the product.

- 4** Replace the battery cover and press it down until it clicks into place.

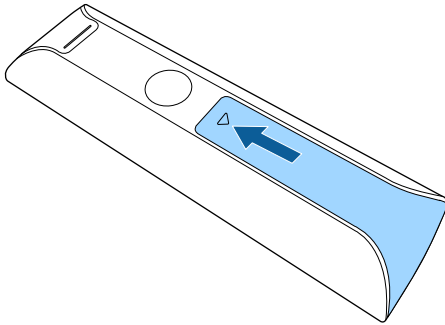

Avoid using the remote control in conditions with bright fluorescent lights or in direct sunlight, or the projector may not respond to commands. If you are not going to use the remote control for a long time, remove the batteries.

► Related Links

- "Remote Control Operation" [p.19](#)



Remote Control Operation

The remote control lets you control the projector from almost anywhere in the room.

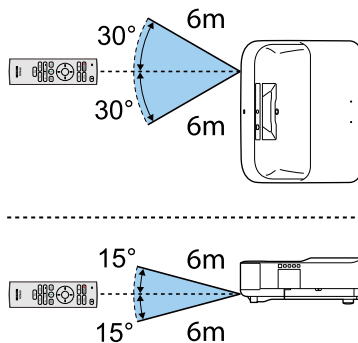
It is recommended that you aim the remote control at the projector's receivers within the distance and angles listed here.



When you turn on the projector for the first time, you need to setup the built-in Android TV™.

 You can change each of the settings even after completing the initial setup. Change the settings in the menu displayed when you press  at the top right of the Android TV™ home screen.

- 1** Turn on the projector.
- 2** When the pairing screen is displayed, hold down the [Enter] button and  button on the remote control at the same time to pair the remote control and the projector.

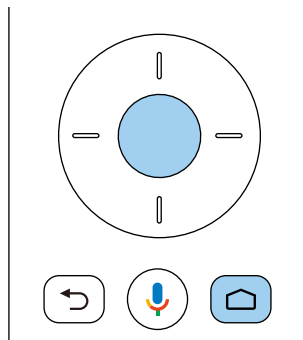

 When pairing starts, the indicator on the remote control flashes. When pairing is complete, the indicator turns off.

- 3** When the language selection screen is displayed, select the language you want to use.

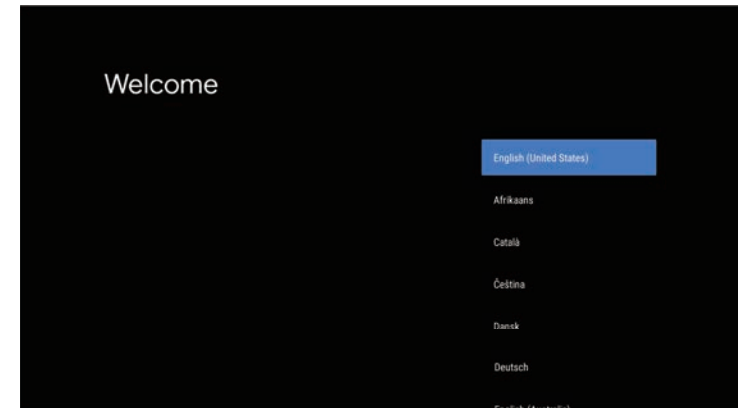

- 4** When the Wi-Fi setting screen is displayed, select the wireless network you want to use, and then follow the on-screen instructions to make necessary settings.
 - An internet connection is required to view online content. Make sure you can use the Wi-Fi service.
 - The customer is responsible for any communication charges incurred when downloading the app or watching online content.
- 5** When the login screen is displayed, sign in using your Google account.
 - You can download various popular apps and games on Google Play by signing in with your Google account.
 - You can also create a Google account on your computer or smart device.

When you have finished the initial setup, the home screen is displayed.

» Related Links

- "Android TV™ Home Screen" [p.21](#)

Android TV™ Home Screen

When you turn on the projector or press the  button on the remote control, the Android TV™ home screen is displayed.

You can easily access online content, applications, and projector settings from the home screen.

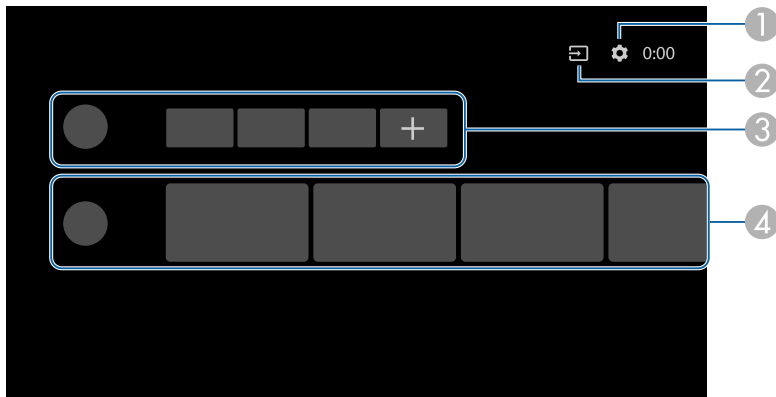

- 1 Displays the **Settings** menu of the Android TV™. You can select various settings such as Wi-Fi setting, language setting, and Google account information.
- 2 Displays a list of available input sources.
- 3 Displays the applications downloaded on the Android TV™. You can add applications to this list by selecting the + icon.
- 4 Displays the online content recommended by the applications.



The content of the home screen may change depending on the version of the Android TV™.

Using Basic Projector Features

Follow the instructions in these sections to use your projector's basic features.

► Related Links

- "Turning On the Projector" [p.23](#)
- "Turning Off the Projector" [p.24](#)
- "Image Shape" [p.25](#)
- "Focusing the Image Using the Focus Lever" [p.26](#)
- "Selecting an Image Source" [p.27](#)
- "Image Aspect Ratio" [p.28](#)
- "Adjusting Image Quality (Color Mode)" [p.30](#)
- "Turning On Automatic Luminance Adjustment" [p.32](#)
- "Adjusting Image Quality in Detail" [p.33](#)
- "Adjusting the Light Source Brightness" [p.34](#)
- "Controlling the Volume with the Volume Buttons" [p.35](#)
- "Adjusting the Sound Settings (Sound Mode)" [p.36](#)

When you connect the video equipment to the projector, turn on the video equipment you want to use after you turn on the projector.

- 1** Connect the power cord to the projector's power inlet and plug it into an electrical outlet.

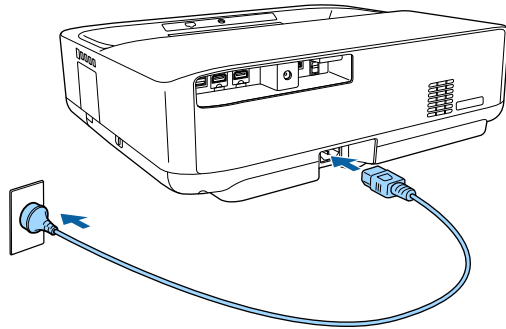

The projector enters standby mode. This indicates that the projector is receiving power, but is not yet turned on.

- 2** Press the power button on the control panel or remote control to turn on the projector.

The status indicator flashes blue as the projector warms up. Once the projector is warmed up, the status indicator stops flashing and turns blue.

The first time you turn on the projector, the remote control pairing screen and initial setup screen are displayed. Follow the on-screen instructions to complete the settings.

Warning

- Never look into the projector lens when the light source is on. This can damage your eyes and is especially dangerous for children.
- When turning on the projector at a distance using the remote control, make sure there is no one looking into the lens.
- During projection, do not block the light from the projector with a book or other objects. If the light from the projector is blocked, the area on which the light shines becomes hot which could cause it to melt, burn, or start a fire. Also, the lens may get hot due to the reflected light which could cause the projector to malfunction. To stop projection, turn off the projector.



When using at an altitude of 1,500 m or more, set **High Altitude Mode** to **On**.

 **Settings > High Altitude Mode**

» Related Links

- "Projector Feature Settings - Settings Menu" [p.53](#)

Turn off the projector after use.



- Turn off this product when it is not in use to prolong the life of the projector. Light source life varies depending on the environmental conditions and usage. Brightness decreases over time.

1 Press the power button on the control panel or remote control.
The light source turns off, and the status indicator turns off.

2 To transport or store the projector, make sure the status indicator on the projector is off, and then unplug the power cord.



- You can keep supplying power to the projector by selecting **Suspend** as **Power Button Setting**. This lets the projector start earlier when you turn it on.
- When **Power Button Setting** is set to **Suspend**, you can turn on the projector by pressing any button on the control panel or remote control.

☛ **Settings > Power Button Setting**

» Related Links

- "Projector Feature Settings - Settings Menu" [p.53](#)

You can project an even, rectangular image by placing the projector directly in front of the center of the screen and keeping it level. If you place the projector at an angle to the screen, or tilt it up or down, or off to the side, you may need to correct the image shape.

After correction, your image is slightly smaller.

For the best quality images, we recommend adjusting the installation position of the projector to achieve the correct image size and shape.

► Related Links

- "Correcting the Image Shape with Corner Adjustment" [p.25](#)

Correcting the Image Shape with Corner Adjustment

You can correct the shape and size of an image that is unevenly rectangular by using the projector's **Corner Adjustment** menu.

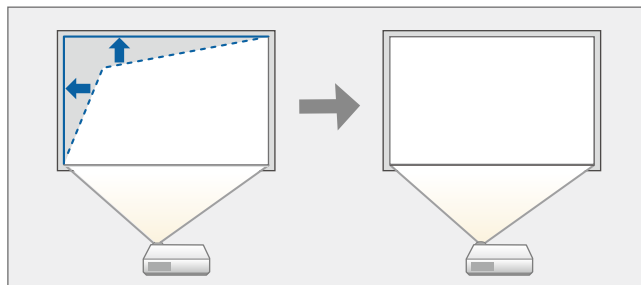

- 1** Turn on the projector and display an image.
- 2** Press the  button on the remote control. The **Corner Adjustment** screen is displayed.

- 3** Use the arrow buttons to select the point on the image you want to adjust, and then press [Enter].

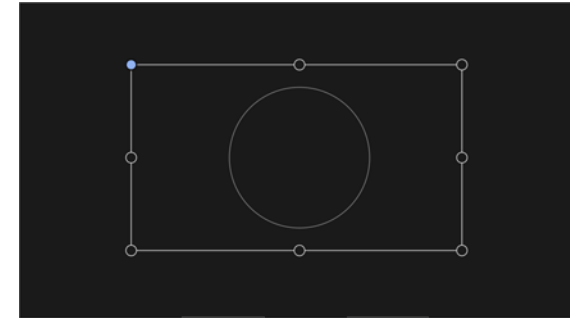

- 4** Press the arrow buttons to adjust the image shape as necessary.

To return to the area selection screen, press .



If the direction key on the screen turns gray, you cannot make further adjustments in that direction.

- 5** Repeat steps 3 and 4 as needed to adjust any remaining points.
- 6** When you are finished, press .

► Related Links

- "Projector Feature Settings - Display Menu" [p.52](#)

You can correct the focus using the focus lever.

- 1** Open the focus lever cover.

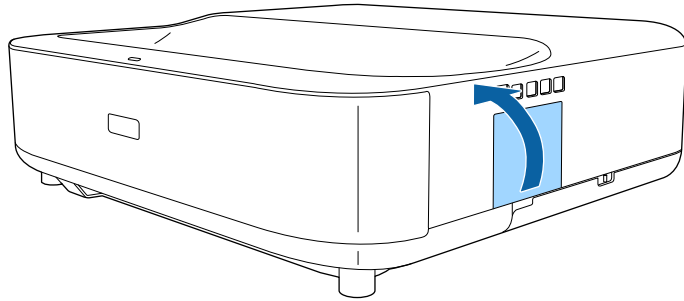

- 2** Move the focus lever to adjust the focus.

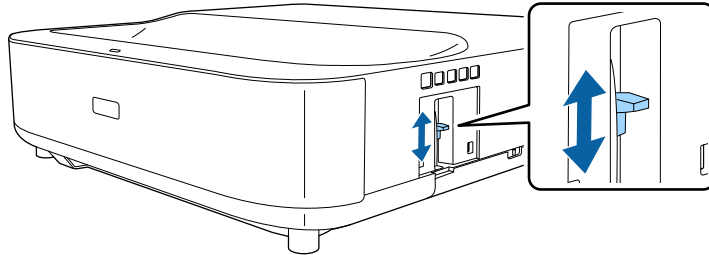

- 3** Close the focus lever cover.

When multiple image sources are connected to the projector, such as a computer and DVD player, you can switch from one image source to the other.

- 1** Make sure the connected image source you want to use is turned on.
- 2** For video image sources, insert a DVD or other video media and press play.
- 3** Press the  button on the remote control.
- 4** Press the up or down arrow button to select the image source you want.



When no image signal is detected, check the cable connections between the projector and the image source.

The projector can display images in different width-to-height ratios called aspect ratios. Normally, the input signal from your video source determines the image's aspect ratio. However, you can change the aspect ratio for certain images to fit your screen.

If you always want to use a particular aspect ratio for a certain video input source, you can select it using the projector's **Picture** menu.

► Related Links

- "Changing the Image Aspect Ratio" [p.28](#)
- "Available Image Aspect Ratios" [p.29](#)

Changing the Image Aspect Ratio

You can change the aspect ratio of the displayed image.

- 1** Turn on the projector and display an image.
- 2** Press the  button on the remote control.

- 3** Select the **Picture** and press the [Enter] button.

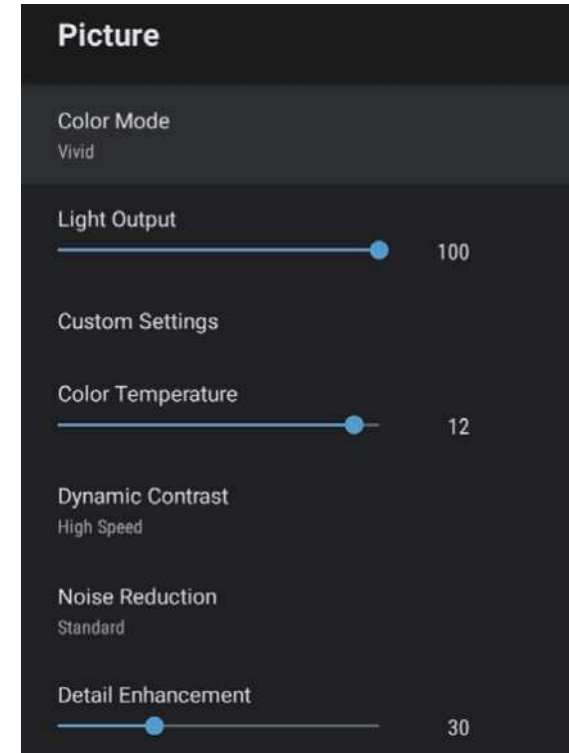

- 4** Select **Aspect Ratio** and press [Enter].
- 5** Select one of the available aspect ratios for your input signal and press [Enter].
- 6** Press  to exit the menus.

Available Image Aspect Ratios

You can select the following image aspect ratios, depending on the input signal from your image source.



- Note that using the aspect ratio function of the projector to reduce, enlarge, or split the projected image for commercial purposes or for public viewing may infringe upon the rights of the copyright holder of that image based on copyright law.

Aspect mode	Description
Normal	Automatically sets the aspect ratio according to the input signal.
Full	Displays images using the full size of the projection area, but does not maintain the aspect ratio.
Zoom	Displays images using the full width of the projection area and maintains the aspect ratio of the image.

The projector offers different color modes to provide optimum brightness, contrast, and color for a variety of viewing environments and image types. You can select the mode designed to match your image and environment, or experiment with the available modes.

» Related Links

- "Changing the Color Mode" [p.30](#)
- "Available Color Modes" [p.31](#)

Changing the Color Mode

You can change the projector's **Color Mode** using the remote control to optimize the image for your viewing environment.

- 1** Turn on the projector and display an image.
- 2** Press the  button on the remote control.

- 3** Select the **Picture** menu and press the [Enter] button.

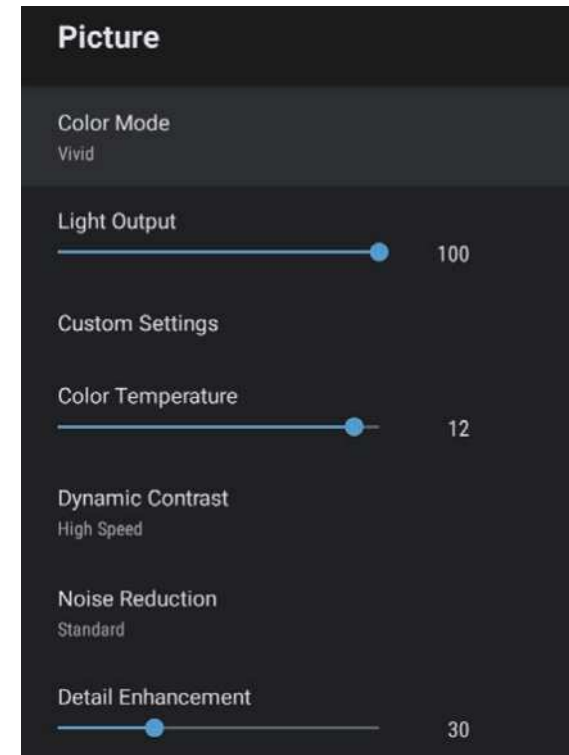

- 4** Select **Color Mode** and press [Enter].
- 5** Select the color mode you want to use from the list and press [Enter].
- 6** Press  to exit the menus.

» Related Links

- "Image Quality Settings - Picture Menu" [p.48](#)

Available Color Modes

You can set the projector to use these color modes, depending on your environment and image types.

Color mode	Description
Dynamic	This is the brightest mode. Best for prioritizing brightness.
Vivid	Best for enjoying various content in a bright environment.
Bright Cinema	Best for enjoying content such as movies in a bright environment.
Cinema	Best for enjoying content such as movies in a dark environment.
Natural	Best for adjusting the image color.

You can turn on Dynamic Contrast to automatically optimize the image luminance. This improves the image contrast based on the brightness of the content you project.

- 1** Turn on the projector and display an image.
- 2** Press the  button on the remote control.
- 3** Select the **Picture** menu and press the [Enter] button.

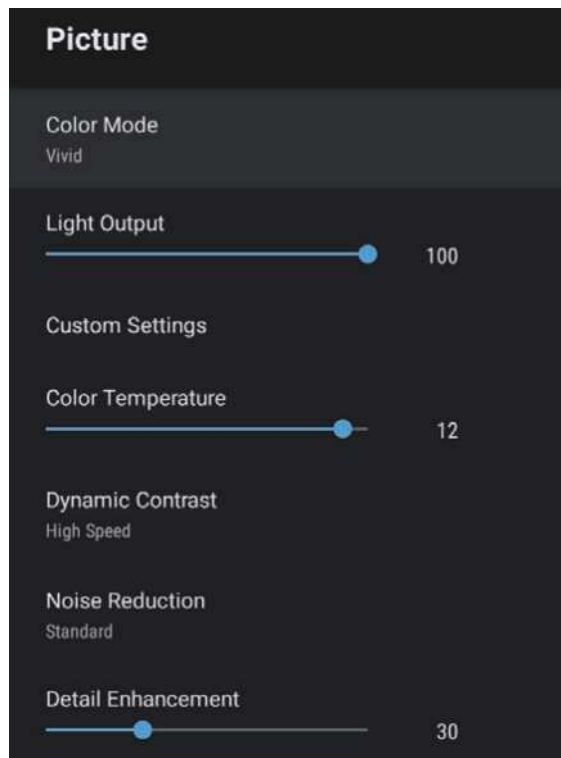

- 4** Select **Dynamic Contrast** and press [Enter].

- 5** Select one of the following options and press [Enter]:
 - **High Speed** to adjust brightness as soon as the scene changes.
 - **Normal** for standard brightness adjustment.

- 6** Press  to exit the menus.

» Related Links

- "Image Quality Settings - Picture Menu" [p.48](#)

You can fine-tune various aspects of how quality and colors are displayed in your projected images.

- 1 Turn on the projector and display an image.
- 2 Press the  button on the remote control.
- 3 Select the **Picture** menu and press the [Enter] button.

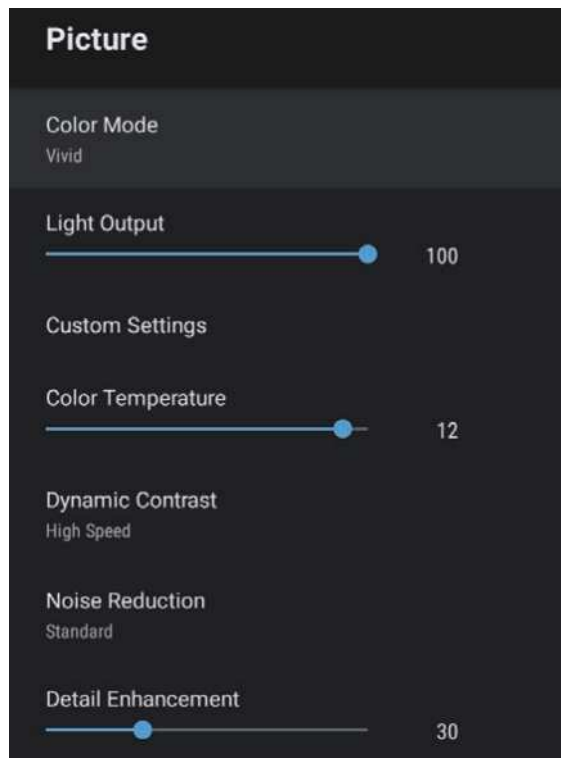

- 4 Select **Custom Settings** and press [Enter].

- 5 Select one of the following options:
 - To adjust the overall color brightness of the color, adjust the **Brightness** setting.
 - To adjust the difference between light and dark areas of the image, adjust the **Contrast** setting.
 - To adjust the overall vividness of the color, adjust the **Saturation** setting.
 - To adjust the balance of green to magenta tones in the image, adjust the **Tint** setting.
 - To adjust the outline of the image, adjust the **Sharpness** setting.
- 6 Press  to exit the menus.



You can set the overall color tone by adjusting the **Color Temperature** setting in the **Picture** menu if the image is too bluish or reddish.

» Related Links

- "Image Quality Settings - Picture Menu" [p.48](#)

You can adjust the brightness of your projector's light source.

- 1** Turn on the projector and display an image.
- 2** Press the  button on the remote control.
- 3** Select the **Picture** menu and press the [Enter] button.

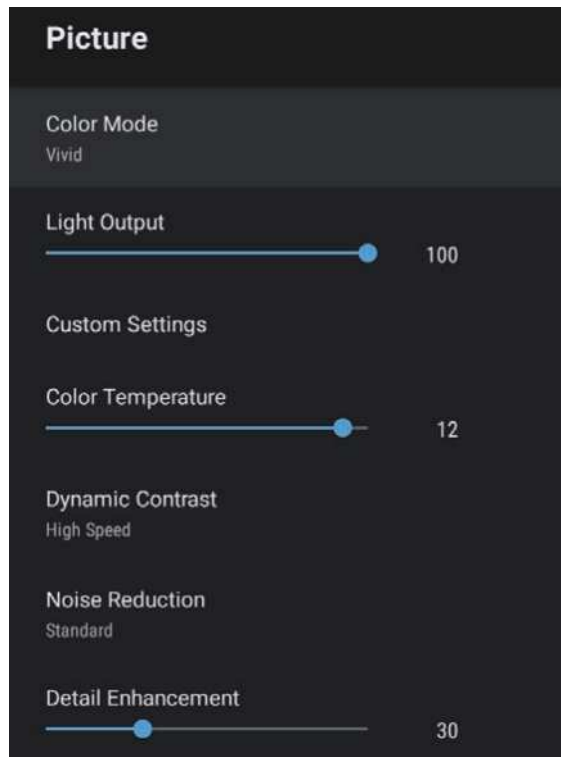



- 4** Select **Light Output**.
- 5** Press the left and right arrow buttons to select the brightness.

- 6** Press  to exit the menus.

» Related Links

- "Image Quality Settings - Picture Menu" [p.48](#)

The volume buttons control the projector's internal speaker system.

- 1** Turn on the projector and start a video.
- 2** To lower or raise the volume, press the  or  button on the control panel or remote control.

A volume gauge appears on the screen.

Caution

Do not start a playback at a high volume setting. Sudden loud noises may cause hearing loss.

Always lower the volume before powering off, so that you can power on and then gradually increase the volume.

The projector offers various sound settings to fine-tune the sound quality for a variety of listening environments.

You can select the mode designed to match your image, or experiment with the available modes.



Sound settings explained in the following section are only available for sound that is being output from the projector's speaker.

- 1** Turn on the projector and start a video.
- 2** Press the  button on the remote control.

- 3** Select the **Sound** menu and press the [Enter] button.

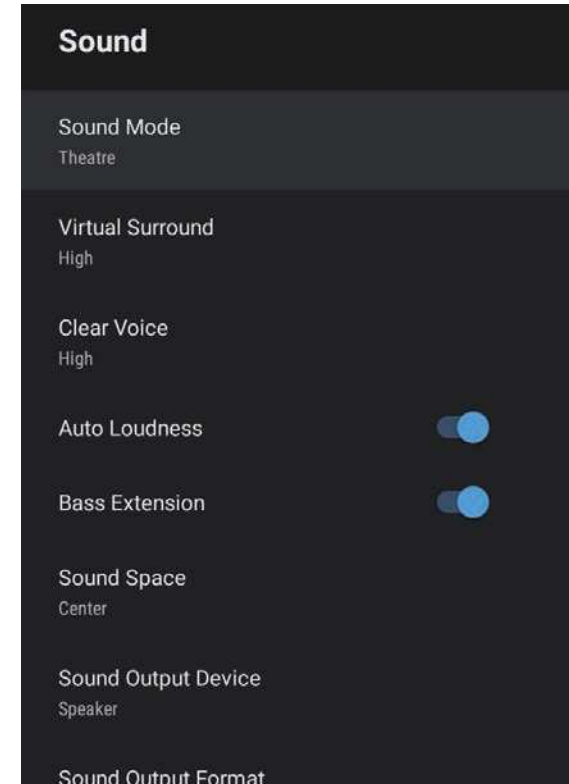

- 4** Select **Sound Mode** and press [Enter].
- 5** Select your sound mode and press [Enter].
- 6** Select detailed sound settings such as surround-sound effect and make settings according to your listening environment as necessary.
- 7** Press  to exit the menus.

» **Related Links**

- "Available Sound Modes" [p.37](#)
- "Detailed Sound Settings" [p.37](#)
- "Sound Quality Settings - Sound Menu" [p.50](#)

Available Sound Modes

You can set the following sound modes in the projector's **Sound** menu.

Sound mode	Description
Theatre	The surround effect recreates the acoustic environment of a movie theater. Allows you to enjoy realistic and powerful sound.
TV	Plays back voice clearly. This is ideal for watching news, documentaries, and other TV shows.
Studio	With a wide frequency range of playback and balanced sound quality, this feature reproduces the sound intended by creators and artists.
Stadium	This realistically reproduces the atmosphere of stadiums and crowds, providing you with clear, live voice play back. Allows you to enjoy watching sports in a realistic atmosphere.
Concert	This reproduces the echoes and expanse of a concert venue, giving you a true sense of elation.
Karaoke Mode	This is ideal for playing back karaoke content as it reproduces the echoes and expanse of a concert venue. Allows you to play songs without sacrificing the vocal effects provided by karaoke apps and microphones.

Detailed Sound Settings

You can set the projector to use these detailed sound menus depending on your listening environment.

Setting	Description
Virtual Surround	Adjusts the strength of the surround effect. This setting is saved for each Sound Mode.
Clear Voice	Adjusts the voice so that it can be heard clearly. This setting is saved for each Sound Mode.
Auto Loudness	Even when playing at low volumes, this automatically corrects the balance between high and low tones in the audio so that they are not out of balance.
Bass Extension	Emphasizes the bass levels to reproduce a powerful bass.
Sound Space	Adjusts the sound quality to suit your viewing position.
Sound Output Device	Selects the sound output device. Speaker: Outputs sound from the projector's speakers. ARC: Outputs sound from an ARC compatible AV system. Connect an HDMI cable to the projector's HDMI2 (ARC) port.
Sound Output Format	Selects the sound output format when you output audio to an external audio device. PCM: Outputs sound in PCM format (2 ch). Auto: Outputs higher quality sound. This projector supports the following audio codecs: <ul style="list-style-type: none"> • PCM (2 ch) • AC-3 (up to 5.1 ch) • DTS (up to 5.1 ch) <div style="border: 1px solid black; background-color: #ffffcc; padding: 5px; margin-top: 10px;">  If sound is not output correctly, select PCM. </div>
Audio Output Latency	Adjusts the audio latency. If the audio is fast, select a higher value. This item is only available for the following types of audio: <ul style="list-style-type: none"> • audio output from the projector's speaker • audio output from the HDMI2 (ARC) port • audio output from the Optical Out port

Adjusting Projector Features

Follow the instructions in these sections to use your projector's adjustment features.

► **Related Links**

- "Using the Projector as a Bluetooth Speaker" [p.39](#)
- "Shutting Off the Image Temporarily" [p.41](#)
- "HDMI CEC Features" [p.42](#)
- "Updating Projector Firmware" [p.44](#)
- "Initializing the Projector" [p.45](#)

You can use the projector's speaker to output audio from a video/audio device connected by Bluetooth.

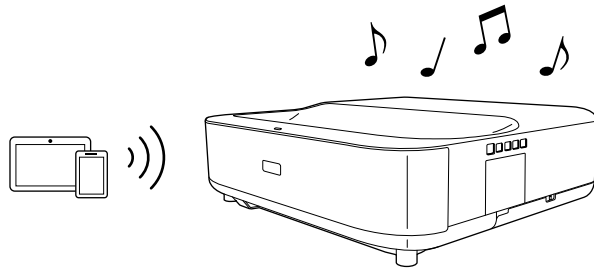

- 1 Press the  button on the control panel or remote control to enter **Bluetooth Speaker Mode**.

After switching to **Bluetooth Speaker Mode**, the following message is displayed.

Bluetooth Speaker Mode On

- 2 Enable the Bluetooth function on the device you want to connect and select **Projector** from the available device list. See the documentation supplied with the device for more information.



- When you want to enjoy the sound only from the projector, you can temporarily turn off the projected image by pressing the  button on the control panel or remote control.
- To cancel a Bluetooth connection, disconnect from the connected device.

- 3 To exit **Bluetooth Speaker Mode**, press  again.

After exiting **Bluetooth Speaker Mode**, the following message is displayed.

Bluetooth Speaker Mode Off



- There is a delay in the audio output from any Bluetooth audio device.
- You cannot connect multiple video/audio devices by Bluetooth at the same time.
- You can also connect the projector to Bluetooth audio devices, such as speakers or headphones, to output the projector's audio from these devices. Perform pairing by selecting **Device Preferences** from  at the top right of the Android TV™ home screen.
- Bluetooth audio devices are not supported in some countries and regions.

» Related Links

- "Bluetooth Specifications" [p.39](#)

Bluetooth Specifications

Version	Bluetooth Ver. 5.0
Supported profiles	A2DP, AVRCP, HID, HOGP
Frequency used	2.4 GHz band (2.402 to 2.480 GHz)

Warning



Do not use the device near any medical equipment or equipment that is automatically controlled, such as automatic doors or fire alarms. Electromagnetic interference from the device may cause such equipment to malfunction and cause an accident.

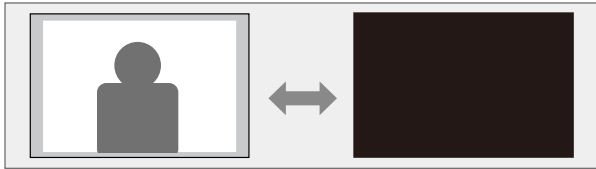

- You may not be able to connect depending on the standard and type of device.
- Even when connecting within the specified communication distance, connections can be lost due to the status of the signal.
- The communication method for Bluetooth uses the same frequency (2.4 GHz) as wireless LAN (IEEE802.11b/g/n) or microwave ovens. Therefore, if these devices are used at the same time, radio wave interference may occur, the audio may be interrupted, or communication may not be possible. If you do need to use these devices at the same time, make sure there is enough distance between them and the Bluetooth device.

When you want to enjoy the sound only from the projector, you can temporarily turn off the projected image.



- 1** Press the  button on the control panel or remote control. The light source turns off and the projected image is interrupted.
- 2** To turn the image back on, press  again.

When an audio/video source that meets the HDMI CEC standard is connected to the projector's HDMI port, you can use the projector's remote control to control certain features of the linked device.

► **Related Links**

- "Operating Connected Devices Using the HDMI CEC Features" [p.42](#)

Operating Connected Devices Using the HDMI CEC Features

You can control connected audio/video devices using the HDMI CEC features.



- You must also configure the connected device. See the documentation supplied with the device for more information.
- Some connected devices or functions of those devices may not operate properly even if they meet the HDMI CEC standard. See the documentation supplied with the device for more information.
- Use a cable that supports the HDMI standard.

1 Press the  button on the remote control.

2 Select the **Settings** menu and press the [Enter] button.

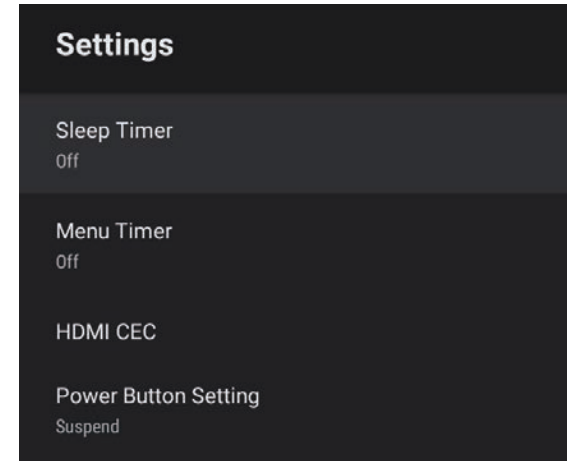

3 Select **HDMI CEC** and press [Enter].

4 Set **HDMI CEC** to **On**.

5 Adjust the following **HDMI CEC** settings as necessary.

- To automatically turn off the connected device when you turn off the projector, set **Device Auto Power Off** to **On**.
- To automatically switch the language settings of the connected device according to the projector's language settings, set **Auto Language Change** to **On**.
- To output audio to an HDMI ARC compatible AV system, set **HDMI2 ARC** to **On**.

6 Press  to exit the menus.

You can use the projector's remote control to control the linked device such as playback, stop, or adjust the volume.



» Related Links

- "Projector Feature Settings - Settings Menu" [p.53](#)

You can get the latest version of the projector firmware over a network.



When the latest projector firmware is available, a notification is automatically displayed on the screen. Follow the on-screen instructions to update the firmware.

- 1** Press the  button on the remote control.
- 2** Select  from the application list and press the [Enter] button.
- 3** Follow the on-screen instructions to update the firmware.

 **Caution**

Do not turn off the projector while updating the firmware.

You can reset all of the projector settings to their default values.



If you initialize the projector, all the information such as installed applications, Google account login information, and **Projector Settings** are deleted. Write down the settings you do not want to lose before performing initialization.

1 Press the  button on the remote control.

2 Select  at the top right of the Android TV™ home screen.

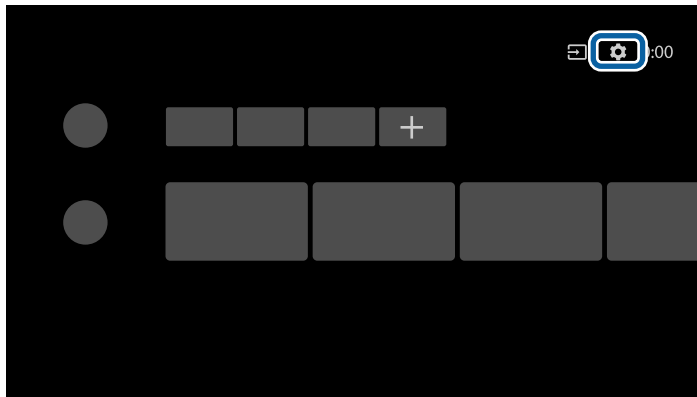

3 Select **Device Preferences** and select the reset menu.

4 Follow the on-screen instructions to start initializing the projector.

Adjusting the Menu Settings

Follow the instructions in these sections to access the projector menu system and change projector settings.



► **Related Links**

- "Using the Projector Settings" [p.47](#)
- "Image Quality Settings - Picture Menu" [p.48](#)
- "Sound Quality Settings - Sound Menu" [p.50](#)
- "Projector Feature Settings - Display Menu" [p.52](#)
- "Projector Feature Settings - Settings Menu" [p.53](#)

You can use the projector's menus to adjust the settings that control how your projector works. The projector displays the menus on the screen.

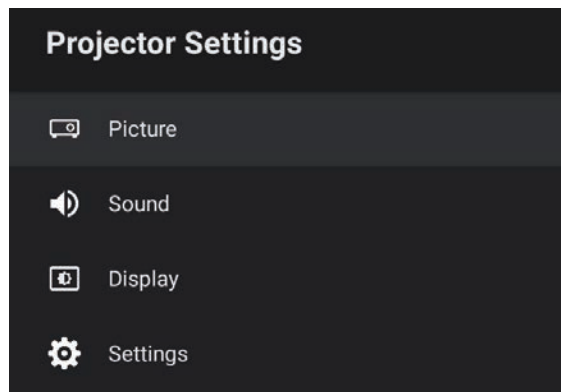
- 1** Press the  button on the remote control.
You see the **Projector Settings** on the screen.



- 2** Press the up or down arrow buttons to move through the menus listed on the screen.
- 3** To change settings in the displayed menu, press the [Enter] button.
- 4** Press the up or down arrow button to move through the settings.
- 5** Change the settings using the buttons as necessary.
- 6** When you finish changing settings on a menu, press .
- 7** Press  to exit the menus.

Settings on the **Picture** menu let you adjust the quality of your image for the input source you are currently using.

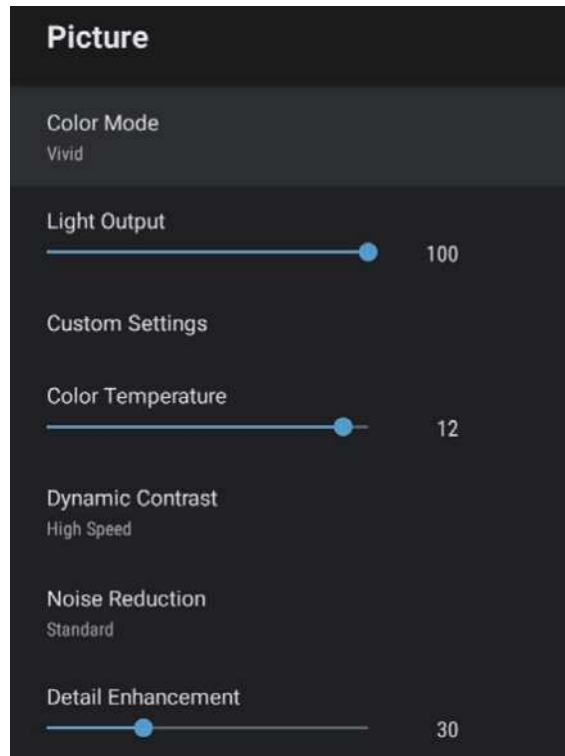

Setting	Options	Description
	Contrast	Adjusts the difference between light and dark areas of the image.
	Saturation	Adjusts the intensity of the image colors.
	Tint	Adjusts the balance of green to magenta tones in the image.
	Sharpness	Adjusts the sharpness or softness of the image for each Color Mode.
Color Temperature	Varying levels available	Sets the color temperature according to the color mode you selected. Higher values tint the image blue and lower values tint the image red.
Dynamic Contrast	High Speed Normal Off	Adjusts the projected luminance based on the image brightness for each Color Mode.
Noise Reduction	Strong Standard Weak Off	Reduces flickering in analog images. Select the intensity of the Noise Reduction.
Detail Enhancement	Varying levels available	Creates a more emphatic texture and material feel of the image for each Color Mode.
Aspect Ratio	Normal Full Zoom	Sets the aspect ratio (width-to-height ratio) for the input source.
HDMI Video Range	Auto Full Limited	Sets the video range to match the setting of the device connected to the HDMI port.

Setting	Options	Description
Color Mode	Dynamic Vivid Bright Cinema Cinema Natural	Selects the color mode suitable for the contents you are projecting.
Light Output	Varying levels available	Adjusts the brightness of the light source for each Color Mode.
Custom Settings	Brightness	Lightens or darkens the overall image.

» **Related Links**

- "Adjusting Image Quality (Color Mode)" [p.30](#)
- "Available Color Modes" [p.31](#)
- "Adjusting Image Quality in Detail" [p.33](#)
- "Turning On Automatic Luminance Adjustment" [p.32](#)

- "Adjusting the Light Source Brightness" [p.34](#)

Settings on the **Sound** menu provide optimum sound for a variety of image types. You can select the mode designed to match your image, or experiment with the available modes.

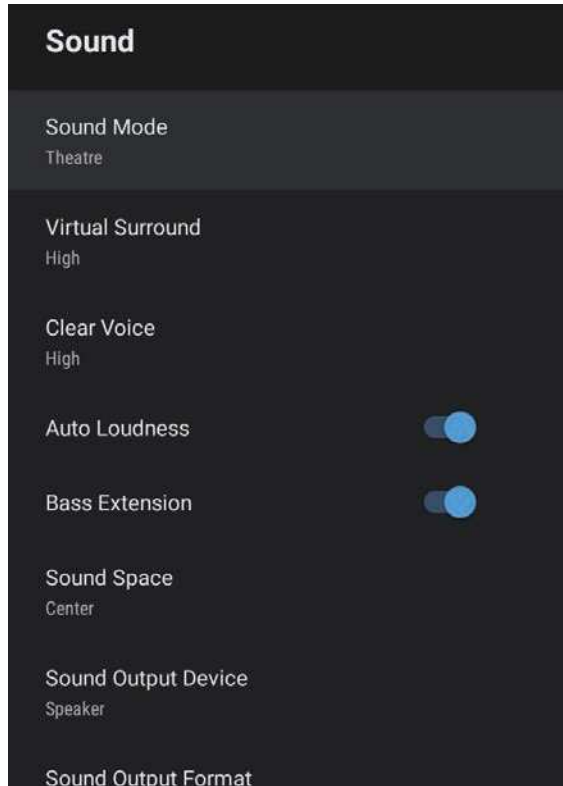

Setting	Options	Description
Virtual Surround	High Low Off	Adjusts the strength of the surround effect. This setting is saved for each Sound Mode.
Clear Voice	High Low Off	Adjusts the voice so that it can be heard clearly. This setting is saved for each Sound Mode.
Auto Loudness	On Off	Even when playing at low volumes, this automatically corrects the balance between high and low tones in the audio so that they are not out of balance.
Bass Extension	On Off	Emphasizes the bass levels to reproduce a powerful bass.
Sound Space	Right Center Left	Adjusts the sound quality to suit your viewing position.
Sound Output Device	Speaker ARC	Selects the sound output device. Speaker: Outputs sound from the projector's speakers. ARC: Outputs sound from an ARC compatible AV system. Connect an HDMI cable to the projector's HDMI2 (ARC) port.
Sound Output Format	PCM Auto	Selects the sound output format when you output audio to an external audio device. PCM: Outputs sound in PCM format (2 ch). Auto: Outputs higher quality sound. This projector supports the following audio codecs: <ul style="list-style-type: none"> • PCM (2 ch) • AC-3 (up to 5.1 ch) • DTS (up to 5.1 ch) If sound is not output correctly, select PCM .

Setting	Options	Description
Sound Mode	Theatre TV Studio Stadium Concert Karaoke Mode	Select your favorite mode for sound output from the projector's speaker system according to the playback contents.

Setting	Options	Description
Audio Output Latency	Varying levels available	<p>Adjusts the audio latency. If the audio is fast, select a higher value.</p> <p>This item is only available for the following types of audio.</p> <ul style="list-style-type: none">• audio output from the projector's speaker• audio output from the HDMI2 (ARC) port• audio output from the Optical Out port

► Related Links

- "Adjusting the Sound Settings (Sound Mode)" [p.36](#)

Settings on the **Display** menu provide correction methods to properly project your image.

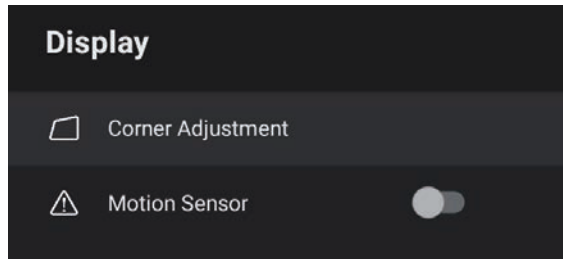

Setting	Options	Description
Corner Adjustment	-	Corrects image shape and alignment using an on-screen display.
Motion Sensor	On Off	Select On to automatically reduce the brightness of the light source for safety when someone comes close to the projector light while projecting.

» Related Links

- ["Image Shape" p.25](#)

Options on the **Settings** menu let you customize various projector features.

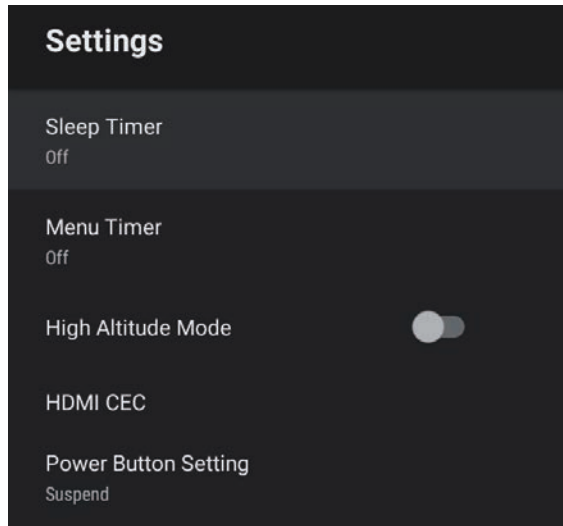

Setting	Options	Description
		<p>HDMI CEC: Select On to control the connected audio/video device using the projector's remote control.</p> <p>When this is set to On, the projector automatically turns on when you turn on the connected device, or when you start playback on the connected device.</p>
		<p>Device Auto Power Off: Select On to automatically turn off the connected audio/video device when you turn off the projector.</p>
		<p>Auto Language Change: Select On to automatically switch the language settings of the connected audio/video device according to the projector's language settings.</p>
		<p>HDMI2 ARC: Select On to enable HDMI ARC on the HDMI2 (ARC) port.</p>
Power Button Setting	Suspend Shutdown	<p>Sets the operation performed by the projector when you press the power button.</p> <p>Suspend: Starts the projector quickly from standby mode.</p> <p>Shutdown: Minimizes power consumption in standby mode. However, it takes longer to start the projector than when in Suspend mode.</p>

Setting	Options	Description
Sleep Timer	0 to 120 minutes	Sets the interval of time before the projector turns off automatically.
Menu Timer	0 to 240 seconds	Sets the interval of inactivity before closing the projector's menu automatically.
High Altitude Mode	On Off	Regulates the projector's operating temperature at altitudes above 1,500 m.
HDMI CEC	CEC Control	Enables CEC Control features when an audio/video device that meets the HDMI CEC standard is connected to the projector's HDMI port.

» **Related Links**

- "HDMI CEC Features" [p.42](#)

Maintaining the Projector

Follow the instructions in these sections to maintain your projector.

► **Related Links**

- "Projector Maintenance" [p.55](#)
- "Cleaning the Projection Window" [p.56](#)
- "Cleaning the Obstacle Sensor and Motion Sensor" [p.57](#)
- "Cleaning the Projector Case" [p.58](#)
- "Air Filter and Vent Maintenance" [p.59](#)

You may need to clean the projection window, obstacle sensor, and motion sensor periodically, and clean the air filter and air vents to prevent the projector from overheating due to blocked ventilation.

The only parts you should replace are the air filter and remote control batteries. If any other part needs replacing, contact Epson or an authorized Epson servicer.

Warning

Before cleaning any part of the projector, turn it off and unplug the power cord. Never open any cover on the projector, except as specifically explained in this manual. Dangerous electrical voltages in the projector can injure you severely.

Clean the projection window periodically, or whenever you notice dust or smudges on the surface. To remove dust or smudges, gently wipe the projection window with lens-cleaning paper.

 **Warning**

Do not use a lens cleaner that contains flammable gas. The high heat generated by the projector may cause a fire.

Attention

Do not use glass cleaner or any harsh materials to clean the projection window and do not subject the projection window to any impacts; otherwise, it could be damaged.

Clean the projector's obstacle sensor and motion sensor periodically, or if you see a message telling you to remove any obstacles that are interfering with the projection area. To remove dust or smudges, gently wipe the lens with lens-cleaning paper.

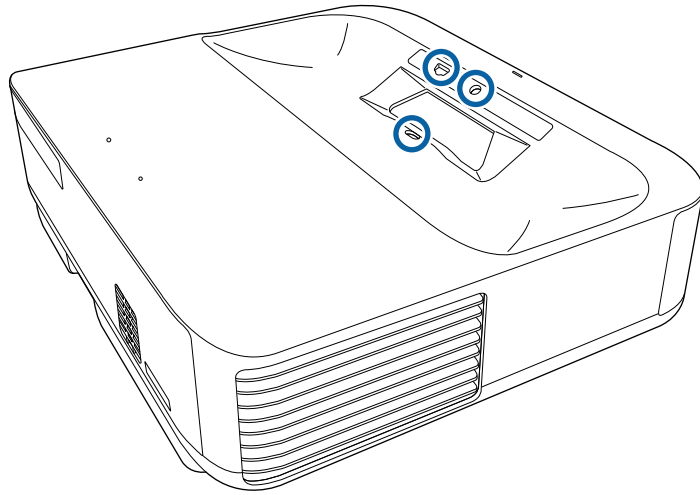

Warning

Do not use a lens cleaner that contains flammable gas to clean the obstacle sensor and motion sensor. The high heat generated by the projector may cause a fire.

Attention

Do not use glass cleaner or any harsh materials to clean the sensors and do not subject the sensors to any impacts. Damage to the surface of the sensors may cause malfunctions.

Before cleaning the projector case, turn off the projector and unplug the power cord.

- To remove dust or dirt, use a soft, dry, lint-free cloth.
- To remove stubborn dirt, use a soft cloth moistened with water and mild soap. Do not spray liquid directly on the projector.

Attention

Do not use wax, alcohol, benzene, paint thinner, or other chemicals to clean the projector case. These can damage the case. Do not use canned air, or the gases may leave a flammable residue.

Regular filter maintenance is important to maintain your projector. Clean the air filter when a message appears telling you the temperature inside the projector has reached a high level. It is recommended that you clean these parts over a 12,000 hour period. Clean them more often than this if you use the projector in a environment that is dustier than expected. (Assuming the projector is used in an atmosphere in which airborne particulate matter is less than 0.04 to 0.2 mg/m³.)

Attention

If regular maintenance is not performed, your Epson projector will notify you when the temperature inside the projector has reached a high level. Do not wait until this warning appears to maintain your projector filter as prolonged exposure to high temperatures may reduce the life of your projector.

► Related Links

- "Cleaning the Air Filter" [p.59](#)
- "Replacing the Air Filter" [p.60](#)

Cleaning the Air Filter

You need to clean the projector's air filters in the following situations:

- The filter or vents get dusty.

- 1** Turn off the projector and unplug the power cord.
- 2** Slide the air filter cover latch and open the air filter cover.

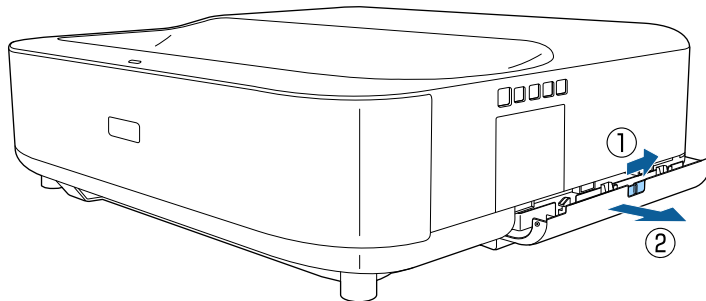

- 3** Pull the air filter out of the projector.

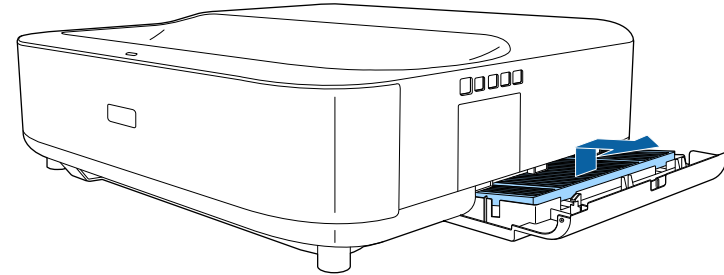

- 4** Vacuum the front of the air filter (the side with the tabs) to remove any remaining dust.

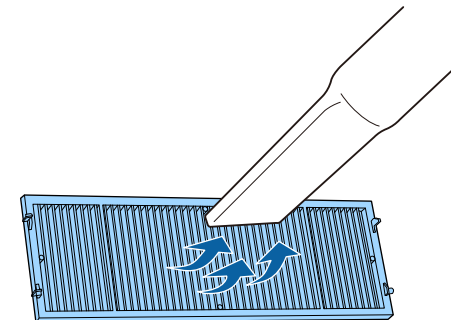

Attention

- Do not rinse the air filter in water, or use any detergent or solvent to clean it.
- Do not use canned air. The gases may leave a flammable residue or push dust and debris into the projector's optics or other sensitive areas.

- 5** Place the air filter with the four tabs facing down as shown.

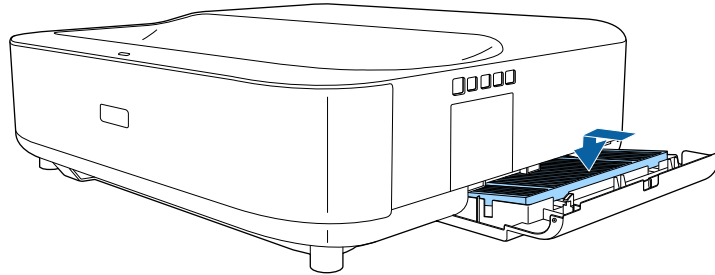

Attention

Do not force the air filter cover to close with the tabs on the air filter facing up. Doing so could damage the projector.

- 6** Close the air filter cover until it clicks into place.

- 2** Slide the air filter cover latch and open the air filter cover.

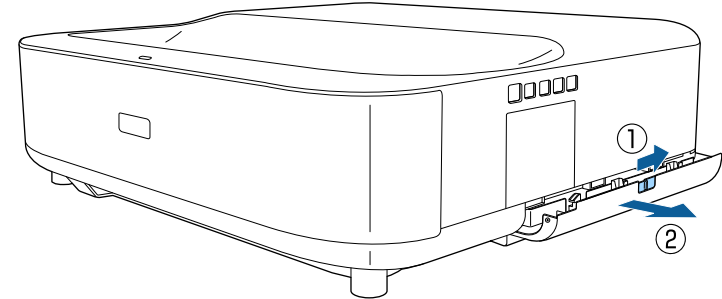

- 3** Pull the air filter out of the projector.

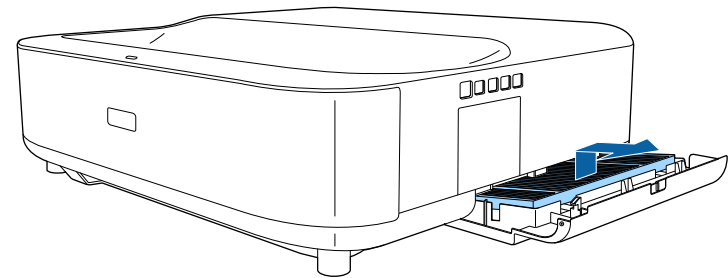

Replacing the Air Filter

You need to replace the air filter in the following situations:

- The air filter is torn or damaged.

- 1** Turn off the projector and unplug the power cord.



Dispose of used air filters according to local regulations.

- Filter frame: Polypropylene
- Filter: Polypropylene, PET

- 4** Place the new air filter with the four tabs facing down as shown.

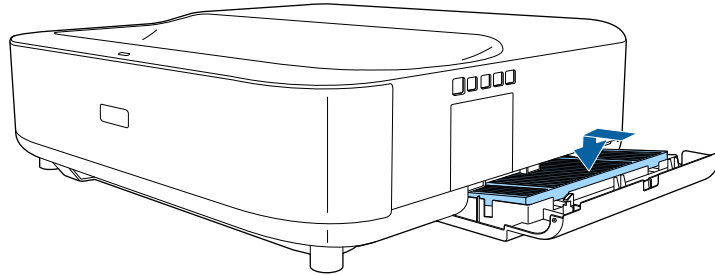

Attention

Do not force the air filter cover to close with the tabs on the air filter facing up. Doing so could damage the projector.

- 5** Close the air filter cover until it clicks into place.

» **Related Links**

- "Replacement Parts" [p.77](#)

Solving Problems

Check the solutions in these sections if you have any problems using the projector.

► Related Links

- ["Projection Problems" p.63](#)
- ["Projector Indicator Status" p.64](#)
- ["Solving Projector Power-On or Power-Off Problems" p.66](#)
- ["Solving Image Problems" p.67](#)
- ["Solving Sound Problems" p.70](#)
- ["Solving Remote Control Operation Problems" p.72](#)
- ["Solving HDMI CEC Problems" p.73](#)
- ["Solving Wi-Fi Network Problems" p.74](#)
- ["Solving Android TV™ Problems" p.75](#)

If the projector is not working properly, turn it off, unplug it, and then plug it back in and turn it on.

If this does not solve the problem, check the following:

- The indicators on the projector may indicate the problem.
- The solutions in this manual can help you solve many problems.

If none of these solutions help, contact Epson for technical support.



After repairing the projector, Epson may return the projector to you in its initial status. Make sure you make a note of the account information of each online service before you contact your local dealer or the nearest Epson repair center.

The indicators on the projector indicate the projector status and let you know when a problem occurs. Check the status and color of the indicators and then refer to this table for a solution.

 If the indicators display a pattern not listed in the table below, turn the projector off, unplug it, and contact Epson for help.

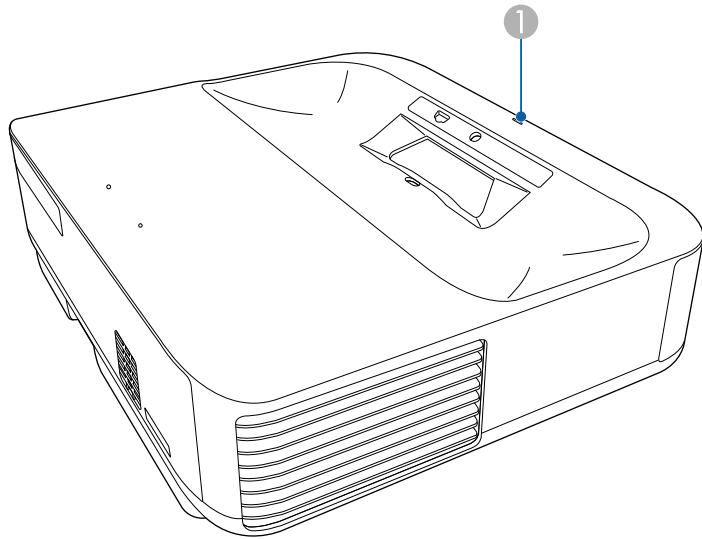

① Status indicator

Projector status

Indicator status	Problem and solutions
Lit blue	Normal operation.
Flashing blue	Warming up, shutting down, or initializing the projector. Remote control operations may be disabled when the indicator is flashing blue.

Indicator status	Problem and solutions
Off	Standby or sleep mode. When you press the power button, projection starts.
Lit orange	Projector has overheated and turned off. Leave it turned off to cool down for 5 minutes. <ul style="list-style-type: none"> • Make sure that the vents and air filter are not clogged with dust or obstructed by nearby objects. • Make sure the environmental temperature is not too hot. • Clean or replace the air filter. • If operating the projector at high altitude, set the High Altitude Mode setting to On in the projector's menu. <ul style="list-style-type: none"> ☛ Settings > High Altitude Mode • If the problem persists, unplug the projector and contact Epson for help.
	Obstacle detection warning. A beep sounds, and the message "Playback has been stopped for safety reasons. Move away from the lens or remove any obstacles around the lens." is displayed. The brightness of the light source is reduced. <ul style="list-style-type: none"> • Make sure that there are no obstacles interfering with the projection window. Remove any obstacles. • Clean the obstacle sensor if there are no obstacles. The projector turns off automatically if no action is taken.
	Movement detection warning. A beep sounds, and the message "Playback has been stopped for safety reasons. Move away from the lens or remove any obstacles around the lens." is displayed. The brightness of the light source is reduced. <ul style="list-style-type: none"> • Make sure that there are no one looking into the projection window. Move away from the projection window. • Clean the motion sensor if there is no one near the projection window.

Indicator status	Problem and solutions
	Laser warning. Turn the projector off, unplug it, and contact Epson for help.
Flashing orange	Laser has a problem. Turn the projector off, unplug it, and contact Epson for help.
	A fan or sensor has a problem. Turn the projector off, unplug it, and contact Epson for help.
	Obstacle detection error. If there are no obstacles interfering with the projection window, turn the projector off, unplug it, and contact Epson for help.
	Internal projector error. Turn the projector off, unplug it, and contact Epson for help.

» Related Links

- "Projector Feature Settings - Settings Menu" [p.53](#)
- "Cleaning the Air Filter" [p.59](#)
- "Replacing the Air Filter" [p.60](#)

Check the solutions in these sections if the projector does not turn on when you press the power button or it turns off unexpectedly.

» Related Links

- "Solving Projector Power Problems" [p.66](#)
- "Solving Projector Shutdown Problems" [p.66](#)

Solving Projector Power Problems

If the projector does not turn on when you press the power button, try the following steps until the problem is solved.

- 1** Make sure the power cord is securely connected to the projector and to a working electrical outlet.
- 2** If you are using the remote control, check the batteries of the remote control.
- 3** The power cord may be defective. Disconnect the cord and contact Epson for help.

» Related Links

- "Turning On the Projector" [p.23](#)
- "Installing Batteries in the Remote Control" [p.18](#)

Solving Projector Shutdown Problems

If the projector's light source turns off unexpectedly, try the following steps until the problem is solved.

- 1** The projectors may have entered sleep mode after the interval of time specified in **Sleep Timer** in the projector's **Settings** menu has passed. Press the power button on the control panel or remote control to wake the projector.



After waking the projector, **Sleep Timer** is automatically set to **Off**.

- 2** When the status indicator is lit orange, the projector has overheated and turned off.



The cooling fans may run in standby status depending on the projector settings. Also, when the projector wakes from standby status, the fans may cause an unexpected noise. This is not a malfunction.

- 3** Check the following items:
 - Make sure that there are no obstacles interfering with the projection window. Remove any obstacles.
 - Clean the obstacle sensor if there are no obstacles.

» Related Links

- "Projector Feature Settings - Settings Menu" [p.53](#)

Check the solutions in these sections if you have any problems with projected images.

► Related Links

- "Solving Missing Image Problems" [p.67](#)
- "Adjusting an Image that is not Rectangular" [p.67](#)
- "Adjusting a Fuzzy or Blurry Image" [p.68](#)
- "Fixing Partial Image Problems" [p.68](#)
- "Adjusting an Image that Contains Noise or Static" [p.68](#)
- "Adjusting an Image with Incorrect Brightness or Colors" [p.69](#)

Solving Missing Image Problems

If no image is displayed, try the following steps until the problem is solved.

1 Check the projector's status:

- Press the  button on the control panel or remote control to see if the image was temporarily turned off.
- Check the status indicator to confirm that the projector is in normal operating status.
- Press the projector's power button to wake it from standby or sleep mode.

☛ **Settings > Sleep Timer**

2 Check the cable connection:

- Make sure all necessary cables are securely connected and the power is on for the projector.
- Connect the video source directly to the projector.
- Replace the HDMI cable with the shorter one.

3 Check the status of your video source:

- Make sure the connected device meets the HDMI CEC standard. See the documentation supplied with the device for more information.

- If you are projecting from a laptop computer, make sure it is set up to display on an external monitor.

4 Check the following items:

- You need an Internet connection to view online content. Make sure your Wi-Fi is on.
- Set the CEC function for the connected device again and restart the device.
- Make sure the computer's display resolution does not exceed the projector's resolution and frequency limits. If necessary, select a different display resolution for your computer. (See your computer manual for details.)
- Resets all of the projector settings to their default values.

► Related Links

- "Projector Feature Settings - Settings Menu" [p.53](#)

Adjusting an Image that is not Rectangular

If the projected image is not evenly rectangular, try the following steps until the problem is solved.

1 Place the projector directly in front of the center of the screen, facing it squarely, if possible.

2 Press the button on the remote control to perform **Corner Adjustment** correction.

► Related Links

- "Correcting the Image Shape with Corner Adjustment" [p.25](#)

Adjusting a Fuzzy or Blurry Image

If the projected image is fuzzy or blurry, try the following steps until the problem is solved.

- 1 Adjust the image focus using the focus lever.
- 2 Check the following items:
 - Position the projector close enough to the screen.
 - Position the projector so the keystone adjustment angle is not so wide that it distorts the image.

- 3 Clean the projection window.



To avoid condensation on the lens after bringing the projector in from a cold environment, let the projector warm up to room temperature before using it.

- 4 Adjust the **Sharpness** setting in the projector's **Picture** menu to improve image quality.

☛ **Picture > Custom Settings > Sharpness**

- 5 If you are projecting from a computer, use a lower resolution or select a resolution that matches the projector's native resolution.

» Related Links

- "Image Quality Settings - Picture Menu" [p.48](#)
- "Focusing the Image Using the Focus Lever" [p.26](#)
- "Cleaning the Projection Window" [p.56](#)

Fixing Partial Image Problems

If only a partial computer image is displayed, try the following steps until the problem is solved.

- 1 If **Aspect Ratio** in the **Picture** menu is set to **Zoom**, change it to **Normal**.
- 2 Check your computer display settings to disable dual display and set the resolution within the projector's limits. (See your computer manual for details.)

» Related Links

- "Projector Feature Settings - Display Menu" [p.52](#)

Adjusting an Image that Contains Noise or Static

If the projected image contains electronic interference (noise) or static, try the following steps until the problem is solved.

- 1 Check the cables connecting your video source to the projector. They should be:
 - Separated from the power cord to prevent interference
 - Securely connected at both ends
 - Not connected to an extension cable

- 2 If you adjusted the image shape using the projector controls, try decreasing the **Sharpness** setting in the projector's **Picture** menu to improve image quality.

☛ **Picture > Custom Settings > Sharpness**

- 3 If you connected an extension power cable, try projecting without it to see if it caused interference in the signal.

- 4 Select a computer video resolution and refresh rate that are compatible with the projector.

» **Related Links**

- "Image Quality Settings - Picture Menu" [p.48](#)

Adjusting an Image with Incorrect Brightness or Colors

If the projected image is too dark or bright, or the colors are incorrect, try the following steps until the problem is solved.

- 1 Try different color modes for your image and environment by selecting the **Color Mode** setting in the projector's **Picture** menu.
- 2 Check your video source settings.
- 3 Adjust **Custom Settings** and **Color Temperature** in the **Picture** menu for the current input source.
- 4 Make sure you selected the correct **HDMI Video Range** setting in the projector's **Picture** menu, if available for your image source.
- 5 Make sure all the cables are securely connected to the projector and your video equipment. If you connected long cables, try connecting shorter cables.
- 6 Position the projector close enough to the screen.

» **Related Links**

- "Image Quality Settings - Picture Menu" [p.48](#)



Check the solutions in these sections if you have any problems with projected sound.

» Related Links

- "Solving Missing or Low Audio Problems" [p.70](#)
- "Solving Bluetooth Speaker Mode Problems" [p.70](#)

Solving Missing or Low Audio Problems

If there is no sound or the volume is too low, try the following steps until the problem is solved.

- 1** Adjust the projector's volume settings using the  or  button on the control panel or remote control.
- 2** Check the cable connection between the projector and your video source.
- 3** Check the following settings on your video equipment:
 - Check your video source to make sure the volume is turned up and the audio output is set for the correct source.
 - When you are connecting the projector to a Mac using an HDMI cable, make sure your Mac supports audio through the HDMI port.
- 4** If you want to output audio from the projector's speaker, try the following solutions:
 - Set **Sound Output Device** to **Speaker** in the **Sound** menu.
 - Set **Sound Output Format** to **PCM** in the **Sound** menu.
- 5** If you want to output audio to an external audio device using an HDMI cable, try the following solutions:
 - Make sure the HDMI cable is connected to the projector's HDMI2 (ARC) port.
 - Set **HDMI CEC** to **On** in the **Settings** menu.

- Set **HDMI2 ARC** to **On** in the **Settings** menu.
- Set **Sound Output Device** to **ARC** in the **Sound** menu.
- Set **Sound Output Format** to **PCM** in the **Sound** menu.
- Make sure the HDMI cable is compliant with HDMI ARC.



When outputting audio to an external audio device that does not support HDMI ARC using an HDMI cable, set **HDMI CEC** to **Off** in the **Settings** menu.

- 6** If you want to output audio to an external audio device using an optical digital audio cable, set **Sound Output Format** to **PCM** in the **Sound** menu.

» Related Links

- "Sound Quality Settings - Sound Menu" [p.50](#)

Solving Bluetooth Speaker Mode Problems

If you cannot connect a Bluetooth audio device to the projector, try the following solutions.

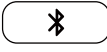
- 1** Press the  button on the control panel or remote control to enter **Bluetooth Speaker Mode**.
- 2** Select **Projector** from the available Bluetooth device list displayed on your device.
- 3** Make sure only one Bluetooth device is connected to the projector. You cannot connect multiple Bluetooth audio devices to the projector at the same time.
- 4** Make sure the device meets the projector's Bluetooth specifications.

5 Check the following items:

- Check for obstacles between the Bluetooth audio device and the projector, and change their positions to improve communication.
- Make sure the connected Bluetooth audio device is within the specified communication distance.
- Avoid using the projector near wireless networks, microwave ovens, 2.4 GHz cordless phones, or other devices that use the 2.4 GHz frequency band. These devices can interfere with the signal between the projector and the Bluetooth audio device.

» **Related Links**

- ["Bluetooth Specifications" p.39](#)
- ["Using the Projector as a Bluetooth Speaker" p.39](#)

If the projector does not respond to remote control commands, try the following steps until the problem is solved.



If you lose the remote control, you can order another one from Epson.

- 1** Check that the remote control batteries are installed correctly and have power. If necessary, replace the batteries.
- 2** Check to see if a button on the remote control is stuck down, causing it to enter sleep mode. Release the button to wake the remote control up.
- 3** If the image is projected from the projector, make sure you are operating the remote control within the reception angle and range of the projector.
- 4** Check the status indicator to confirm that the projector is in normal operating status.
- 5** Strong fluorescent lighting, direct sunlight, or infrared device signals may be interfering with the projector's remote receivers. Dim the lights or move the projector away from the sun or interfering equipment.
- 6** If the pairing screen is displayed, perform pairing again by holding down the [Enter] button and  button on the remote control at the same time for about three seconds.

» Related Links

- "Remote Control Operation" [p.19](#)
- "Projector Indicator Status" [p.64](#)
- "Installing Batteries in the Remote Control" [p.18](#)

If you cannot operate the connected devices from the projector, try the following steps until the problem is solved.

- 1** Make sure the cable meets the HDMI CEC standard.
- 2** Make sure the connected device meets the HDMI CEC standard. See the documentation supplied with the device for more information.
- 3** Set **HDMI CEC** to **On** in the **Settings** menu.
☛ **Settings > HDMI CEC > CEC Control**
- 4** Make sure all the cables are securely connected to the projector and your video equipment.



Make sure you connect the HDMI cable to the projector's HDMI2 (ARC) port.

- 5** Make sure the connected devices are turned on and in standby status. See the documentation supplied with the device for more information.
- 6** If you connect a new device or change the connection, set the CEC function for the connected device again and restart the device.

» Related Links

- "Projector Feature Settings - Settings Menu" [p.53](#)
- "Operating Connected Devices Using the HDMI CEC Features" [p.42](#)

If you cannot connect to a Wi-Fi network, try the following solutions.

- 1** Make sure your Wi-Fi router and modem are working properly. Rebooting these devices may solve the network connection problem.
- 2** Check for obstacles between the Wi-Fi router and the projector, and change their positions to improve communication.
- 3** You can check the network settings from the menu displayed when you press  at the top right of the Android TV™ home screen.
- 4** If you initialize the projector, you need to select the network settings again on the initial setup screen.

► Related Links

- "Initializing the Projector" [p.45](#)

See the following page if you have any problems when watching the Android TV™.

<https://support.google.com/androidtv/>

Appendix

Check these sections for the technical specifications and important notices about your projector.

► **Related Links**

- "Optional Accessories and Replacement Parts" [p.77](#)
- "Screen Size and Projection Distance" [p.78](#)
- "Supported Monitor Display Resolutions" [p.79](#)
- "Projector Specifications" [p.80](#)
- "External Dimensions" [p.81](#)
- "List of Safety Symbols and Instructions" [p.82](#)
- "Laser Safety Information" [p.84](#)
- "Glossary" [p.86](#)
- "Notices" [p.87](#)

The following optional accessories and replacement parts are available. Please purchase these products as and when needed.

The following list of optional accessories and replacement parts is current as of: August 2020.

Details of accessories are subject to change without notice and availability may vary depending on the country of purchase.

» **Related Links**

- "Screens" [p.77](#)
- "Replacement Parts" [p.77](#)

Screens

Ultra Short Throw Screen ELPSC35 (100")

Ultra Short Throw Screen ELPSC36 (120")

Screens to be installed on a wall. (Aspect ratio 16:9)

Replacement Parts

Air filter ELPAF60

Use as a replacement for used air filters.

» **Related Links**

- "Replacing the Air Filter" [p.60](#)

Check the table here to determine how far to place the projector from the screen based on the size of the projected image.

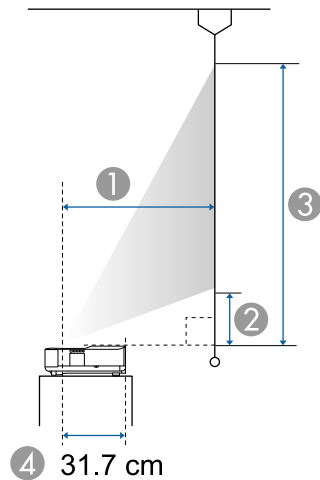

- ① Projection distance (cm)
- ② Distance from the projector to the bottom of the screen (cm)
- ③ Distance from the projector to the top of the screen (cm)
- ④ Distance from the center of the lens to the rear of the projector (cm)

4:3 screen size		①	②	③
50"	102 × 76	35.0	12.8	89.0
55"	112 × 84	38.7	14.7	98.5
60"	122 × 91	42.4	16.6	108.0
65"	132 × 99	46.0	18.5	117.5
70"	142 × 107	49.7	20.4	127.0
75"	152 × 114	53.4	22.3	136.6
80"	163 × 122	57.1	24.2	146.1
85"	173 × 130	60.7	26.1	155.6
90"	183 × 137	64.4	28.0	165.1
98"	199 × 149	70.3	31.0	180.4

16:10 screen size		①	②	③
60"	129 × 81	37.2	13.9	94.7
65"	140 × 88	40.5	15.6	103.1
70"	151 × 94	43.7	17.3	111.5
75"	162 × 101	47.0	18.9	119.9
80"	172 × 108	50.2	20.6	128.3
85"	183 × 114	53.5	22.3	136.7
90"	194 × 121	56.7	24.0	145.1
100"	215 × 135	63.2	27.3	162.0
111"	239 × 149	70.3	31.0	180.5

16:9 screen size		①	②	③
61"	135 × 76	34.9	12.7	88.7
70"	155 × 87	40.3	15.5	102.7
75"	166 × 93	43.3	17.0	110.4
80"	177 × 100	46.3	18.6	118.2
90"	199 × 112	52.3	21.7	133.8
100"	221 × 125	58.3	24.8	149.3
110"	244 × 137	64.3	27.9	164.9
120"	266 × 149	70.3	31.0	180.5

The table here lists the compatible refresh rate and resolution for each compatible video display format.

HDMI Port Input Signals

Signal	Refresh rate (Hz)	Resolution (dots)	Color space
VGA	60	640 × 480	RGB*
SDTV (480i/480p)	59.94	720 × 480	4:2:2/4:4:4/RGB
SDTV (576i/576p)	50	720 × 576	4:2:2/4:4:4/RGB
HDTV (720p)	50/59.94/60	1280 × 720	4:2:2/4:4:4/RGB
HDTV (1080i)	50/59.94/60	1920 × 1080	4:2:2/4:4:4/RGB
HDTV (1080p)	23.98/24/29.97/30/50/59.94/60	1920 × 1080	4:2:2/4:4:4/RGB
4K (3840 × 2160)	23.98/24/25/29.97/30	3840 × 2160	4:2:2/4:4:4*/RGB*
	50/59.94/60		4:2:0*
4K (4096 × 2160)	23.98/24/25/29.97/30	4096 × 2160	4:2:2/4:4:4*/RGB*
	50/59.94/60		4:2:0*

* Supports 8 bit only.

The following signals support HDR10 and HLG.

Signal	Refresh rate (Hz)	Resolution (dots)	Color space**
1080p (1920 × 1080)	23.98/24/29.97/30/50/59.94/60	1920 × 1080	4:2:2/4:4:4/RGB
4K (3840 × 2160)	23.98/24/25/29.97/30	3840 × 2160	4:2:2
4K (4096 × 2160)	23.98/24/25/29.97/30	4096 × 2160	4:2:2

** Supports 10 and 12 bit only.

Product name	EH-LS300W/EH-LS300B
Dimensions	467 (W) × 133 (H) × 400 (D) mm (not including raised section)
LCD panel size	0.61"
Display method	Poly-silicon TFT active matrix
Resolution	2,073,600 pixels Full HD (1,920 (W) × 1,080 (H) dots) × 3
Focus adjustment	Manual
Light source	Laser diode
Light source output power	Up to 81 W
Wavelength	449 to 461 nm
Light source life *	Up to about 20,000 hours
Max. audio output	20 W
Speaker	2.1ch (Speaker × 2, Woofer × 1)
Power supply	100-240V AC±10% 50/60Hz 3.0 - 1.3 A
Power consumption (100 to 120 V area)	Operating power consumption: 292 W
Power consumption (220 to 240 V area)	Operating power consumption: 278 W
Standby power consumption	Communication On: 2.0 W Communication Off: 0.5 W
Operating altitude	Altitude 0 to 3,000 m
Operating temperature	Altitude of 0 to 2,286 m: 5 to +35°C (No condensation) Altitude of 2,287 to 3,000 m: 5 to +30°C (Humidity of 20 to 80%, No condensation)
Storage temperature	-10 to +60°C (Humidity of 10 to 90%, No condensation)
Mass	Approx. 7.2 kg

* Approximate time until the light source brightness decreases to half of its original value. (Assuming the projector is used in an atmosphere in which

airborne particulate matter is less than 0.04 to 0.2mg/m³. The estimated time varies depending on the projector usage and operating conditions.)

This product is also designed for IT power distribution system with phase-to-phase voltage 230V.

► **Related Links**

- "Connector Specifications" [p.80](#)

Connector Specifications

HDMI1 port	1	HDMI
HDMI2 (ARC) port	1	HDMI
USB-A port	1	USB connector (Type A)
Service port	1	USB connector (Mini-B)
Optical Out port	1	Optical digital audio connector (S/PDIF)

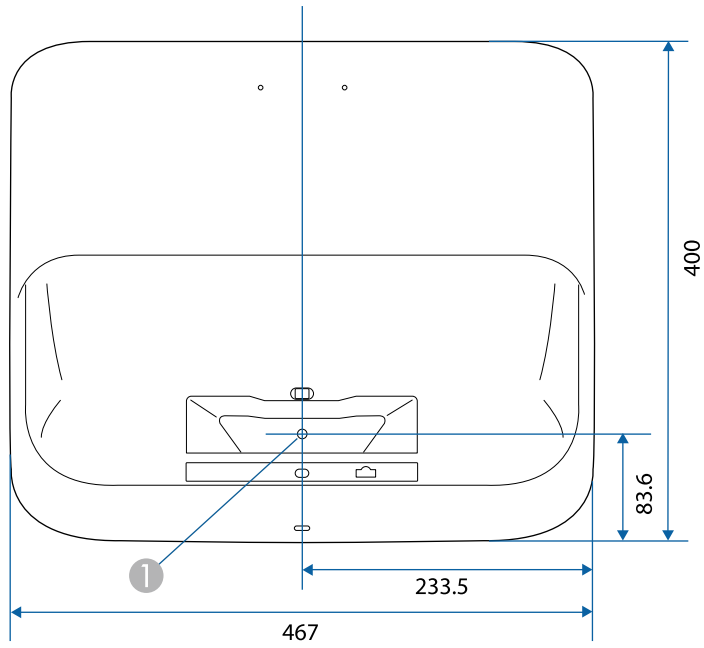



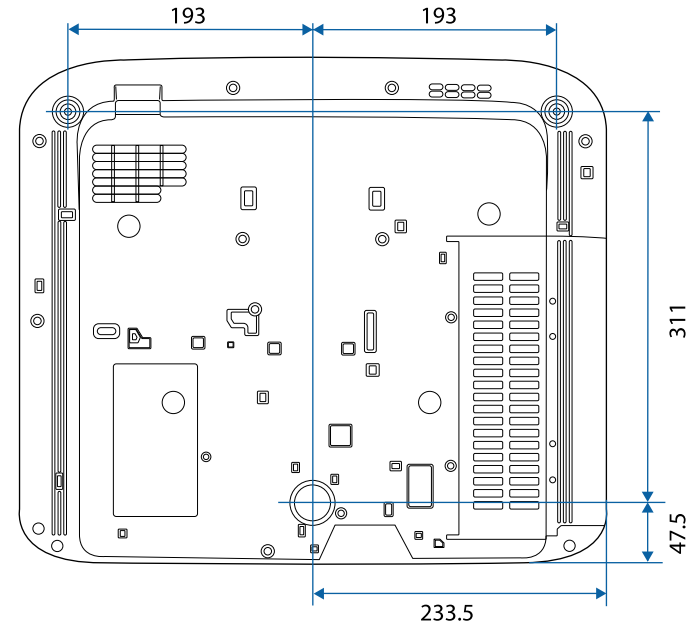













1 Center of the projection window













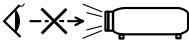

The unit in these illustrations is mm.

The following table lists the meaning of the safety symbols labeled on the equipment.

No.	Symbol mark	Approved standards	Description
1		IEC60417 No. 5007	"ON" (power) To indicate connection to the mains.
2		IEC60417 No. 5008	"OFF" (power) To indicate disconnection from the mains.
3		IEC60417 No. 5009	Stand-by To identify the switch or switch position by means of which part of the equipment is switched on in order to bring it into the stand-by condition.
4		ISO7000 No. 0434B, IEC3864-B3.1	Caution To identify general caution when using the product.
5		IEC60417 No. 5041	Caution, hot surface To indicate that the marked item can be hot and should not be touched without taking care.
6		IEC60417 No. 6042 ISO3864-B3.6	Caution, risk of electric shock To identify equipment that has risk of electric shock.
7		IEC60417 No. 5957	For indoor use only To identify electrical equipment designed primarily for indoor use.
8		IEC60417 No. 5926	Polarity of d.c. power connector To identify the positive and negative connections (the polarity) on a piece of equipment to which a d.c. power supply may be connected.

No.	Symbol mark	Approved standards	Description
9		—	The same as No. 8.
10		IEC60417 No. 5001B	Battery, general On battery powered equipment. To identify a device for instance a cover for the battery compartment, or the connector terminals.
11		IEC60417 No. 5002	Positioning of cell To identify the battery holder itself and to identify the positioning of the cell(s) inside the battery holder.
12		—	The same as No. 11.
13		IEC60417 No. 5019	Protective earth To identify any terminal which is intended for connection to an external conductor for protection against electric shock in case of a fault, or the terminal of a protective earth electrode.
14		IEC60417 No. 5017	Earth To identify an earth (ground) terminal in cases where neither the symbol No. 13 is explicitly required.
15		IEC60417 No. 5032	Alternating current To indicate on the rating plate that the equipment is suitable for alternating current only; to identify relevant terminals.
16		IEC60417 No. 5031	Direct current To indicate on the rating plate that the equipment is suitable for direct current only; to identify relevant terminals.

No.	Symbol mark	Approved standards	Description
17		IEC60417 No. 5172	Class II equipment To identify equipment meeting the safety requirements specified for Class II equipment according to IEC 61140.
18		ISO 3864	General prohibition To identify actions or operations that are prohibited.
19		ISO 3864	Contact prohibition To indicate injury that could occur due to touching a specific part of the equipment.
20		—	Never look into the optical lens while the projector is on.
21		—	To indicate that the marked item don't place anything on projector.
22		ISO3864 IEC60825-1	Caution, laser radiation To indicate the equipment has a laser radiation part.
23		ISO 3864	Disassembly prohibition To indicate a risk of injury, such as electric shock, if the equipment is disassembled.
24		IEC60417 No. 5266	Standby, partial standby To indicate that part of the equipment is in the ready status.
25		ISO3864 IEC60417 No. 5057	Caution, movable parts To indicate that you must keep away from movable parts according to protection standards.
26		IEC60417 No. 6056	Caution (Moving Fan Blades) As a safety precaution, stay away from the moving fan blades.

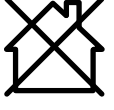
No.	Symbol mark	Approved standards	Description
27		IEC60417 No. 6043	Caution (Sharp Corners) To indicate sharp corners that should not be touched.
28		—	To indicate that looking into the lens while projecting is prohibited.
29		ISO7010 No. W027 ISO 3864	Warning, Optical radiation (such as UV, visible radiation, IR) Taking care to avoid injury to eyes and skin when in the vicinity of optical radiation.
30		IEC60417 No. 5109	Not to be used in residential areas. To identify electrical equipment which is not suitable for a residential area.

This projector is a Class 1 laser product that complies with the IEC/EN60825-1:2014 international standard for lasers.

Follow these safety instructions when using the projector.

Warning

- Do not open the projector's case. The projector contains a high-powered laser.
- Possibly hazardous optical radiation emitted from this product. Do not look at operating light source. Eye injury may result.

Caution

Do not disassemble the projector when disposing of it. Dispose according to your local or national laws and regulations.



The projector uses a laser as the light source. The laser has the following characteristics.

- Depending on the surroundings, the brightness of the light source may decline. The brightness declines a lot when the temperature gets too high.
- The brightness of the light source declines the longer it is used. You can change the relationship between usage time and decline in brightness settings.

▶ Related Links

- "Laser Warning Labels" [p.84](#)

Inside



Laser Warning Labels

Laser warning labels are attached on the projector.

Side

As with any bright source, do not stare into the beam, RG2 IEC/EN 62471-5:2015.

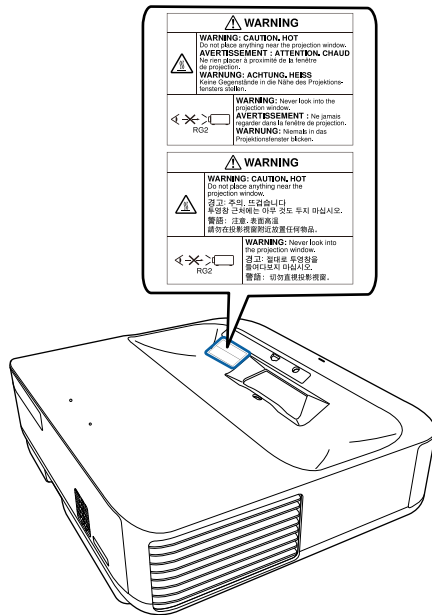

For North/South America

This projector is a Class 1 laser product that complies with the IEC/EN60825-1:2014 international standard for lasers. Follow these safety instructions when using the projector.

Complies with FDA performance standards for laser products except for conformance as a Risk Group 2 LIP as defined in IEC 62471-5: Ed. 1.0. For more information see Laser Notice No. 57, dated May 8, 2019.

This section briefly explains the difficult terms that are not explained in the text of this guide. For details, refer to other commercially available publications.

Aspect Ratio	The ratio between an image's length and its height. Screens with a horizontal:vertical ratio of 16:9, such as HDTV screens, are known as wide screens. SDTV and general computer displays have an aspect ratio of 4:3.
Contrast	The relative brightness of the light and dark areas of an image can be increased or decreased to make text and graphics stand out more clearly, or to make them appear softer. Adjusting this particular property of an image is called contrast adjustment.
Full HD	A screen size standard with a resolution of 1,920 (horizontal) × 1,080 (vertical) dots.
HDCP	HDCP is an abbreviation for High-bandwidth Digital Content Protection. It is used to prevent illegal copying and protect copyrights by encrypting digital signals sent over DVI and HDMI ports. Because the HDMI port on this projector supports HDCP, it can project digital images protected by HDCP technology. However, the projector may not be able to project images protected with updated or revised versions of HDCP encryption.
HDMI™	An abbreviation for High Definition Multimedia Interface. HDMI™ is a standard aimed at digital consumer electronics and computers. This is the standard by which HD images and multichannel audio signals are digitally transmitted. By not compressing the digital signal, the image can be transferred at the highest quality possible. It also provides an encryption function for the digital signal.
HDTV	An abbreviation for High-Definition Television that refers to high-definition systems which satisfy the following conditions: <ul style="list-style-type: none"> • Vertical resolution of 720p or 1080i or greater (p = Progressive, i = Interlace) • Screen aspect ratio of 16:9
Pairing	Register devices in advance when connecting with Bluetooth devices to ensure mutual communication.

Refresh Rate	The light-emitting element of a display maintains the same luminosity and color for an extremely short time. Because of this, the image must be scanned many times per second to refresh the light-emitting element. The number of refresh operations per second is called the Refresh rate and is expressed in hertz (Hz).
SDTV	An abbreviation for Standard Definition Television that refers to standard television systems which do not satisfy the conditions for HDTV High-Definition Television.
VGA	A screen size standard with a resolution of 640 (horizontal) × 480 (vertical) dots.
WXGA	A screen size standard with a resolution of 1,280 (horizontal) × 800 (vertical) dots.

Check these sections for important notices about your projector.

► **Related Links**

- "FCC Compliance Statement" [p.87](#)
- "Indication of the manufacturer and the importer in accordance with requirements of EU directive" [p.88](#)
- "Restriction of Use" [p.88](#)
- "Trademarks" [p.88](#)
- "Copyright Notice" [p.88](#)
- "Copyright Attribution" [p.89](#)

FCC Compliance Statement

Supplier's DECLARATION of CONFORMITY

According to 47CFR, Part 2 and 15
 Class B Personal Computers and Peripherals; and/or
 CPU Boards and Power Supplies used with Class B Personal Computers

We: Epson America, Inc.

Located at: 3131 Katella Avenue, Los Alamitos, CA

Tel: 562-981-3840

Declare under sole responsibility that the product identified herein, complies with 47CFR Part 2 and 15 of the FCC rules as a Class B digital device. Each product marketed, is identical to the representative unit tested and found to be compliant with the standards. Records maintained continue to reflect the equipment being produced can be expected to be within the variation accepted, due to quantity production and testing on a statistical basis as required by 47CFR 2.906. Operation is subject to the following two conditions: (1) this device may not cause harmful interference, and (2) this device must accept any interference received, including interference that may cause undesired operation.

Trade Name: EPSON

Type of Product: LCD Projector

Model: HA07C

Options:

Product name	Model
Remote controller	RC4261804

FCC Compliance Statement For United States Users

This device complies with part 15 of the FCC Rules. Operation is subject to the following two conditions: (1) This device may not cause harmful interference, and (2) this device must accept any interference received, including interference that may cause undesired operation.

This equipment has been tested and found to comply with the limits for a Class B digital device, pursuant to Part 15 of the FCC Rules. These limits are designed to provide reasonable protection against harmful interference in a residential installation. This equipment generates, uses, and can radiate radio frequency energy and, if not installed and used in accordance with the instructions, may cause harmful interference to radio communications. However, there is no guarantee that interference will not occur in a particular installation. If this equipment does cause interference to radio and television reception, which can be determined by turning the equipment off and on, the user is encouraged to try to correct the interference by one or more of the following measures.

- Reorient or relocate the receiving antenna.
- Increase the separation between the equipment and receiver.
- Connect the equipment into an outlet on a circuit different from that to which the receiver is connected.
- Consult the dealer or an experienced radio/TV technician for help.

WARNING

The connection of a non-shielded equipment interface cable to this equipment will invalidate the FCC Certification or Declaration of this device and may cause interference levels which exceed the limits established by the FCC for this equipment. It is the responsibility of the user to obtain and use a shielded equipment interface cable with this device. If this equipment has more than one interface connector, do not leave cables connected to unused

interfaces. Changes or modifications not expressly approved by the manufacturer could void the user's authority to operate the equipment.

Indication of the manufacturer and the importer in accordance with requirements of EU directive

Manufacturer: SEIKO EPSON CORPORATION
Address: 3-5, Owa 3-chome, Suwa-shi, Nagano-ken 392-8502 Japan
Telephone: 81-266-52-3131
<http://www.epson.com/>

Importer: EPSON EUROPE B.V.
Address: Atlas Arena, Asia Building, Hoogoorddreef 5,1101 BA Amsterdam
Zuidoost
The Netherlands
Telephone: 31-20-314-5000
<http://www.epson.eu/>

Restriction of Use

When this product is used for applications requiring high reliability/safety such as transportation devices related to aviation, rail, marine, automotive etc.; disaster prevention devices; various safety devices etc; or functional/precision devices etc, you should use this product only after giving consideration to including fail-safes and redundancies into your design to maintain safety and total system reliability. Because this product was not intended for use in applications requiring extremely high reliability/safety such as aerospace equipment, main communication equipment, nuclear power control equipment, or medical equipment related to direct medical care etc, please make your own judgment on this product's suitability after a full evaluation.

Trademarks

EPSON is a registered trademark, EXCEED YOUR VISION and its logos are registered trademarks or trademarks of Seiko Epson Corporation.

Mac, OS X, and macOS are trademarks of Apple Inc.

Microsoft, Windows, and the Windows logo are trademarks or registered trademarks of Microsoft Corporation in the United States and/or other countries.

Google, Google Play, YouTube and Android TV are trademarks of Google LLC.

Manufactured under license from Dolby Laboratories. Dolby, Dolby Audio, and the double-D symbol are trademarks of Dolby Laboratories.

HDMI, the HDMI Logo and High-Definition Multimedia Interface are trademarks or registered trademarks of HDMI Licensing Administrator, Inc.



Wi-Fi™ is a trademark of the Wi-Fi Alliance.

The Bluetooth® word mark and logos are registered trademarks owned by Bluetooth SIG, Inc. and any use of such marks by Seiko Epson Corporation is under license. Other trademarks and trade names are those of their respective owners.

Adobe and Adobe Reader are either registered trademarks or trademarks of Adobe Systems Incorporated in the United States and/or other countries.

Other product names used herein are also for identification purposes only and may be trademarks of their respective owners. Epson disclaims any and all rights in those marks.

Copyright Notice

All rights reserved. No part of this publication may be reproduced, stored in a retrieval system, or transmitted in any form or by any means, electronic, mechanical, photocopying, recording, or otherwise, without the prior written permission of Seiko Epson Corporation. No patent liability is assumed with respect to the use of the information contained herein. Neither is any liability

assumed for damages resulting from the use of the information contained herein.

Neither Seiko Epson Corporation nor its affiliates shall be liable to the purchaser of this product or third parties for damages, losses, costs, or expenses incurred by the purchaser or third parties as a result of: accident, misuse, or abuse of this product or unauthorized modifications, repairs, or alterations to this product, or (excluding the U.S.) failure to strictly comply with Seiko Epson Corporation's operating and maintenance instructions.

Seiko Epson Corporation shall not be liable against any damages or problems arising from the use of any options or any consumable products other than those designated as Original Epson Products or Epson Approved Products by Seiko Epson Corporation.

The contents of this guide may be changed or updated without further notice.

Illustrations in this guide and the actual projector may differ.

Copyright Attribution

This information is subject to change without notice.

© 2020 Seiko Epson Corporation

2020.8 414042900EN