



Laser Short Throw Projector

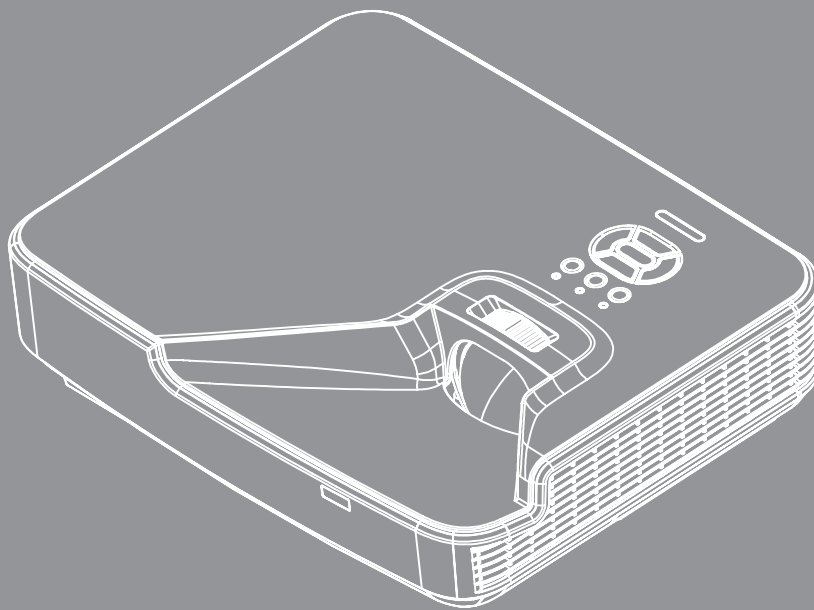



TABLE OF CONTENTS

SAFETY	4
<i>Regulation & Safety Notices.....</i>	6
<i>Safety notice.....</i>	8
<i>Laser safety warnings</i>	8
INTRODUCTION.....	9
<i>Package Overview</i>	9
<i>Product Overview</i>	10
<i>Main Unit</i>	10
<i>Control Panel.....</i>	11
<i>Connections</i>	12
<i>Remote Control</i>	13
SETUP AND INSTALLATION.....	14
<i>Connecting the Projector.....</i>	14
<i>Powering the Projector On/Off</i>	16
<i>Warning Indicator</i>	17
<i>Adjusting the Projected Image</i>	18
USER CONTROLS	22
<i>Control Panel & Remote Control</i>	22
<i>Control Panel.....</i>	22
<i>Remote Control</i>	23
<i>On-screen Display Menus</i>	26
<i>How to operate</i>	26
<i>OSD Menu Structure</i>	27
<i>OSD Menu Photos</i>	29
<i>Picture</i>	36
<i>Screen</i>	38
<i>Settings</i>	40
<i>Volume</i>	42
<i>Options.....</i>	43
<i>Options LASER Settings</i>	45
<i>3D.....</i>	46
<i>LAN</i>	47
APPENDICES	48
<i>Installing and Cleaning the Optional Dust Filter</i>	48
<i>Specification</i>	49
<i>Compatibility Modes</i>	50

<i>VGA Analog</i>	50
<i>HDMI Digital</i>	51
<i>RS232 Commands and Protocol Function List</i>	53
<i>RS232 Port Setting</i>	53
<i>RS232 Signals Connection</i>	53
<i>RS232 Commands Set List</i>	54
<i>Ceiling Mount Installation</i>	56
<i>Optoma global offices</i>	57

SAFETY

	The lightning flash with arrow head within an equilateral triangle is intended to alert the user to the presence of uninsulated “dangerous voltage” within the product’s enclosure that may be of sufficient magnitude to constitute a risk of electric shock to persons.
	The exclamation point within an equilateral triangle is intended to alert the user to the presence of important operating and maintenance (servicing) instructions in the literature accompanying the appliance.

WARNING: TO REDUCE THE RISK OF FIRE OR ELECTRIC SHOCK, DO NOT EXPOSE THIS APPLIANCE TO RAIN OR MOISTURE. DANGEROUS HIGH VOLTAGES ARE PRESENT INSIDE THE ENCLOSURE. DO NOT OPEN THE CABINET. REFER SERVICING TO QUALIFIED PERSONNEL ONLY.

Class B emissions limits

This Class B digital apparatus meets all requirements of the Canadian Interference-Causing Equipment Regulations.

Important Safety Instruction

1. Do not block any ventilation openings. To ensure reliable operation of the projector and to protect from over heating, it is recommended to install the projector in a location that does not block ventilation. As an example, do not place the projector on a crowded coffee table, sofa, bed, etc. Do not put the projector in an enclosure such as a book case or a cabinet that restricts air flow.
2. Do not use the projector near water or moisture. To reduce the risk of fire and/or electric shock, do not expose the projector to rain or moisture.
3. Do not install near heat sources such as radiators, heaters, stoves or any other apparatus such as amplifiers that emits heat.
4. Clean only with dry cloth.
5. Only use attachments/accessories specified by the manufacturer.
6. Do not use the unit if it has been physically damaged or abused.
Physical damage/abuse would be (but not limited to):
 - Unit has been dropped.
 - Power supply cord or plug has been damaged.
 - Liquid has been spilled on to the projector.
 - Projector has been exposed to rain or moisture.
 - Something has fallen in the projector or something is loose inside.Do not attempt to service the unit yourself. Opening or removing covers may expose you to dangerous voltages or other hazards.
7. Do not let objects or liquids enter the projector. They may touch dangerous voltage points and short out parts that could result in fire or electric shock.
8. See projector enclosure for safety related markings.
9. The unit should only be repaired by appropriate service personnel.

Precautions



Please follow all warnings, precautions and maintenance as recommended in this user's guide.

- Warning- Do not look into the projector's lens when the light source is on. The bright light may hurt and damage your eyes.
- Warning- To reduce the risk of fire or electric shock, do not expose this projector to rain or moisture.
- Warning- Please do not open or disassemble the projector as this may cause electric shock.

Do:

- Turn off and unplug the power plug from the AC outlet before cleaning the product.
- Use a soft dry cloth with mild detergent to clean the display housing.
- Disconnect the power plug from AC outlet if the product is not being used for a long period of time.

Do not:

- Block the slots and openings on the unit provided for ventilation.
- Use abrasive cleaners, waxes or solvents to clean the unit.
- Use under the following conditions:
 - In extremely hot, cold or humid environments.
 - ▶ Ensure that the ambient room temperature is within 5 - 40°C.
 - ▶ Relative Humidity is 5 - 40°C, 80% (Max.), non-condensing.
 - In areas susceptible to excessive dust and dirt.
 - Near any appliance generating a strong magnetic field.
 - In direct sunlight.

Copyright

This publication, including all photographs, illustrations and software, is protected under international copyright laws, with all rights reserved. Neither this manual, nor any of the material contained herein, may be reproduced without written consent of the author.

© Copyright 2015

Disclaimer

The information in this document is subject to change without notice. The manufacturer makes no representations or warranties with respect to the contents hereof and specifically disclaims any implied warranties of merchantability or fitness for any particular purpose. The manufacturer reserves the right to revise this publication and to make changes from time to time in the content hereof without obligation of the manufacturer to notify any person of such revision or changes.

Trademark Recognition

Kensington is a U.S. registered trademark of ACCO Brand Corporation with issued registrations and pending applications in other countries throughout the world.

HDMI, the HDMI Logo, and High-Definition Multimedia Interface are trademarks or registered trademarks of HDMI Licensing LLC in the United States and other countries.

IBM is a trademark or registered trademark of International Business Machines, Inc. Microsoft, PowerPoint, and Windows are trademarks or registered trademarks of Microsoft Corporation.

Adobe and Acrobat are trademarks or registered trademarks of Adobe Systems Incorporated.

DLP, DLP Link and the DLP logo are registered trademarks of Texas Instruments and BrilliantColor™ is a trademark of Texas Instruments.

All other product names used in this manual are the properties of their respective owners and are Acknowledged.

Regulation & Safety Notices

This appendix lists the general notices of your projector.

FCC notice

This device has been tested and found to comply with the limits for a Class B digital device pursuant to Part 15 of the FCC rules. These limits are designed to provide reasonable protection against harmful interference in a residential installation. This device generates, uses and can radiate radio frequency energy and, if not installed and used in accordance with the instructions, may cause harmful interference to radio communications.

However, there is no guarantee that interference will not occur in a particular installation. If this device does cause harmful interference to radio or television reception, which can be determined by turning the device off and on, the user is encouraged to try to correct the interference by one or more of the following measures:

- Reorient or relocate the receiving antenna.
- Increase the separation between the device and receiver.
- Connect the device into an outlet on a circuit different from that to which the receiver is connected.
- Consult the dealer or an experienced radio/television technician for help.

Notice: Shielded cables

All connections to other computing devices must be made using shielded cables to maintain compliance with FCC regulations.

Caution

Changes or modifications not expressly approved by the manufacturer could void the user's authority, which is granted by the Federal Communications Commission, to operate this projector.

Operation conditions

This device complies with Part 15 of the FCC Rules. Operation is subject to the following two conditions:

1. This device may not cause harmful interference and
2. This device must accept any interference received, including interference that may cause undesired operation.

Notice: Canadian users

This Class B digital apparatus complies with Canadian CES-003.

Remarque à l'intention des utilisateurs canadiens

Cet appareil numérique de la classe B est conforme à la norme NMB-003 du Canada.

Declaration of Conformity for EU countries

- EMC Directive 2004/108/EC (including amendments)
- Low Voltage Directive 2006/95/EC
- R & TTE Directive 1999/5/EC (if product has RF function)

Disposal instructions



Do not throw this electronic device into the trash when discarding. To minimize pollution and ensure utmost protection of the global environment, please recycle it.

Safety notice

Laser safety warnings

This product is classified as CLASS 1 LASER PRODUCT - RISK GROUP 1 according to IEC 60825-1 : 2014 complies with FDA regulations 21 CFR 1040.10 and 1040.11 as a Risk Group 1 , LIP (Laser Illuminated Projector) as defined in IEC 62471:2006 except for deviations pursuant to Laser Notice No. 50, dated June 24, 2007.



Complies with 21 CFR 1040.10 and 1040.11 as a Risk Group 1 LIP as defined in IEC 62471:2006 except for deviations pursuant to Laser Notice No. 50, dated June 24, 2007."

DLP Projector/投影机/投影机/프로젝터

Regulatory No./aucune réglementation: DAZXSGZST

Input /entrée/輸入/电压/电流/정격: AC 100-240V~, 50/60Hz, 3.5A

CAN ICES-3(B)/NMB-3(B)



For EU importer only:
Optoma Europe Ltd.
Unit 1 Network 41 Bourne End Mills, Hemel
Hempstead, Herts UK

This device complies with part 15 of the FCC Rules. Operation is subject to the following two conditions:

- (1) This device may not cause harmful interference, and
- (2) This device must accept any interference received, including interference that may cause undesired operation.

Made In China/製造地:中國/제조국:중국

Warning! Failure to comply with the following could result in death or serious injury.

- This projector has a built-in Class 4 laser module. Never attempt to disassemble or modify the projector.
- Any operation or adjustment not specifically instructed in the User manual creates the risk of hazardous laser radiation exposure.
- Do not open or disassemble the projector as this may cause damage or exposure to laser radiation.
- Do not stare into beam when the projector is on. The bright light may result in permanent eye damage.
- When turning on the projector, make sure no one within projection range is looking into the lens.
- Follow the control, adjustment, or operation procedures to avoid damage or injury from exposure of laser radiation.
- The instructions for the assembly, operation, and maintenance include clear warnings concerning precautions to avoid possible exposure to hazardous laser radiation.

INTRODUCTION

Package Overview

Unpack and inspect the box contents to ensure all parts listed below are in the box. If something is missing, please contact your nearest customer service center.

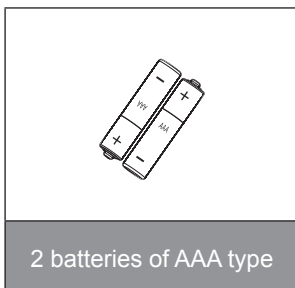
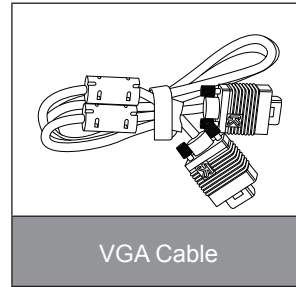
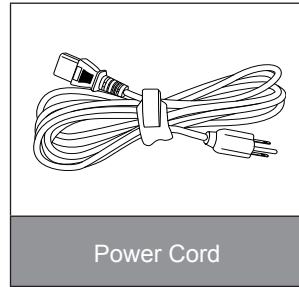
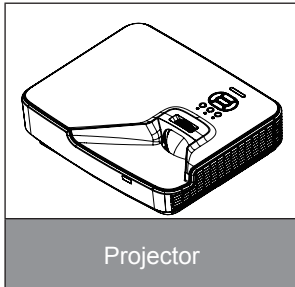

Note: Due to different applications in each country, some regions may have edifferent accessories.

INTRODUCTION

Product Overview

Main Unit

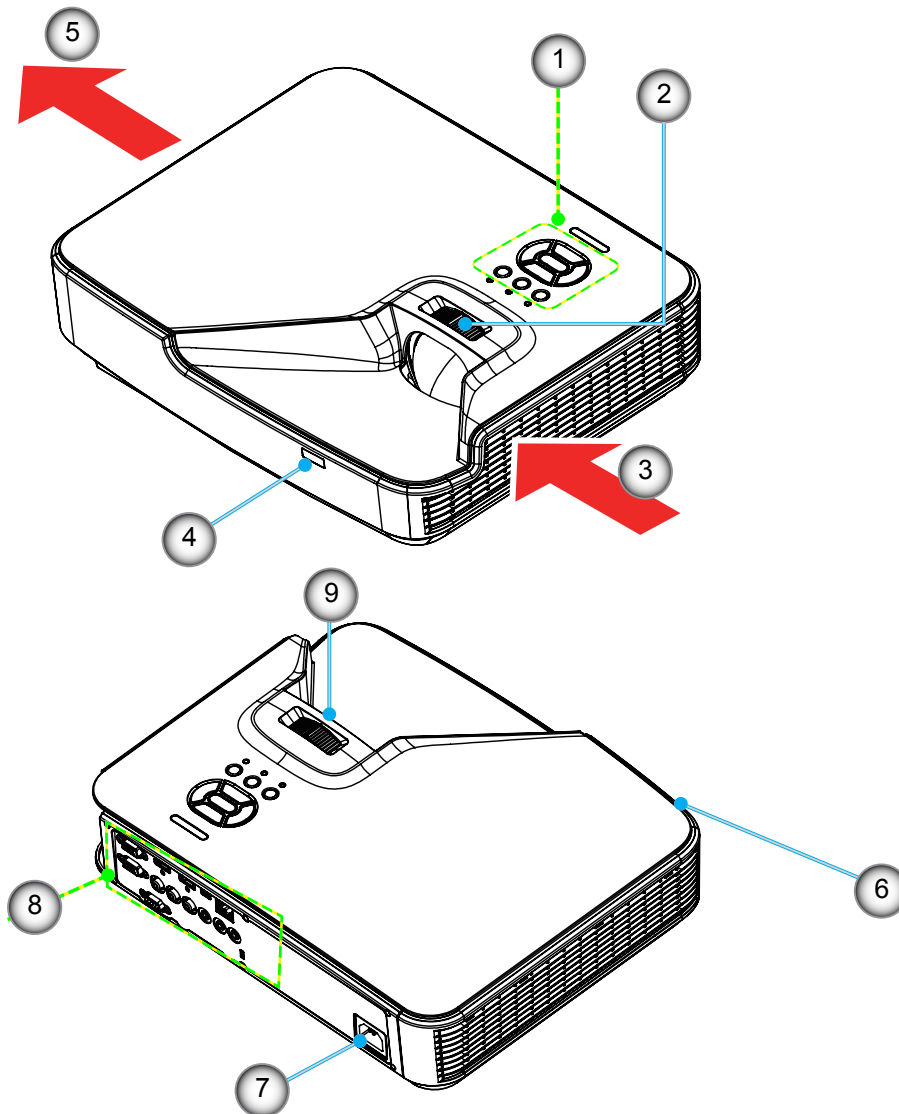

Note: The interface is subject to model's specifications.

No	Item
1.	Control Panel
2.	Focusing Ring
3.	Ventilation (inlet)
4.	IR Receiver
5.	Ventilation (outlet)

No	Item
6.	Speaker
7.	Power Socket
8.	Input / Output Connections
9.	Lens

INTRODUCTION

Control Panel

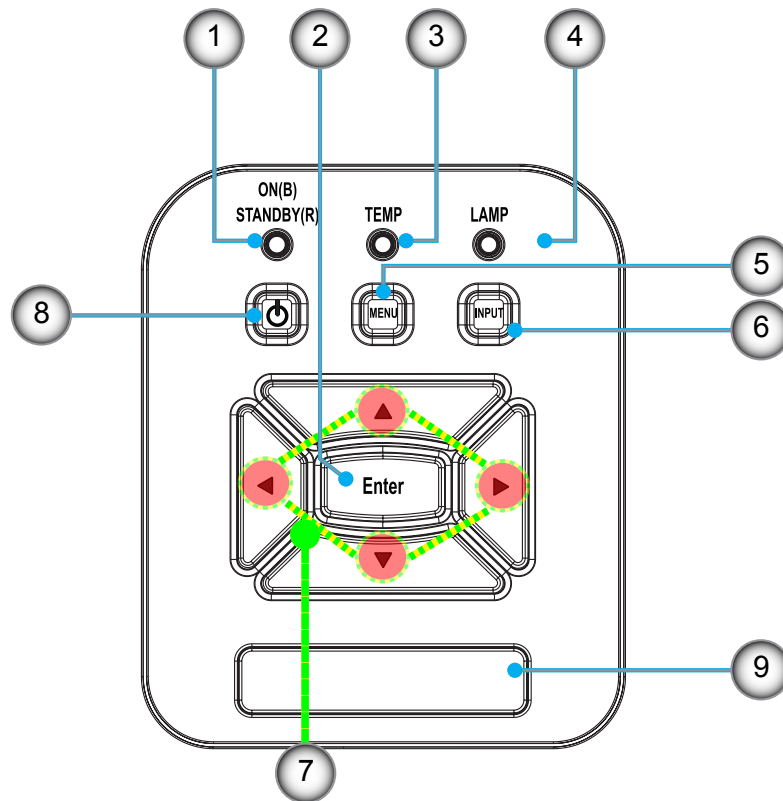

No	Item
1.	Power LED
2.	Enter
3.	Temp LED
4.	Lamp LED
5.	Menu

No	Item
6.	Signal source
7.	Four Directional Select Keys
8.	Power/Standby button
9.	IR Receiver

INTRODUCTION

Connections

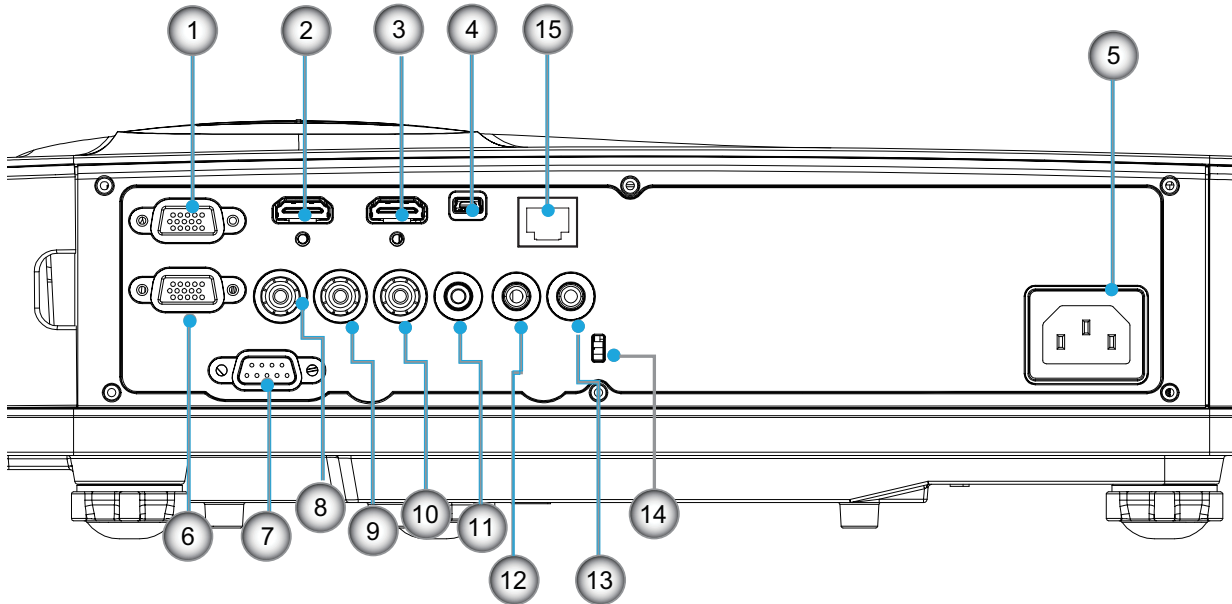

Note: The interface is subject to model's specifications.
Monitor loop through only support in VGAIn/ YPbPr.

No	Item
1.	VGA-In/YPbPr Connector(PC Analog Signal/Component Video Input/HDTV/YPbPr)
2.	HDMI2 Input Connector
3.	HDMI1 Input Connector
4.	USB Connector
5.	Power Socket
6.	VGA-Out Connector
7.	RS-232 Connector (9-pin DIN Type)
8.	Composite Video Input Connector
9.	Composite Audio Input (right) Connector
10.	Composite Audio Input (left) Connector
11.	Audio Output Connector (3.5mm mini jack)
12.	Audio Input Connector (3.5mm mini jack)
13.	Audio Input Connector (microphone)
14.	KensingtonTM Lock Port
15.	RJ45 (10Mbps/100Mbps)

INTRODUCTION

Remote Control

No	Item
1.	Infrared transmitter
2.	LED Indicator
3.	Power On/Off
4.	Enter
5.	Four Directional Select Keys
6.	Menu
7.	Exit
8.	Zoom +
9.	Reset
10.	Auto
11.	Input
12.	Zoom -
13.	Volume +/-
14.	Keystone +/-
15.	Image
16.	Black screen
17.	Aspect
18.	VGA1
19.	HDMI1
20.	VGA2
21.	HDMI2
22.	Video
23.	Freeze
24.	Numbered keypad (for password input)

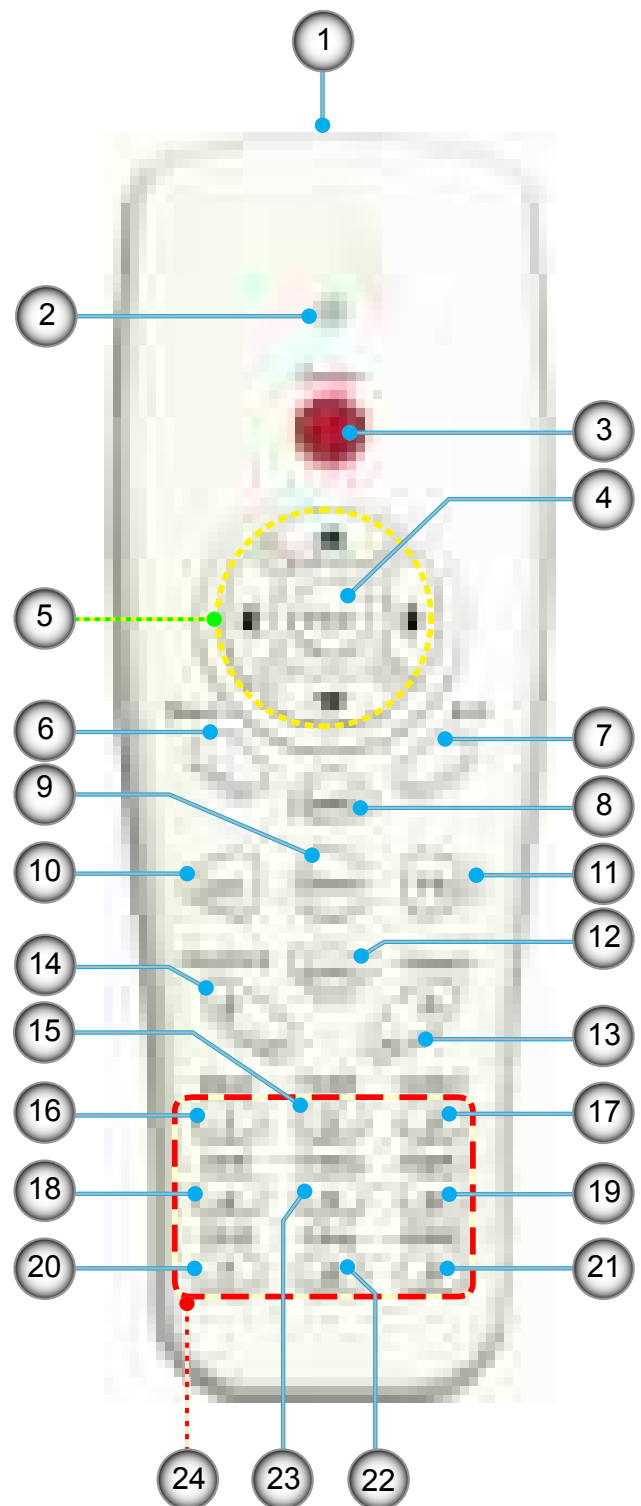

SETUP AND INSTALLATION

Connecting the Projector

Connect to Computer/Notebook

Note:

Due to the difference in applications for each country, some regions may have different accessories.

() Optional accessory*

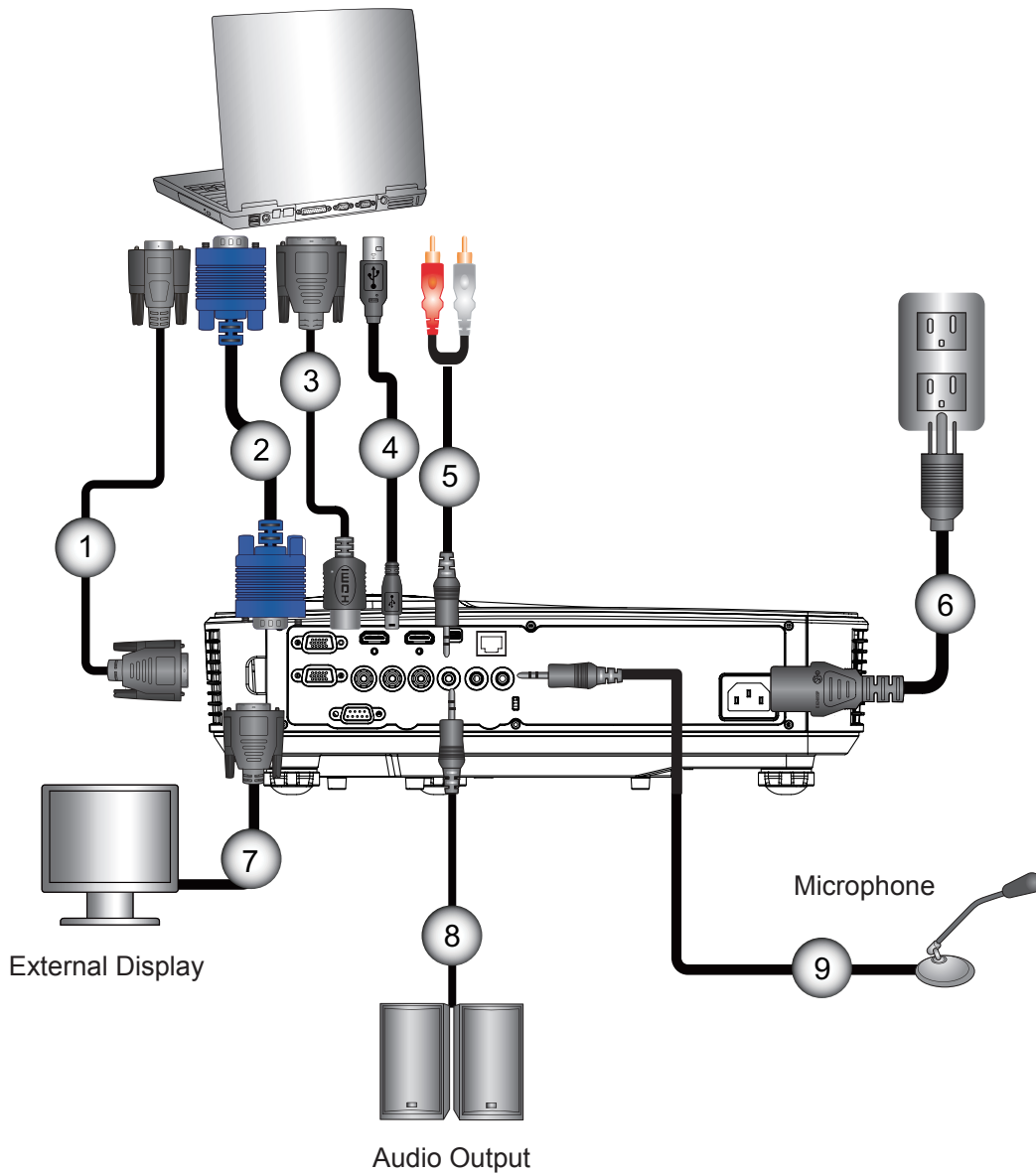

No	Item
1.	RS232 Cable*
2.	VGA Cable
3.	HDMI Cable*
4.	USB Cable*
5.	Audio Cable/RCA*

No	Item
6.	Power Cord
7.	VGA Output Cable*
8.	Audio Output Cable*
9.	Audio Input Cable*

SETUP AND INSTALLATION

Connect to Video Sources

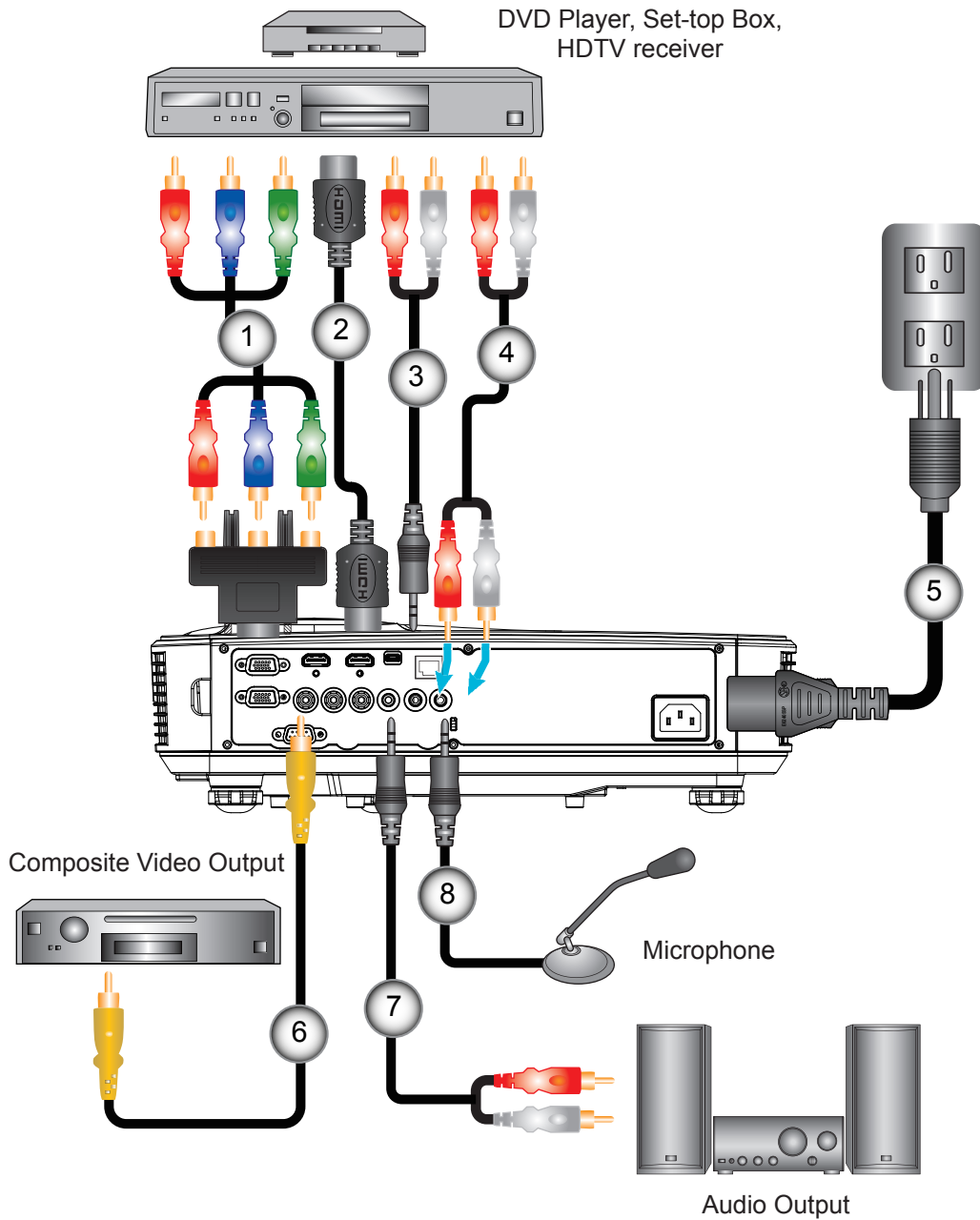

No	Item
1.	15-Pin to 3 RCA Component/HDTV Adaptor*
2.	HDMI Cable*
3.	Audio Cable*
4.	Audio Cable/RCA*

No	Item
5.	Power Cord
6.	Composite Video Cable*
7.	Audio Cable/RCA*
8.	Audio Input Cable*

Note:

Due to the difference in applications for each country, some regions may have different accessories.
 (*) Optional accessory

SETUP AND INSTALLATION

Powering the Projector On/Off

Powering On the Projector

1. Securely connect the power cord and signal cable. When connected, the POWER/STANDBY LED will turn Orange.
2. Turn on the lamp by pressing “” button either on the projector or on the remote. At this moment, the POWER/STANDBY LED will now turn Blue. ①

The startup screen will display in approximately 10 seconds. The first time you use the projector, you will be asked to select the preferred language and power saving mode.

3. Turn on and connect the source that you want to display on the screen (computer, notebook, video player, etc). The projector will detect the source automatically. If not, push menu button and go to “OPTIONS”. Make sure that the “Source Lock” has been set to “Off”.

- ▶ If you connect multiple sources at the same time, press the “INPUT” button on the control panel or direct source keys on the remote control to switch between inputs.

Note: When the power mode is in standby mode (power consumption 0.5W), the VGA output/input and audio will be deactivated when the projector is in standby.

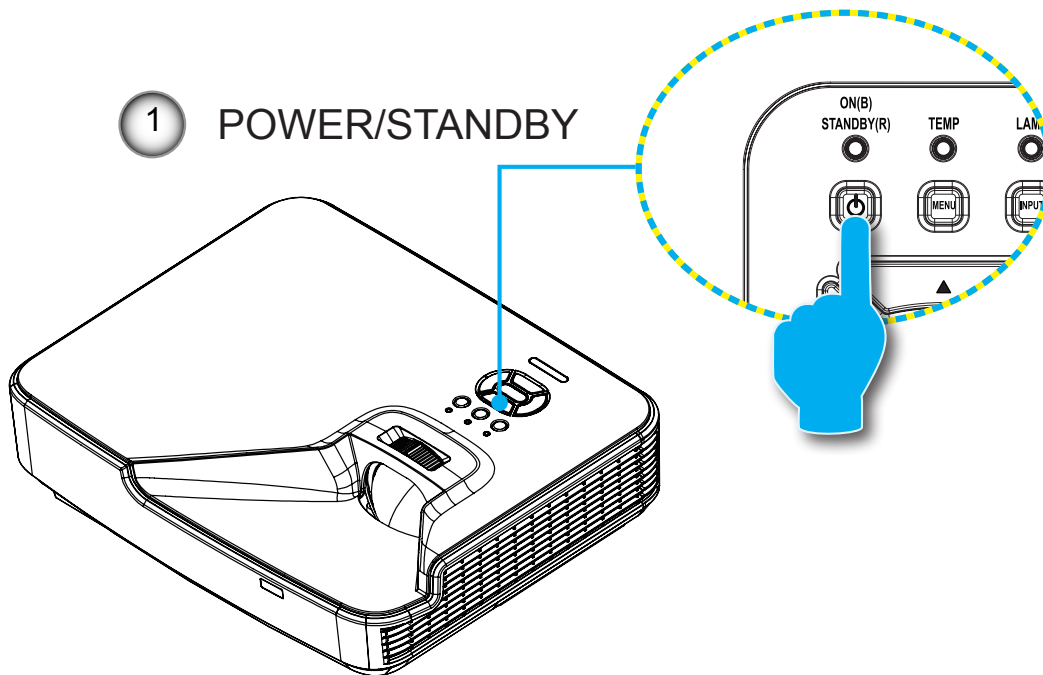

Note: Turn on the projector first and then select the signal sources.

SETUP AND INSTALLATION

Powering Off the Projector

1. Press the “⏻” button on the remote control or on the control panel to turn off the projector.
The following message will be displayed on the screen.



- Press the “⏻” button again to confirm otherwise the message will disappear after 10 seconds. When you press the “⏻” button for the second time, the fan will start cooling the system and will shut down.
2. The cooling fans continue to operate for about 4 seconds for cooling cycle and the POWER/STANDBY LED will flash Orange. When the POWER/STANDBY LED lights solid Orange, the projector has entered standby mode.
If you wish to turn the projector back on, you must wait until the projector has completed the cooling cycle and has entered standby mode. Once in standby mode, simply press “⏻” button to restart the projector.
 3. Disconnect the power cord from the electrical outlet and the projector.

Warning Indicator

When the warning indicators (see below) come on, the projector will automatically shutdown:

- ❖ “LAMP” LED indicator is lit red and if “POWER/STANDBY” indicator flashes amber.
- ❖ “TEMP” LED indicator is lit red, this indicates the projector has overheated. Under normal conditions, the projector can be switched back on.
- ❖ “TEMP” LED indicator flashes red and if “POWER/STANDBY” indicator flashes amber.

Unplug the power cord from the projector, wait for 30 seconds and try again. If the warning indicator light up again, please contact your nearest service center for assistance.

Note: Contact the nearest service center if the projector displays these symptoms.

SETUP AND INSTALLATION

Adjusting the Projected Image

Adjusting the Projector's Height

The projector is equipped with elevator feet for adjusting the image height.

1. Locate the adjustable foot you wish to modify on the underside of the projector.
2. Rotate the adjustable ring clockwise to raise the projector or counter clockwise to lower it. Repeat with the remaining feet as needed.

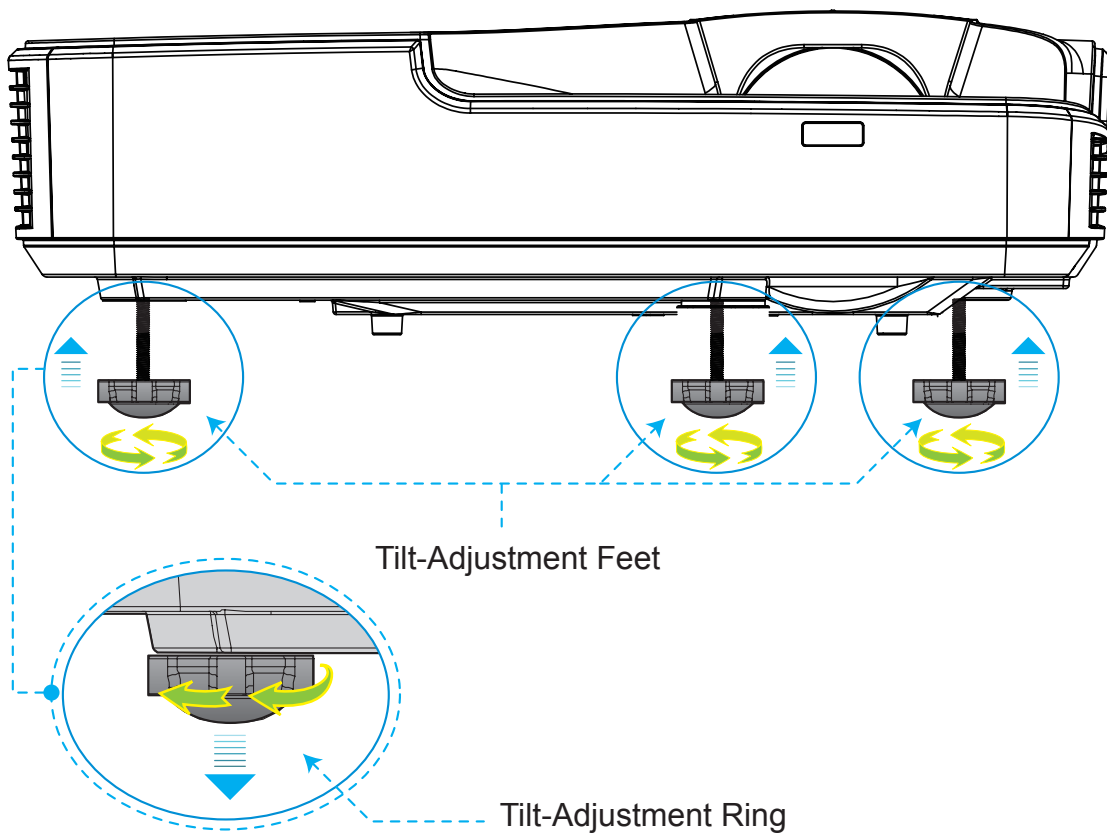

SETUP AND INSTALLATION

Adjusting zoom-in of the projector

To focus on the image, slide the focus ring to the left or to the right until the image is clear.

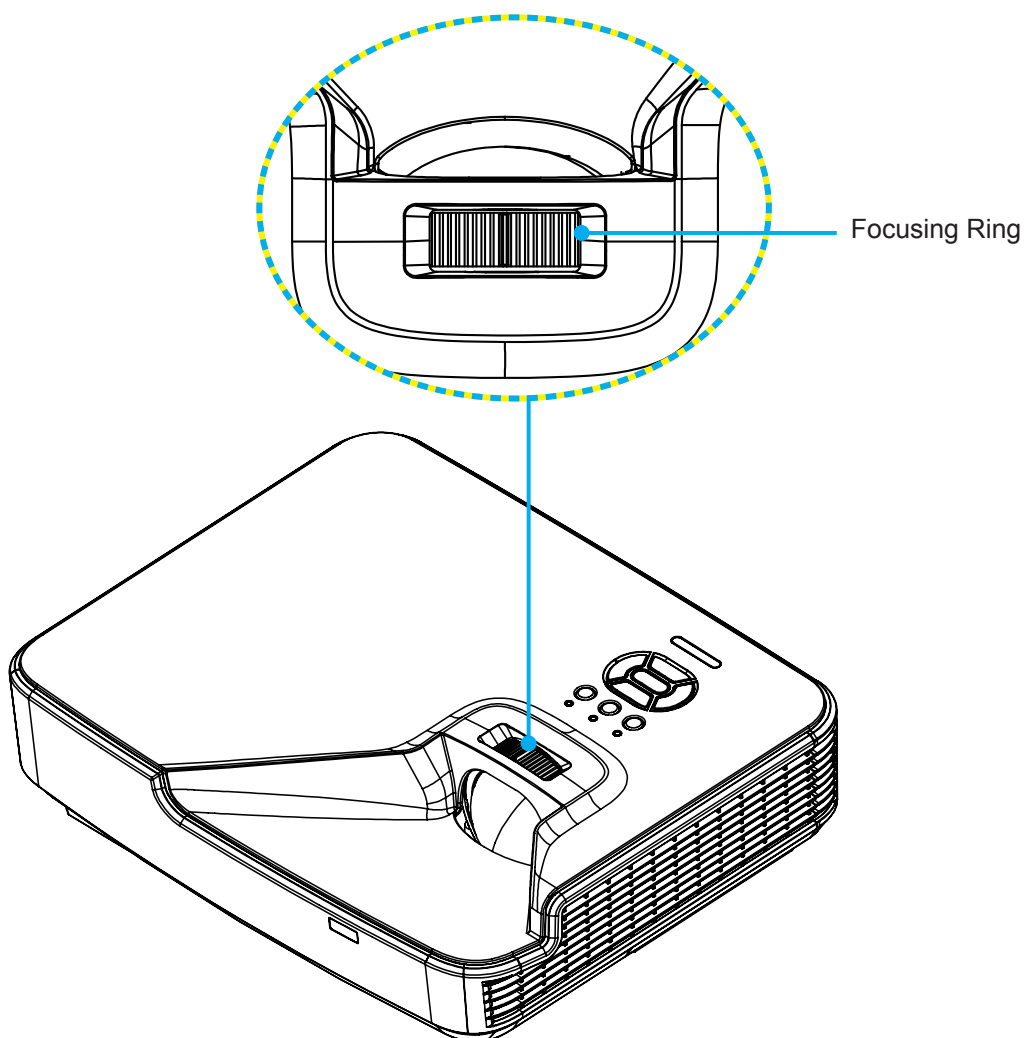

SETUP AND INSTALLATION

Adjusting Projection Image Size (Diagonal)

XGA/WXGA series: focus range 1.3123 ~ 10.1706 ft. (0.4 ~3.1m)

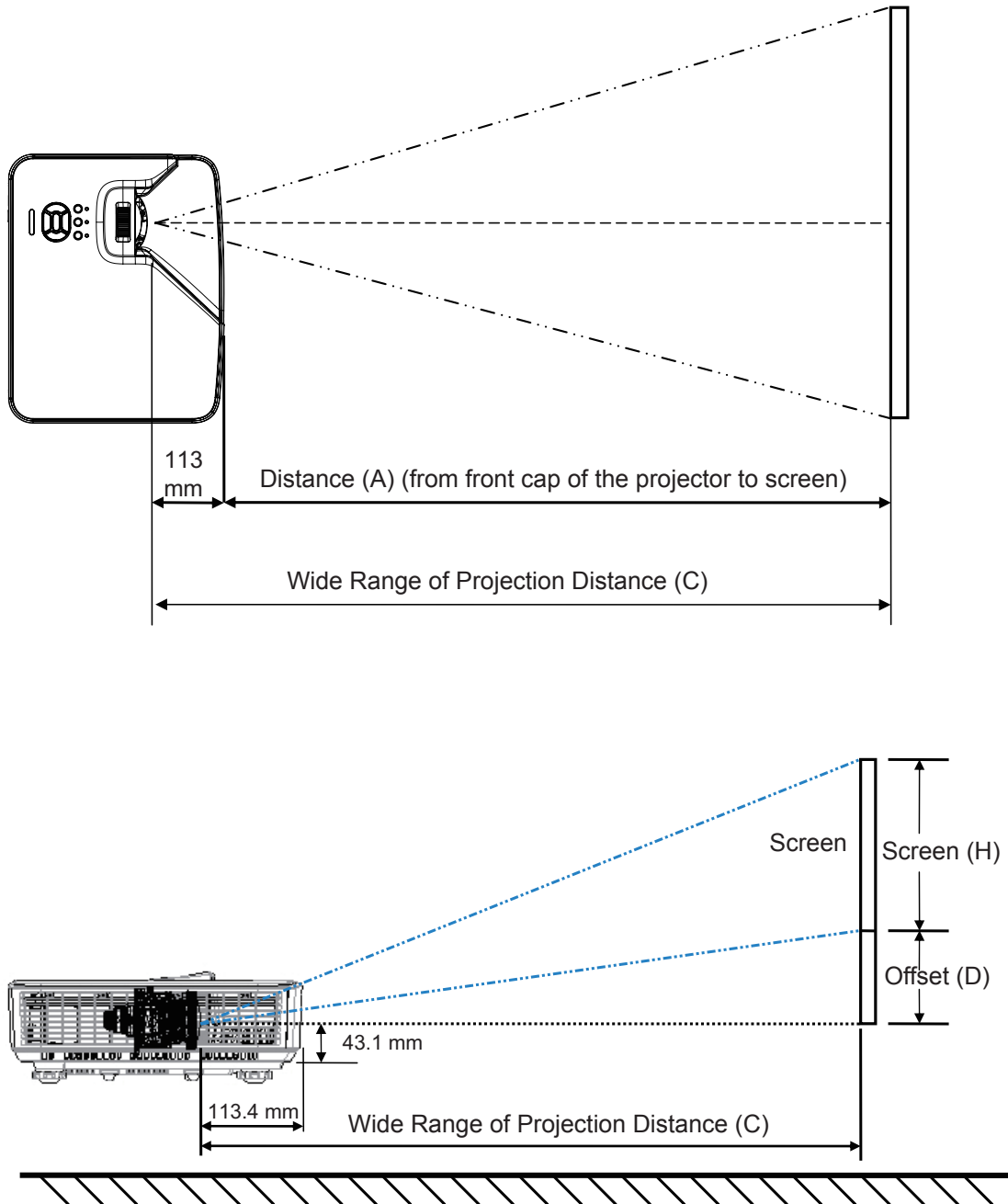

SETUP AND INSTALLATION

XGA

Screen Size W x H						C (Projection Distance)		Front cover to screen (mm)	D (Offset)		Bottom cover to bottom of screen (mm)
Diagonal Length of Image		Width		Height							
inch	mm	inch	mm	inch	mm	inch	mm		inch	mm	
32	812.8	25.6	650.2	19.2	487.6	15.8	401.2	287.8	3.4	86.4	129.5
36	914.4	28.8	731.5	21.6	548.6	17.8	451.3	337.9	3.8	97.2	140.3
60	1524	48	1219.2	36	914.4	29.6	752.2	638.8	6.4	161.9	205.0
75	1905	60	1524	45	1143	37.0	940.3	826.9	8.0	202.4	245.5
77	1955.8	61.6	1564.6	46.2	1173.4	38.0	965.4	852.0	8.2	207.8	250.9
80	2032	64	1625.6	48	1219.2	39.5	1003.0	889.6	8.5	215.9	259.0
100	2540	80	2032	60	1524	49.4	1253.7	1140.3	10.6	269.9	313.0
120	3048	96	2438.4	72	1828.8	59.2	1504.5	1391.1	12.8	323.8	366.9
150	3810	120	3048	90	2286	74.0	1880.6	1767.2	15.9	404.8	447.9
180	4572	144	3657.6	108	2743.2	88.8	2256.7	2143.3	19.1	485.8	528.9
200	5080	160	4064	120	3048	98.7	2507.5	2394.1	21.3	539.7	582.8
210	5334	168	4267.2	126	3200.4	103.7	2632.9	2519.5	22.3	566.7	609.8
247	6273.8	197.6	5019.0	148.2	3764.2	121.9	3096.7	2983.3	26.2	666.6	709.7

WXGA

Screen Size W x H						C (Projection Distance)		Front cover to screen (mm)	D (Offset)		Bottom cover to bottom of screen (mm)
Diagonal Length of Image		Width		Height							
inch	mm	inch	mm	inch	mm	inch	mm		inch	mm	
36	914.4	30.5	775.4	19.1	484.6	15.9	404.0	290.6	2.9	72.7	115.8
60	1524	50.9	1292.3	31.8	807.7	26.5	673.3	559.9	4.8	121.2	164.3
75	1905	63.6	1615.4	39.7	1009.6	33.1	841.6	734.9	6.0	151.4	194.5
87	2209.8	73.8	1873.9	46.1	1171.2	38.4	976.3	862.9	6.9	175.7	218.8
92	2336.8	78.0	1981.6	48.8	1238.5	40.6	1032.4	919.0	7.3	185.8	228.9
100	2540	84.8	2153.9	53.0	1346.2	44.2	1122.2	1008.8	7.9	201.9	245.0
120	3048	101.8	2584.7	63.6	1615.4	53.0	1346.6	1233.2	9.5	242.3	285.4
150	3810	127.2	3230.9	79.5	2019.3	66.3	1683.3	1569.9	11.9	302.9	346.0
180	4572	152.6	3877.0	95.4	2423.2	79.5	2019.9	1906.5	14.3	363.5	406.6
200	5080	169.6	4307.8	106.0	2692.4	88.4	2244.4	2131.0	15.9	403.9	447.0
210	5334	178.1	4523.2	111.3	2827.0	92.8	2356.6	2243.2	16.7	424.1	467.2
246	6248.4	208.6	5298.6	130.4	3311.6	108.7	2760.6	2647.2	19.6	496.7	539.8
276	7010.4	234.0	5944.8	146.3	3715.5	121.9	3097.2	2983.8	21.9	557.3	600.4



❖ This table is for user's reference only.

USER CONTROLS

Control Panel & Remote Control

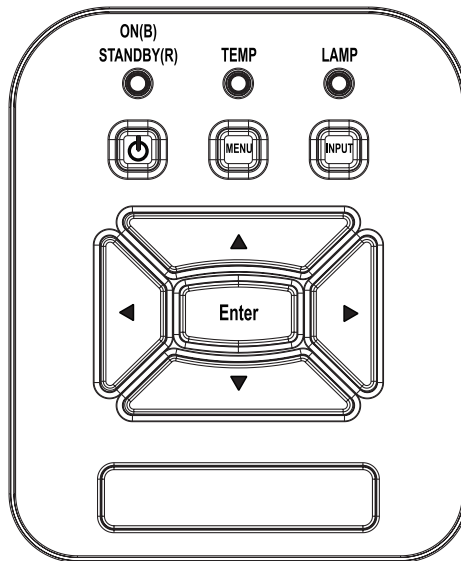
Control Panel



Name	Description
POWER 	Refer to the “Power On/Off the Projector” section on pages 13-14.
Enter	Press “Enter” to confirm your item selection.
INPUT	Press “INPUT” to select an input signal.
MENU	Press “MENU” to launch the on-screen display (OSD) menu. To exit OSD, press “MENU” again.
Four Directional Select Keys	Use ▲▼◀▶ to select items or make adjustments to your selection.
LAMP LED	Refer to the LED indicator of the projector light source status.
TEMP LED 	Refer to the LED indicator of the projector temperature status.
ON/STANDBY LED 	Refer to the LED indicator of the projector power status.

USER CONTROLS

Remote Control



Name	Description
Infrared transmitter	Sends signals to the projector.
LED	LED Indicator.
Power 	Refer to the “Power On/Off the Projector” section on pages 13-14.
Exit	Press “Exit” to close the OSD menu.
Zoom +	Zoom in the projector display.
Reset	Return the adjustments and settings to the factory default values. (except for lamp counter)
Zoom -	Zoom out the projector display.
Enter	Confirm your item selection.
Source	Press Source to select an input signal.
Auto	Automatically synchronizes the projector to the input source.
Four Directional Select Keys	Use ▲▼◀▶ to select items or make adjustments to your selection.
Keystone +/-	Adjust image distortion caused by tilting the projector.
Volume +/-	Adjust to increase / decrease the volume.
Aspect	Use this function to choose your desired aspect ratio.
Menu	Press “Menu” to launch the on-screen display (OSD) menu. To exit OSD, press “Menu” again.
VGA1	Press “VGA1” to choose VGA IN 1 connector.
Black screen	Momentarily turns off/on the audio and video.
HDMI1	Press “HDMI1” to choose HDMI IN 1connector.
HDMI2	Press “HDMI2” to choose HDMI IN 2connector.
VGA2	Press “VGA2” to choose VGA IN 2 connector.
Video	Press “Video” to choose Composite video source.
Freeze	Pause the screen image. Press again to resume the screen image.
Image	Select the display mode from Bright, PC, Movie, Game, and User.

USER CONTROLS

Remote IR Code

Key Code Table								
Key Position		Key Legend	Key Matrix	Repeat format	CODE			
					Custom code		Data	
					Byte1	Byte2	Byte3	Byte4
K13	1	Power	13	F1	FF	FF	E8	17
K10	2		16	-	-	-	-	
K15	3	▲	1B	F2	FF	FF	E7	18
K29	4	◀	03	F2	FF	FF	E6	19
K30	5	Enter	23	F1	FF	FF	F8	07
K3	6	▶	19	F2	FF	FF	F7	08
K18	7	▼	1A	F2	FF	FF	F6	09
K14	8	Menu	0B	F1	FF	FF	EB	14
K32	9	Zoom+	22	F2	FF	FF	FB	04
K12	10	Exit	1E	F1	FF	FF	FF	00
K16	11	Auto	12	F2	FF	FF	FA	05
K31	12	Reset	02	F1	FF	FF	EA	15
K27	13	Input	06	F2	FF	FF	E0	1F
K17	14	Zoom-	0A	F2	FF	FF	FE	01
K2	15	Keystone+	09	F2	FF	FF	F0	0F
K6	16	Keystone-	18	F2	FF	FF	E2	1D
K8	17	Volume-	0F	F2	FF	FF	F2	0D
K25	18	Volume+	07	F2	FF	FF	BD	42
K21	19	Blank / 1	01	F1	FF	FF	BE	41
K23	20	Image / 2	00	F1	FF	FF	F3	0C
K9	21	Aspect / 3	1F	F1	FF	FF	E3	1C
K22	22	VGA1 / 4	21	F1	FF	FF	BF	40
K24	23	Freeze / 5	20	F1	FF	FF	EC	13
K26	24	HDMI1/ 6	27	F1	FF	FF	E5	1A
K1	25	VGA2 / 7	11	F1	FF	FF	E4	1B
K4	26	Video / 8	10	F1	FF	FF	EF	10
K7	27	HDMI2 / 9	17	F1	FF	FF	E1	1E

USER CONTROLS

Min/max gap

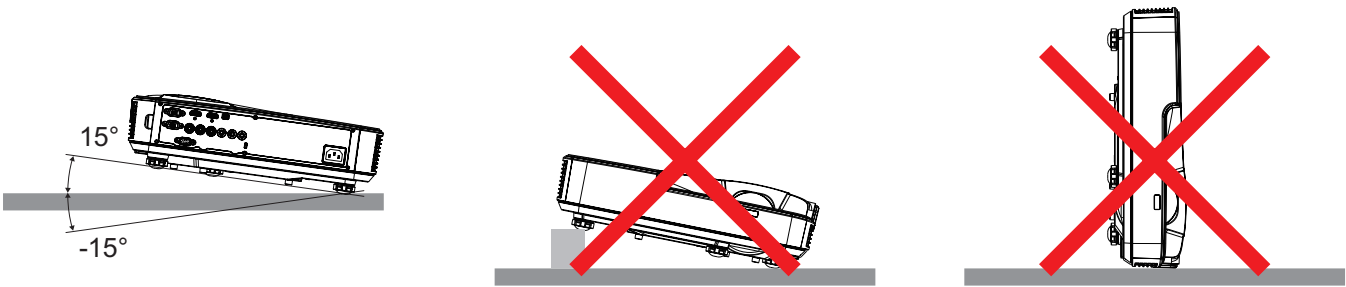

- Allow at least 30 cm clearance around the exhaust vent.

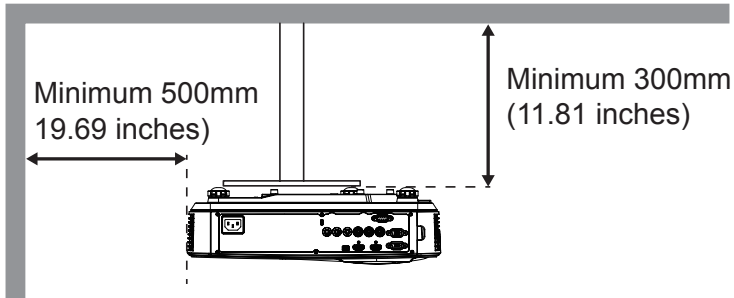
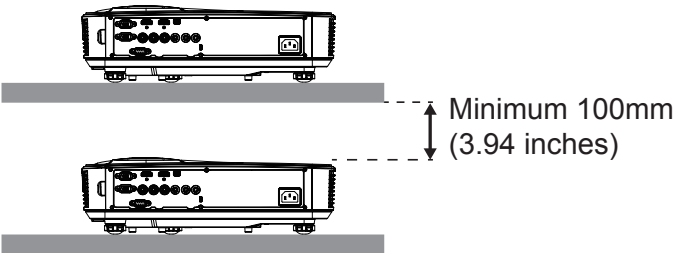
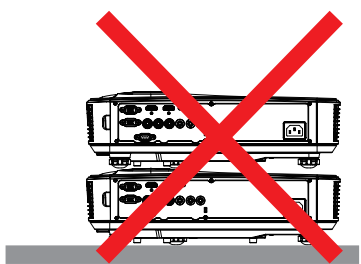
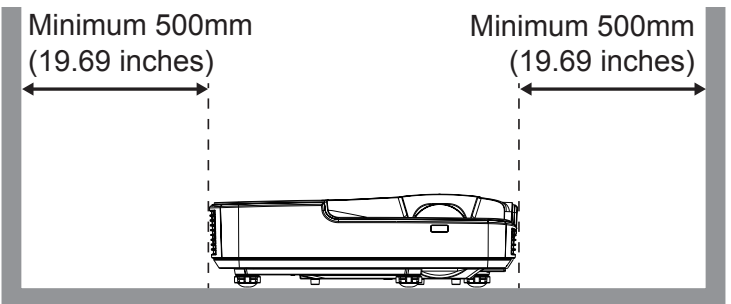
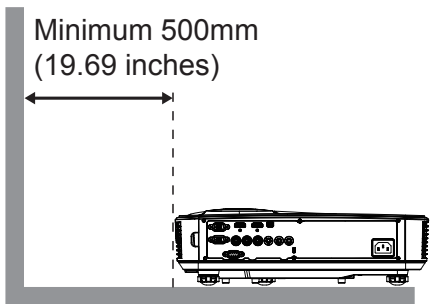

USER CONTROLS

On-screen Display Menus

The Projector has multilingual On-screen Display menus that allow you to make image adjustments and change a variety of settings.

How to operate

1. To open the OSD menu, press “Menu” on the Remote Control or Projector Keypad.
2. When OSD is displayed, use ▲▼ keys to select any item in the main menu. While making a selection on a particular page, press the ► or “Enter” key to enter sub menu.
3. Use the ▲▼ keys to select the desired item and adjust the settings using the ◀▶ key.
4. Select the next item to be adjusted in the sub menu and adjust as described above.
5. Press “Enter” to confirm.
6. To exit, press “Menu” again. The OSD menu will close and the projector will automatically save the new settings.

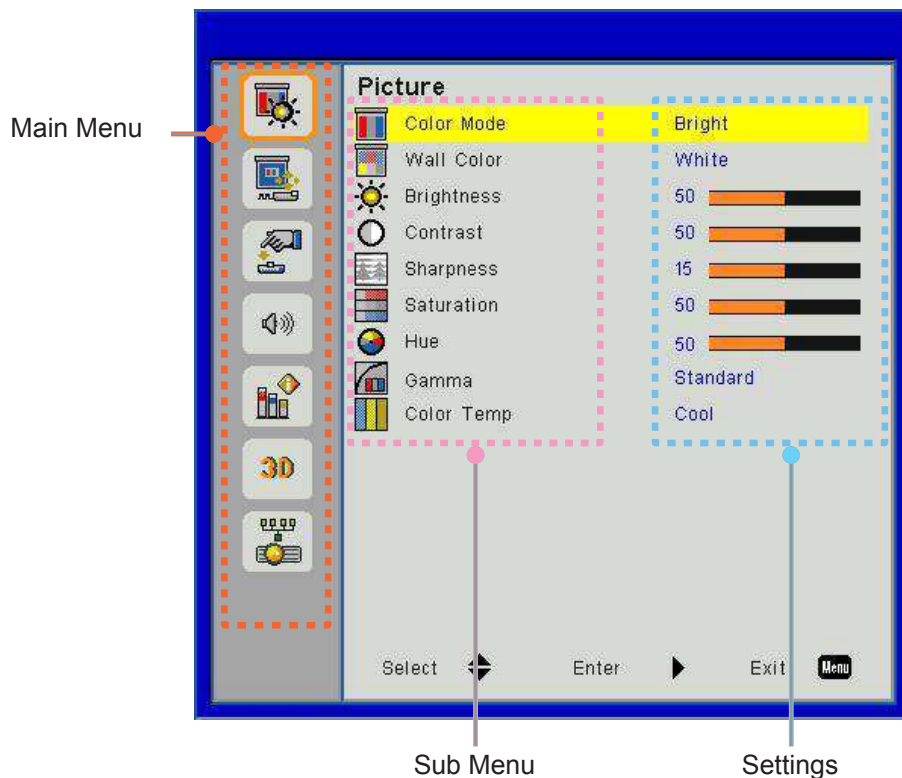

USER CONTROLS

OSD Menu Structure

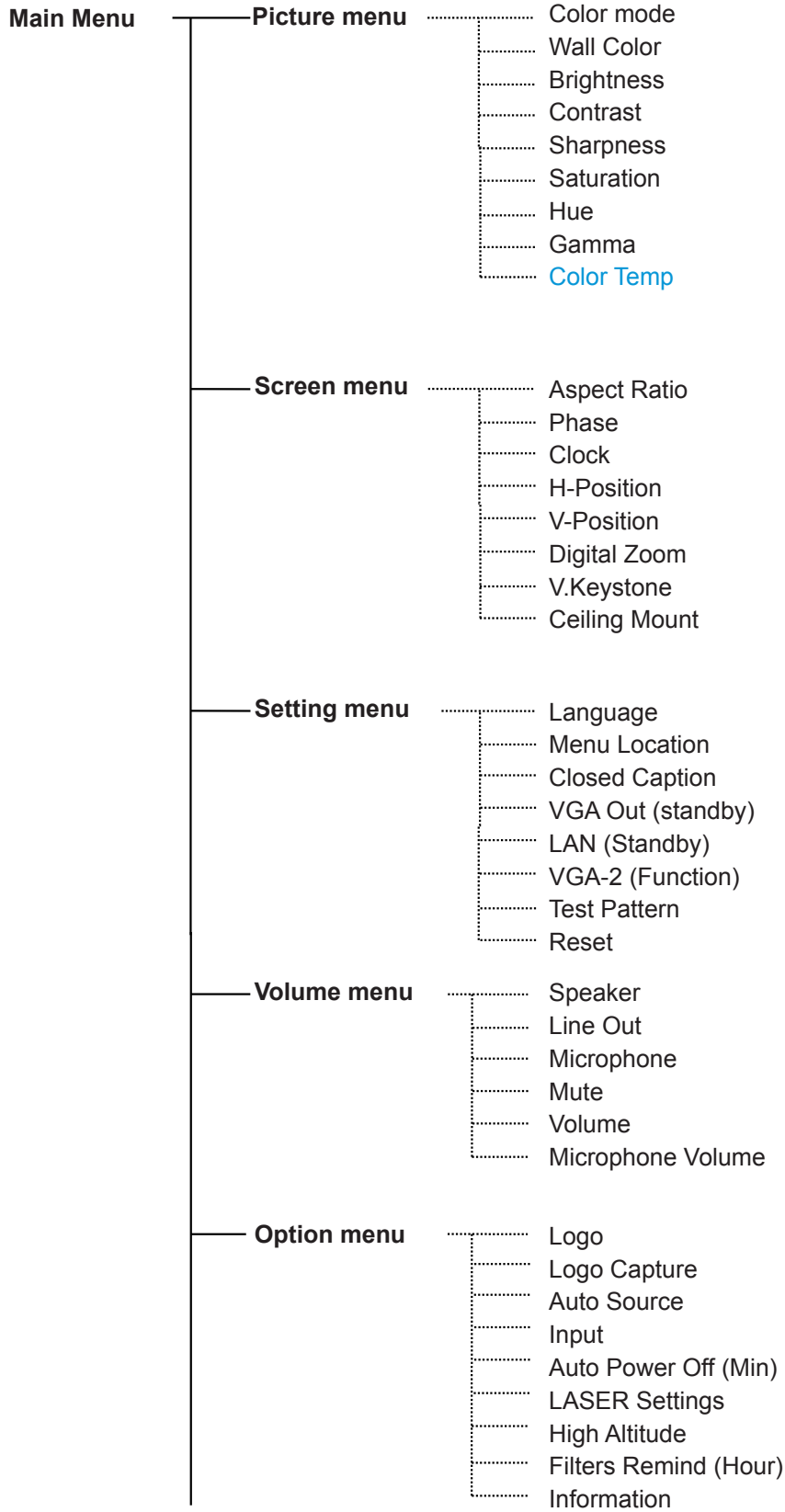

USER CONTROLS

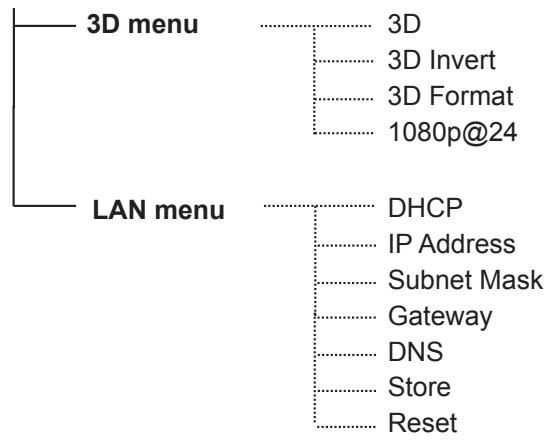

USER CONTROLS

OSD Menu Photos

Picture Menu

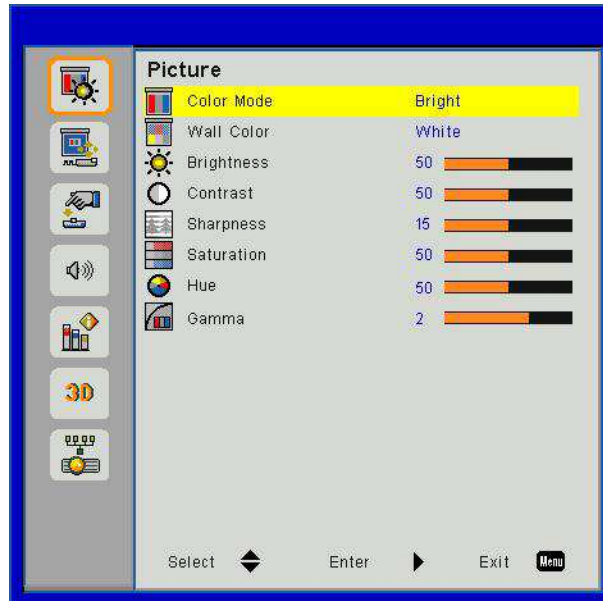

Item	Value/Range	Default	Remark
Color Mode	Bright / PC / Movie/ Game/User	PC	
Wall Color	White/Light Yellow/Light Blue/ Pink/Dark Green	White	
Brightness	0~100	49	
Contrast	0~100	52	PC mode : 55
Sharpness	0~31	15	Video source Only
Saturation	0~100	50	Video source Only
Hue	0~100	50	Video source Only
Degamma	0~3	3	

USER CONTROLS

Screen Menu

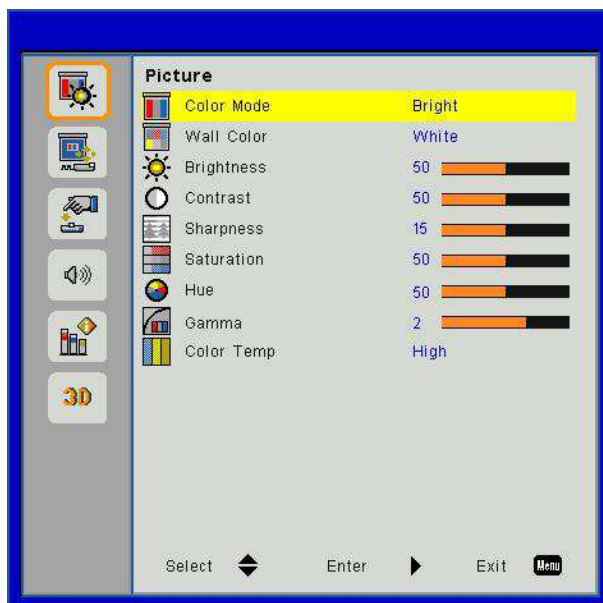

Item	Value/Range	Default	Remark
Aspect Ratio	Auto/4:3/16:9/16:10/Fill Screen	Fill Screen	
Phase	0~31		
Clock	-5~5		
H-Position	-5~5	0	
V-Position	-5~5	0	
Digital Zoom	0~10	0	
V.Keystone	-40~40	0	
Ceiling Mount	Front/Front Ceiling/Rear/Rear Ceiling	Front Ceiling	

USER CONTROLS

Setting Menu

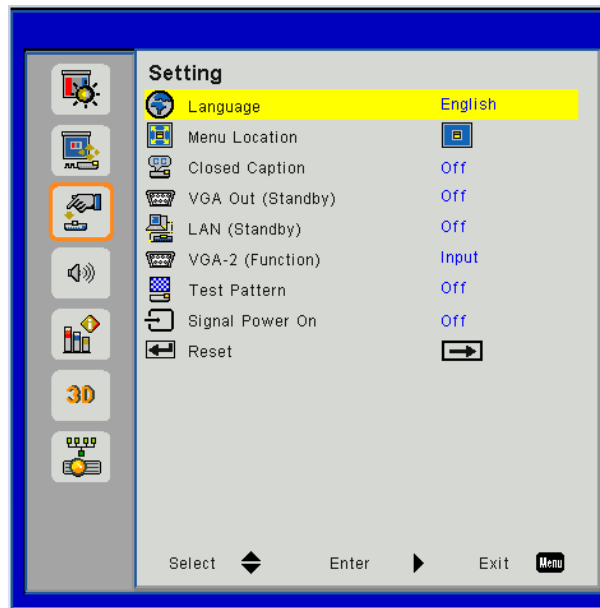

Item	Value/Range	Default	Remark
Language	English/Deutsch/Svenska/Français/العربية/Nederlands/Norsk/Dansk/简体中文/PolSKI/한국어/Русский/Español/繁體中文/Italiano/Português/Türkçe/日本語/	简体中文	
Menu Location	Center/Top Left/Top Right /Bottom Left/Bottom Right	Center	
Closed Caption	Off/CC1/ CC2/ CC3/ CC4	Off	
VGA Out (Standby)	On/Off	Off	
LAN (Standby)	On/Off	Off	
VGA-2 (Function)	Input / Output	Input	
Test Pattern	On/Off	Off	
Signal Power On	On/Off	Off	
Reset			

USER CONTROLS

Volume Menu

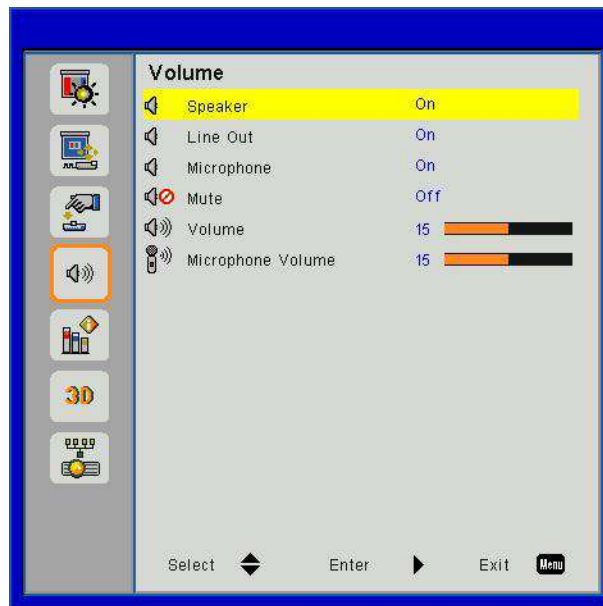

Item	Value/Range	Default	Remark
Speaker	On/Off	On	
Line Out	On/Off	On	
Microphone	On/Off	On	
Mute	On/Off	Off	
Volume	0 ~ 30	15	
Microphone Volume	0 ~ 30	15	

USER CONTROLS

Options Menu



Item	Value/Range	Default	Remark
Logo	Default/User	Default	
Logo Capture			
Auto Source	On/Off	On	
Input			
Auto Power Off (Min)	0~120	20	
LASER Settings			
High Altitude	On/Off	Off	
Filters Remind (Hour)		300	
Information			

USER CONTROLS

3D Menu

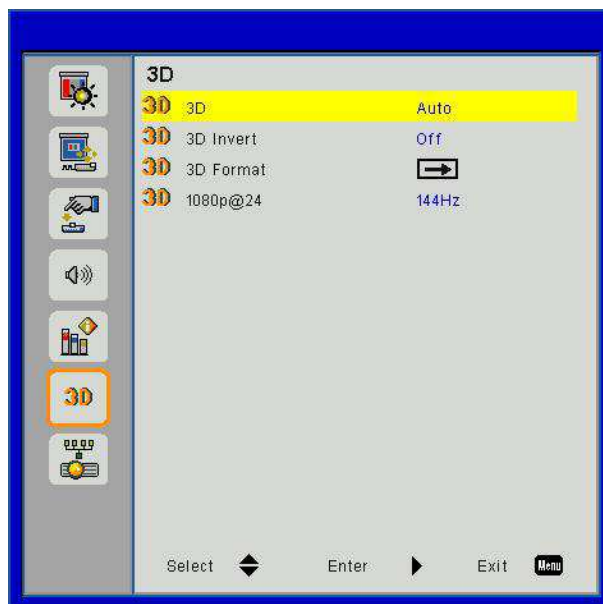

Item	Value/Range	Default	Remark
3D	Auto / On /Off	Auto	
3D Invert	On / Off	Off	
3D Format			
1080p@24	144Hz / 96Hz	144Hz	

USER CONTROLS

LAN menu

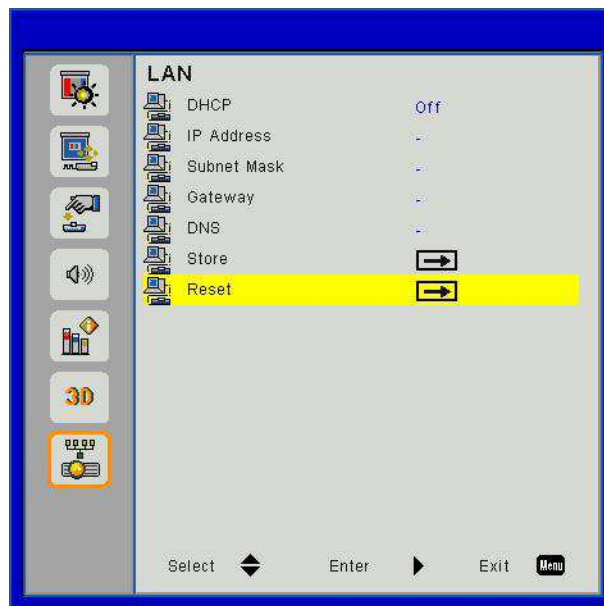

Item	Value/Range	Default	Remark
DHCP	On / off	Off	
Ip Address	0.0.0.0 ~ 255.255.255.255	192.168.10.100	
Subnet Mask	0.0.0.0 ~ 255.255.255.255	255.255.255.0	
Gateway	0.0.0.0 ~ 255.255.255.255	192.168.10.1	
DNS	0.0.0.0 ~ 255.255.255.255	0.0.0.0	
Store			
Reset			

USER CONTROLS

Picture

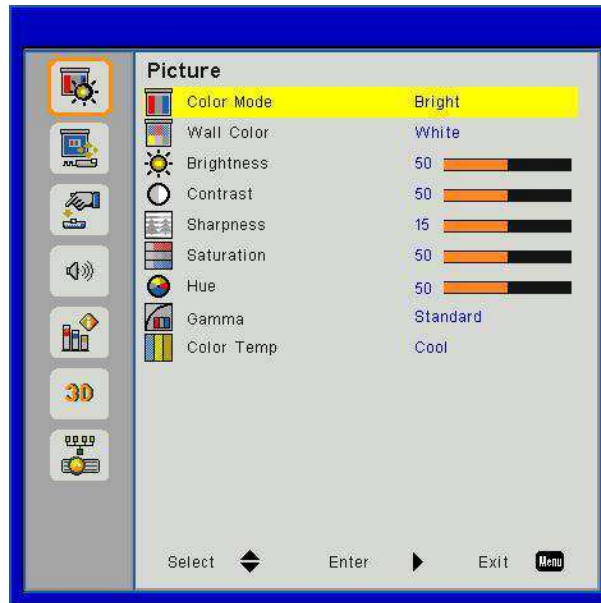

Color Mode

There are many factory presets optimized for various types of images. Use the ◀ or ▶ button to select the item.

- Bright: For brightness optimization.
- PC: For meeting presentation.
- Movie: For playing video content.
- Game: For game content.
- User: Memorize user's settings.

Wall Color

Use this function to obtain an optimized screen image according to the wall color. You can select from "White", "Light Yellow", "Light Blue", "Pink", and "Dark Green".

Brightness

Adjust the brightness of the image.

- Press the ◀ button to darken image.
- Press the ▶ button to brighten image.

Contrast

The Contrast controls the difference between the lightest and darkest parts of the picture. Adjusting the contrast changes the amount of black and white in the image.

- Press the ◀ button to decrease the contrast.
- Press the ▶ button to increase the contrast.

Sharpness

Adjust the sharpness of the image.

- Press the ◀ button to decrease the sharpness.
- Press the ▶ button to increase the sharpness.

USER CONTROLS

Saturation

Adjust a video image from black and white to fully saturated color.

- Press the ◀ button to decrease the amount of saturation in the image.
- Press the ▶ button to increase the amount of saturation in the image.

Note: “Sharpness”, “Saturation” and “Hue” functions are only supported under video mode.

Hue

Adjust the color balance of red and green.

- Press the ◀ button to increase the amount of green in the image.
- Press the ▶ button to increase the amount of red in the image.

Gamma

This allows you to adjust the gamma value to obtain the better image contrast for the input.

Color Temp

This allows you to adjust the color temperature. At higher temperature, the screen looks colder; at lower temperature, the screen looks warmer.

USER CONTROLS

Screen

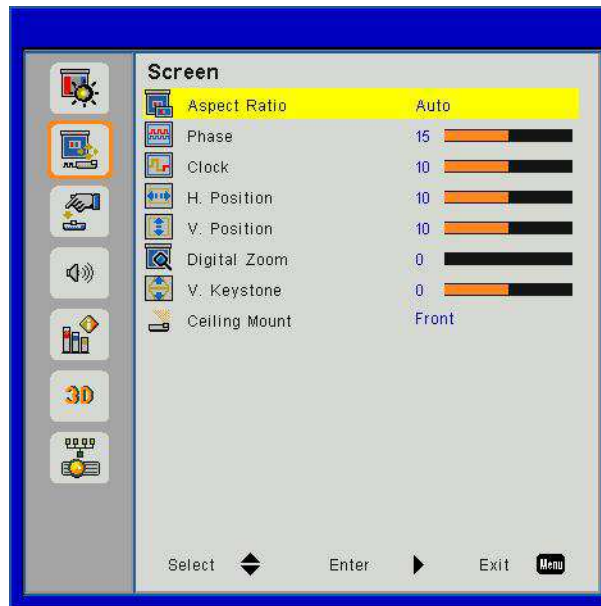

Aspect Ratio

- Auto: Keep the image with original width-height ratio and maximize the image to fit native horizontal or vertical pixels.
- 4:3: The image will be scaled to fit the screen and displayed using a 4:3 ratio.
- 16:9: The image will be scaled to fit the width of the screen and the height adjusted to display the image using a 16:9 ratio.
- 16:10: The image will be scaled to fit the width of the screen and the height adjusted to display the image using a 16:10 ratio.

Phase

Synchronize the signal timing of the display with the graphic card. If the image appears to be unstable or flickers, use this function to correct it.

Note: "H. Position" and "V. Position" ranges will depend on input source.

Clock

Adjust to achieve an optimal image when there is a vertical flicker in the image.

H. Position

- Press the ◀ button to move the image left.
- Press the ▶ button to move the image right.

V. Position

- Press the ◀ button to move the image down.
- Press the ▶ button to move the image up.

Digital Zoom

- Press the ◀ button to reduce the size of an image.
- Press the ▶ button to magnify an image on the projection screen.

USER CONTROLS

V Keystone

Press the ◀ or ▶ button to adjust image distortion vertically. If the image looks trapezoidal, this option can help make the image rectangular.

Ceiling Mount

- Front: The image is projected straight on the screen.
- Front Ceiling: This is the default selection. When selected, the image will turn upside down.
- Rear: When selected, the image will appear reversed.
- Rear Ceiling: When selected, the image will appear reversed in upside down position.

USER CONTROLS

Settings



Language

Choose the multilingual OSD menu. Press the ◀ or ▶ button into the sub menu and then use the ▲ or ▼ button to select your preferred language. Press ▶ on the remote control to finalize the selection.



Menu Location

Choose the menu location on the display screen.

Closed Caption

Use this function to enable close caption menu. Select an appropriate closed captions option: Off, CC1, CC2, CC3, and CC4.

VGA Output (Standby)

Choose “On” to enable VGA OUT connection.

VGA-2 (Function)

- Input: Choose “Input” to let the VGA port works as a VGA input function.
- Output: Choose “Output” to enable the VGA Out function once the projector is powered on.

Test Pattern

Display a test pattern.

USER CONTROLS

Signal Power On

If Signal Power On is set to ON the projector will wake up automatically from standby mode if the input source is changed from inactive to active.

Reset

Choose “Yes” to return the parameters on all menus to the factory default settings.

USER CONTROLS

Volume

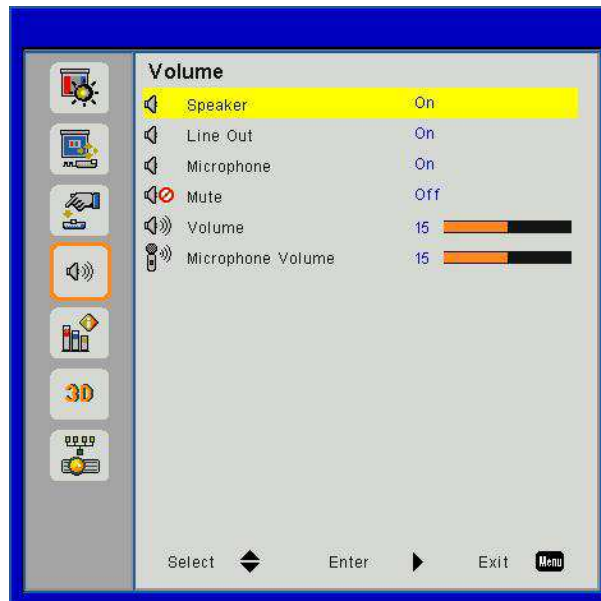

Speaker

- Choose “On” to enable the speaker.
- Choose “Off” to disable the speaker.

Line Out

- Choose “On” to enable the line out function.
- Choose “Off” to disable the line out function.

Microphone

- Choose “On” to enable the microphone.
- Choose “Off” to disable the microphone.

Mute

- Choose “On” to turn mute on.
- Choose “Off” to turn mute off.

Volume

- Press the ◀ button to decrease the volume.
- Press the ▶ button to increase the volume.

Microphone Volume

- Press the ◀ button to decrease the microphone volume.
- Press the ▶ button to increase the microphone volume.

USER CONTROLS

Options

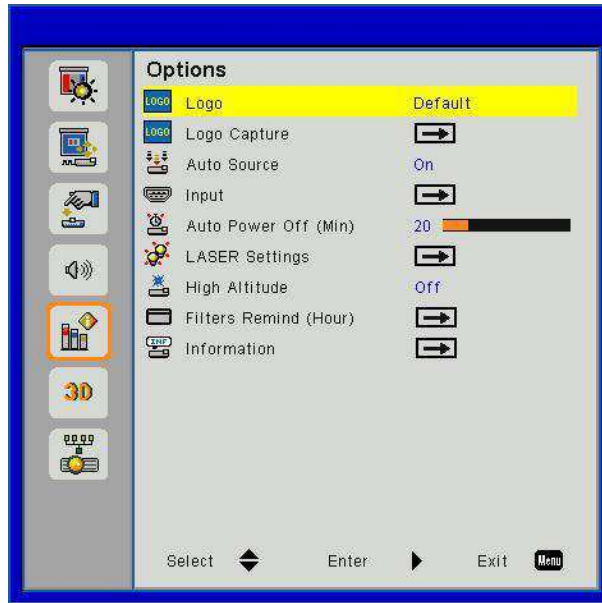

Logo

Use this function to set the desired startup screen. If changes are made they will take effect the next time the projector is powered on.

- Default: The default startup screen.
- User: Use stored picture from “Logo Capture” function.

Logo Capture

Press ► button to capture an image of the picture currently displayed on screen.

Note:

For successful logo capture, please ensure that the on-screen image does not exceed the projector’s native resolution. (WXGA:1280x800).

“Logo Capture” is not available when 3D is enabled.

Before active this function, it is recommended that “Aspect Ratio” is set to the “Auto”.

Auto Source

- On: The projector will search for other signals if the current input signal is lost.
- Off: The projector will only search current input connection.

Input

Press ► button to enable/disable input sources. The projector will not search for inputs that are not selected.

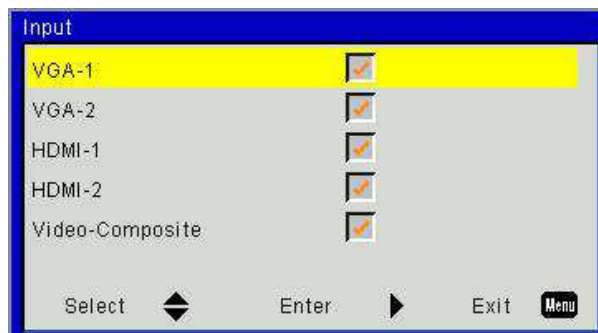

USER CONTROLS

Auto Power Off (Min)

Sets the countdown timer interval. The countdown timer will start, when there is no signal being sent to the projector. The projector will automatically power off when the countdown has finished (in minutes).

LASER Settings

Refer to page 32.

High Altitude

- On: The built-in fans run at high speed. Select this option when using the projector at altitudes above 2500 feet/762 meters or higher.
- Off: The built-in fans automatically run at a variable speed according to the internal temperature.

Filters Remind (Hour)

- Filters Remind (Hour): Set the filter reminder time.
- Cleaning Up Remind: Select "Yes" to reset the dust filter hour counter after replacing or cleaning the dust filter.



Information

Display the projector information for model name, SNID, source, resolution, software version, and aspect ratio on the screen.

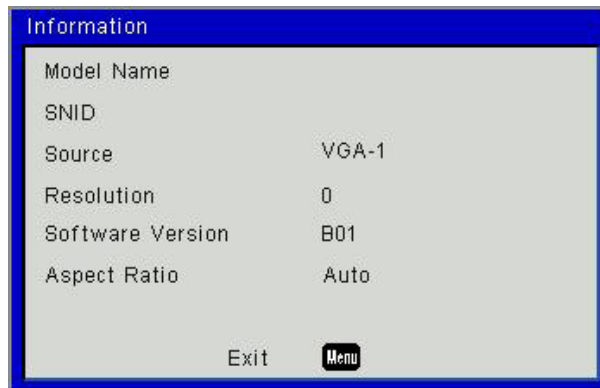

USER CONTROLS

Options | LASER Settings

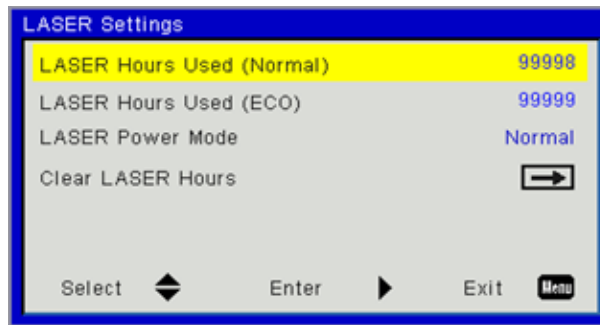

LASER Hours Used (Normal)

Display the projection time of normal mode.

LASER Hours Used (ECO)

Display the projection time of ECO mode.

LASER Power Mode

- Normal: Normal mode.
- ECO: Use this function to dim the projector lamp which will lower power consumption and extend the lamp life.

Clear LASER Hours

Choose "Yes" to reset the laser hour counter.

USER CONTROLS

3D

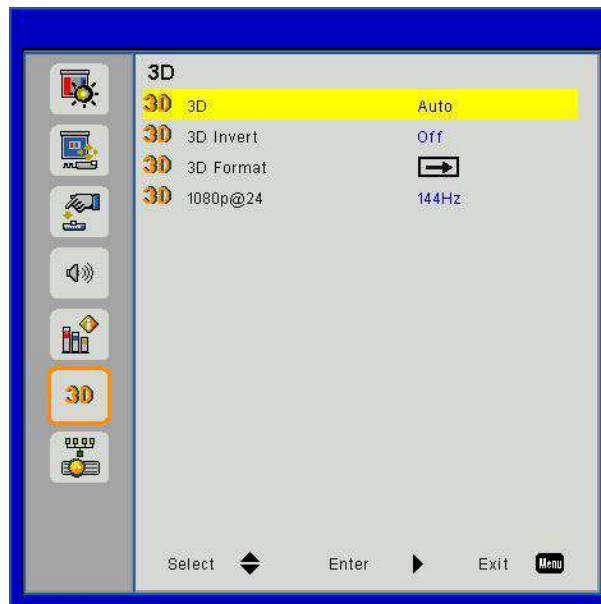

3D

- Auto: When a HDMI 1.4a 3D timing identification signal is detected, the 3D image is selected automatically.
- Choose “On” to enable 3D function.
- Choose “Off” to disable 3D function.

3D Invert

If you see a discrete or overlapping image while wearing DLP 3D glasses, you may need to execute “Invert” to get best match of left/right image sequence to get the correct image.

3D Format

Use this feature to select the 3D format. Options are: “Frame Packing”, “Side-by-Side (Half)”, “Top and Bottom”, “Frame Sequential”, and “Field Sequential”.

Note:

“Frame Packing” is supported the DLP Link 3D input signals from VGA / HDMI connector.

“Frame Sequential” / “Field Sequential” are supported the HQFS 3D input signals from Composite/S-Video connector connector.

“Frame Packing” / “Side-by-Side(Half)” / “Top and Bottom” are supported from HDMI 1.4a 3D input signals.

1080p@24

Use this feature to select 96 or 144Hz refresh rate as using 3D glasses in the 1080p @ 24 frame packing.

USER CONTROLS

LAN

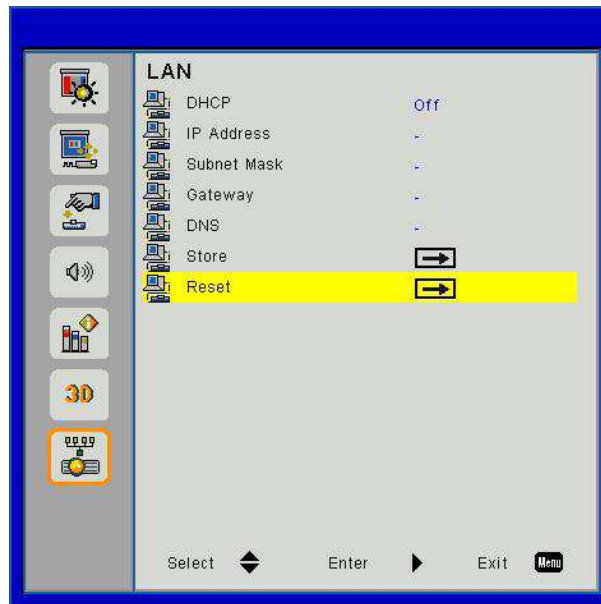

DHCP

If a DHCP server exists in the network to which the projector is connected, the IP address will automatically be acquired when you select DHCP On. If DHCP is Off, manually set the IP Address, Subnet Mask, and Gateway. Use ▲ or ▼ to select the number of IP address, Subnet Mask, and Gateway.

IP Address

Select an IP address.

Subnet Mask

Configure the Subnet Mask of the LAN connection.

Gateway

Check the Gateway address with your network/system administrator if you configure it manually.

DNS

Check the DNS Server IP address with your network/system administrator if you configure it manually.

Store

Choose “Yes” to save the changes made in network configuration settings.

Reset

Choose “Yes” to return the display parameters on all menus to the factory default settings.

APPENDICES

Installing and Cleaning the Optional Dust Filter

We recommend you clean the dust filter every 500 hours of operation, or more often if you are using the projector in a dusty environment.

When the warning message appears on the screen, do the following to clean the air filter:



Note:

The optional dust filter should be used in dusty environments.

If the dust filter is installed, a proper maintenance will prevent overheating and projector malfunction.

The dust filter is optional.

The specific interfaces are selected in terms of the specifications of types.

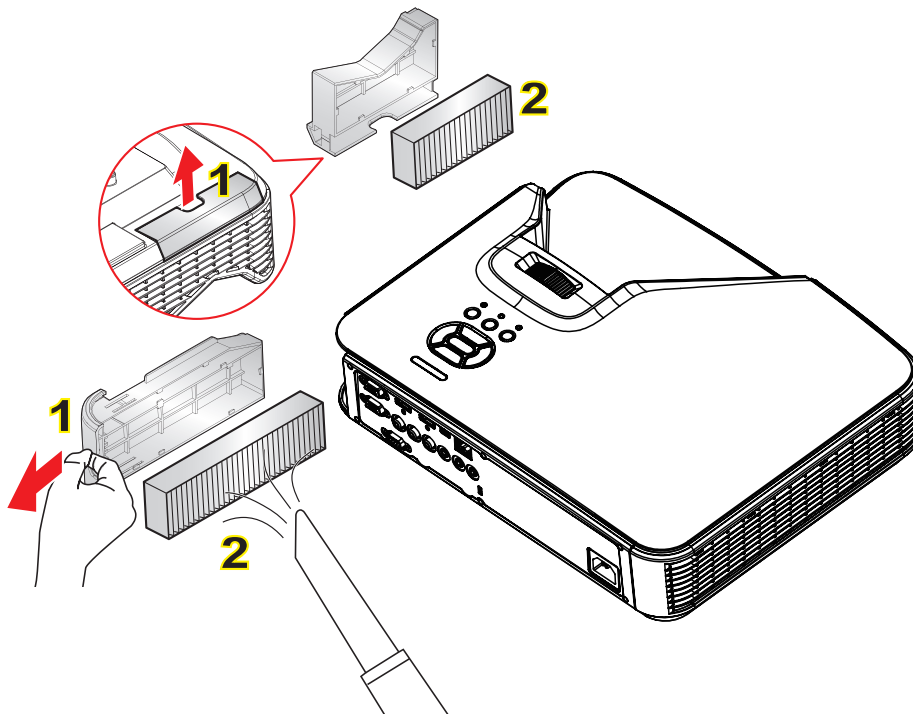

Air Filter Cleaning Procedure:

1. Switch off the power to the projector by pressing the "⏻" button.
2. Disconnect the power cord.
3. Pull out the dust filter, as shown in the illustration. **1**
4. Carefully remove the dust filter. Then clean or change the filter. **2**

To install the filter, reverse the previous steps.

5. Turn on the projector and reset the filter usage counter after the dust filter is replaced.

APPENDICES

Specification

Optical	Description
Optical Resolutions	XGA: 1024 x 768 (4:3)
	WXGA: 1280 x 800 (16:10)
Digital Resolution	1920 x 1200 / 60Hz
Lens	Manual Zoom and Manual Focus
DLP	XGA 0.55 DMD Chip
	WXGA 0.65 DMD Chip
Brightness	XGA: 3000 Lumens (Regular)
	WXGA: 3200 Lumens (Regular)
Image Size (Diagonal)	XGA: 60"~100"
	WXGA: 70"~100"
Projection Distance	XGA: 0.75~1.33
	WXGA: 0.779~1.127

Specification	Description
Connection Port (Input)	HDMI Signal Input x 2, Mini USB (Firmware Upgrade), RS-232C, VGA Signal Input, Composite, RJ45, Microphone, Audio Input (3.5 mm Jack)
Connection Port (Output)	VGA Signal Output, Audio Output (3.5 mm Jack)
Wired LAN Connection Port	RJ45
Maintenance Connection Port	RS232 Connector
Scan Rate	Horizontal Scan Rate: 15.375 ~ 91.146 KHz
	Vertical Scan Rate: 24 ~ 85Hz (3D for 120Hz)
Synchronized Compatibility	Standalone Synchronization
Built-in Speakers	10 Watts
Power Requirements	AC 100 – 240V 50/60 Hz
Input Current	3.5A
LAN Speed - Upper Limit	100Mbps
Power Consumption	Regular Mode: 265W ± 15%
	Power Saving Mode: 195W ± 15%
	Standby Mode: No Network Connection in Standby Mode: < 0.5W

Mechanical	Description
Size	383 x 308 x 85 (W x D x H) mm, excluding Adjustable Leveling Foot/Screw
Weight	5.5 Kg
Operating Environment	In Operation: 5 ~ 40°C Bright Mode (Regular Mode)
	Humidity 10% to 85% (Non-condensing)

APPENDICES

Compatibility Modes

VGA Analog

a. PC signal			
Modes	Resolution	V. Frequency [Hz]	H. Frequency [Hz]
VGA	640x480	60	31.5
	640x480	67	35.0
	640x480	72	37.9
	640x480	75	37.5
	640x480	85	43.3
	640x480	120	61.9
IBM	720x400	70	31.5
SVGA	800x600	56	35.1
	800x600	60	37.9
	800x600	72	48.1
	800x600	75	46.9
	800x600	85	53.7
	800x600	120	77.4
Apple, MAC II	832x624	75	49.1
XGA	1024x768	60	48.4
	1024x768	70	56.5
	1024x768	75	60.0
	1024x768	85	68.7
	1024x768	120	99.0
Apple, MAC II	1152x870	75	68.7
SXGA	1280x1024	60	64.0
	1280x1024	72	77.0
	1280x1024	75	80.0
QuadVGA	1280x960	60	60.0
	1280x960	75	75.2
SXGA+	1400x1050	60	65.3
UXGA	1600x1200	60	75.0
b. Extended wide timing			
Modes	Resolution	V. Frequency [Hz]	H. Frequency [Hz]
WXGA	1280x720	60	44.8
	1280x800	60	49.6
	1366x768	60	47.7
	1440x900	60	59.9
WSXGA+	1680x1050	60	65.3

APPENDICES

c. Component signal			
Modes	Resolution	V. Frequency [Hz]	H. Frequency [Hz]
480i	720x480 (1440x480)	59.94 (29.97)	15.7
576i	720x576 (1440x576)	50 (25)	15.6
480p	720x480	59.94	31.5
576p	720x576	50	31.3
720p	1280x720	60	45.0
	1280x720	50	37.5
1080i	1920x1080	60 (30)	33.8
	1920x1080	50 (25)	28.1
1080p	1920x1080	23.98/24	27.0
	1920x1080	60	67.5
	1920x1080	50	56.3

HDMI Digital

a. PC signal			
Modes	Resolution	V. Frequency [Hz]	H. Frequency [Hz]
VGA	640x480	60	31.5
	640x480	67	35.0
	640x480	72	37.9
	640x480	75	37.5
	640x480	85	43.3
	640x480	120	61.9
IBM	720x400	70	31.5
SVGA	800x600	56	35.1
	800x600	60	37.9
	800x600	72	48.1
	800x600	75	46.9
	800x600	85	53.7
	800x600	120	77.4
Apple, MAC II	832x624	75	49.1
XGA	1024x768	60	48.4
	1024x768	70	56.5
	1024x768	75	60.0
	1024x768	85	68.7
	1024x768	120	99.0
Apple, MAC II	1152x870	75	68.7
SXGA	1280x1024	60	64.0
	1280x1024	72	77.0
	1280x1024	75	80.0
QuadVGA	1280x960	60	60.0
	1280x960	75	75.2
SXGA+	1400x1050	60	65.3
UXGA	1600x1200	60	75.0

APPENDICES

b. Extended Frequency			
Modes	Resolution	V. Frequency [Hz]	H. Frequency [Hz]
WXGA	1280x720	60	44.8
	1280x800	60	49.6
	1366x768	60	47.7
	1440x900	60	59.9
WSXGA+	1680x1050	60	65.3
c. Video signal			
Modes	Resolution	V. Frequency [Hz]	H. Frequency [Hz]
480p	640x480	59.94/60	31.5
480i	720x480 (1440x480)	59.94 (29.97)	15.7
576i	720x576 (1440x576)	50(25)	15.6
480p	720x480	59.94	31.5
576p	720x576	50	31.3
720p	1280x720	60	45.0
	1280x720	50	37.5
1080i	1920x1080	60 (30)	33.8
	1920x1080	50 (25)	28.1
1080p	1920x1080	23.98/24	27.0
	1920x1080	60	67.5
	1920x1080	50	56.3
d. HDMI 1.4a (3D Signal)			
Modes	Resolution	V. Frequency [Hz]	H. Frequency [Hz]
Frame Packing	720p	50	31.5
	720p	59.94/60	15.7
	1080p	23.98/24	15.6
Side-by-Side (Half)	1080i	50	31.5
	1080i	59.94/60	31.3
Top and Bottom	720p	50	45.0
	720p	59.94/60	37.5
	1080p	23.98/24	33.8

APPENDICES

RS232 Commands and Protocol Function List

RS232 Port Setting

Items	Method
Communication Method	Asynchronous Communication
Bits per seconds	19200
Data bits	8 bits
Parity	None
Stop bits	1
Flow control	None

RS232 Signals Connection

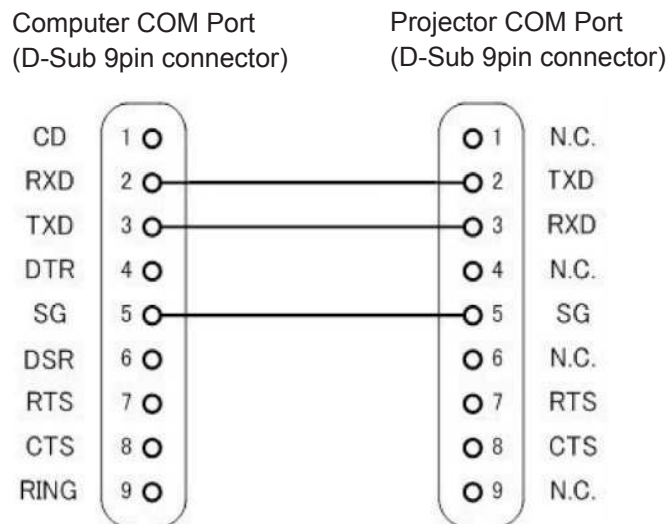

Note: RS232 shell is grounded.

APPENDICES

RS232 Commands Set List

RS232 commands as follows, each command end by [CR](Carriage Returns)

Projector Return (Pass): P	XX=00 is for all projectors		
Projector Return (Fail): F			
SEND to projector			
232 ASCII Code	HX3070U Code	Function	Description
~XX00 1	7E 30 30 30 30 20 31 0D	Power ON	
~XX00 0	7E 30 30 30 30 20 30 0D	Power OFF	
~XX01 1	7E 30 30 30 31 20 31 0D	Resync	
~XX02 1	7E 30 30 30 32 20 31 0D	AV Mute(Blank)	On
~XX02 0	7E 30 30 30 32 20 30 0D		Off
~XX03 1	7E 30 30 30 33 20 31 0D	Mute	On
~XX03 0	7E 30 30 30 33 20 30 0D		Off
~XX04 1	7E 30 30 30 34 20 31 0D	Freeze	
~XX04 0	7E 30 30 30 34 20 30 0D	Unfreeze	
~XX05 1	7E 30 30 30 35 20 31 0D	Zoom Plus	
~XX06 1	7E 30 30 30 36 20 31 0D	Zoom Minus	
~XX12 1	7E 30 30 31 32 20 31 0D	Direct Source	HDMI 1
~XX12 5	7E 30 30 31 32 20 35 0D		VGA 1
~XX12 6	7E 30 30 31 32 20 36 0D		VGA 2
~XX12 10	7E 30 30 31 32 20 31 30 0D		Video
~XX12 15	7E 30 30 31 32 20 31 35 0D		HDMI 2
~XX20 1	7E 30 30 32 30 20 31 0D	Color Mode	Bright
~XX20 2	7E 30 30 32 30 20 32 0D		PC
~XX20 3	7E 30 30 32 30 20 33 0D		Movie
~XX20 4	7E 30 30 32 30 20 34 0D		Game
~XX20 5	7E 30 30 32 30 20 35 0D		User
~XX21 n	7E 30 30 32 31 20 a 0D	Brightness	n = 0 (a=30) ~ 100 (a=31 30 30)
~XX22 n	7E 30 30 32 32 20 a 0D	Contrast	n = 0 (a=30) ~ 100 (a=31 30 30)
~XX23 n	7E 30 30 32 33 20 a 0D	Sharpness	n = 0 (a=30) ~ 31 (a=33 31)
~XX60 1	7E 30 30 36 30 20 31 0D	Format(aspect ratio)	4:3
~XX60 2	7E 30 30 36 30 20 32 0D		16:9
~XX60 3	7E 30 30 36 30 20 33 0D		16:10
~XX60 7	7E 30 30 36 30 20 37 0D		AUTO
~XX66 n	7E 30 30 36 36 20 a 0D	Keystone	n = -40/40
~XX70 1	7E 30 30 37 30 20 31 0D	Language	English
~XX70 2	7E 30 30 37 30 20 32 0D		German
~XX70 3	7E 30 30 37 30 20 33 0D		French
~XX70 4	7E 30 30 37 30 20 34 0D		Italian
~XX70 5	7E 30 30 37 30 20 35 0D		Spanish
~XX70 6	7E 30 30 37 30 20 36 0D		Portuguese
~XX70 7	7E 30 30 37 30 20 37 0D		Polish
~XX70 8	7E 30 30 37 30 20 38 0D		Dutch
~XX70 9	7E 30 30 37 30 20 39 0D		Swedish
~XX70 10	7E 30 30 37 30 20 31 30 0D		Norwegian
~XX70 13	7E 30 30 37 30 20 31 33 0D		Traditional Chinese
~XX70 14	7E 30 30 37 30 20 31 34 0D		Simplified Chinese
~XX70 15	7E 30 30 37 30 20 31 35 0D		Japanese
~XX70 16	7E 30 30 37 30 20 31 36 0D		Korean
~XX70 17	7E 30 30 37 30 20 31 37 0D		Russian
~XX70 20	7E 30 30 37 30 20 32 30 0D		Arabic
~XX70 22	7E 30 30 37 30 20 32 32 0D		Turkish
~XX70 24	7E 30 30 37 30 20 32 34 0D		Danish
~XX71 1	7E 30 30 37 31 20 31 0D	Projection(ceiling M)	Front-Desktop
~XX71 2	7E 30 30 37 31 20 32 0D		Rear-Desktop
~XX71 3	7E 30 30 37 31 20 33 0D		Front-Ceiling
~XX71 4	7E 30 30 37 31 20 34 0D		Rear-Ceiling
~XX72 1	7E 30 30 37 32 20 31 0D	Menu Location	Top Left
~XX72 2	7E 30 30 37 32 20 32 0D		Top Right
~XX72 3	7E 30 30 37 32 20 33 0D		Centre

APPENDICES

~XX72 4	7E 30 30 37 32 20 34 0D		Bottom Left	
~XX72 5	7E 30 30 37 32 20 35 0D		Bottom Right	
~XX80 n	7E 30 30 38 30 20 a 0D	Mute	n = 1/0 (On/Off)	
~XX81 n	7E 30 30 38 31 20 a 0D	Volume	n = 0 (a=30) ~ 30 (a=33 30)	
~XX101 n	7E 30 30 31 30 31 20 a 0D	High Altitude	n = 0/1 (a=30/31)	
~XX106 n	7E 30 30 31 30 36 20 a 0D	Auto Power Off (min)	n = 0 (a=30) ~ 120 (a=31 32 30), step=5	
~XX318 n	7E 30 30 33 31 38 20 a 0D	Microphone Volume	n = 0 (a=30) ~ 30 (a=33 30)	
~XX112 1	7E 30 30 31 31 32 20 31 0D	Reset	Yes	
~XX140 10	7E 30 30 31 34 30 20 31 30 0D	Up		
~XX140 11	7E 30 30 31 34 30 20 31 31 0D	Left		
~XX140 13	7E 30 30 31 34 30 20 31 33 0D	Right		
~XX140 14	7E 30 30 31 34 30 20 31 34 0D	Down		
~XX140 15	7E 30 30 31 34 30 20 31 35 0D	Keystone+		
~XX140 16	7E 30 30 31 34 30 20 31 36 0D	Keystone-		
~XX140 17	7E 30 30 31 34 30 20 31 37 0D	Volume-		
~XX140 18	7E 30 30 31 34 30 20 31 38 0D	Volume+		
~XX140 20	7E 30 30 31 34 30 20 32 30 0D	Menu		
~XX140 29	7E 30 30 31 34 30 20 32 39 0D	Source		
READ to projector				
232 ASCII Code	HX3070U Code	Function	Projector Returns	Description
~XX121 1	7E 30 30 31 32 31 20 31 0D	Input Source(curr. src)	OKn	n : 0/2/3/5/7/8 = None / VGA1 / VGA2 / Video / HDMI1 / HDMI2
~XX122 1	7E 30 30 31 32 32 20 31 0D	Software Version	OKddd	ddd: FW version
~XX123 1	7E 30 30 31 32 33 20 31 0D	Display Mode	OKn	n: 1/2/3/4/5 = Bright/PC/Movie/Game/User
~XX127 1	7E 30 30 31 32 37 20 31 0D	Aspect Ratio	OKn	n: 1/2/3/7 = 4:3 / 16:9 / 16:10 / AUTO
~XX150 1	7E 30 30 31 35 30 20 31 0D	Information	Okabbbbccdddee	a : Power Status / b : LD Hour / c : Input Source / d : Firmware Version / e : Color mode

APPENDICES

Ceiling Mount Installation

If you want to use a third-party ceiling mount kit, please ensure the screw used to attach the mount to the projector meet the following specifications:

- Screw type: M4*4
- Minimum screw length: 10mm

Note: Damages resulting from incorrect installation are not covered under warranty.

Warning:

1. If you buy a ceiling mount from other companies, please be sure to use the correct screw size. Screw size will vary according to the thickness of the mounting plates.
2. Be sure to keep a gap of at least 10 cm between the ceiling and the bottom of the projector.
3. Avoid installing the projector near a heat source.

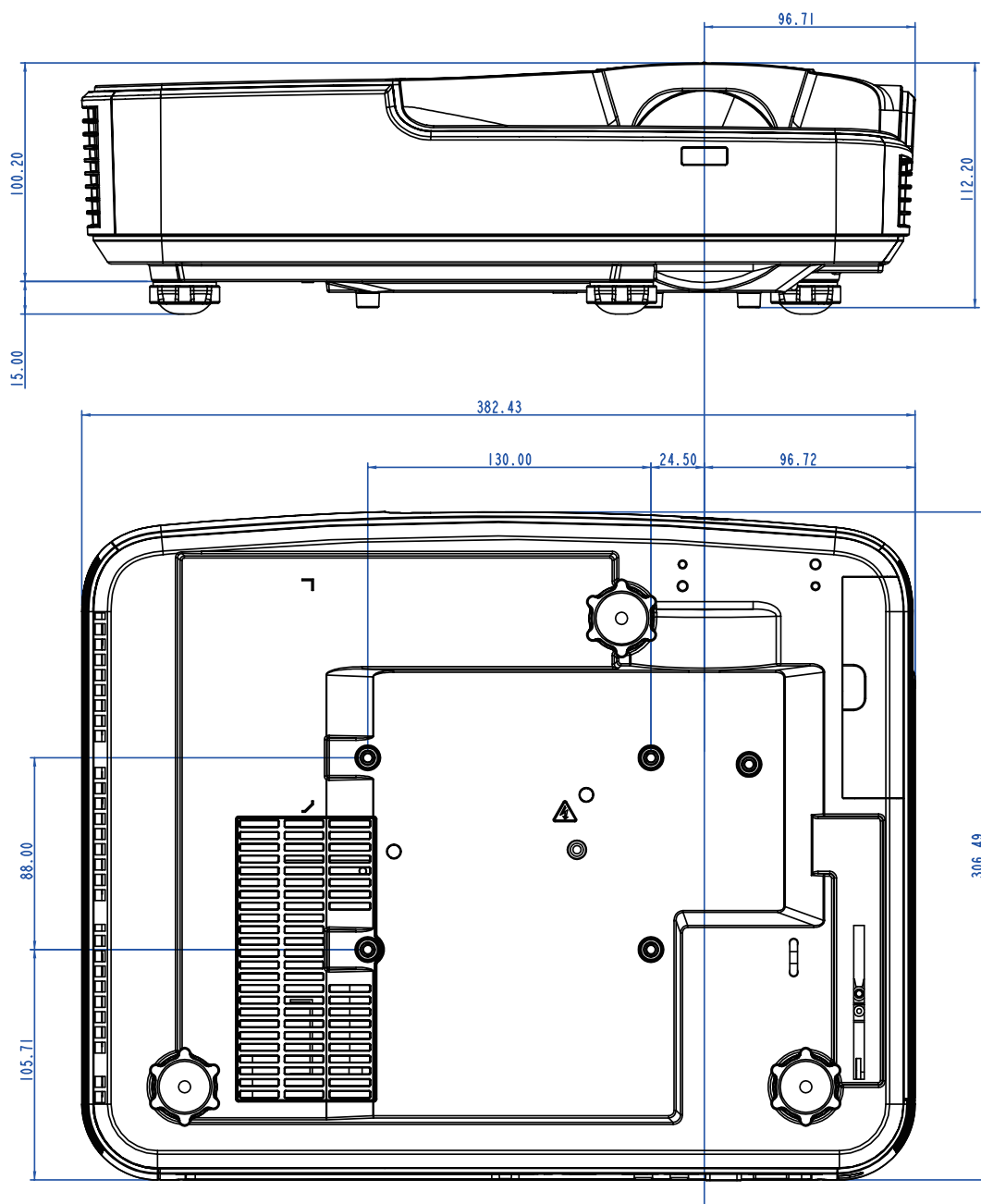

APPENDICES

Optoma global offices

For service or support, please contact your local office.

USA

Optoma Technology, Inc.
47697 Westinghouse Drive.
Fremont, Ca 94539
www.optomausa.com

☎ 888-289-6786
📠 510-897-8601
✉ services@optoma.com

Canada

Optoma Technology, Inc.
47697 Westinghouse Drive.
Fremont, Ca 94539
www.optomausa.com

☎ 888-289-6786
📠 510-897-8601
✉ services@optoma.com

Latin America

Optoma Technology, Inc.
47697 Westinghouse Drive.
Fremont, Ca 94539
www.optomausa.com

☎ 888-289-6786
📠 510-897-8601
✉ services@optoma.com

Europe

Unit 1, Network 41, Bourne End Mills
Hemel Hempstead, Herts,
HP1 2UJ, United Kingdom
www.optoma.eu
Service Tel : +44 (0)1923 691865

☎ +44 (0) 1923 691 800
📠 +44 (0) 1923 691 888
✉ service@tsc-europe.com

Benelux BV

Randstad 22-123
1316 BW Almere
The Netherlands
www.optoma.nl

☎ +31 (0) 36 820 0252
📠 +31 (0) 36 548 9052

France

Bâtiment E
81-83 avenue Edouard Vaillant
92100 Boulogne Billancourt,
France

☎ +33 1 41 46 12 20
📠 +33 1 41 46 94 35
✉ savoptoma@optoma.fr

Spain

C/ José Hierro,36 Of. 1C
28522 Rivas VaciaMadrid,
Spain

☎ +34 91 499 06 06
📠 +34 91 670 08 32

Deutschland

Wiesenstrasse 21 W
D40549 Düsseldorf,
Germany

☎ +49 (0) 211 506 6670
📠 +49 (0) 211 506 66799
✉ info@optoma.de

Scandinavia

Lerpeveien 25
3040 Drammen
Norway

☎ +47 32 98 89 90
📠 +47 32 98 89 99
✉ info@optoma.no

PO.BOX 9515
3038 Drammen
Norway

Korea

WOOMI TECH.CO.,LTD.
4F,Minu Bldg.33-14, Kangnam-Ku,
seoul,135-815, KOREA

☎ +82+2+34430004
📠 +82+2+34430005

Japan

東京都足立区綾瀬3-25-18
株式会社オーエス
コンタクトセンター:0120-380-495

✉ info@os-worldwide.com
www.os-worldwide.com

Taiwan

12F., No. 213,Sec. 3, Beixin Rd.,
Xindian Dist., New Taipei City 231,
Taiwan, R.O.C.
www.optoma.com.tw

☎ +886-2-8911-8600
📠 +886-2-8911-6550
✉ services@optoma.com.tw
asia.optoma.com

Hong Kong

Unit A, 27/F Dragon Centre,
79 Wing Hong Street,
Cheung Sha Wan,
Kowloon, Hong Kong

☎ +852-2396-8968
📠 +852-2370-1222
www.optoma.com.hk

China

5F, No. 1205, Kaixuan Rd.,
Changning District
Shanghai, 200052, China

☎ +86-21-62947376
📠 +86-21-62947375
www.optoma.com.cn

