



DLP® Projector

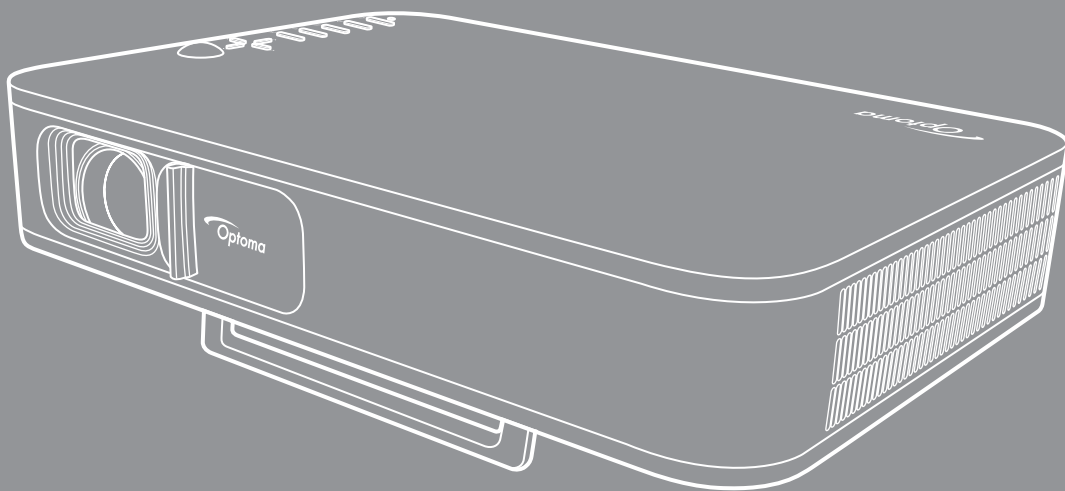



TABLE OF CONTENTS

SAFETY	3
<i>Important Safety Instruction.....</i>	<i>3</i>
<i>Copyright.....</i>	<i>4</i>
<i>Disclaimer.....</i>	<i>4</i>
<i>Trademark Recognition</i>	<i>4</i>
<i>FCC</i>	<i>5</i>
<i>Declaration of Conformity for EU countries</i>	<i>5</i>
<i>WEEE.....</i>	<i>5</i>
INTRODUCTION	6
<i>Package Overview.....</i>	<i>6</i>
<i>Standard accessories.....</i>	<i>6</i>
<i>Product Overview</i>	<i>7</i>
<i>Connections.....</i>	<i>8</i>
<i>Keypad</i>	<i>9</i>
<i>Remote control.....</i>	<i>10</i>
SETUP AND INSTALLATION	11
<i>Tripod Mount the projector.....</i>	<i>11</i>
<i>Connecting sources to the projector.....</i>	<i>12</i>
<i>Adjusting the projector image.....</i>	<i>13</i>
<i>Remote setup</i>	<i>14</i>
USING THE PROJECTOR.....	16
<i>Charging the projector built-in battery</i>	<i>16</i>
<i>Using the projector as a power bank.....</i>	<i>17</i>
<i>Powering on / off the projector.....</i>	<i>18</i>
<i>Home screen overview.....</i>	<i>19</i>
<i>Selecting an input source</i>	<i>20</i>
<i>Wireless media streaming</i>	<i>21</i>
<i>Using the USB display function</i>	<i>23</i>
<i>Connecting to a wireless speaker.....</i>	<i>25</i>
<i>Configuring the projector settings.....</i>	<i>26</i>
ADDITIONAL INFORMATION	34
<i>Compatible resolutions.....</i>	<i>34</i>
<i>Image size and projection distance</i>	<i>35</i>
<i>Projector dimensions and ceiling mount installation.....</i>	<i>36</i>
<i>IR remote codes</i>	<i>37</i>
<i>Troubleshooting.....</i>	<i>38</i>
<i>LED lightning messages.....</i>	<i>40</i>
<i>Specifications</i>	<i>40</i>
<i>Optoma global offices.....</i>	<i>41</i>

SAFETY

	The lightning flash with arrow head within an equilateral triangle is intended to alert the user to the presence of uninsulated "dangerous voltage" within the product's enclosure that may be of sufficient magnitude to constitute a risk of electric shock to persons.
	The exclamation point within an equilateral triangle is intended to alert the user to the presence of important operating and maintenance (servicing) instructions in the literature accompanying the appliance.

Please follow all warnings, precautions and maintenance as recommended in this user's guide.

Important Safety Instruction

- RG1 IEC 62471-5:2015.
- Do not block any ventilation openings. To ensure reliable operation of the projector and to protect from over heating, it is recommended to install the projector in a location that does not block ventilation. As an example, do not place the projector on a crowded coffee table, sofa, bed, etc. Do not put the projector in an enclosure such as a book case or a cabinet that restricts air flow.
- To reduce the risk of fire and/or electric shock, do not expose the projector to rain or moisture. Do not install near heat sources such as radiators, heaters, stoves or any other apparatus such as amplifiers that emits heat.
- Do not let objects or liquids enter the projector. They may touch dangerous voltage points and short out parts that could result in fire or electric shock.
- Do not use under the following conditions:
 - In extremely hot, cold or humid environments.
 - (i) Ensure that the ambient room temperature is within 5°C ~ 40°C
 - (ii) Relative humidity is 10% ~ 85%
 - In areas susceptible to excessive dust and dirt.
 - Near any appliance generating a strong magnetic field.
 - In direct sunlight.
- Do not use the unit if it has been physically damaged or abused. Physical damage/abuse would be (but not limited to):
 - Unit has been dropped.
 - Power supply cord or plug has been damaged.
 - Liquid has been spilled on to the projector.
 - Projector has been exposed to rain or moisture.
 - Something has fallen in the projector or something is loose inside.
- Do not place the projector on an unstable surface. The projector may fall over resulting in injury or the projector may become damaged.
- Do not block the light coming out of the projector lens when in operation. The light will heat the object and could melt, cause burns or start a fire.
- Please do not open or disassemble the projector as this may cause electric shock.
- Do not attempt to service the unit yourself. Opening or removing covers may expose you to dangerous voltages or other hazards. Please call Optoma before you send the unit for repair.
- See projector enclosure for safety related markings.
- The unit should only be repaired by appropriate service personnel.
- Only use attachments/accessories specified by the manufacturer.

- Do not look straight into the projector lens during operation. The bright light may harm your eyes.
- When switching the projector off, please ensure the cooling cycle has been completed before disconnecting power. Allow 90 seconds for the projector to cool down.
- Turn off and unplug the power plug from the AC outlet before cleaning the product.
- Use a soft dry cloth with mild detergent to clean the display housing. Do not use abrasive cleaners, waxes or solvents to clean the unit.
- Disconnect the power plug from AC outlet if the product is not being used for a long period of time.
- Do not setup the projector in places where it might be subjected to vibration or shock.
- Do not touch the lens with bare hands.
- Remove battery/batteries from remote control before storage. If the battery/batteries are left in the remote for long periods, they may leak.
- Do not use or store the projector in places where smoke from oil or cigarettes may be present, as it can adversely affect the quality of the projector performance.
- Please follow the correct projector orientation installation as non standard installation may affect the projector performance.
- Use a power strip and or surge protector. As power outages and brown-outs can KILL devices.

Copyright

This publication, including all photographs, illustrations and software, is protected under international copyright laws, with all rights reserved. Neither this manual, nor any of the material contained herein, may be reproduced without written consent of the author.

© Copyright 2018

Disclaimer

The information in this document is subject to change without notice. The manufacturer makes no representations or warranties with respect to the contents hereof and specifically disclaims any implied warranties of merchantability or fitness for any particular purpose. The manufacturer reserves the right to revise this publication and to make changes from time to time in the content hereof without obligation of the manufacturer to notify any person of such revision or changes.

Trademark Recognition

Kensington is a U.S. registered trademark of ACCO Brand Corporation with issued registrations and pending applications in other countries throughout the world.

HDMI, the HDMI Logo, and High-Definition Multimedia Interface are trademarks or registered trademarks of HDMI Licensing LLC in the United States and other countries.

DLP®, DLP Link and the DLP logo are registered trademarks of Texas Instruments and BrilliantColor™ is a trademark of Texas Instruments.

All other product names used in this manual are the properties of their respective owners and are Acknowledged.

FCC

This device has been tested and found to comply with the limits for a Class B digital device pursuant to Part 15 of the FCC rules. These limits are designed to provide reasonable protection against harmful interference in a residential installation. This device generates, uses and can radiate radio frequency energy and, if not installed and used in accordance with the instructions, may cause harmful interference to radio communications.

However, there is no guarantee that interference will not occur in a particular installation. If this device does cause harmful interference to radio or television reception, which can be determined by turning the device off and on is encouraged to try to correct the interference by one or more of the following measures:

- Reorient or relocate the receiving antenna.
- Increase the separation between the device and receiver.
- Connect the device into an outlet on a circuit different from that to which the receiver is connected.
- Consult the dealer or an experienced radio/television technician for help.

Notice: Shielded cables

All connections to other computing devices must be made using shielded cables to maintain compliance with FCC regulations.

Caution

Changes or modifications not expressly approved by the manufacturer could void the user's authority, which is granted by the Federal Communications Commission, to operate this projector.

Operation Conditions

This device complies with Part 15 of the FCC Rules. Operation is subject to the following two conditions:

1. This device may not cause harmful interference and
2. This device must accept any interference received, including interference that may cause undesired operation.

Notice: Canadian users

This Class B digital apparatus complies with Canadian ICES-003.

Remarque à l'intention des utilisateurs canadiens

Cet appareil numérique de la classe B est conforme à la norme NMB-003 du Canada.

Declaration of Conformity for EU countries

- EMC Directive 2014/30/EC (including amendments)
- Low Voltage Directive 2014/35/EC
- R & TTE Directive 1999/5/EC (if product has RF function)

WEEE



Disposal instructions

Do not throw this electronic device into the trash when discarding. To minimize pollution and ensure utmost protection of the global environment, please recycle it.

INTRODUCTION

Package Overview

Carefully unpack and verify that you have the items listed below under standard accessories. Some of the items under optional accessories may not be available depending on the model, specification and your region of purchase. Please check with your place of purchase. Some accessories may vary from region to region.

The warranty card is only supplied in some specific regions. Please consult your dealer for detailed information.

Standard accessories

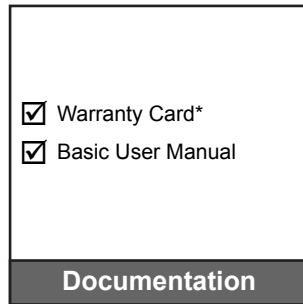
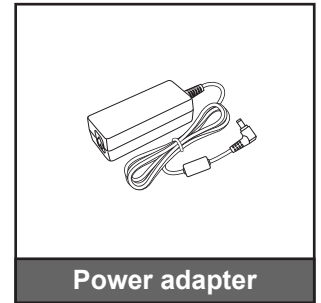
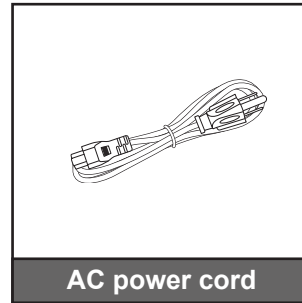
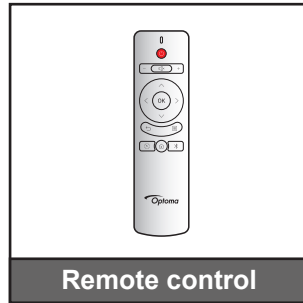
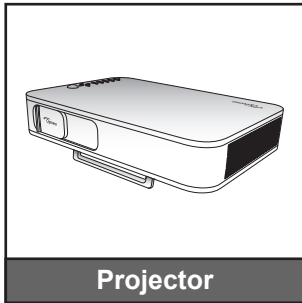

Note:

- *The remote control is shipped with the batteries.*
- ** For European warranty Information, please visit www.optoma.com.*

ProSelecta

View :: Compare :: Select - www.ProSelecta.com

INTRODUCTION

Product Overview

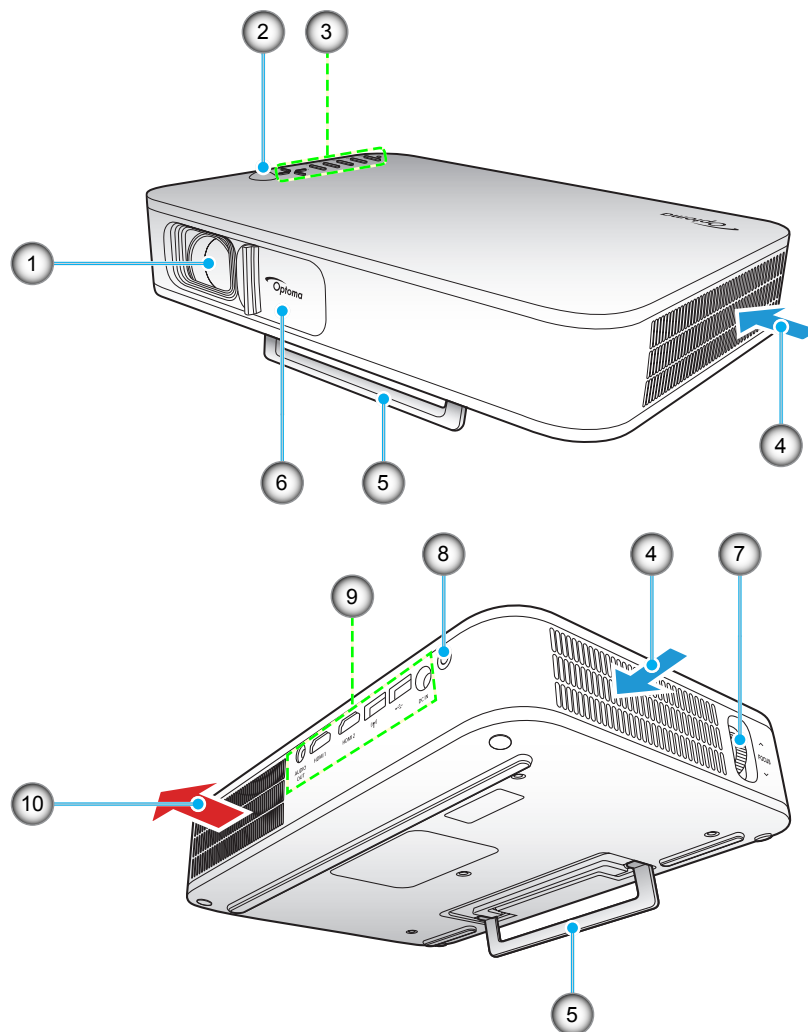

Note: Keep a minimum distance of 20 cm between the inlet and outlet vents.

No	Item	No	Item
1.	Lens	6.	Lens Cover
2.	IR Receiver	7.	Focus Ring
3.	Keypad	8.	Power Button
4.	Ventilation (inlet)	9.	Input / Output
5.	Kickstand	10.	Ventilation (outlet)

INTRODUCTION

Connections

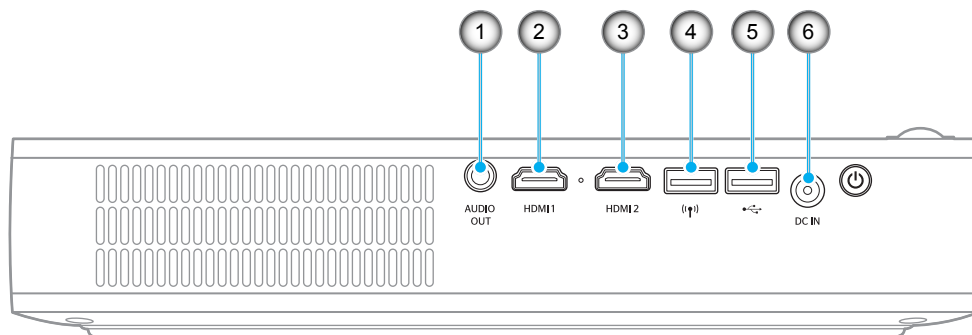

No	Item	No	Item
1.	AUDIO OUT Connector	4.	USB-A Connector (Wi-Fi dongle)
2.	HDMI 1 Connector	5.	USB-A Connector (USB display) / USB Power Out (5V/1.5A)
3.	HDMI 2 Connector	6.	DC IN Connector

INTRODUCTION

Keypad

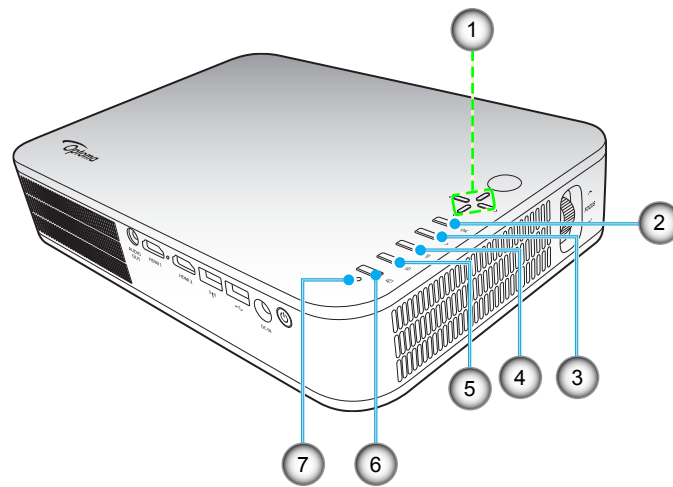

No	Item	No	Item
1.	Four Directional Select Keys	5.	Home
2.	OK	6.	Display Mode
3.	Return	7.	Status LED
4.	Settings		

INTRODUCTION

Remote control

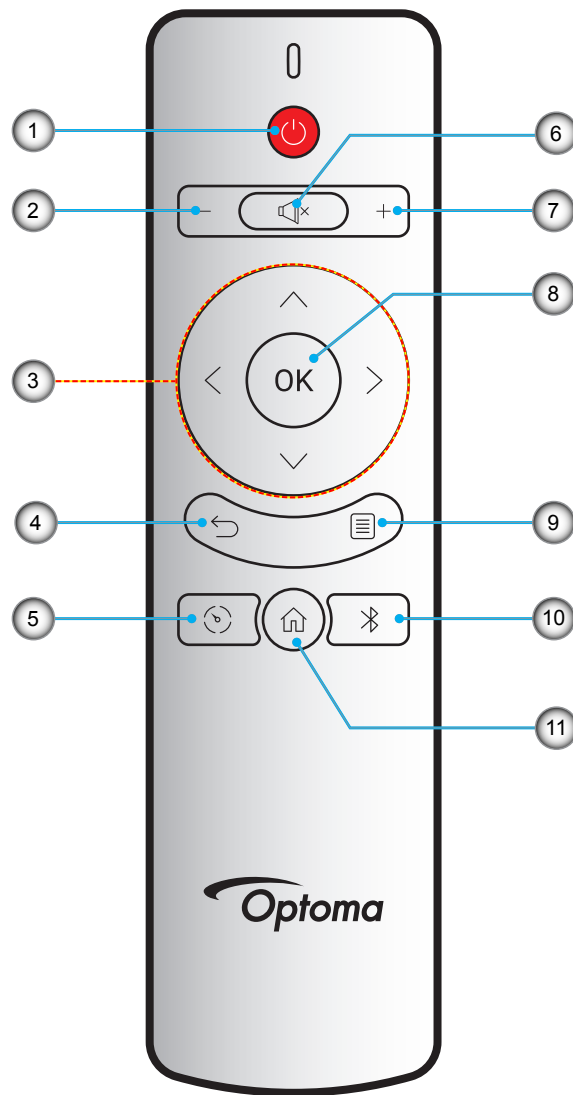

No	Item	No	Item
1.	Power On / Off	7.	Volume +
2.	Volume -	8.	OK
3.	Four Directional Select Keys	9.	Settings
4.	Return	10.	Bluetooth
5.	Display Mode	11.	Home
6.	Mute		

SETUP AND INSTALLATION

Tripod Mount the projector

Screw a standard tripod into the screw hole on the projector.

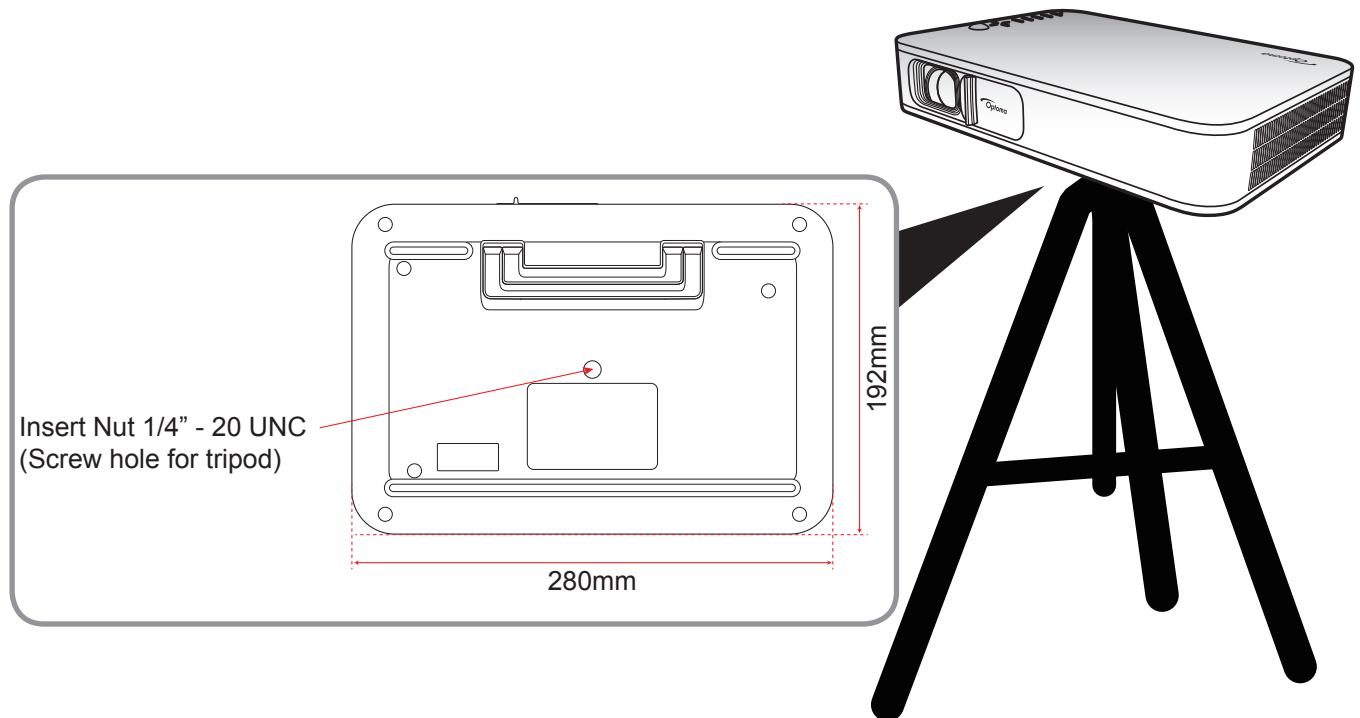

Note:

- Please note that damage resulting from incorrect installation will void the warranty.
- How to determine projector location for a given screen size, please refer to distance table on page 35.

SETUP AND INSTALLATION

Connecting sources to the projector

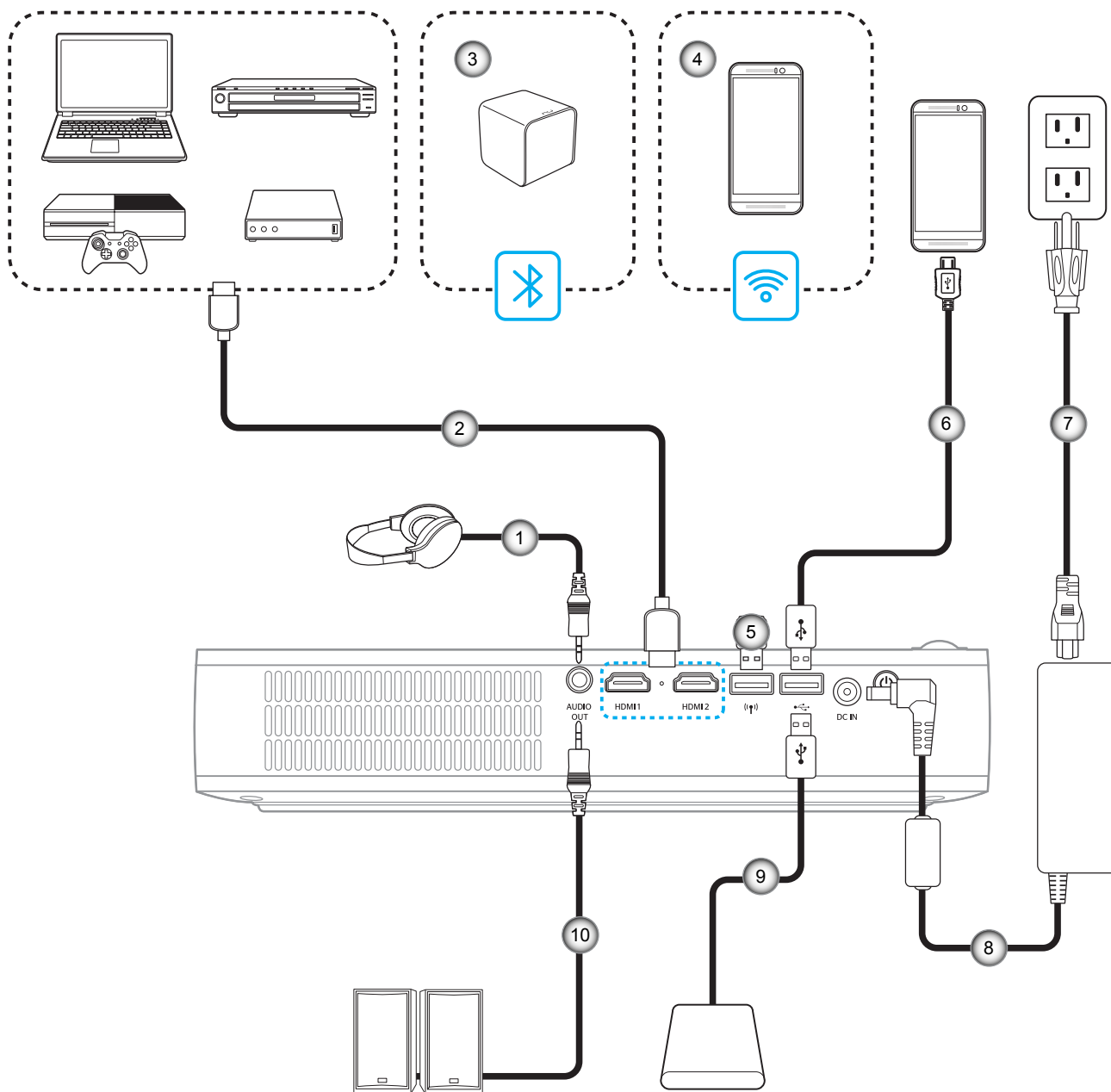

No	Item	No	Item
1.	Audio Out Cable	6.	USB Cable
2.	HDMI Cable	7.	Power Cord
3.	Bluetooth Connection	8.	Power Adapter
4.	Wireless (Wi-Fi) Connection	9.	USB Cable
5.	Wi-Fi Dongle	10.	Audio Out Cable

SETUP AND INSTALLATION

Adjusting the projector image

Image height

Open the kickstand to adjust the image height.

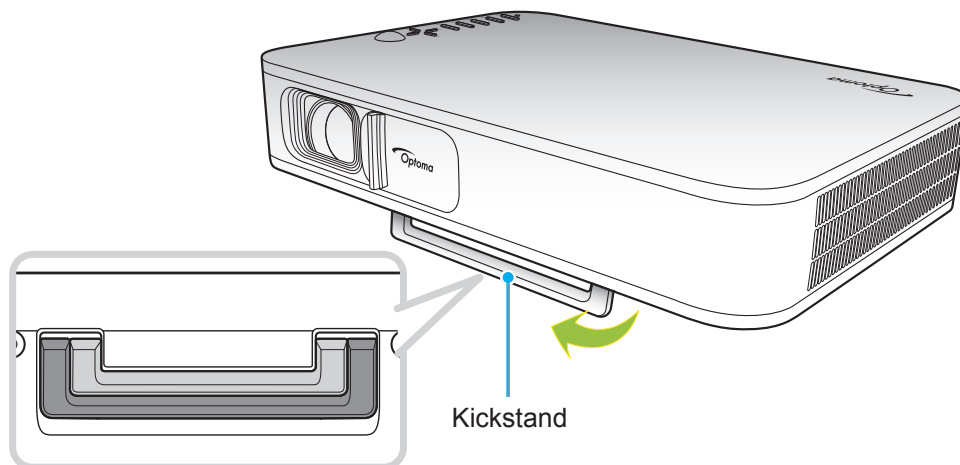

Focus

Turn the focus ring up or down until the image is clear.

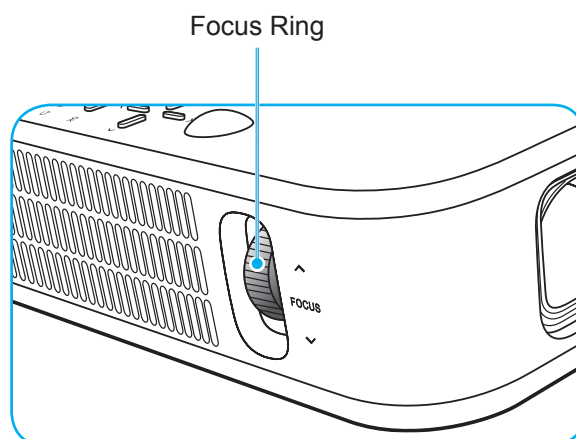

SETUP AND INSTALLATION

Remote setup

Installing / replacing the batteries

Two AAA size batteries are supplied for the remote control.

1. Remove the battery cover on the back of the remote control.
2. Insert AAA batteries in the battery compartment as illustrated.
3. Replace back cover on remote control.

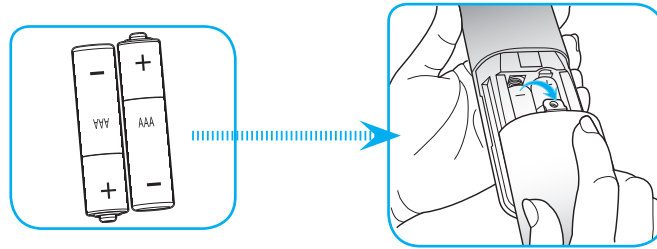

Note: Replace only with the same or equivalent type batteries.

CAUTION

Improper use of batteries can result in chemical leakage or explosion. Be sure to follow the instructions below.

- Do not mix batteries of different types. Different types of batteries have different characteristics.
- Do not mix old and new batteries. Mixing old and new batteries can shorten the life of new batteries or cause chemical leakage in old batteries.
- Remove batteries as soon as they are depleted. Chemicals that leak from batteries that come in contact with skin can cause a rash. If you find any chemical leakage, wipe thoroughly with a cloth.
- The batteries supplied with this product may have a shorter life expectancy due to storage conditions.
- If you will not be using the remote control for an extended period of time, remove the batteries.
- When you dispose of the batteries, you must obey the law in the relative area or country.

SETUP AND INSTALLATION

Effective range

Infra-Red (IR) remote control sensor is located on the top side of the projector. Make sure the operating angle of the remote control is pointed within $\pm 35^\circ$ to the IR receiver on the projector. The distance between the remote control and the sensor should not be longer than 6 meters at operating angle 45° and 14 meters at operating angle 0° .

- Make sure that there are no obstacles between the remote control and the IR sensor on the projector that might obstruct the infra-red beam.
- Make sure the IR transmitter of the remote control is not being shined by sunlight or fluorescent lamps directly.
- Please keep the remote controller away from fluorescent lamps for over 2 meters or the remote controller might become malfunction.
- If the remote control is closed to Inverter-Type fluorescent lamps, it might become ineffective from time to time.
- If the remote control and the projector are within a very short distance, the remote control might become ineffective.
- When you aim at the screen, the effective distance is less than 5 meters from the remote control to the screen and reflecting the IR beams back to the projector. However, the effective range might change according to screens.

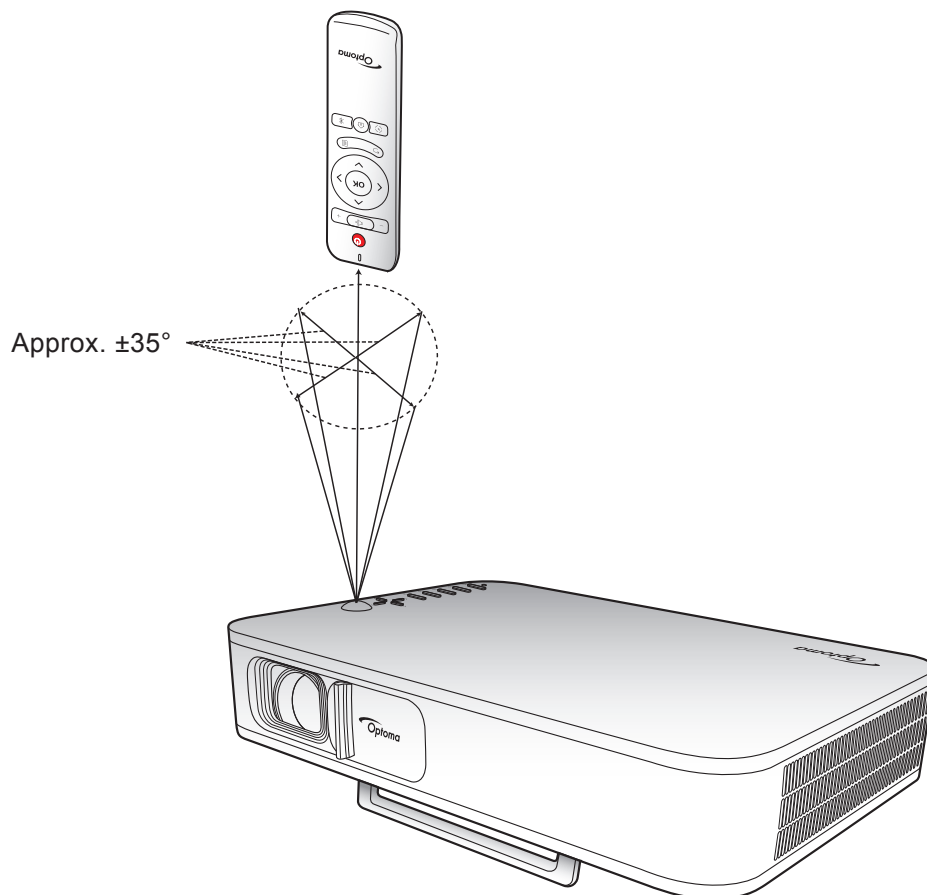

USING THE PROJECTOR

Charging the projector built-in battery

The projector is equipped with a built-in battery. Basically, you can use the projector freely without having to search for electrical outlet.

IMPORTANT! *The battery will charge only when the projector is turned off.*

To charge the battery, do the following:

1. Connect one end of the AC power cord to the power adapter. Then connect the power adapter to the DC IN connector on the projector.
2. Connect the other end of the AC power cord to the electrical outlet. When connected, the status LED will turn red. It will take approximately 2.5 to 3 hours for the battery to be fully charged (from 0% to 100%).

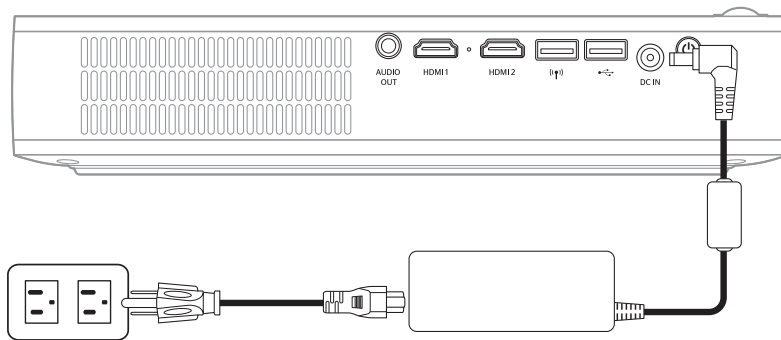

Note:

- *The status LED will turn off when the battery is fully charged.*
- *The built-in battery can last up to 1.5 hours in the Bright mode and 2.5 hours in the ECO mode.*

USING THE PROJECTOR

Using the projector as a power bank

With the built-in battery, the projector can also be a power bank for your mobile devices.

To charge your mobile device, do the following:

1. Connect one end of the USB cable to the USB connector on the projector.
2. Connect the other end of the USB cable to the USB port on your mobile device.

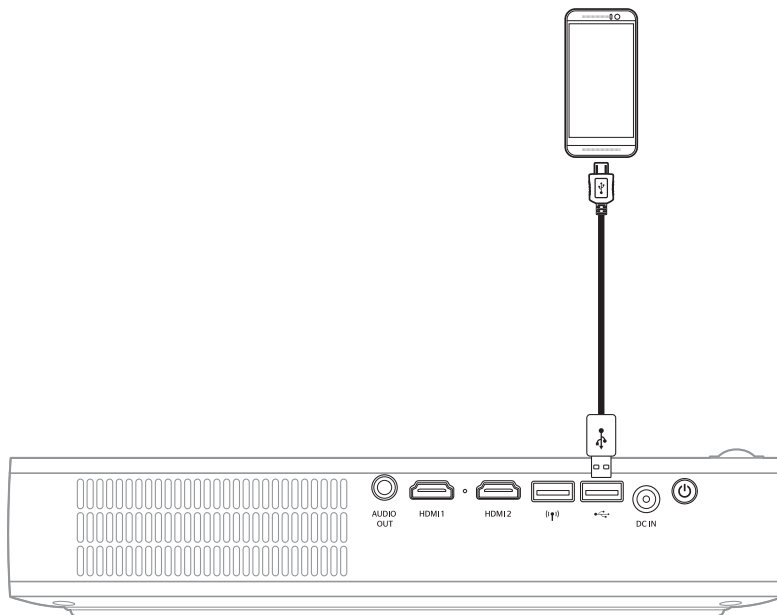

Note: If the power cord is unplugged, the USB connector will output power only when the **USB 5V (Standby)** setting is set to **On**. For details, please refer to page 33.

USING THE PROJECTOR

Powering on / off the projector

Powering on

1. Connect the signal/source cable.
2. Slide the lens cover lever to the right. The projector will automatically turn on.

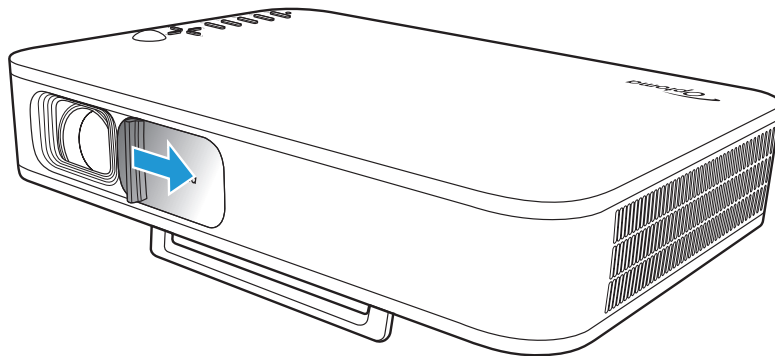

Note:

- If the lens cover is open, you can turn on the projector by pressing the **Power** button on the projector or the  button on the remote control.
- You can also use the projector when it is connected to a power supply. However, the battery will not charge when the projector is turned on.

Powering off

To turn off the projector, do one of the following:

- Slide the lens cover to the left.
- Press the **Power** button on the rear of the projector.
- Press the  button on the remote control.

When the status LED turns off, this indicates the projector has properly been turned off.



Note: It is not recommended that the projector is turned on immediately, right after a power off procedure.

USING THE PROJECTOR

Home screen overview

The Home screen is displayed every time you start the projector.





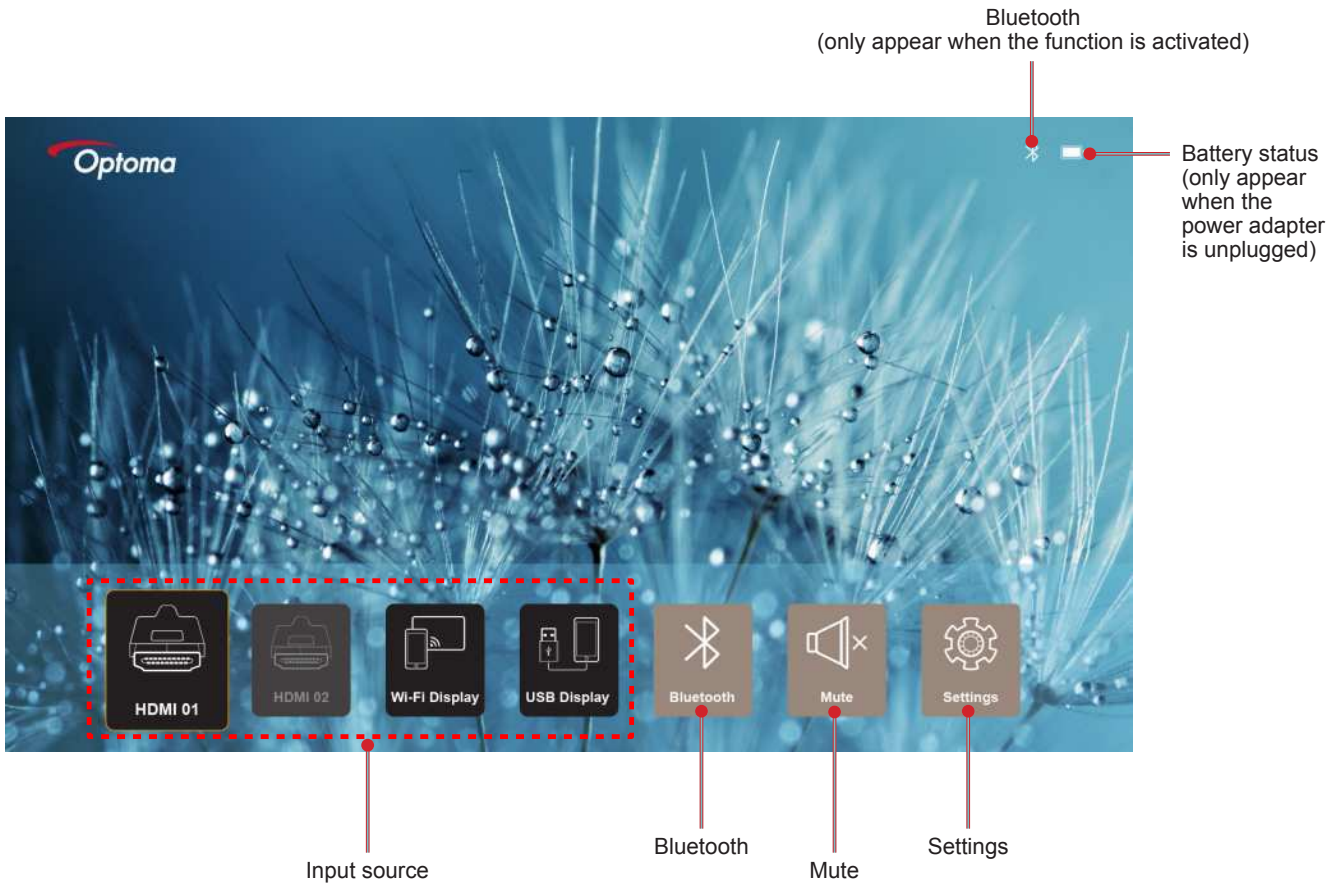













To navigate the Home screen, simply use the buttons on the remote control or the projector keypad.

You can return to the main Home screen at any time by pressing the  button on the remote control or the  button on the projector keypad regardless of what page you are on.



Home screen navigation

You can navigate the Home screen by using the remote control or the projector keypad.

Operation	Using the Remote Control	Using the Projector Keypad
Item selection	Press the  ,  ,  , or  button.	Press the  ,  ,  , or  button.
Confirm selection	Press the OK button.	Press the OK button.
Open/Hide the Settings menu	Press the  button.	Press the  button.
Open/Hide Bluetooth menu	Press the  button.	Press the  button.
Mute/Unmute sound	Press the  button.	N/A
Toggle the display mode	Press the  button.	Press the  button.
Return to the previous page	Press the  button.	Press the  button.
Return to the Home screen	Press the  button.	Press the  button.

USING THE PROJECTOR

Selecting an input source

The projector enables you to connect various input sources using cable connections, wireless network, or Bluetooth.

To change the input source:

1. Connect the signal/source cable.
2. Press the < or > button to select the desired input source and press the **OK** button to confirm the selection.

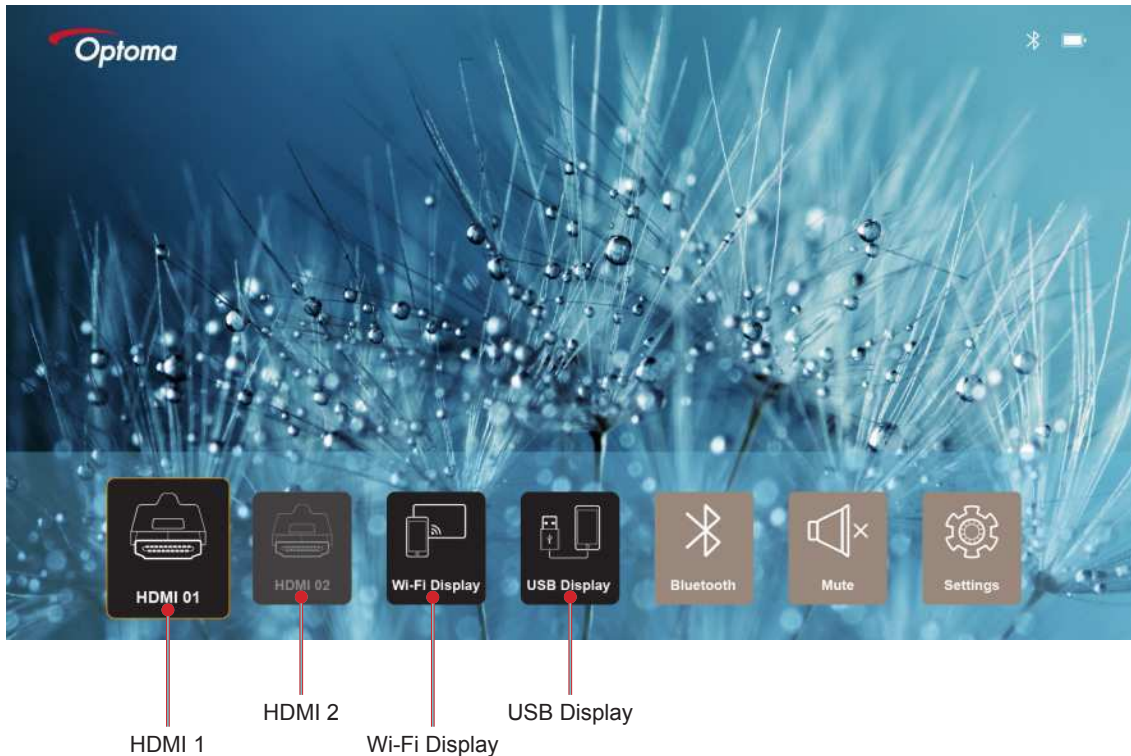

Note:

- For connecting sources to the projector, please refer to page page 12.
- For more information about the wireless connections, please refer to the “Wireless media streaming” or “Connecting to a wireless speaker” section.
- For more information about the USB display connection, please refer to the “Using the USB display function” section.

USING THE PROJECTOR

Wireless media streaming

Select **Wi-Fi Display** to project your mobile device display to the projector through Wi-Fi connection.

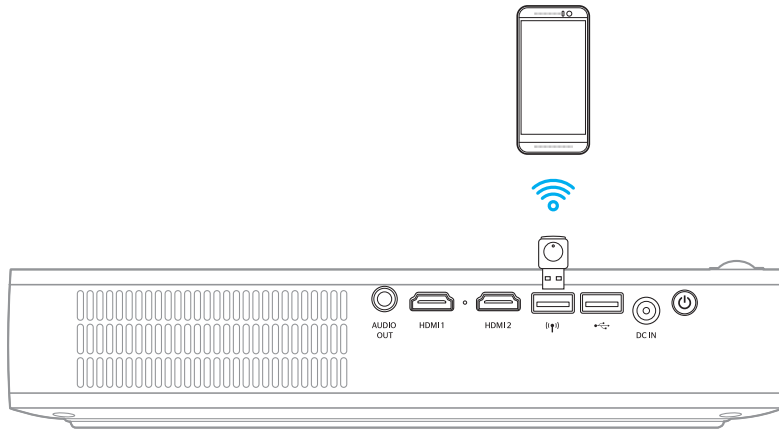

1. When using Wi-Fi Display function for the first time, download and install the HDCast Pro application into your mobile device.
Note: You can scan the QR code shown on the screen or download from the App Store or Google Play.
2. On the projector, insert the Wi-Fi dongle and select **Wi-Fi Display**.



IMPORTANT! To ensure the wireless function to work properly, the Wi-Fi dongle must be plugged into the left USB connector.

The setup guideline screen appears.

Optoma Device Name: EZCastPro_8C0E0E81
Password: 87654321

Setup process
(After setup, select the projector directly in EZCast Pro device list for casting.)

Mobile
EZCast Pro

1 Install EZCast Pro App from App Store or Google Play.

2 Connect your phone or laptop to projector in Wi-Fi settings (device password on top).

3 Launch EZCast Pro and enter "Settings" to setup a network for projector in "Network Settings".

4 Reconnect your phone or laptop to your Wi-Fi (not the "EZCast Pro_XXXX" network).

5 Select the projector directly in EZCast Pro device list for casting.

USING THE PROJECTOR

3. On your mobile device, enable the Wi-Fi function. Then connect to the projector (i.e. HDCastPro_XXXXXXX).

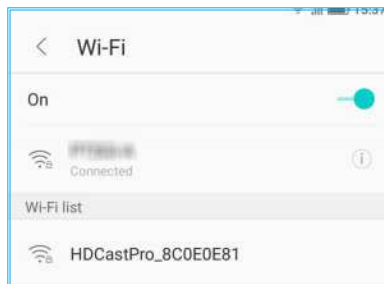

4. Enter the password to establish the connection.

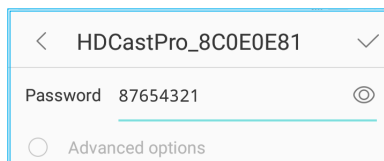

Note:

- You can obtain the 'projector name' and its password for the wireless connection setup on the setup guideline screen.

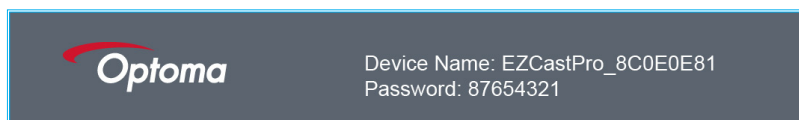

- The wireless connection process may vary depending on the device. Please refer to its respective user manual.

5. Launch "HDCast Pro" application and tap the screen to connect to the projector.

Note: When launching the application for the first time, a pop-out message will appear on the screen. Simply tap **YES** to continue.

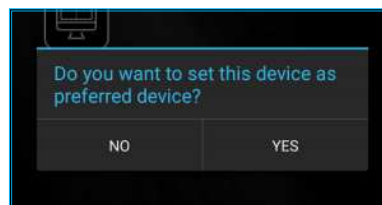

6. When the main screen appears, tap **Mirror Off** > **START NOW** to start projecting the mobile device display on the screen.

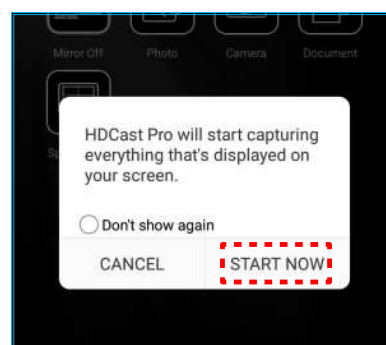

7. Select the media files you want to project.

USING THE PROJECTOR

Using the USB display function

Select **USB Display** to project your mobile device display to the projector using the USB cable connection.

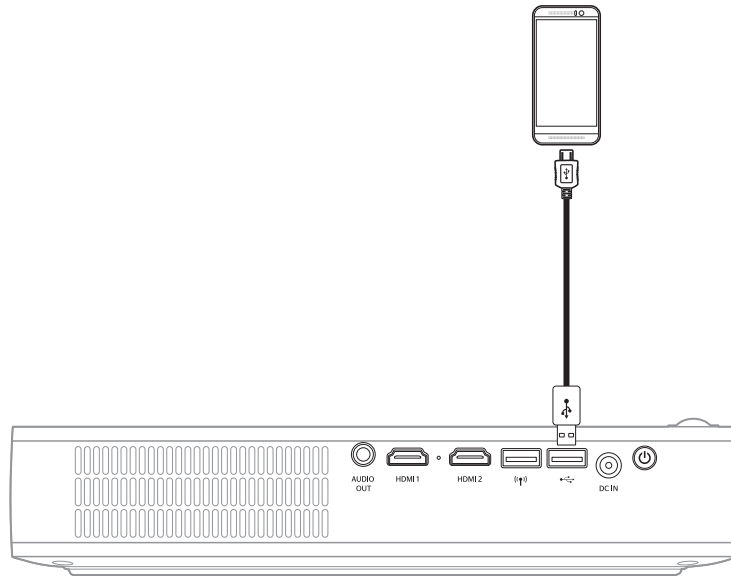

1. When using USB Display function for the first time, download and install the HDCast Pro application into your mobile device.
2. Connecting your mobile device with the projector using the USB cable.
3. On the projector, select **USB Display**.



The setup guideline screen appears.

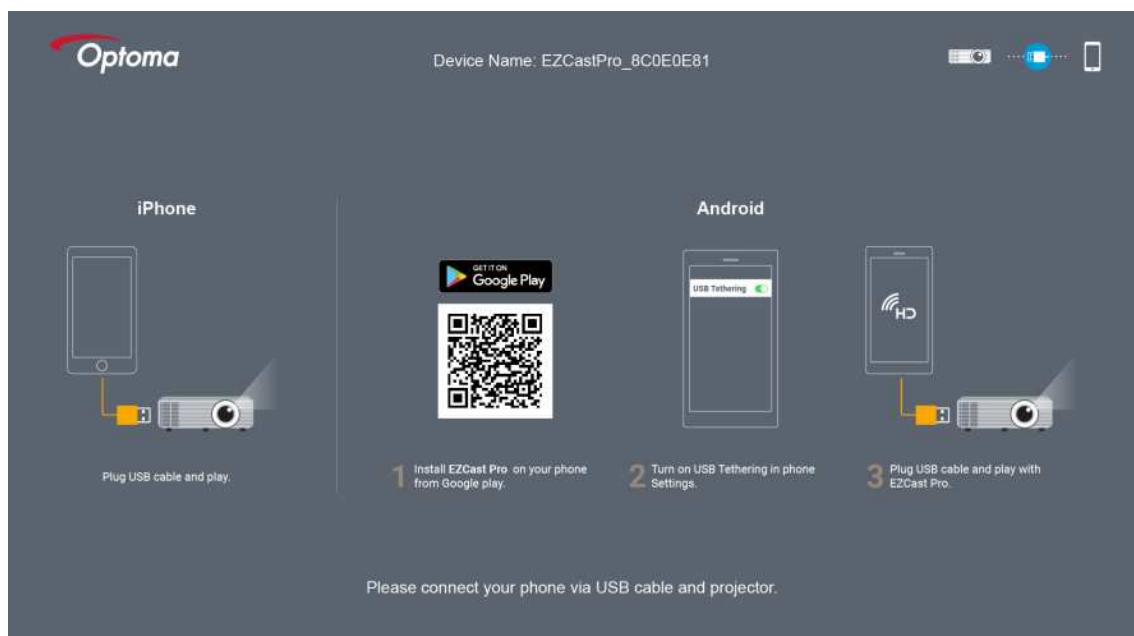

USING THE PROJECTOR

4. On your mobile device, enable the **USB Tethering** function.
For example, go to **Settings > More > Share Network > USB tethering** and set the setting to **On**.

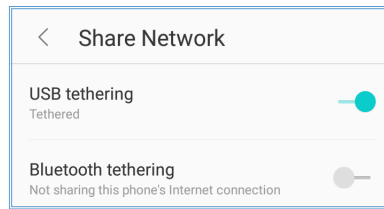

Note: *The USB Tethering configuration varies depending on the device. Please refer to its respective user manual.*

5. Launch “HDCast Pro” application and tap the screen to connect to the projector.
6. When the main screen appears, tap **Mirror Off > START NOW** to start projecting the mobile device display on the screen.

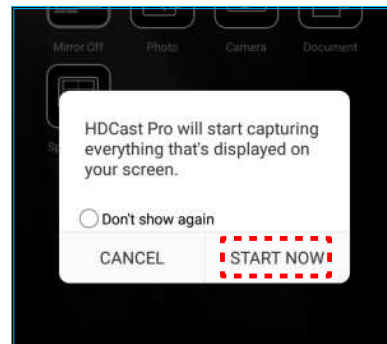

7. Select the media files you want to project.

USING THE PROJECTOR

Connecting to a wireless speaker

With the built-in Bluetooth module, you can connect the projector to a Bluetooth-enabled speaker or sound bar.

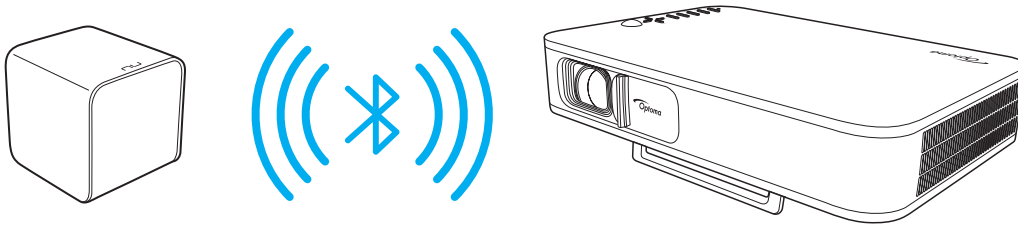

1. Open the Bluetooth menu. You can the menu by one of the following method:
 - Using the remote control: Press the button.
 - Using the projector keypad: Press the or button to select **Bluetooth** and press the **OK** button.

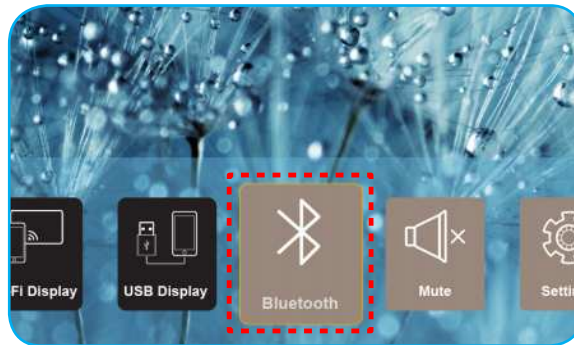

2. On your Bluetooth speaker, turn it on and enable its Bluetooth function (if necessary).
Note: For more details information on how to operate your Bluetooth speaker, please refer its documentation.
3. On the projector, set the Bluetooth setting to **On**. Then search for the Bluetooth speaker.



4. Select the “Speaker” to start pairing. Once the pairing is successful and devices are connected, you can then use the external speaker for the audio output.

Note:

- You can adjust the volume level by pressing the or button on the remote control.
- To activate the mute function, press the button on the remote control or select **Mute** from the Home screen.



- Make sure the distance between your Bluetooth speaker and the projector is less than 10 meters.

USING THE PROJECTOR

Configuring the projector settings

Select **Settings** to manage various device configurations including configuring the device settings, viewing the system information, and restore the system settings.

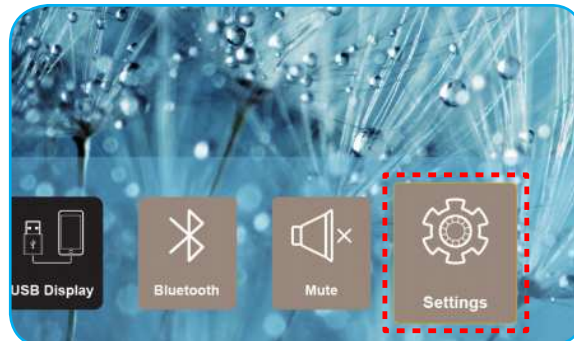

The available main menu are the following:

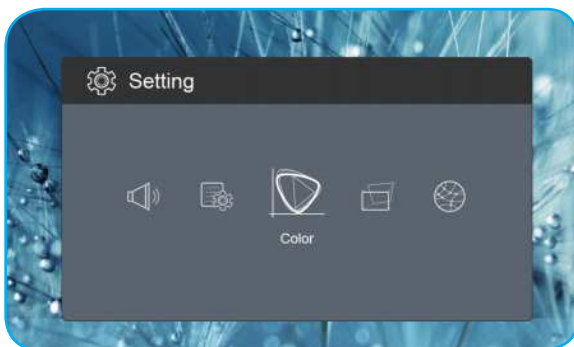

Color menu

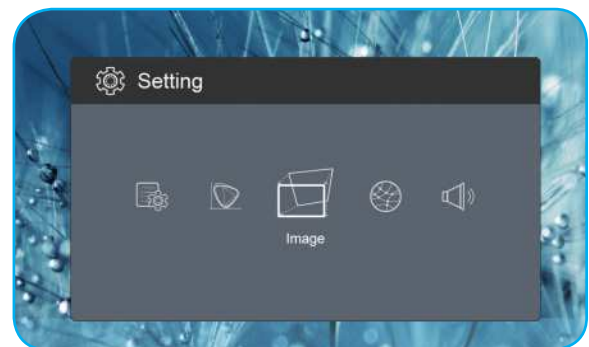
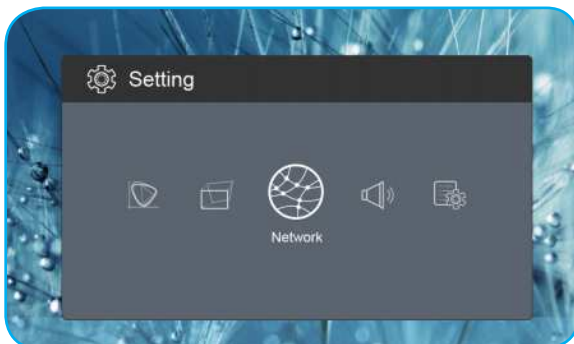
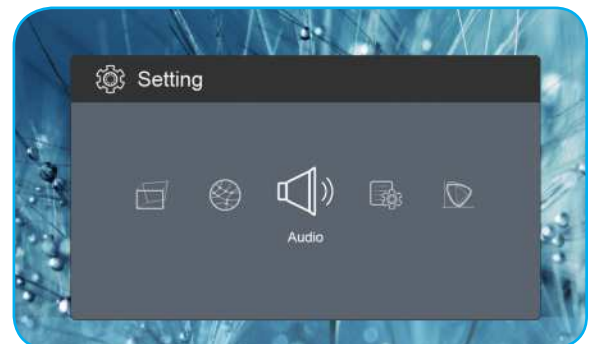

Image menu



Network menu



Audio menu

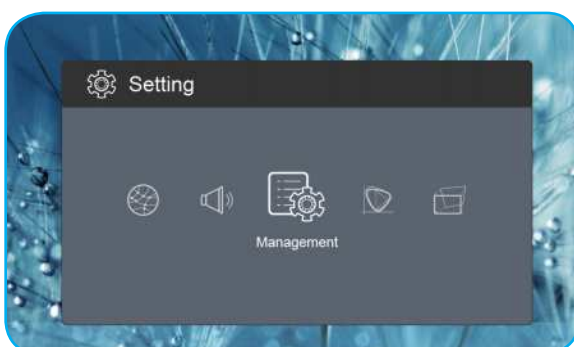

Management menu

USING THE PROJECTOR

OSD Menu tree

Level 1	Level 2	Level 3	Value
Color	Display Mode		Cinema
			Game
			Bright
			sRGB
	Brightness		0 ~ 100
	Contrast		0 ~ 100
	Saturation		0 ~ 100
	Sharpness		0 ~ 3
	Color Temperature		Standard
			Cool
			Cold
			Native
	Gamma		Standard
			Film
			Video
			Graphic
	Hue		-50 ~ +50
	Wall Color		White
			Light Yellow
			Light Blue
			Pink
		Dark Green	
Gain	R Gain	0 ~ 100	
	B Gain	0 ~ 100	
	G Gain	0 ~ 100	
	R Offset	0 ~ 100	
	G Offset	0 ~ 100	
	B Offset	0 ~ 100	
Reset			
Image	Projection Mode		Front
			Rear
	Projection Location		Desktop
			Ceiling
	Aspect Ratio		Auto
			4:3
			16:9
			L.Box
	Auto V. Keystone		On
			Off
	V. Keystone		-30 ~ +30
H. Keystone		-20 ~ +20	

USING THE PROJECTOR

Level 1	Level 2	Level 3	Value
Image	4 Corner Correction		Top Left
			Top Right
			Bottom Left
			Bottom Right
	HDMI Color Range		Auto
			Limited Range
			Full Range
	Digital Zoom		1.0
			1.2
			1.4
		1.6	
		1.8	
	Reset		
Network	Wi-Fi		On
			Off
	Wi-Fi IP		
	Reset		
Audio	Volume		0 ~ 40
	Audio Output		Auto
			Bluetooth
			Projector
	Mute		On
		Off	
	Reset		
Management	Language		English
			Čeština
			Dansk
			Deutsch
			Español
			Français
			Italiano
			Magyar
			Nederlands
			Polski
			Português
			Suomi
			Svenska
			Türkçe
			Русский
	ไทย		
	繁體中文		
	簡體中文		

USING THE PROJECTOR

Level 1	Level 2	Level 3	Value
Management	Language		日本語
			한국어
			Việt Nam
			Farsi
	Logo		Default
			Neutral
	Auto Shutdown		Off
			15
			30
			60
	ECO Mode		120
			On
	USB 5V (Standby)		Off
			On
	High Altitude		On
			Off
	AC Power On		On
			Off
	Firmware Version		
	Firmware Upgrade		OTA
			USB
	LED Lamp Hours		
	Reset		
Reset All to default			

USING THE PROJECTOR

Color menu

Display Mode

There are many factory presets optimized for various types of images.

- **Cinema:** Provides the best colors for watching movies.
- **Game:** Select this mode to increase the brightness and response time level for enjoying video games.
- **Bright:** Maximum brightness from PC input.
- **sRGB:** Standardized accurate color.

Brightness

Adjust the brightness of the image.

Contrast

The contrast controls the degree of difference between the lightest and darkest parts of the picture.

Saturation

Adjust the saturation of the image.

Sharpness

Adjust the sharpness of the image.

Color Temperature

Select a color temperature from Standard, Cool, Cold, or Native.

Gamma

Set up gamma curve type. After the initial setup and fine tuning is completed, utilize the Gamma Adjustment steps to optimize your image output.

- **Standard:** For standardized setting.
- **Film:** For home theater.
- **Video:** For video or TV source.
- **Graphics:** For PC / Photo source.

Hue

Adjust the color balance of red and green.

Wall Color

Use this function to obtain an optimized screen image according to the wall color. Select between white, light yellow, light blue, pink, and dark green.

Gain

Adjust the gain and offset for the red, green, or blue color.

Reset

Return the factory default settings the **Color** settings.

USING THE PROJECTOR

Image menu

Projection Mode

Select the preferred projection mode from Front or Rear.

Projection Location

Select the preferred projection location from Desktop or Ceiling.

Aspect Ratio

Select the aspect ratio of the displayed image.

- **Auto:** Automatically selects the appropriate display format.
- **4:3:** This format is for 4:3 input sources.
- **16:9:** This format is for 16:9 input sources, like HDTV and DVD enhanced for Wide screen TV.
- **L.Box:** This format is for non-16x9, letterbox source and for users who use external 16x9 lens to display 2.35:1 aspect ratio using full resolution.

Auto V. Keystone

Turn the automatic keystone adjustment on or off.

V. Keystone

Adjust the keystone vertically and make a squarer image. Vertical keystone is used to correct a keystone image shape in which the top and bottom are slanted to one of the sides.

H. Keystone

Adjust the keystone horizontally and make a squarer image. Horizontal keystone is used to correct a keystone image shape in which the left and right borders of the image are unequal in length.

4 Corner Correction

Allow the image to be squeezed to fit an area defined by moving each of the four corners' x and y position.

HDMI Color Range

Select an appropriate color range of the input signal.

- **Auto:** Automatically detect the color range of the input signal.
- **Limited Range:** Select this option if the color range of the input signal is from 16 to 235.
- **Full Range:** Select this option if the color range of the input signal is from 0 to 255.

Note: *This option is only available when the input source is HDMI.*

Digital Zoom

Use to reduce or magnify an image on the projection screen.

Reset

Return the factory default settings for the **Image** settings.

USING THE PROJECTOR

Network menu

Note: *This menu is only available when the Wi-Fi dongle is connected to the projector.*

Wi-Fi

Turn the Wi-Fi function on or off.

Wi-Fi IP

Display the assigned IP address.

Reset

Return the factory default settings for the **Network** settings.

Audio menu

Volume

Adjust the audio volume level.

Audio Output

Select the audio output device.

- **Auto:** Automatically select the audio output device.
- **Bluetooth:** Set the audio output device to the external Bluetooth speaker.
- **Projector:** Set the audio output device to the built-in speaker.

Mute

Use this option to temporarily turn off the sound.

- **On:** Choose the “On” to turn mute on.
- **Off:** Choose the “Off” to turn mute off.

Note: *“Mute” function affects both internal and external speaker volume.*

Reset

Return the factory default settings for the **Audio** settings.

Management menu

Language

Select the multilingual OSD menu.

Logo

Use this function to set the desired startup screen. If changes are made, they will take effect the next time the projector is powered on.

- **Default:** The default startup screen.
- **Neutral:** Logo is not displayed on startup screen.

Auto Shutdown

Sets the countdown timer interval. The countdown timer will start, when there is no signal being sent to the projector. The projector will automatically power off when the countdown has finished (in minutes).

USING THE PROJECTOR

ECO Mode

Turn the ECO mode on or off.

Note: *When enabled, it will dim the projector lamp which will lower power consumption.*

USB 5V (Standby)

Configure the USB power source when the power cord is unplugged.

- **On:** The USB port will output power only when the power cord is unplugged.
- **Off:** The USB power source is not available when the power cord is unplugged.

Note:

- *If the power cord is plugged, the USB port will output power regardless of the setting of USB 5V, and the USB port will continue to output power even when the projector is off.*
- *The USB port will continue outputting power even when no device is connected. Make sure to set the **USB 5V (Standby)** setting to **Off** before turning off the projector. Otherwise, the battery may run out of power sooner than usual.*

High Altitude

When “On” is selected, the fans will spin faster. This feature is useful in high altitude areas where the air is thin.

AC Power On

Configure the power source for the projector.

- **On:** Once the power cord is unplugged, the projector will automatically turn off. When user plugs in the power cord, the projector will turn on automatically.
- **Off:** Once the power cord is unplugged, the projector will run using the battery power.

Firmware Version

Display the current firmware version.

Firmware Upgrade

Select the method to upgrade the firmware.

LED Lamp Hours

Display the total hours of the laser diode that have been used.

Reset

Return the factory default settings for the **Management** settings.

Reset All to default

Return the factory default settings for all settings.

ADDITIONAL INFORMATION

Compatible resolutions

Digital (HDMI 1.4)

Native resolution: 1920 x 1080p @ 60Hz

Established Timing	Standard Timing	Descriptor Timing	Supported Video Mode	Detail Timing
720 x 400 @ 70Hz	1280 x 720 @ 60Hz	1920x1080@60Hz (default)	640x480p @ 60Hz 4:3	1366x768 @ 60Hz
640 x 480 @ 60Hz	1280 x 960 @ 60Hz		720 x 480p @ 60Hz 4:3	1360x768 @ 60Hz
640 x 480 @ 67Hz	1440 x 810 @ 60Hz		720 x 480p @ 60Hz 16:9	1920x540 @ 60Hz
800 x 600 @ 60Hz			1280 x 720p @ 60Hz 16:9	1280x768 @ 60Hz
1024 x 768 @ 60Hz			1920 x 1080i @ 60Hz 16:9	1920 x 1080i @ 60Hz 16:9
			720 x 480i @ 60Hz 4:3	
			720 x 480i @ 60Hz 16:9	
			1920 x 1080p @ 60Hz 16:9	
			720 x 576p @ 50Hz 4:3	
			720 x 576p @ 50Hz 16:9	
			1280 x 720p @ 50Hz 16:9	
			1920 x 1080i @ 50Hz 16:9	
			720 x 576i @ 50Hz 4:3	
			720 x 576i @ 50Hz 16:9	
			1920 x 1080p @ 50Hz 16:9	

ADDITIONAL INFORMATION

Image size and projection distance

Desired Image Size						Projection Distance	
Diagonal		Width		Height		m	feet
m	inch	m	inch	m	inch		
0.76	30	0.66	26.14	0.37	14.71	0.80	2.61
1.02	40	0.89	34.86	0.50	19.61	1.06	3.49
1.27	50	1.11	43.57	0.62	24.51	1.33	4.36
1.52	60	1.33	52.29	0.75	29.41	1.59	5.23
1.78	70	1.55	61.00	0.87	34.31	1.86	6.10
2.03	80	1.77	69.72	1.00	39.22	2.12	6.97
2.29	90	1.99	78.43	1.12	44.12	2.39	7.84
2.54	100	2.21	87.15	1.25	49.02	2.66	8.71
3.05	120	2.66	104.58	1.49	58.82	3.19	10.46
3.81	150	3.32	130.72	1.87	73.53	3.98	13.07

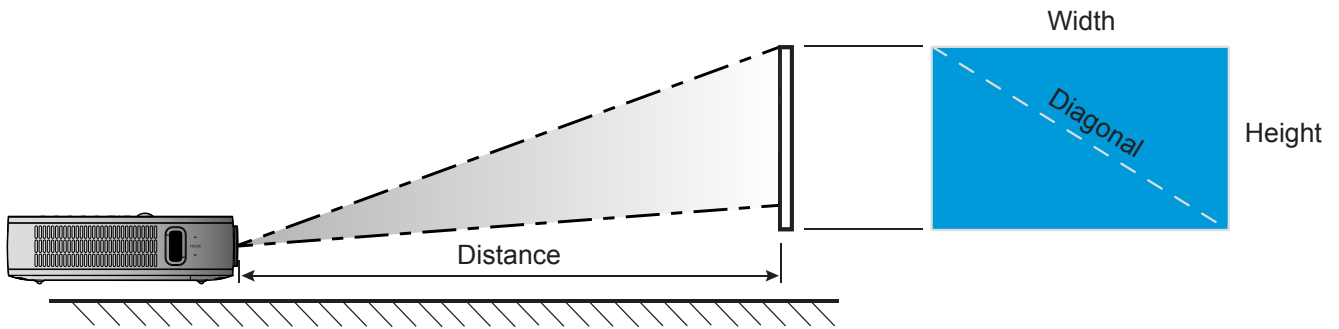

ADDITIONAL INFORMATION

Projector dimensions and ceiling mount installation

- 1/4-20 UNC thread (screw hole for tripod)

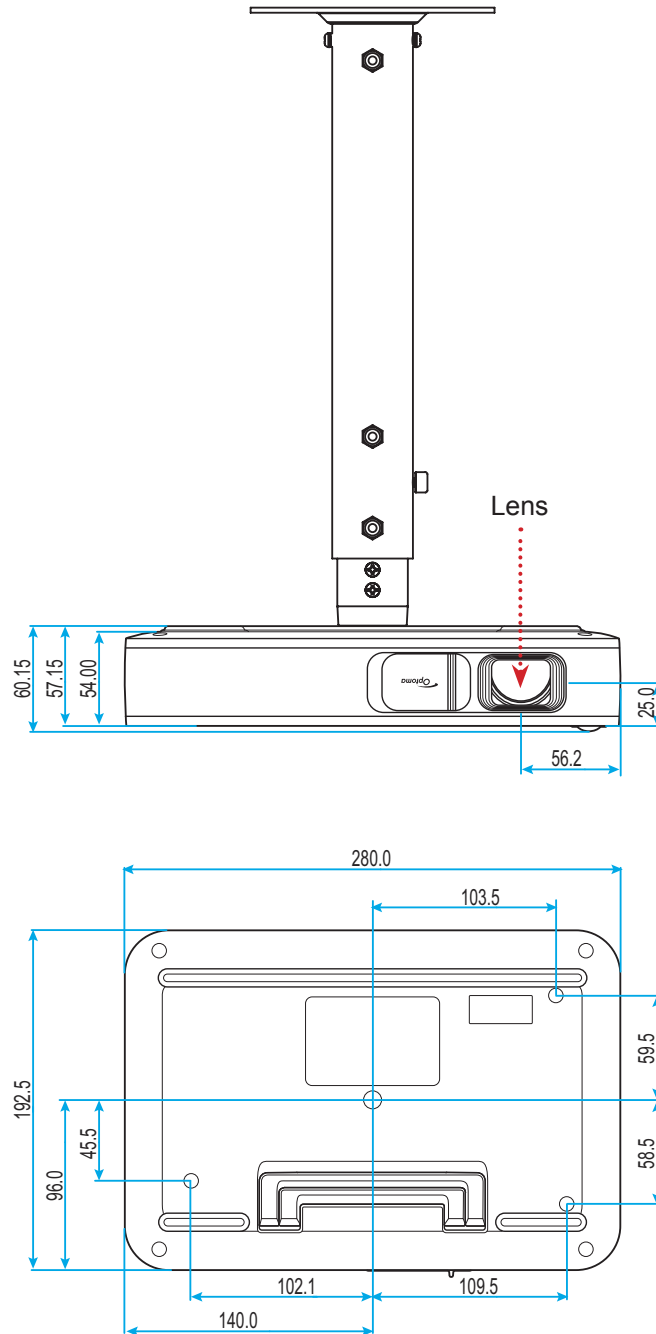

Unit: mm

Note: Please note that damage resulting from incorrect installation will void the warranty.



Warning:

- Be sure to keep at least 10 cm gap between the ceiling and the bottom of the projector.
- Avoid installing the projector near a heat source.

ADDITIONAL INFORMATION

IR remote codes

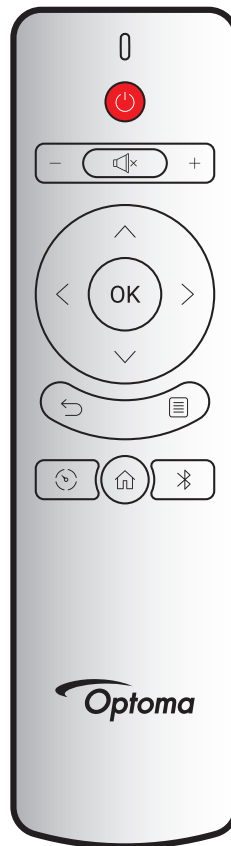

Key		Custom Code		Data Code	Description
		Byte 1	Byte 2	Byte 3	
Power on / off		3B	C4	00	Refer to the "Power On/ Off the Projector" section on page 18.
Volume +	+	3B	C4	0A	Press + to increase the volume.
Volume -	-	3B	C4	08	Press - to decrease the volume.
Mute		3B	C4	41	Press to turn off/on the projector built-in speaker.
Return		3B	C4	0E	Press to return to the previous page.
Display Mode		3B	C4	02	Press to switch the display mode.
Home		3B	C4	14	Press to return to the Home screen.
Bluetooth		3B	C4	16	Press to open the Bluetooth menu.
Settings		3B	C4	0C	Press to open the Settings menu. To exit the menu, press again.
Up		3B	C4	0D	Use <> ^ v to select items or make adjustments to your selection.
Down		3B	C4	15	
Left		3B	C4	10	
Right		3B	C4	12	
OK	OK	3B	C4	11	Confirm your item selection.

ADDITIONAL INFORMATION

Troubleshooting

If you experience a problem with your projector, please refer to the following information. If a problem persists, please contact your local reseller or service center.

Image problems

- ❓ *No image appears on-screen*
 - Ensure all the cables and power connections are correctly and securely connected as described in the "Installation" section.
 - Ensure the pins of connectors are not crooked or broken.

- ❓ *Image is out of focus*
 - Adjust the Focus Ring on the left side of the projector. Please refer to page 13.
 - Make sure the projection screen is between the required distance from the projector. Please refer to page 35.

- ❓ *The image is stretched when displaying 16:9 DVD title*
 - When you play anamorphic DVD or 16:9 DVD, the projector will show the best image in 16: 9 format on projector side.
 - If you play 4:3 format DVD title, please change the format as 4:3 in projector OSD.
 - Please setup the display format as 16:9 (wide) aspect ratio type on your DVD player.

- ❓ *Image is too small or too large*
 - Move the projector closer to or further from the screen.
 - Select "Image → Aspect Ratio" from the Settings menu and try the different settings.

- ❓ *Image has slanted sides:*
 - If possible, reposition the projector so that it is centered on the screen and below the bottom of the screen.
 - Select "Image → V. Keystone" from the Settings menu to adjust the image distortion caused by tilting the projector manually.

- ❓ *Image is reversed*
 - Select "Image → Projection Mode" from the Settings menu and adjust the projection direction.

Other problems

- ❓ *The projector stops responding to all controls*
 - If possible, turn off the projector, then unplug the power cord and wait at least 20 seconds before reconnecting power.

ADDITIONAL INFORMATION

Remote control problems

-  *If the remote control does not work*
- Check the operating angle of the remote control is pointed within $\pm 35^\circ$ to the IR receiver on the projector.
 - Make sure there are not any obstructions between the remote control and the projector. The distance between the remote control and the sensor should not be longer than 6 meters at operating angle 45° and 14 meters at operating angle 0° .
 - Make sure battery is inserted correctly and replace the batteries if they are depleted. Please refer to page 14.

ADDITIONAL INFORMATION

LED lightning messages

Message	Status LED	
	(Red)	(Green)
Battery charging	Steady light	
Power on		Steady Light
Power on, but the lens cap is not open		Flashing

Specifications

Item	Description
OE Model	Anhua F10 (.47 TRP)
CPU	Actions Micro 8290
Optical	650 ANSI lm @ FHD
HDMI input	2x 1.4b, MHL not supported
USB Port	<ul style="list-style-type: none">• 1 x USB-A for USB display and provide charging function 5V 1.5A• 1 x USB for WI-FI Dongle
Audio out	<ul style="list-style-type: none">• Mini Jack• Bluetooth Out
Keystone	2D correction (H: $\pm 20^\circ$, V: $\pm 30^\circ$)
Speaker	4W*2
Power Adapter	19V/4.7A
Battery Capacity	12000 mAh

Note: All specifications are subject to change without notice.



ADDITIONAL INFORMATION

Optoma global offices

For service or support, please contact your local office.



USA

3178 Laurelview Ct.
Fremont, CA 94538, USA
www.optomausa.com

 888-289-6786
 510-897-8601
 services@optoma.com



Canada

3178 Laurelview Ct.
Fremont, CA 94538, USA
www.optomausa.com

 888-289-6786
 510-897-8601
 services@optoma.com

Latin America

3178 Laurelview Ct.
Fremont, CA 94538, USA
www.optomausa.com

 888-289-6786
 510-897-8601
 services@optoma.com



Europe

Unit 1, Network 41, Bourne End Mills,
Hemel Hempstead, Herts,
HP1 2UJ, United Kingdom
www.optoma.eu
Service Tel : +44 (0)1923 691865

 +44 (0) 1923 691 800
 +44 (0) 1923 691 888
 service@tsc-europe.com



Benelux BV

Randstad 22-123
1316 BW Almere
The Netherlands
www.optoma.nl

 +31 (0) 36 820 0252
 +31 (0) 36 548 9052

France

Bâtiment E
81-83 avenue Edouard Vaillant
92100 Boulogne Billancourt, France

 +33 1 41 46 12 20
 +33 1 41 46 94 35
 savoptoma@optoma.fr



Spain

C/ José Hierro,36 Of. 1C
28522 Rivas VaciaMadrid,
Spain

 +34 91 499 06 06
 +34 91 670 08 32



Deutschland

Wiesenstrasse 21 W
D40549 Düsseldorf,
Germany

 +49 (0) 211 506 6670
 +49 (0) 211 506 66799
 info@optoma.de

Scandinavia



Lerpeveien 25
3040 Drammen
Norway

 +47 32 98 89 90
 +47 32 98 89 99
 info@optoma.no

PO.BOX 9515
3038 Drammen
Norway

Korea

WOOMI TECH.CO.,LTD.
4F, Minu Bldg.33-14, Kangnam-Ku,
Seoul,135-815, KOREA
korea.optoma.com

 +82+2+34430004
 +82+2+34430005



Japan

東京都足立区綾瀬3-25-18
株式会社オーエス
コンタクトセンター:0120-380-495

 info@os-worldwide.com
www.os-worldwide.com



Taiwan

12F., No.213, Sec. 3, Beixin Rd.,
Xindian Dist., New Taipei City 231,
Taiwan, R.O.C.
www.optoma.com.tw

 +886-2-8911-8600
 +886-2-8911-6550
 services@optoma.com.tw
asia.optoma.com



Hong Kong

Unit A, 27/F Dragon Centre,
79 Wing Hong Street,
Cheung Sha Wan,
Kowloon, Hong Kong

 +852-2396-8968
 +852-2370-1222
www.optoma.com.hk

China

5F, No. 1205, Kaixuan Rd.,
Changning District
Shanghai, 200052, China

 +86-21-62947376
 +86-21-62947375
www.optoma.com.cn

