



MX863UST/MW864UST
Digital Projector
User Manual



Warranty and Copyright information

Limited warranty

BenQ warrants this product against any defects in material and workmanship, under normal usage and storage.

Proof of purchase date will be required with any warranty claim. In the event this product is found to be defective within the warranty period, BenQ's only obligation and your exclusive remedy shall be replacement of any defective parts (labor included). To obtain warranty service, immediately notify the dealer from which you purchased the product of any defects.

Important: The above warranty shall be void if the customer fails to operate the product in accordance with BenQ's written instructions, especially the ambient humidity must be in-between 10% and 90%, temperature in-between 0°C and 35°C, altitude lower than 4920 feet, and avoiding to operate the projector in a dusty environment. This warranty gives you specific legal rights, and you may have other rights which vary from country to country.

For other information, please visit www.BenQ.com.

Copyright

Copyright © 2017 by BenQ Corporation. All rights reserved. No part of this publication may be reproduced, transmitted, transcribed, stored in a retrieval system or translated into any language or computer language, in any form or by any means, electronic, mechanical, magnetic, optical, chemical, manual or otherwise, without the prior written permission of BenQ Corporation.

Disclaimer

BenQ Corporation makes no representations or warranties, either expressed or implied, with respect to the contents hereof and specifically disclaims any warranties, merchantability or fitness for any particular purpose. Further, BenQ Corporation reserves the right to revise this publication and to make changes from time to time in the contents hereof without obligation to notify any person of such revision or changes.

*DLP, Digital Micromirror Device and DMD are trademarks of Texas Instruments. Others are copyrights of their respective companies or organizations.

Patents

Please go to <http://patmarking.benq.com/> for the details on BenQ projector patent coverage.

Table of Contents

Warranty and Copyright information	2
Important safety instructions	4
Introduction	7
Shipping contents	7
Projector exterior view	8
Controls and functions.....	9
Positioning your projector	12
Choosing a location	12
Obtaining a preferred projected image size.....	13
Mounting the projector	15
Adjusting the projected image.....	17
Connection	19
Operation	21
Starting up the projector	21
Using the menus	22
Securing the projector	23
Switching input signal	24
Shutting down the projector	25
Direct power off	25
Menu operation	26
PICTURE menu	28
SOURCE menu.....	30
SYSTEM SETUP: BASIC menu	31
SYSTEM SETUP: ADVANCED menu	33
INFORMATION menu	34
Maintenance	36
Care of the projector	36
Lamp information	36
Troubleshooting	42
Specifications	43
Projector specifications	43
Dimensions	44
Timing chart.....	45

Important safety instructions

Your projector is designed and tested to meet the latest standards for safety of information technology equipment. However, to ensure safe use of this product, it is important that you follow the instructions mentioned in this manual and marked on the product.

1. **Please read this manual before you operate your projector.** Save it for future reference.

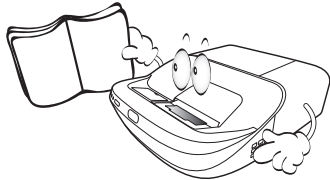

2. **Do not look straight at the projector lens during operation.** The intense light beam may damage your eyes.

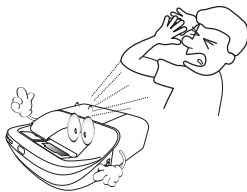

3. **Refer servicing to qualified service personnel.**

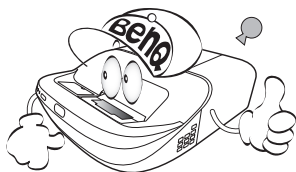

4. **Always open the lens shutter (if any) or remove the lens cap (if any) when the projector lamp is on.**

5. The lamp becomes extremely hot during operation. Allow the projector to cool for approximately 45 minutes prior to removing the lamp assembly for replacement.

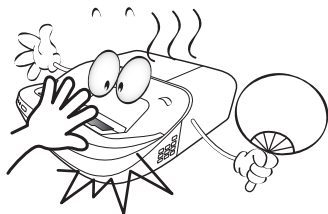

6. In some countries, the line voltage is NOT stable. This projector is designed to operate safely within a mains voltage between 100 to 240 volts AC, but could fail if power cuts or surges of ± 10 volts occur. **In areas where the mains voltage may fluctuate or cut out, it is recommended that you connect your projector through a power stabilizer, surge protector or uninterruptible power supply (UPS).**

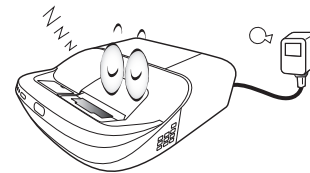

7. Do not block the projection lens with any objects when the projector is under operation as this could cause the objects to become heated and deformed or even cause a fire. To temporarily turn off the lamp, use the blank function.

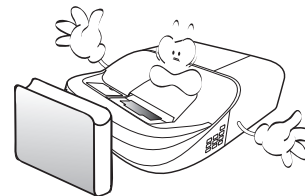

8. Do not operate lamps beyond the rated lamp life. Excessive operation of lamps beyond the rated life could cause them to break on rare occasions.

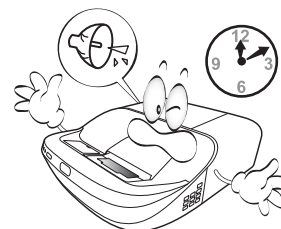

9. Never replace the lamp assembly or any electronic components unless the projector is unplugged.

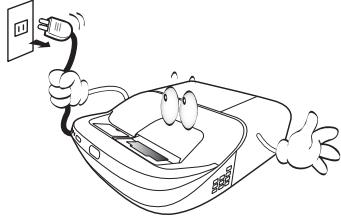

10. Do not place this product on an unstable cart, stand, or table. The product may fall, sustaining serious damage.

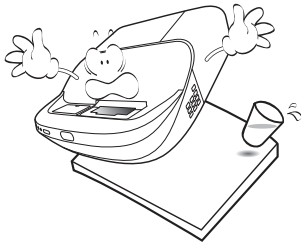

11. Do not attempt to disassemble this projector. There are dangerous high voltages inside which may cause death if you should come into contact with live parts. The only user serviceable part is the lamp which has its own removable cover.

Under no circumstances should you ever undo or remove any other covers. Refer servicing only to suitably qualified professional service personnel.

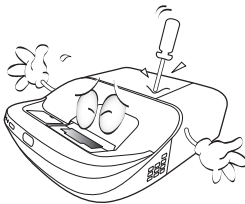

12. Do not block the ventilation holes.

- Do not place this projector on a blanket, bedding or any other soft surface.
- Do not cover this projector with a cloth or any other item.
- Do not place inflammables near the projector.

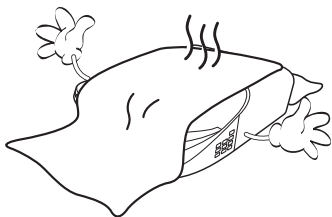

If the ventilation holes are seriously obstructed, overheating inside the projector may result in a fire.

13. Always place the projector on a level, horizontal surface during operation.

- Do not use if tilted at an angle of more than 10 degrees left to right, nor at angle of more than 15 degrees front to back. Using the projector when it is not fully horizontal may cause a malfunction of, or damage to, the lamp.

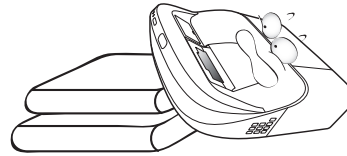

14. Do not stand the projector on end vertically. Doing so may cause the projector to fall over, causing injury or resulting in damage to the projector.

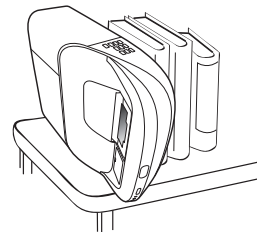

15. Do not step on the projector or place any objects upon it. Besides probable physical damage to the projector, doing so may result in accidents and possible injury.

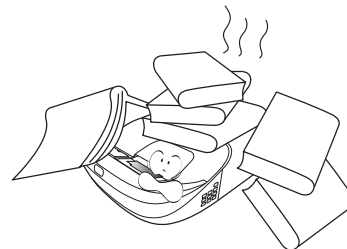

16. When the projector is under operation, you may sense some heated air and odor from its ventilation grill. It is a normal phenomenon and not a product defect.

17. Do not place liquids near or on the projector. Liquids spilled into the projector may cause it to fail. If the projector does become wet, disconnect it from the power supply's power outlet and call BenQ to have the projector serviced.

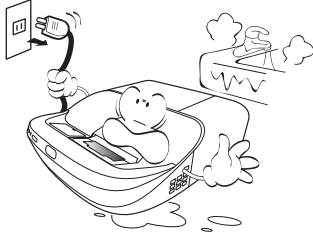

18. This product is capable of displaying inverted images for ceiling/wall mount installation.

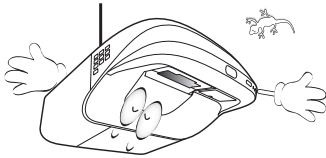

19. This apparatus must be earthed.

! Hg - Lamp contains mercury. Manage in accordance with local disposal laws. See www.lamprecycle.org.

20. Do not place this projector in any of the following environments.

- Space that is poorly ventilated or confined. Allow at least 50 cm clearance from walls and free flow of air around the projector.
- Locations where temperatures may become excessively high, such as the inside of a car with all windows rolled up.
- Locations where excessive humidity, dust, or cigarette smoke may contaminate optical components, shorten the projector's life span and darken the image.

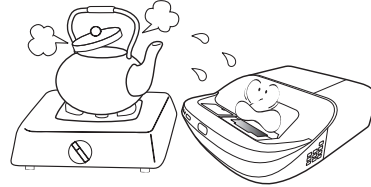

- Locations near fire alarms
- Locations with an ambient temperature above 40°C / 104°F
- Locations where the altitudes are higher than 3000 m (10000 feet).

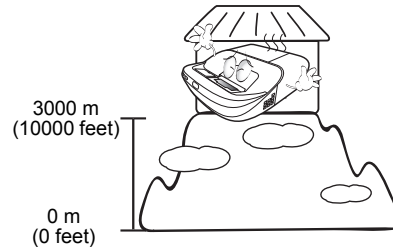



Introduction

Shipping contents

Carefully unpack and verify that you have all of the items shown below. If any of these items are missing, please contact your place of purchase.

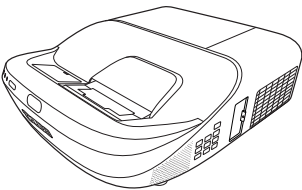
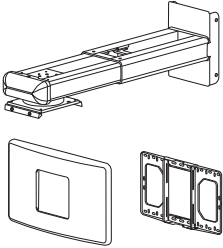
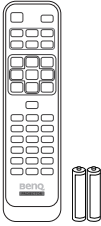
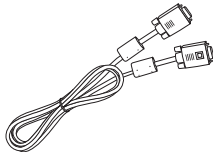
Standard accessories

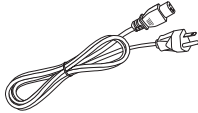
			
Projector with the projector mounting plate	Wall mount kit	Remote control with batteries	VGA cable
			
Quick start guide	Warranty card*	Power cord	



- The supplied accessories will be suitable for your region, and may differ from those illustrated.
- *The warranty card is only supplied in some specific regions. Please consult your dealer for detailed information.

Optional accessories

1. Spare lamp kit
2. 3D glasses
3. PointWrite kit

Replacing the remote control batteries

1. Press and slide off the battery cover, as illustrated.
2. Remove the old batteries (if applicable) and install two AAA batteries. Make sure that the positive and negative ends are positioned correctly, as illustrated.
3. Slide the battery cover in until it clicks into place.

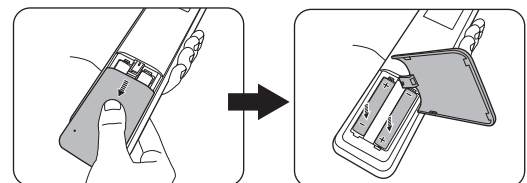

- Avoid leaving the remote control and batteries in an excessive heat or humid environment like the kitchen, bathroom, sauna, sunroom or in a closed car.
- Replace only with the same or equivalent type recommended by the battery manufacturer.
- Dispose of the used batteries according to the manufacturer's instructions and local environment regulations for your region.
- Never throw the batteries into a fire. There may be danger of an explosion.
- If the batteries are dead or if you will not be using the remote control for an extended period of time, remove the batteries to avoid damage to the remote control from possible battery leakage.

Projector exterior view

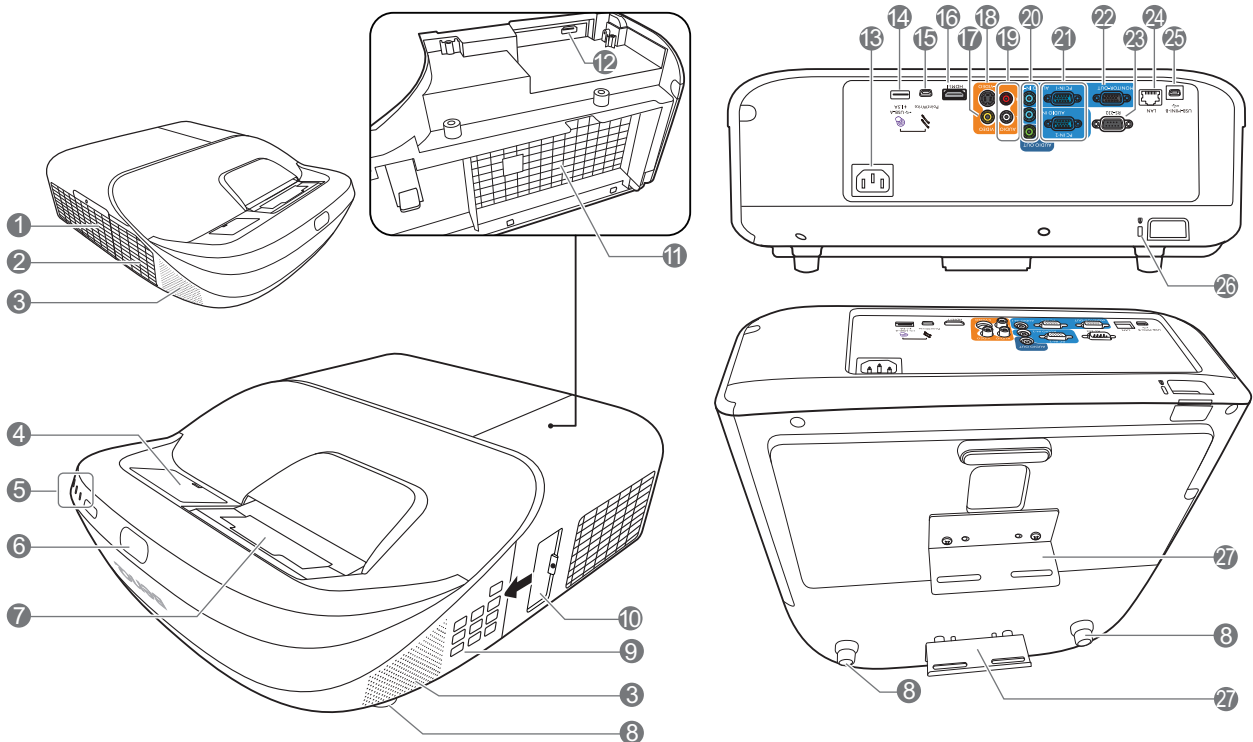

1. Lamp cover
2. Vent (heated air exhaust)
3. Speaker grill
4. PointWrite dummy cover (Optional PointWrite kit)
5. **POWER indicator light/TEMPerature warning light/LAMP indicator light** (See [Indicators on page 41.](#))
6. IR remote sensor
7. Projection lens and Mirror
8. Adjuster feet
9. External control panel (See [Controls and functions on page 9.](#))
10. Focus ring
11. Vent (cool air intake)
12. HDMI/MHL-input port (for HDMI dongle)
13. AC power jack
14. USB Type A port (Power for Touch kit)
15. PointWrite port (PointWrite kit is required)
16. HDMI input port
17. Video input jack
18. S-Video input jack
19. Audio (L/R) input jacks
20. Audio input jacks
Audio output jack
21. RGB (PC) signal input jacks
22. RGB (PC) signal output jack
23. RS-232 control port
24. RJ-45 LAN input jack
25. USB Mini-B port
26. Kensington anti-theft lock slot
27. Projector mounting plate

Controls and functions

Projector & Remote control

- All the key presses described in this document are available on the remote control or projector.
- The remote control is without laser pointer in Japan

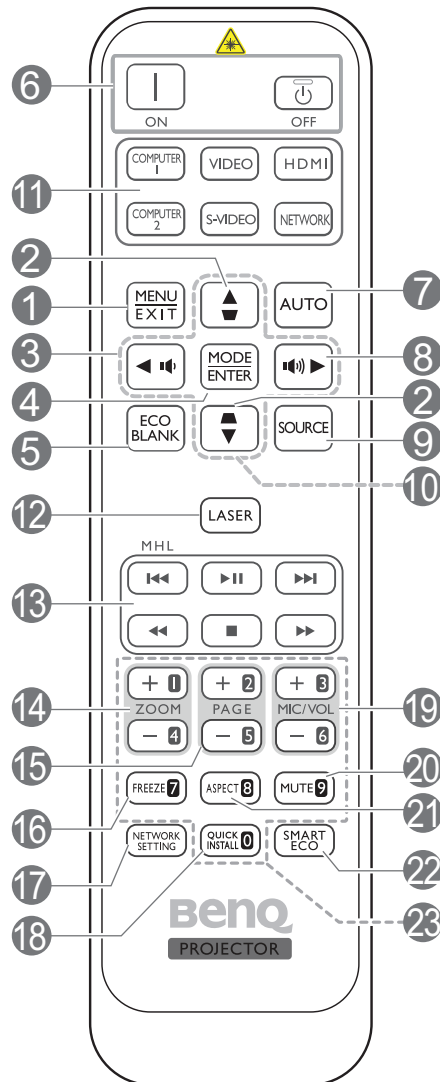
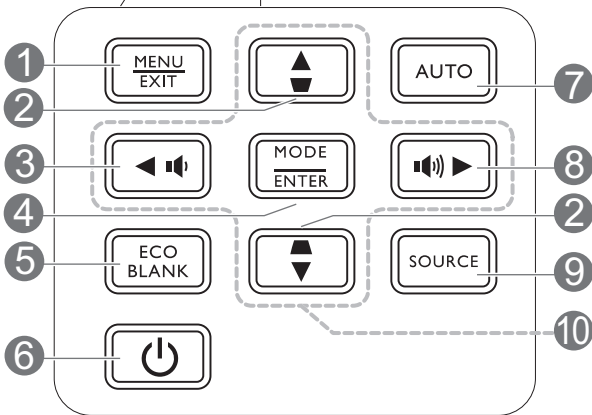
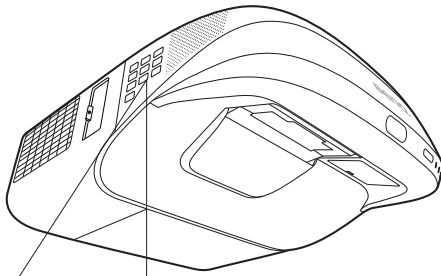

1. MENU

Turns on the On-Screen Display (OSD) menu.

EXIT

Goes back to previous OSD menu, exits and saves menu settings.

2. Keystone keys (△, ▽)

Displays the keystone correction page.

3. 🔊

Decreases the projector volume.

4. MODE

Selects an available picture setup mode.

ENTER

Confirms the selected On-Screen Display (OSD) menu item.

5. ECO BLANK

Used to hide the screen picture.



Do not block the projection lens from projecting as this could cause the blocking object to become heated and deformed or even cause a fire.

6. ⏻ POWER

Toggles the projector between standby mode and on.

⏻ ON/ ⏻ OFF

Toggles the projector between standby mode and on.

7. AUTO

Automatically determines the best picture timings for the displayed image.

8. 

Increases the projector volume.

9. **SOURCE**

Displays the source selection bar.

10. Arrow keys (▲, ▼, ◀, ▶)

When the On-Screen Display (OSD) menu is activated, these keys are used as directional arrows to select the desired menu items and to make adjustments.

11. Source selection buttons: **COMPUTER 1, COMPUTER 2, VIDEO, S-VIDEO, HDMI**

Selects an input source for display.

NETWORK

(No function.)

12. **LASER**

Emits visible laser pointer light for presentation purposes.

13. MHL control buttons

(◀◀Previous, ▶/⏸Play/Pause, ▶▶Next, ◀◀Rewind, ■ Stop, ▶▶Fast-forward)

Goes to the previous file/Plays/Pauses/Goes to the next file/Rewinds/Stops/Fast-forwards during media playback.



Only available when controlling your smart device in MHL mode.

14. **ZOOM+/ZOOM-**

Magnifies or reduces the projected picture size.

15. **PAGE+/PAGE-**

Operate your display software program (on a connected PC) which responds to page up/down commands (like Microsoft PowerPoint).

16. **FREEZE**

Freezes the projected image.

17. **NETWORK SETTING**

Displays the **QUICK INSTALL** OSD menu.

18. **QUICK INSTALL**

Quickly selects several functions to adjust the projected image and displays the test pattern.

19. **MIC/VOL+/MIC/VOL-**

(No function.)

20. **MUTE**

Toggles projector audio between on and off.

21. **ASPECT**

Selects the display aspect ratio.

22. **SMART ECO**

Displays the **Lamp Mode** menu for selecting a suitable lamp operating mode.

23. Numeric buttons

Enters numbers in network settings.

Operating the **LASER** pointer

The Laser Pointer is a presentation aid for professionals. It emits red colored light when you press it. The laser beam is visible. It is necessary to press and hold **LASER** for continuous output.

The laser pointer is not a toy. Parents should be mindful of the dangers of laser energy and keep this remote control out of the reach of children.



Do not look into the laser light window or shine the laser light beam on yourself or others. See the warning messages on the back of the remote control prior to using it.

Avoid Exposure
Laser radiation is emitted from this aperture



Controlling your smart device with the remote control

When the projector projects the content from your MHL compatible smart device, you can use the remote control to control your smart device.

To enter the MHL mode, press and hold **AUTO** for 3 seconds. The following buttons are available for controlling your smart device: **Arrow keys (▲, ▼, ◀, ▶), MENU, EXIT, ENTER, MHL control buttons.**

To leave the MHL mode, press and hold **AUTO** for 3 seconds.



When the projector is under MHL mode, the keypad on the projector should be with the same definition of the keys on the remote control.

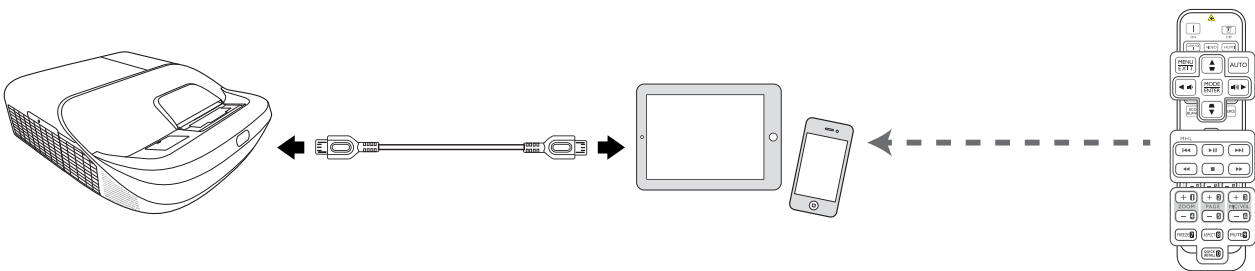

Remote control effective range

The remote control must be held at an angle within 30 degrees perpendicular to the projector's IR remote control sensor(s) to function correctly. The distance between the remote control and the sensor(s) should not exceed 8 meters (~ 26 feet).

Make sure that there are no obstacles between the remote control and the IR sensor(s) on the projector that might obstruct the infra-red beam.

- Operating the projector from the front

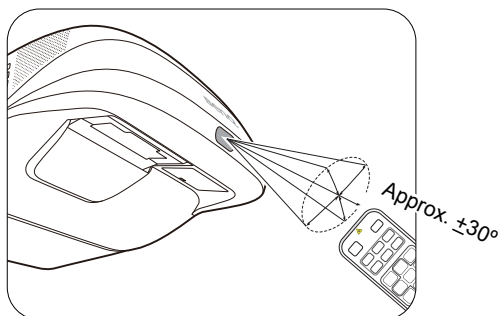

Positioning your projector

Choosing a location

Before choosing an installation location for your projector, take the following factors into consideration:

- Size and position of your screen
- Electrical outlet location
- Location and distance between the projector and the rest of your equipment

You can install your projector in the following ways.

1. Front Ceiling

Select this location with the projector suspended upside-down in front of the screen. Purchase the BenQ Projector Ceiling/Wall Mount Kit from your dealer to mount your projector on the ceiling.

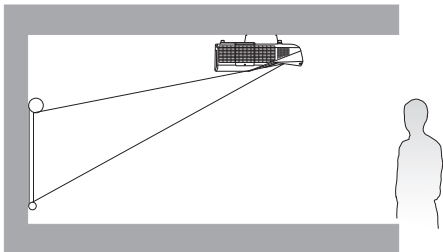

2. Rear Ceiling

Select this location with the projector suspended upside-down behind the screen. Note that a special rear projection screen and the BenQ Projector Ceiling/Wall Mount Kit are required for this installation location.

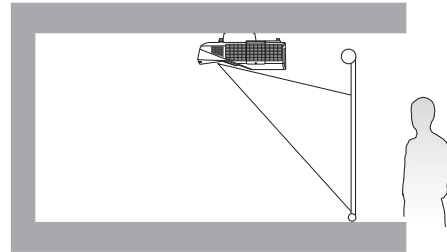

After turning on the projector, go to **SYSTEM SETUP: BASIC > Projector Installation > Projector Installation** and press ◀/▶ to select a setting.

You can also use **QUICK INSTALL** on the remote control to access this menu.

Obtaining a preferred projected image size

The distance from the projector lens to the screen, the zoom setting (if available), and the video format each factors in the projected image size.

Projection dimensions

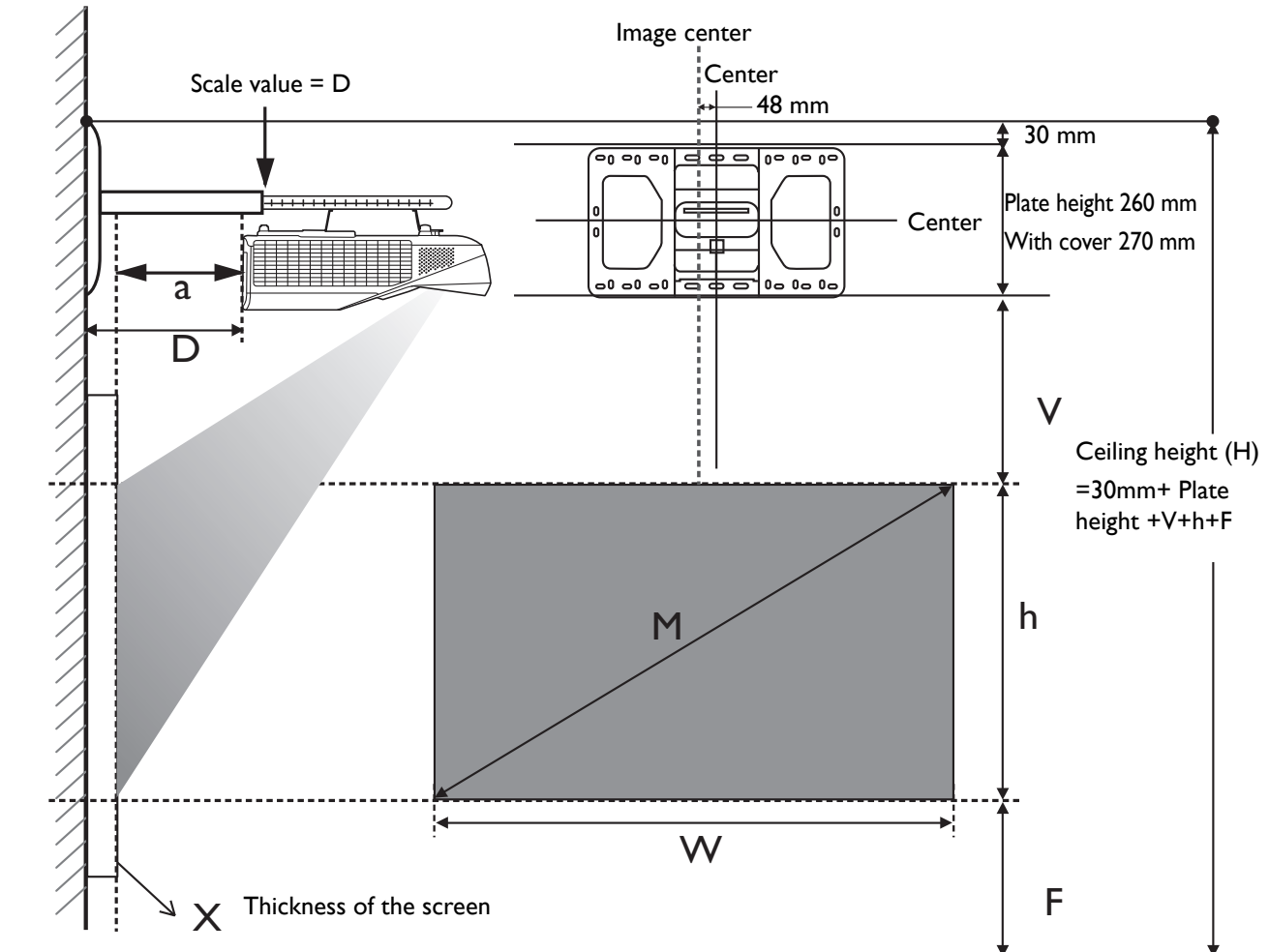

- Installation distance D is measured from the projector rear side to the wall surface, which is also indicated on the scale of the wall mount.
- Projection distance a is measured from the projector rear side to the projection surface.
- Vertical offset V is measured from the bottom edge of the wall plate to the top edge of screen.

Projection dimensions

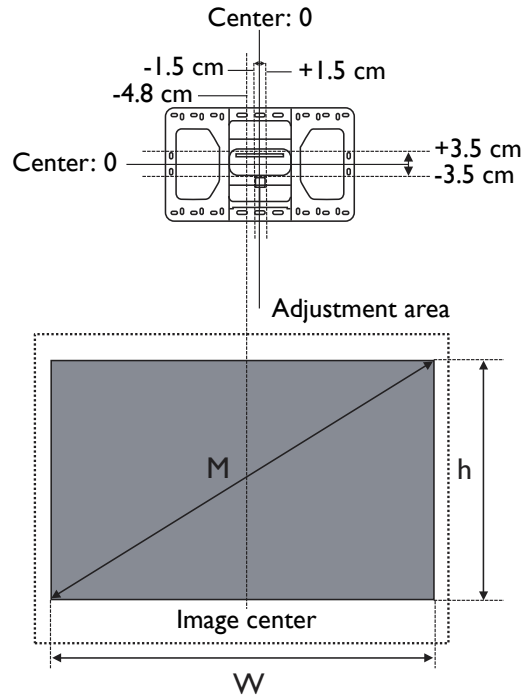

MX863UST

- The screen aspect ratio is 4:3 and the projected picture is in a 4:3 aspect ratio

Screen size			Minimum Ceiling height	Vertical offset	Installation distance (D)		
Diagonal (M)		Height (h)	H ^a	V	X ^b =0 mm (D=a)	X ^c =30 mm (D=a+30 mm)	
Inch	mm	(mm)	(mm)	(mm)	(mm)	(mm)	
73	1854	1113	1483	2401	238	88	118
78	1981	1189	1585	2490	252	118	148
83	2108	1265	1687	2580	265	147	177
88	2235	1341	1788	2670	279	177	207
93	2362	1417	1890	2760	292	207	237
98	2489	1494	1991	2849	306	236	266
100	2540	1524	2032	2885	311	248	278
103	2616	1570	2093	2939	319	266	296
108	2743	1646	2195	3029	333	296	326
110	2794	1676	2235	3065	338	308	338

- Based on an image 762 mm from the floor, if the image is lower, the min ceiling height is reduced by the measurement.
- Assume the thickness of projection screen(X) is 0 mm.
- Assume the thickness of projection screen(X) is 30 mm.



All measurements are approximate and may vary from the actual sizes.

BenQ recommends that if you intend to permanently install the projector, you should physically test the projection size and distance using the actual projector in situ before you permanently install it, so as to make allowance for this projector's optical characteristics. This will help you determine the exact mounting position so that it best suits your installation location.

MW864UST

- The screen aspect ratio is 16:10 and the projected picture is in a 16:10 aspect ratio

Screen size			Minimum Ceiling height	Vertical offset	Installation distance (D)		
Diagonal (M)		Height (h)	Width (W)	H ^a	V	X ^b =0 mm (D=a)	X ^c =30 mm (D=a+30 mm)
Inch	mm	(mm)	(mm)	(mm)	(mm)	(mm)	(mm)
86.5	2197	1164	1863	2430	216	88	118
87	2210	1171	1874	2438	217	91	121
90	2286	1212	1939	2485	223	106	136
95	2413	1279	2046	2562	233	131	161
100	2540	1346	2154	2639	243	156	186
105	2667	1414	2262	2717	253	181	211
110	2794	1481	2369	2794	263	206	236
115	2921	1548	2477	2872	273	231	261
120	3048	1615	2585	2949	284	256	286
125	3175	1683	2692	3026	294	281	311
130	3302	1750	2800	3104	304	306	336

- Based on an image 762 mm from the floor, if the image is lower, the min ceiling height is reduced by the measurement.
- Assume the thickness of projection screen(X) is 0 mm.
- Assume the thickness of projection screen(X) is 30 mm.



All measurements are approximate and may vary from the actual sizes.

BenQ recommends that if you intend to permanently install the projector, you should physically test the projection size and distance using the actual projector in situ before you permanently install it, so as to make allowance for this projector's optical characteristics. This will help you determine the exact mounting position so that it best suits your installation location.

Mounting the projector

If you intend to mount your projector, we strongly recommend that you use a proper fitting BenQ projector mounting kit and that you ensure it is securely and safely installed.

If you use a non-BenQ brand projector mounting kit, there is a safety risk that the projector may fall down due to an improper attachment through the use of the wrong gauge or length screws.

Before mounting the projector

- Purchase a BenQ projector mounting kit from the place you purchased your BenQ projector.
- BenQ recommends that you also purchase a separate Kensington lock compatible security cable and attach it securely to both the Kensington lock slot on the projector and the base of the mounting bracket. This will perform the secondary role of restraining the projector should its attachment to the mounting bracket become loose.
- Ask your dealer to install the projector for you. Installing the projector on your own may cause it to fall and result in injury.
- Take necessary procedures to prevent the projector from falling off such as during an earthquake.
- The warranty doesn't cover any product damage caused by mounting the projector with a non-BenQ brand projector mounting kit.
- Consider the surrounding temperature where the projector is ceiling/wall mounted. If a heater is used, the temperature around the ceiling may be higher than expected.

- Read the user manual for the mounting kit about the range of torque. Tightening with torque exceeding the recommended range may cause damage to the projector and subsequently falling off.
- Make sure the power outlet is at an accessible height so that you can easily shut down the projector.

Ceiling/Wall mount installation diagram

Ceiling/Wall mount screw: M4
(Max L = 25 mm; Min L = 20 mm)

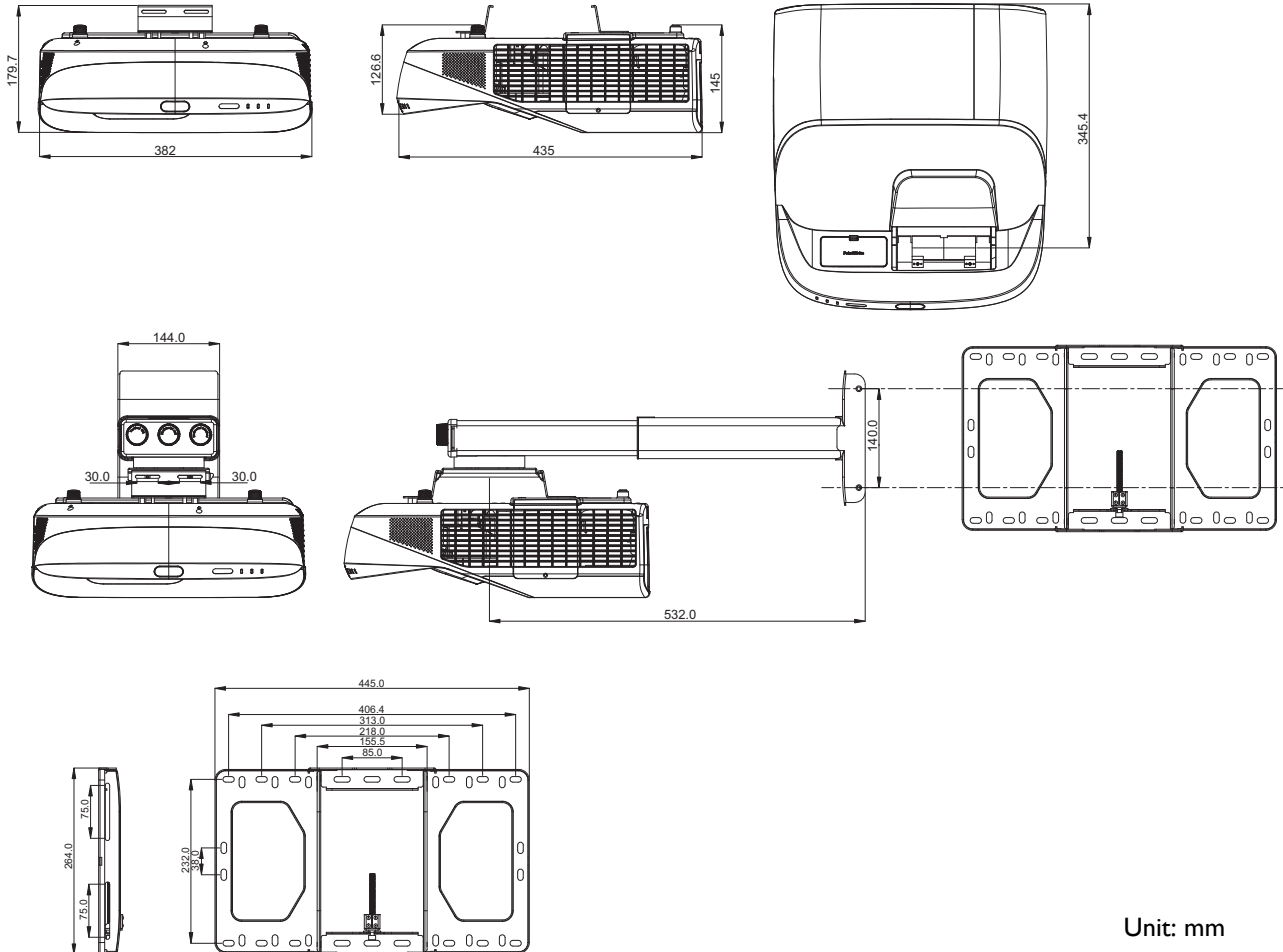

Unit: mm

Adjusting the projected image

 Do not look into the lens while the lamp is on. The strong light from the lamp may cause damage to your eyes.

Auto-adjusting the image

In some cases, you may need to optimize the picture quality. To do this, press **AUTO**. Within 3 seconds, the built-in Intelligent Auto Adjustment function will re-adjust the values of Frequency and Clock to provide the best picture quality.

The current source information will be displayed in the corner of the screen for 3 seconds.

 This function is only available when PC signal (analog RGB) is selected.

Fine-tuning the image clarity

Sharpen the image by rotating the focus ring.

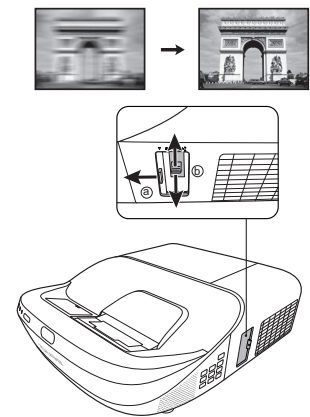

Correcting keystone

Keystoning refers to the situation where the projected image becomes a trapezoid due to angled projection.

To correct this, you will need to manually correct it following these steps.

1. Do one of the following steps to display the keystone correction page.

- Press \triangle / ∇ on the projector or remote control.
- Press **QUICK INSTALL** on the remote control. Press \blacktriangledown to highlight **2D Keystone** and press **ENTER**.
- Press **MENU** and then press \blacktriangleleft / \blacktriangleright until the **DISPLAY** menu is highlighted. Press \blacktriangledown to highlight **2D Keystone** and press **ENTER**.

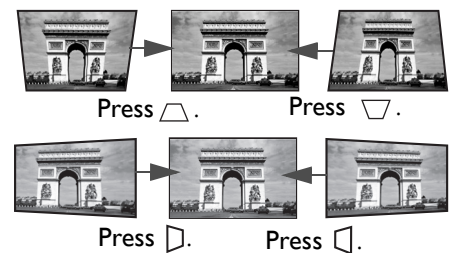

2. After the **2D Keystone** correction page displays. Press \triangle to correct keystone at the top of the image. Press ∇ to correct keystone at the bottom of the image. Press \blacktriangleright on the projector to correct keystone at the right side of the image. Press \blacktriangleleft on the projector to correct keystone at the left side of the image.

Adjusting Corner Fit

Manually adjust four corners of the image by setting the horizontal and vertical values.

1. Press **MENU** and then press ◀/▶ until the **DISPLAY** menu is highlighted.
2. Press ▼ to highlight **Corner Fit** and press **ENTER**. The **Corner Fit** correction page displays.
3. Press ▲/▼/◀/▶ to select one corner and press **ENTER**.
4. Press ▲/▼ to adjust vertical values.
5. Press ◀/▶ to adjust horizontal values.

Connection



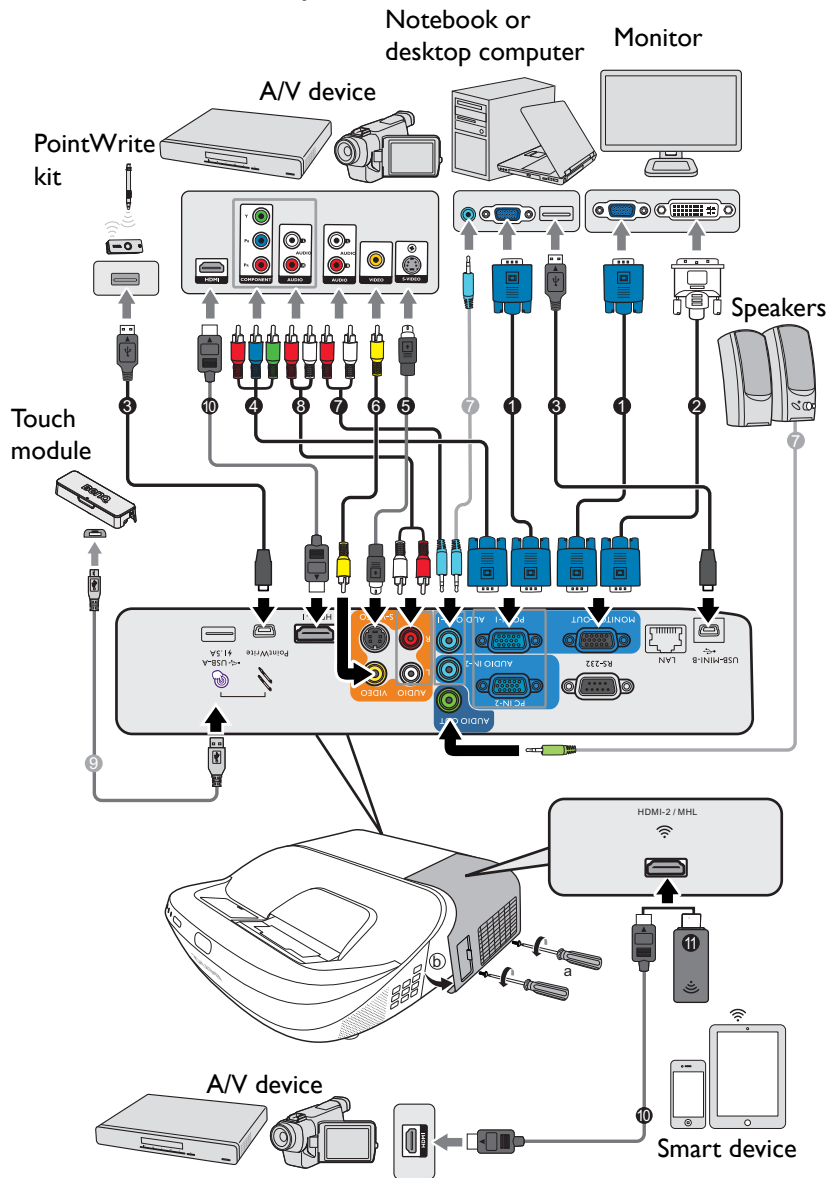

When connecting a signal source to the projector, be sure to:

1. Turn all equipment off before making any connections.
2. Use the correct signal cables for each source.
3. Ensure the cables are firmly inserted.



- In the connections above, some cables may not be included with the projector (see [Shipping contents on page 7](#)). They are commercially available from electronics stores.
- The connection illustrations are for reference only. The rear connecting jacks available on the projector vary with each projector model.
- Many notebooks do not turn on their external video ports when connected to a projector. Usually a key combo like FN + function key with a monitor symbol turns the external display on/off. Press FN and the labeled function key simultaneously. Refer to your notebook's documentation to find your notebook's key combination.
- If the selected video image is not displayed after the projector is turned on and the correct video source has been selected, check that the video source device is turned on and operating correctly. Also check that the signal cables have been connected correctly.

You need only connect the projector to a video source device using just one of the connecting methods, however each provides a different level of video quality.

Terminal		Picture quality
HDMI/MHL		Best
Component Video (through RGB input)		Better
S-Video		Good
Video		Normal

Connecting audio

The projector has built-in mono speaker(s) which are designed to provide basic audio functionality accompanying data presentations for business purposes only. They are not designed for, nor intended for stereo audio reproduction use as might be expected in home theater or home cinema applications. Any stereo audio input (if provided), is mixed into a common mono audio output through the projector speaker(s).



The built-in speaker(s) will be muted when the **AUDIO OUT** jack is connected.



- The projector is only capable of playing mixed mono audio, even if a stereo audio input is connected.
- If the selected video image is not displayed after the projector is turned on and the correct video source has been selected, check that the video source device is turned on and operating correctly. Also check that the signal cables have been connected correctly.

Operation

Starting up the projector

1. Plug the power cord. Turn on the power outlet switch (where fitted). The power indicator on the projector lights orange after power has been applied.
2. Press  on the projector or  on the remote control to start the projector. The power indicator flashes green and stays green when the projector is on.

The start up procedure takes about 30 seconds. In the later stage of start up, a startup logo is projected.

(If necessary) Rotate the focus ring to adjust the image clearness.

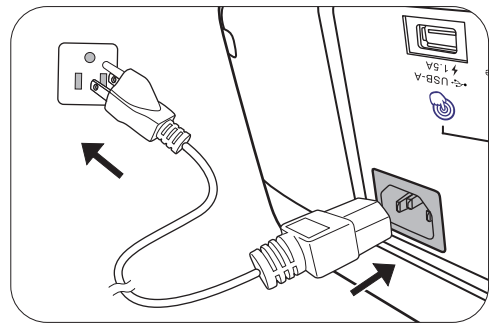

3. If the projector is activated for the first time, select your OSD language following the on-screen instructions.
4. If you are prompted for a password, press the arrow keys to enter a 6-digit password. See [Utilizing the password function on page 23](#).
5. Switch all of the connected equipment on.
6. The projector will search for input signals. The current input signal being scanned appears. If the projector does not detect a valid signal, the message “No Signal” will continue displaying until an input signal is found.

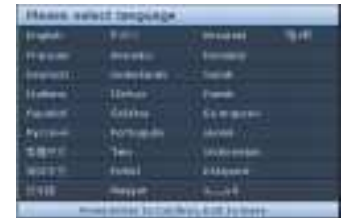

You can also press **SOURCE** to select your desired input signal. See [Switching input signal on page 24](#).



- Please use the original accessories (e.g. power cord) to avoid possible dangers such as electric shock and fire.
- If the projector is still hot from previous activity, it will run the cooling fan for approximately 90 seconds before energizing the lamp.



- The Setup Wizard screenshots are for reference only and may differ from the actual design.
- If the frequency/resolution of the input signal exceeds the projector's operating range, you will see the message “Out of Range” displayed on the background screen. Please change to an input signal which is compatible with the projector's resolution or set the input signal to a lower setting. See [Timing chart on page 45](#).
- If no signal is detected for 3 minutes, the projector automatically enters saving mode.

Using the menus

The projector is equipped with On-Screen Display (OSD) menus for making various adjustments and settings.

 The OSD screenshots below are for reference only, and may differ from the actual design.

Below is the overview of the OSD menu.

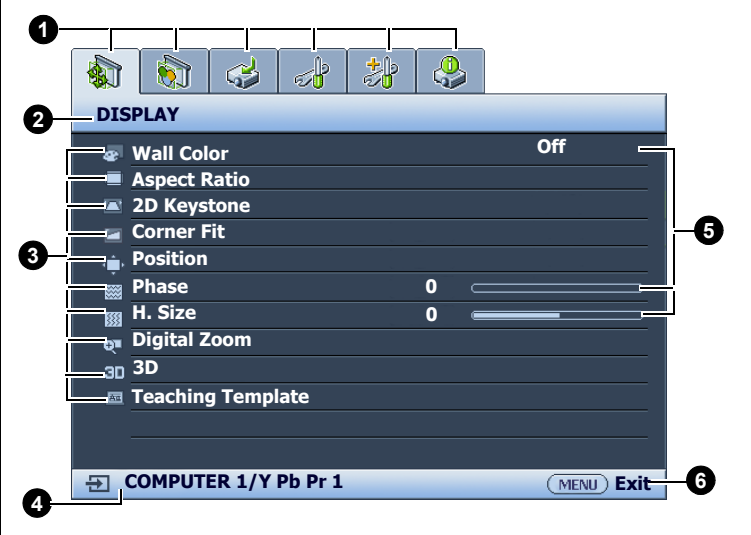
	<p>1 Main menu icon</p>	<p>4 Current input signal</p>
<p>2 Main menu</p>	<p>2 Main menu</p>	<p>5 Status</p>
<p>3 Sub-menu</p>	<p>3 Sub-menu</p>	<p>6 Press MENU to go to the previous page or to exit.</p>

To access the OSD menu, press **MENU** on the projector or remote control.

- Use the arrow keys (▲/▼/◀/▶) on the projector or remote control to move through the menu items.
- Use **ENTER** on the projector or remote control to confirm the selected menu item.

Securing the projector

Using a security cable lock

The projector has to be installed in a safe place to prevent theft. Otherwise, purchase a lock, such as the Kensington lock, to secure the projector. You can locate a Kensington lock slot on the rear side of the projector. See item 26 on [page 8](#).

A Kensington security cable lock is usually a combination of key(s) and the lock. Refer to the lock's documentation for finding out how to use it.

Utilizing the password function

Setting a password

1. Go to **SYSTEM SETUP: ADVANCED > Security Settings**. Press **ENTER**. The **Security Settings** page appears.
2. Highlight **Change Password** and press **ENTER**.
3. The four arrow keys (**▲**, **▶**, **▼**, **◀**) respectively represent 4 digits (1, 2, 3, 4). According to the password you desire to set, press the arrow keys to enter six digits for the password.
4. Confirm the new password by re-entering the new password.
Once the password is set, the OSD menu returns to the **Security Settings** page.
5. To activate the **Power On Lock** function, press **▲/▼** to highlight **Power On Lock** and press **◀/▶** to select **On**. Input the password again.



- The digits being input will display as asterisks on-screen. Make a note of your selected password and keep it in a safe place in advance or right after the password is entered so that it is available to you should you ever forget it.
- Once a password has been set and the power on lock is activated, the projector cannot be used unless the correct password is entered every time the projector is started.

If you forget the password

If you enter the wrong password, the password error message will appear, and the **Input Current Password** message follows. If you absolutely do not remember the password, you can use the password recall procedure. See [Entering the password recall procedure on page 23](#).

If you enter an incorrect password 5 times in succession, the projector will automatically shut down in a short time.

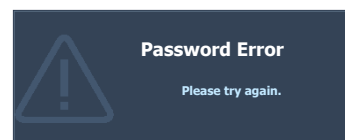

Entering the password recall procedure

1. Press and hold **AUTO** for 3 seconds. The projector will display a coded number on the screen.
2. Write down the number and turn off your projector.
3. Seek help from the local BenQ service center to decode the number. You may be required to provide proof of purchase documentation to verify that you are an authorized user of the projector.

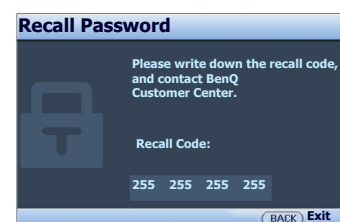

Changing the password

1. Go to **SYSTEM SETUP: ADVANCED > Security Settings > Change Password**.
2. Press **ENTER**. The message “**Input Current Password**” appears.
3. Enter the old password.
 - If the password is correct, another message “**Input New Password**” appears.
 - If the password is incorrect, the password error message will appear, and the message “**Input Current Password**” appears for your retry. You can press **EXIT** to cancel the change or try another password.
4. Enter a new password.
5. Confirm the new password by re-entering the new password.

Disabling the password function

To disable password protection, go to **SYSTEM SETUP: ADVANCED > Security Settings > Power On Lock** and press **◀/▶** to select **Off**. The message “**Input Current Password**” appears. Enter the current password.

- If the password is correct, the OSD menu returns to the **Security Settings** page. You will not have to enter the password next time turning on the projector.
- If the password is incorrect, the password error message will appear, and the message “**Input Current Password**” appears for your retry. You can press **EXIT** to cancel the change or try another password.



Though the password function is disabled, you need to keep the old password in hand should you ever need to re-activate the password function by entering the old password.

Switching input signal

The projector can be connected to multiple devices at the same time. However, it can only display one full screen at a time. When starting up, the projector automatically searches for the available signals.

Be sure the **Source > Auto Source** menu is **On** if you want the projector to automatically search for the signals.

To select the source:

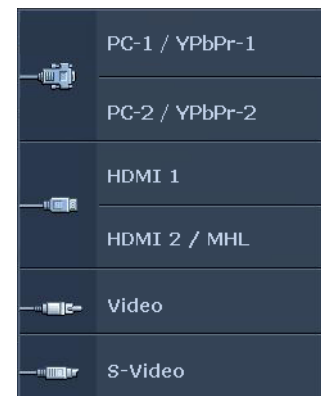

1. Press **SOURCE**. A source selection bar appears.
2. Press **▲/▼** until your desired signal is selected and press **ENTER**.

Once detected, the selected source information will appear at the corner of the screen for seconds. If there is multiple equipment connected to the projector, repeat steps 1-2 to search for another signal.



- The brightness level of the projected image will change accordingly when you switch between different input signals.
- For best display picture results, you should select and use an input signal which outputs at the projector's native resolution. Any other resolutions will be scaled by the projector depending upon the “aspect ratio” setting, which may cause some image distortion or loss of picture clarity. See [Aspect Ratio on page 26](#).

Shutting down the projector

1. Press  and a confirmation message will appear prompting you. If you don't respond in a few seconds, the message will disappear.
2. Press  a second time. The power indicator flashes orange, the projection lamp shuts down, and the fans will continue to run for approximately 90 seconds to cool down the projector.
3. Once the cooling process finishes, the power indicator becomes a steady orange and fans stop. Disconnect the power cord from the power outlet.

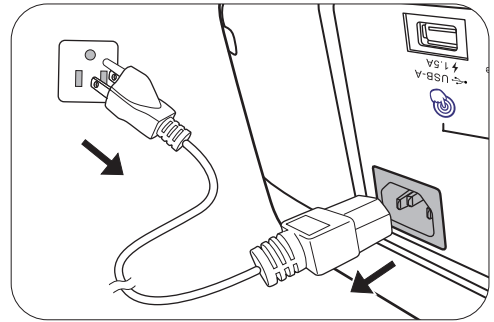

- To protect the lamp, the projector will not respond to any commands during the cooling process.
- To shorten the cooling time, you can also activate the [Quick cooling function](#). See [Quick Cooling on page 32](#).
- Avoid turning on the projector immediately after turning it off as excessive heat may shorten lamp life.
- Lamp life results will vary depending on environmental conditions and usage.

Direct power off





The AC power cord can be pulled out right after the projector is turned off. To protect the lamp, wait about 10 minutes before re-starting the projector. If you attempt to re-start the projector, the fans may run for a few minutes to cool down. In such cases, press  **POWER** again to start the projector after the fans stop and the power indicator turns orange.

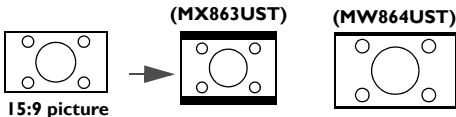

Menu operation

Please note that the on-screen display (OSD) menus vary according to the signal type selected and the projector model you are using.

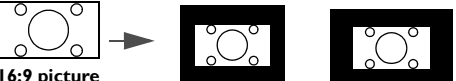
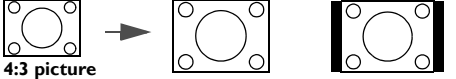
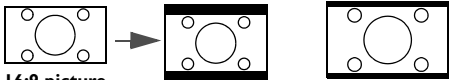
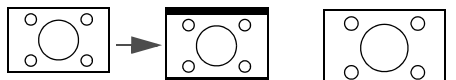
The menu items are available when the projector detects at least one valid signal. If there is no equipment connected to the projector or no signal detected, limited menu items are accessible.

DISPLAY menu

<p>Wall Color</p>	<p>Corrects the projected picture's color when the projection surface such as a painted wall which may not be white, the Wall Color feature can help correct the projected picture's colors to prevent possible color difference between the source and projected pictures. There are several precalibrated colors to choose from: Light Yellow, Pink, Light Green, Blue, and Blackboard.</p>
<p>Aspect Ratio</p>	<p>There are several options to set the image's aspect ratio depending on your input signal source.</p> <ul style="list-style-type: none"> <p>• Auto: Scales an image proportionally to fit the projector's native resolution in its horizontal or vertical width.</p>  <p>• Real: Projects an image as its original resolution and resizes it to fit within the display area. For input signals with lower resolutions, the projected image will display smaller than if resized to full screen.</p>   <p>• 4:3: Scales an image so that it is displayed in the center of the screen with a 4:3 aspect ratio.</p>  <p>• 16:9: Scales an image so that it is displayed in the center of the screen with a 16:9 aspect ratio.</p>  <p>• 16:10: Scales an image so that it is displayed in the center of the screen with a 16:10 aspect ratio.</p> 
<p>2D Keystone</p>	<p>Corrects any keystone of the image. See Correcting keystone on page 17.</p>
<p>Corner Fit</p>	<p>Adjusts four corners of the image. See Adjusting Corner Fit on page 17.</p>
<p>Position</p>	<p>Displays the position adjustment page. To move the projected image, use the directional arrow keys. This function is only available when a PC signal (analog RGB) is selected.</p>
<p>Phase</p>	<p>Adjusts the clock phase to reduce image distortion. This function is only available when a PC signal (analog RGB) is selected.</p> 

H. Size	Adjusts the horizontal width of the image. This function is only available when a PC signal (analog RGB) is selected.
Digital Zoom	<p>Magnifies or reduces the projected image.</p> <ol style="list-style-type: none"> 1. After the Zoom bar displays, press ▲ repeatedly to magnify the picture to a desired size. 2. To navigate the picture, press MODE/ENTER to switch to the panning mode and press the directional arrows (▲, ▼, ◀, ▶) on the projector or remote control to navigate the picture. 3. To reduce size of the picture, press MODE/ENTER to switch back to the zoom in/out function, and press AUTO to restore the picture to its original size. You can also press repeatedly until it is restored to the original size.  <p>The picture can only be navigated after it is magnified. You can further magnify the picture while searching for details.</p>
3D	<p>This projector features a 3D function which enables you to enjoy the 3D movies, videos, and sporting events in a more realistic way by presenting the depth of the images. You need to wear a pair of 3D glasses to view the 3D images.</p> <ul style="list-style-type: none"> • 3D Mode: The default setting is Off. If you want the projector to automatically choose an appropriate 3D format when detecting 3D contents, select Auto. If the projector cannot recognize the 3D format, press ▲/▼ to choose a 3D mode from among Top Bottom, Frame Sequential, Frame Packing and Side by Side.  <p>When 3D function is activated:</p> <ul style="list-style-type: none"> • The brightness level of the projected image will decrease. • The following settings cannot be adjusted: Picture Mode, Reference Mode. • The 2D Keystone can only be adjusted within limited degrees. • 3D Sync Invert: When you discover the inversion of the image depth, enable this function to correct the problem. • Save 3D Settings: When you have successfully displayed the 3D contents after making the appropriate adjustments, you can enable this function and choose a set of 3D settings to memorize current 3D settings. • Apply 3D Settings: After the 3D settings are saved, you can decide if you would like to apply them by choosing a set of 3D settings that you have saved. Once applied, the projector will automatically play the incoming 3D contents if it matches the 3D settings saved.  <p>Only the set(s) of 3D settings with memorized data is available.</p>
Teaching Template	<p>The projector provides several preset patterns for various teaching purposes.</p> <ol style="list-style-type: none"> 1. Press ▲/▼ to select Blackboard or Whiteboard. 2. Press ◀/▶ to choose the pattern you need from among Letter Formation, Worksheet and Coordinate Chart. 3. Press ENTER to display the pattern.

PICTURE menu

<p>Picture Mode</p>	<p>The projector is preset with several predefined picture modes so that you can choose one to suit your operating environment and input signal picture type.</p> <ul style="list-style-type: none"> • Bright: Maximizes the brightness of the projected image. This mode is suitable for environments where extra-high brightness is required, such as using the projector in well lit rooms. • Presentation: Is designed for presentations. The brightness is emphasized in this mode to match PC and notebook coloring. • sRGB: Maximizes the purity of RGB colors to provide true-to-life images regardless of brightness setting. It is most suitable for viewing photos taken with an sRGB compatible and properly calibrated camera, and for viewing PC graphic and drawing applications such as AutoCAD. • Cinema: With well-balanced color saturation and contrast with a low brightness level, this is most suitable for enjoying movies in a totally dark environment (as you would find in a commercial cinema). • 3D: Is appropriate for playing 3D images and 3D video clips. • User 1/User 2: Recalls the settings customized based on the current available picture modes. See Reference Mode on page 28.
<p>Reference Mode</p>	<p>There are 2 user-definable modes if the current available picture modes are not suitable for your need. You can use one of the picture modes (except the User 1/User 2) as a starting point and customize the settings.</p> <ol style="list-style-type: none"> 1. Go to PICTURE > Picture Mode. 2. Press ◀/▶ to select User 1 or User 2. 3. Press ▼ to highlight Reference Mode, and press ◀/▶ to select a picture mode that is closest to your need. 4. Press ▼ to select a menu item to be changed and adjust the value. The adjustments define the selected user mode.
<p>Brightness</p>	<p>The higher the value, the brighter the image. Adjust this control so the black areas of the image appear just as black and that detail in the dark areas is visible.</p>
<p>Contrast</p>	<p>The higher the value, the greater the contrast. Use this to set the peak white level after you have previously adjusted the Brightness setting to suit your selected input and viewing environment.</p>
<p>Color</p>	<p>Lower setting produces less saturated colors. If the setting is too high, colors on the image will be overpowering, which makes the image unrealistic.</p>
<p>Tint</p>	<p>The higher the value, the more greenish the picture becomes. The lower the value, the more reddish the picture becomes.</p>
<p>Sharpness</p>	<p>The higher the value, the sharper the picture becomes.</p>





<p>Brilliant Color</p>	<p>This feature utilizes a new color-processing algorithm and system level enhancements to enable higher brightness while providing truer, more vibrant colors in picture. It enables a greater than 50% brightness increase in mid-tone images, which are common in video and natural scenes, so the projector reproduces images in realistic and true colors. If you prefer images with that quality, select On.</p> <p>When Off is selected, the Color Temperature function is not available.</p>
<p>Color Temperature</p>	<p>There are several preset color temperature settings available. The available settings may vary according to the signal type selected.</p> <ul style="list-style-type: none"> • Normal: Maintains normal colorings for white. • Cool: Makes images appear bluish white. • Warm: Makes images appear reddish white.
<p>Color Temperature Fine Tuning</p>	<p>You can also set a preferred color temperature by adjusting the following options.</p> <ul style="list-style-type: none"> • R Gain/G Gain/B Gain: Adjusts the contrast levels of Red, Green, and Blue. • R Offset/G Offset/B Offset: Adjusts the brightness levels of Red, Green, and Blue.
<p>3D Color Management</p>	<p>This function provides six sets (RGBCMY) of colors to be adjusted. When you select each color, you can independently adjust its range and saturation according to your preference.</p> <ul style="list-style-type: none"> • Primary Color: Selects a color from among R (Red), G (Green), B (Blue), C (Cyan), M (Magenta), or Y (Yellow). • Hue: Increase in the range will include colors consisted of more proportions of its two adjacent colors. Please refer to the illustration for how the colors relate to each other. For example, if you select Red and set its range at 0, only pure red in the projected picture will be selected. Increasing its range will include red close to yellow and red close to magenta. • Saturation: Adjusts the values to your preference. Every adjustment made will reflect to the image immediately. For example, if you select Red and set its value at 0, only the saturation of pure red will be affected. <div data-bbox="1098 1070 1453 1406" data-label="Diagram"> </div> <p> Saturation is the amount of that color in a video picture. Lower settings produce less saturated colors; a setting of “0” removes that color from the image entirely. If the saturation is too high, that color will be overpowering and unrealistic.</p> <ul style="list-style-type: none"> • Gain: Adjusts the values to your preference. The contrast level of the primary color you select will be affected. Every adjustment made will reflect to the image immediately.
<p>Reset Picture Settings</p>	<ul style="list-style-type: none"> • Current: Returns all of the adjustments you’ve made for the selected Picture Mode to the factory preset values. • All: Returns all settings, except User 1/User 2 in the PICTURE menu to the factory preset values.

SOURCE menu



Quick Auto Search	Allows the projector to automatically search for a signal.
Color Space Conversion	<p>In the unlikely event that you connect the projector to a device (like a DVD or Blu-ray player) via the projector's HDMI input and the projected picture displays wrong colors, please change the color space to an appropriate one that fits the color space setting of the output device.</p> <ul style="list-style-type: none"> • Auto: Automatically selects a suitable color space for the incoming HDMI signal. • RGB: Sets the color space as RGB. • YUV: Sets the color space as YUV.  <p>These functions are only available when the HDMI/MHL or HDMI signal is selected.</p>
HDMI Range	<p>Selects a suitable RGB color range to correct the color accuracy.</p> <ul style="list-style-type: none"> • Auto: Automatically selects a suitable color range for the incoming HDMI signal. • Full: Utilizes the Full range RGB 0-255. • Limited: Utilizes the Limited range RGB 16-235.
HDMI Equalizer	<p>Adjusts the equalizer gain settings for an HDMI signal. The higher the setting, the stronger the gain value. If there are more than one HDMI port on the projector, select the HDMI port first before adjusting the value.</p>



SYSTEM SETUP: BASIC menu

<p>Presentation Timer</p>	<p>Presentation timer can indicate the presentation time on the screen to help you achieve better time management when giving presentations.</p> <ul style="list-style-type: none"> • Timer Period: Sets the time period. If the timer is already on, the timer will restart whenever the Timer Period is reset. • Timer Display: Allows you to decide if you want the timer to show up on the screen for one of the following time periods: <table border="1" data-bbox="379 477 1453 645"> <tr> <td>Always</td> <td>Displays the timer on screen throughout the presentation time.</td> </tr> <tr> <td>3 min/2 min/1 min</td> <td>Displays the timer on screen in the last 3/2/1 minute(s).</td> </tr> <tr> <td>Never</td> <td>Hides the timer throughout the presentation time.</td> </tr> </table> • Timer Position: Sets the timer position. • Timer Counting Direction: Sets your desired counting direction between: <table border="1" data-bbox="379 768 1453 853"> <tr> <td>Count Down</td> <td>Decreases from the preset time to 0.</td> </tr> <tr> <td>Count Up</td> <td>Increases from 0 to the preset time.</td> </tr> </table> • Sound Reminder: Allows you to decide if you want to activate sound reminder. Once enabled, a double beep sound will be heard at the last 30 seconds of counting down/up, and a triple beep sound will be produced when the timer is up. • On/Off: To activate the presentation timer, select On. 	Always	Displays the timer on screen throughout the presentation time.	3 min/2 min/1 min	Displays the timer on screen in the last 3/2/1 minute(s).	Never	Hides the timer throughout the presentation time.	Count Down	Decreases from the preset time to 0.	Count Up	Increases from 0 to the preset time.
Always	Displays the timer on screen throughout the presentation time.										
3 min/2 min/1 min	Displays the timer on screen in the last 3/2/1 minute(s).										
Never	Hides the timer throughout the presentation time.										
Count Down	Decreases from the preset time to 0.										
Count Up	Increases from 0 to the preset time.										
<p>Language</p>	<p>Sets the language for the On-Screen Display (OSD) menus.</p>										
<p>Projector Installation</p>	<p>The projector can be installed on a ceiling or behind a screen, or with one or more mirrors. See Choosing a location on page 12.</p>										
<p>Menu Settings</p>	<ul style="list-style-type: none"> • Menu Display Time: Sets the length of time the OSD will remain active after your last key press. • Menu Position: Sets the On-Screen Display (OSD) menu position. • Reminder Message: Sets the reminder messages on or off. 										

<p>Operation Settings</p>	<ul style="list-style-type: none"> • Direct Power On: Allows the projector to turn on automatically once the power is fed through the power cord. • Signal Power On: Sets whether to turn the projector directly on without pressing  POWER or  ON when the projector is in standby mode and detects a VGA signal or a HDMI signal with 5V power. • Auto Power Off: Allows the projector to turn off automatically if no input signal is detected after a set period of time to prevent unnecessary waste of lamp life. • Quick Cooling: Selecting On enables the function and projector cooling time will be shortened from a normal 90-second duration to approximately 15 seconds. • Instant Restart: Allows you to restart the projector immediately within 90 seconds after turning it off. • Blank Timer: Sets the image blank time when there is no action taken on the blank screen, once elapsed the image will return to the screen. If the preset time spans are not suitable for your need, select Disable. No matter Blank Timer is activated or not, you can press most of the keys on the projector or remote control to restore the picture. • Sleep Timer: Sets the auto-shutdown timer.
<p>Panel Key Lock</p>	<p>With the control keys on the projector and remote control locked, you can prevent your projector settings from being changed accidentally (by children, for example). When the Panel Key Lock is on, no control keys on the projector will operate except  POWER.</p> <p>To release panel key lock, press and hold  (the right key) on the projector or remote control for 3 seconds.</p>  <p>If you turn off the projector without disabling panel key lock, the projector will still be in locked status the next time it is turned on.</p>
<p>Background Color</p>	<p>Sets the background color for the projector.</p>
<p>Splash Screen</p>	<p>Allows you to select which logo screen will be displayed during projector start-up.</p>
<p>PointWrite Touch Unit</p>	<p>Disables or enables "Type A connector" 5V power output for PointWrite Touch Module.</p>

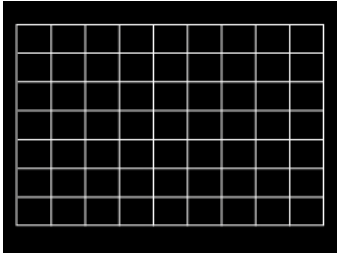
SYSTEM SETUP: ADVANCED menu

<p>High Altitude Mode</p>	<p>We recommend you use the High Altitude Mode when your environment is between 1500 m –3000 m above sea level, and ambient temperature is between 0°C–30°C.</p> <p>Operation under "High Altitude Mode" may cause a higher decibel operating noise level because of increased fan speed necessary to improve overall system cooling and performance.</p> <p>If you use this projector under other extreme conditions excluding the above, it may display auto shut-down symptoms, which is designed to protect your projector from over-heating. In cases like this, you should switch to High Altitude mode to solve these symptoms. However, this is not to state that this projector can operate under any and all harsh or extreme conditions.</p>  <p>Do not use the High Altitude Mode if your altitude is between 0 m and 1500 m and ambient temperature is between 0°C and 35°C. The projector will be over cooled, if you turn the mode on under such a condition.</p>
<p>Audio Settings</p>	<ul style="list-style-type: none"> • Mute: Temporarily turns off the sound. • Volume: Adjusts the sound level • Power On/Off Ring Tone: Turns on or off the ring tone when the projector is in startup and shutdown process.  <p>The only way to change Power On/Off Ring Tone is setting On or Off here. Setting the sound mute or changing the sound level will not affect the Power On/Off Ring Tone.</p>
<p>Lamp Settings</p>	<ul style="list-style-type: none"> • Lamp Mode: See Setting the Lamp Mode on page 37. • Reset Lamp Timer: See Resetting the lamp timer on page 40. • Lamp Timer: See Getting to know the lamp hour on page 36.
<p>Security Settings</p>	<p>See Utilizing the password function on page 23.</p>
<p>Baud Rate</p>	<p>Selects a baud rate that is identical with your computer's so that you can connect the projector using a suitable RS-232 cable and update or download the projector's firmware. This function is intended for qualified service personnel.</p>
<p>Test Pattern</p>	<p>Adjusts the image size and focus and check that the projected image is free from distortion.</p> 

<p>Closed Caption</p>	<ul style="list-style-type: none"> • Closed Caption Enable: Activates the function by selecting On when the selected input signal carries closed captions.  <p>Captions: An on-screen display of the dialogue, narration, and sound effects of TV programs and videos that are closed captioned (usually marked as "CC" in TV listings).</p> <ul style="list-style-type: none"> • Caption Version: Selects a preferred closed captioning mode. To view captions, select CC1, CC2, CC3, or CC4 (CC1 displays captions in the primary language in your area). 				
<p>Standby Settings</p>	<ul style="list-style-type: none"> • Network: Allows you to make following settings: <table border="1" data-bbox="384 568 1461 882"> <tr> <td data-bbox="384 568 703 651">Enable Network Standby Mode</td> <td data-bbox="703 568 1461 651">Allows the projector to provide the network function in standby mode.</td> </tr> <tr> <td data-bbox="384 651 703 882">Auto Disable Network Standby Mode</td> <td data-bbox="703 651 1461 882">Allows the projector to disable the network function after a set period of time after it enters standby mode. For instance, if 20 min is selected, the projector is able to provide the network function for 20 minutes after it enters standby mode. When 20 minutes is up, the projector enters normal standby mode.</td> </tr> </table> • Monitor Out: Allows the projector to output a VGA signal when it is in standby mode and the COMPUTER-I jack and the MONITOR-OUT jack are correctly connected to devices. • Audio Pass Through: The projector can play sound when it is in standby mode and the corresponding jacks are correctly connected to devices. Press ◀/▶ to choose the source that you wish to use. See Connection on page 19 for how to make the connection. 	Enable Network Standby Mode	Allows the projector to provide the network function in standby mode.	Auto Disable Network Standby Mode	Allows the projector to disable the network function after a set period of time after it enters standby mode. For instance, if 20 min is selected, the projector is able to provide the network function for 20 minutes after it enters standby mode. When 20 minutes is up, the projector enters normal standby mode.
Enable Network Standby Mode	Allows the projector to provide the network function in standby mode.				
Auto Disable Network Standby Mode	Allows the projector to disable the network function after a set period of time after it enters standby mode. For instance, if 20 min is selected, the projector is able to provide the network function for 20 minutes after it enters standby mode. When 20 minutes is up, the projector enters normal standby mode.				
<p>Network Settings</p>	<ul style="list-style-type: none"> • Wired LAN: See BenQ Network Projector Operation Guide. • AMX Device Discovery: When this function is On, the projector can be detected by AMX controller. • MAC Address: Displays the mac address for this projector. 				
<p>Reset All Settings</p>	<p>Returns all settings to the factory preset values.</p>  <p>The following settings will still remain: User 1, User 2, Color Space Conversion, Projector Installation, PointWrite Touch Unit, High Altitude Mode, Security Settings, Baud Rate, Network Settings.</p>				

INFORMATION menu

<p>Native Resolution</p>	<p>Shows the native resolution of the projector.</p>
---------------------------------	------------------------------------------------------

Current System Status	<ul style="list-style-type: none">• Source: Shows the current signal source.• Picture Mode: Shows the selected mode in the PICTURE menu.• Lamp Mode: Shows the selected mode in the Lamp Settings menu.• Resolution: Shows the native resolution of the input signal.• 3D Format: Shows the current 3D mode.• Color System: Shows input system format.• Lamp Usage Time: Shows the number of hours the lamp has been used.• Firmware Version: Shows the firmware version of your projector.
------------------------------	------------------------------------------------------------------------------------------------------------------------------------------------------------------------------------------------------------------------------------------------------------------------------------------------------------------------------------------------------------------------------------------------------------------------------------------------------------------------------------------------------------------------------------------------------------------------------------------------------------------------------------------------

Maintenance

Care of the projector

Cleaning the lens

Clean the lens whenever you notice dirt or dust on the surface. Please be sure to turn off the projector and let it cool down completely before cleaning the lens.

- Use a canister of compressed air to remove dust.
- If there is dirt or smears, use lens-cleaning paper or moisten a soft cloth with lens cleaner and gently wipe the lens surface.
- Never use any type of abrasive pad, alkaline/acid cleaner, scouring powder, or volatile solvent, such as alcohol, benzene, thinner or insecticide. Using such materials or maintaining prolonged contact with rubber or vinyl materials may result in damage to the projector surface and cabinet material.

Cleaning the projector case

Before you clean the case, turn the projector off using the proper shutdown procedure as described in [Shutting down the projector on page 25](#) and unplug the power cord.

- To remove dirt or dust, wipe the case with a soft, lint-free cloth.
- To remove stubborn dirt or stains, moisten a soft cloth with water and a neutral pH detergent. Then wipe the case.



Never use wax, alcohol, benzene, thinner or other chemical detergents. These can damage the case.

Storing the projector

If you need to store the projector for an extended time, please follow the instructions below:

- Make sure the temperature and humidity of the storage area are within the recommended range for the projector. Please refer to [Specifications on page 43](#) or consult your dealer about the range.
- Retract the adjuster feet.
- Remove the battery from the remote control.
- Pack the projector in its original packing or equivalent.

Transporting the projector

It is recommended that you ship the projector with its original packing or equivalent.

Lamp information

Getting to know the lamp hour

When the projector is in operation, the duration (in hours) of lamp usage is automatically calculated by the built-in timer. The method of calculating the equivalent lamp hour is as follows:

Lamp Usage Time = (hours used in **Normal** mode) + (hours used in **Economic** mode) + (hours used in **SmartEco** mode)

Total (equivalent) lamp hour = 2 x (hours used in **Normal** mode) + 1.5 x (hours used in **Economic** mode) + 1.0 x (hours used in **SmartEco** mode)

To obtain the lamp hour information:

1. Go to **SYSTEM SETUP: ADVANCED > Lamp Settings** and press **ENTER**. The **Lamp Settings** page appears.
2. Press **▼** to select **Lamp Timer** and press **OK**. The **Lamp Timer** information is displayed.

You can also get the lamp hour information on the **INFORMATION** menu.

Extending lamp life

• Setting the **Lamp Mode**

Go to **SYSTEM SETUP: ADVANCED > Lamp Settings > Lamp Mode** and select a suitable lamp power from among the provided modes.

Setting the projector in **Economic** or **SmartEco** mode extends lamp life.

Lamp mode	Description
Normal	Provides full lamp brightness
Economic	Lowers brightness to extend the lamp life and decreases the fan noise
SmartEco	Adjusts the lamp power automatically depending on the content brightness level

• Setting **Auto Power Off**

This function allows the projector to turn off automatically if no input signal is detected after a set period of time to prevent unnecessary waste of lamp life.

To set **Auto Power Off**, go to **SYSTEM SETUP: BASIC > Operation Settings > Auto Power Off** and press **◀/▶**.

Timing of replacing the lamp



When the **Lamp indicator** lights up red or a message appears suggesting it is time to replace the lamp, please consult your dealer or go to <http://www.BenQ.com> before installing a new lamp. An old lamp may cause a malfunction in the projector and in some instances the lamp may explode.



- The apparent brightness of the projected image will vary depending on the ambient lighting conditions, selected input signal contrast/brightness settings, and is directly proportional to projection distance.
- The lamp brightness will decline over time and may vary within the lamp manufacturers specifications. This is normal and expected behavior.
- The **LAMP indicator light** and will light up if the lamp becomes too hot. Turn the power off and let the projector cool for 45 minutes. If the Lamp or Temp indicator still lights up after turning the power back on, please contact your dealer. See [Indicators on page 41](#).

The following Lamp warning displays will remind you to change the lamp.

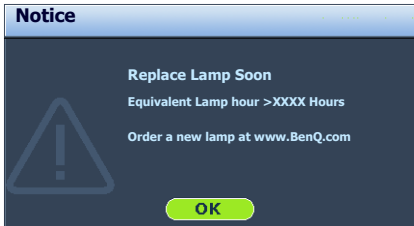
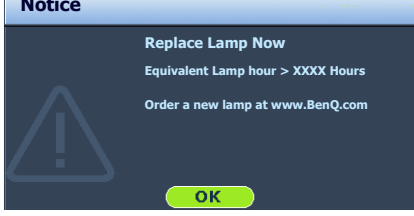
	<p>Install a new lamp for optimal performance. If the projector is normally run with Economic selected (See Getting to know the lamp hour on page 36), you may continue to operate the projector until the next hour lamp warning appears. Press OK to dismiss the message.</p>
-------------------------------------------------------------------------------------	---------------------------------------------------------------------------------------------------------------------------------------------------------------------------------------------------------------------------------------------------------------------------------------------------------------

	<p>It is strongly recommended that you replace the lamp at this age. The lamp is a consumable item. The lamp brightness diminishes with use. This is normal lamp behavior. You can replace the lamp whenever you notice that the brightness level has significantly diminished. Press OK to dismiss the message.</p>
 	<p>The lamp MUST be replaced before the projector will operate normally. Press OK to dismiss the message.</p>



"XXXX" shown in the above messages are numbers that vary depending on different models.

Replacing the lamp



- To reduce the risk of electrical shock, always turn the projector off and disconnect the power cord before changing the lamp.
 - To reduce the risk of severe burns, allow the projector to cool for at least 45 minutes before replacing the lamp.
 - To reduce the risk of injuries to fingers and damage to internal components, use caution when removing lamp glass that has shattered into sharp pieces.
 - To reduce the risk of injuries to fingers and/or compromising image quality by touching the lens, do not touch the empty lamp compartment when the lamp is removed.
 - This lamp contains mercury. Consult your local hazardous waste regulations to dispose of this lamp in a proper manner.
 - To assure optimal performance from the projector, it is recommended that you purchase a qualified projector lamp for lamp replacement.
 - If lamp replacement is performed while the projector is suspended upside-down from the ceiling, make sure that no one is underneath the lamp socket to avoid any possible injury or damage to the human eyes caused by fractured lamp.
 - Ensure good ventilation when handling broken lamps. We recommend that you use respirators, safety glasses, goggles or face shield and wear protective clothing such as gloves.
1. Turn the power off and disconnect the projector from the power outlet. If the lamp is hot, avoid burns by waiting for approximately 45 minutes until the lamp has cooled.
 2. Loosen the screw that secures the lamp cover on the side of the projector until the lamp cover loosens.

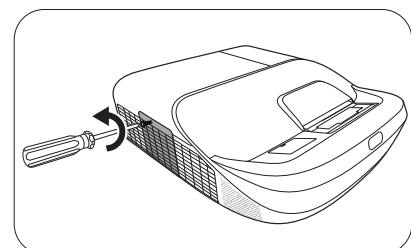

3. Remove the lamp cover from the projector.



- Do not turn the power on with the lamp cover open.
- Do not insert your fingers between the lamp and the projector. The sharp edges inside the projector may cause injuries

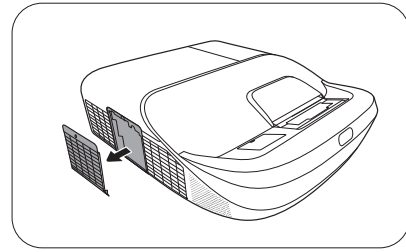

4. Loosen the screw(s) that secure the inner lamp.

5. Lift the handle so that it stands up.

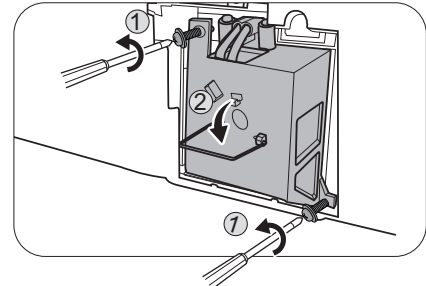

6. Use the handle to slowly pull the lamp out of the projector.



- Pulling it too quickly may cause the lamp to break and scatter broken glass in the projector.
- Do not place the lamp in locations where water might splash on it, children can reach it, or near flammable materials.
- Do not insert your hands into the projector after the lamp is removed. The sharp edges inside the projector may cause injuries. If you touch the optical components inside, it could cause color unevenness and distortion of the projected images.

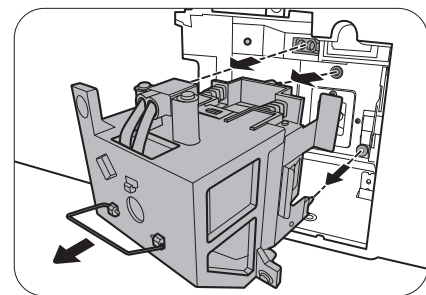

7. As shown in the figure, insert the new lamp. Align the lamp connector and 2 sharp points with the projector and push the lamp a bit into the locked position.

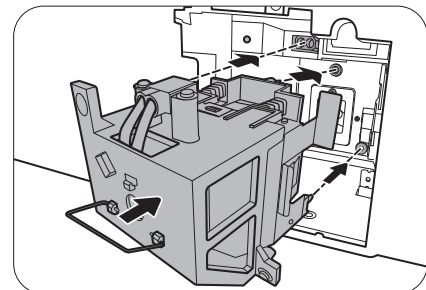

8. Tighten the screw(s) that secures the lamp.

9. Ensure the handle is fully laid flat and locked in place.



- Loose screw may cause a bad connection, which could result in malfunction.
- Do not over tighten the screw.

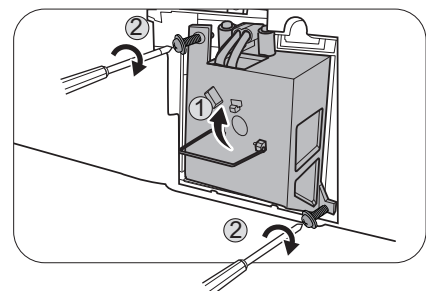

10. Replace the lamp cover on the projector.

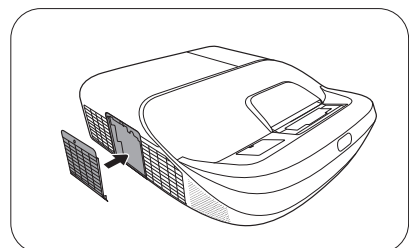

11. Tighten the screw that secures the lamp cover.



- Loose screw may cause a bad connection, which could result in malfunction.
- Do not over tighten the screw.

12. .Connect the power and restart the projector.

Resetting the lamp timer

13. After the startup logo, open the On-Screen Display







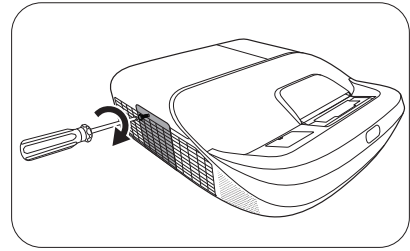















































(OSD) menu. Go to **SYSTEM SETUP: ADVANCED > Lamp Settings** and press **OK**. The **Lamp Settings** page appears. Highlight **Reset Lamp Timer** and press **OK**. A warning message is displayed asking if you want to reset the lamp timer. Highlight **Reset** and press **OK**. The lamp time will be reset to “0”.











- Do not reset if the lamp is not new or replaced as this could cause damage.



Indicators

Light			Status & Description
POWER 	TEMP 	LAMP 	
Power events			
			Stand-by mode
			Powering up
			Normal operation
			Normal power-down cooling
			Download
			CW start fail
Lamp events			
			Lamp error in normal operation
			Lamp is not lit up
			Lamp life exhausted
Thermal events			
			Fan 1 error (the actual fan speed is outside the desired speed)
			Fan 2 error (the actual fan speed is outside the desired speed)
			Fan 3 error (the actual fan speed is outside the desired speed)
			Fan 4 error (the actual fan speed is outside the desired speed)
			Temperature 1 error (over limited temperature)
			Thermal sensor 1 open error
			Thermal sensor short error
			Thermal IC #I2C connection error

	 : Off	 : Orange On  : Orange Flashing	 : Green On  : Green Flashing	 : Red On  : Red Flashing
-------------------------------------------------------------------------------------	-------------------------------------------------------------------------------------------	----------------------------------------------------------------------------------------------------------------------------------------------------------------------------------------------------------	--------------------------------------------------------------------------------------------------------------------------------------------------------------------------------------------------------	--------------------------------------------------------------------------------------------------------------------------------------------------------------------------------------------------------

Troubleshooting

? The projector does not turn on.

Cause	Remedy
There is no power from the power cord.	Plug the power cord into the AC power jack on the projector, and plug the power cord into the power outlet. If the power outlet has a switch, make sure that it is switched on.
Attempting to turn the projector on again during the cooling process.	Wait until the cooling down process has completed.

? No picture

Cause	Remedy
The video source is not turned on or connected correctly.	Turn the video source on and check that the signal cable is connected correctly.
The projector is not correctly connected to the input signal device.	Check the connection.
The input signal has not been correctly selected.	Select the correct input signal with the SOURCE key.
The lens cover is still closed.	Open the lens cover.

? Blurred image

Cause	Remedy
The projection lens is not correctly focused.	Adjust the focus of the lens using the focus ring.
The projector and the screen are not aligned properly.	Adjust the projection angle and direction as well as the height of the projector if necessary.
The lens cover is still closed.	Open the lens cover.

? Remote control does not work.

Cause	Remedy
The batteries are out of power.	Replace both of the batteries with new ones.
There is an obstacle between the remote control and the projector.	Remove the obstacle.
You are too far away from the projector.	Stand within 8 meters (26 feet) of the projector.

? The password is incorrect.

Cause	Remedy
You do not remember the password.	See Entering the password recall procedure on page 23 .

Specifications

Projector specifications



All specifications are subject to change without notice.

Optical

Resolution

1024 x 768 XGA (MX863UST)
1280 x 800 WXGA (MW864UST)

Display system

1-CHIP DMD

Lens

F = 2.4, f = 3.35 mm

Lamp

240 W lamp

Electrical

Power supply

AC100–240V, 3.9 A, 50–60 Hz (Automatic)

Power consumption

410 W (Max); < 0.5 W (Standby);
< 2 W (when the Network function in the Standby
Settings is on)

Mechanical

Weight

8 Kg (17.6 lbs) with projector mounting plate

Output terminals

RGB output

D-Sub 15-pin (female) x 1

Speaker

10 watt x 2

Audio signal output

PC audio jack x 1

Control

USB

PointWrite (Type-B mini USB)
(Optional for PointWrite kit)
Type-A power supply 5V /1.5 A
(Optional for PointWrite Touch module)

RS-232 serial control

9 pin x 1

LAN control

RJ45 x 1

IR receiver x 1

Input terminals

Computer input

RGB input
D-Sub 15-pin (female) x 2

Video signal input

S-VIDEO
Mini DIN 4-pin x 1

VIDEO

RCA jack x 1
SD/HDTV signal input
Analog - Component RCA jack x 3
(through RGB input)
Digital - HDMI x 1; HDMI/MHL x 1

Audio signal input

Audio in
RCA audio jacks (L/R) x 1
PC audio jack x 2

USB port (Mini-B x 1)

Environmental Requirements

Operating temperature

0°C–40°C at sea level

Storage temperature

-20°C–60°C at sea level

Operating/Storage relative humidity

10%–90% (without condensation)

Operating altitude

0–1499 m at 0°C–35°C
1500–3000 m at 0°C–30°C (with
High Altitude Mode on)

Dimensions

382 mm (W) x 145 mm (H) x 435 mm (D)

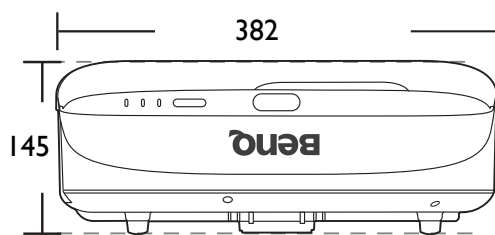
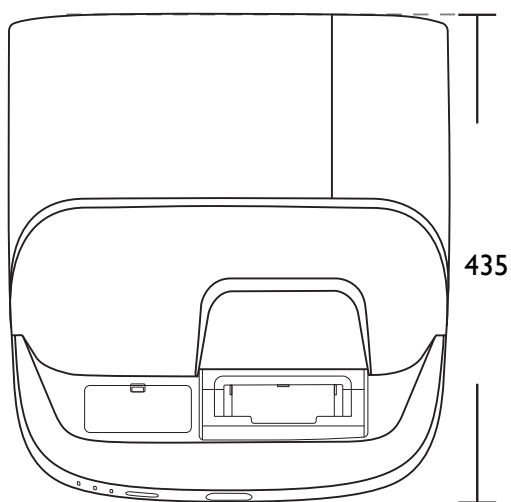

Unit: mm

Timing chart

Supported timing for PC input

Resolution	Mode	Vertical Frequency (Hz)	Horizontal Frequency (kHz)	Pixel Frequency (MHz)
640 x 480	VGA_60*	59.940	31.469	25.175
	VGA_72	72.809	37.861	31.500
	VGA_75	75.000	37.500	31.500
	VGA_85	85.008	43.269	36.000
720 x 400	720 x 400_70	70.087	31.469	28.3221
800 x 600	SVGA_60*	60.317	37.879	40.000
	SVGA_72	72.188	48.077	50.000
	SVGA_75	75.000	46.875	49.500
	SVGA_85	85.061	53.674	56.250
	SVGA_120** (Reduce Blanking)	119.854	77.425	83.000
1024 x 768	XGA_60*	60.004	48.363	65.000
	XGA_70	70.069	56.476	75.000
	XGA_75	75.029	60.023	78.750
	XGA_85	84.997	68.667	94.500
	XGA_120** (Reduce Blanking)	119.989	97.551	115.5
1152 x 864	1152 x 864_75	75	67.5	108
1024 x 576	BenQ Notebook_timing	60.0	35.820	46.966
1024 x 600	BenQ Notebook_timing	64.995	41.467	51.419
1280 x 720	1280 x 720_60*	60	45.000	74.250
1280 x 768	1280 x 768_60*	59.87	47.776	79.5
1280 x 800	WXGA_60*	59.810	49.702	83.500
	WXGA_75	74.934	62.795	106.500
	WXGA_85	84.880	71.554	122.500
	WXGA_120** (Reduce Blanking)	119.909	101.563	146.25
1280 x 1024	SXGA_60***	60.020	63.981	108.000
	SXGA_75	75.025	79.976	135.000
	SXGA_85	85.024	91.146	157.500
1280 x 960	1280 x 960_60***	60.000	60.000	108.000
	1280 x 960_85	85.002	85.938	148.500
1360 x 768	1360 x 768_60***	60.015	47.712	85.5
1400 x 1050	SXGA+_60***	59.978	65.317	121.750
1440 x 900	WXGA+_60***	59.887	55.935	106.500
1600 x 1200	UXGA***	60.000	75.000	162.000
1680 x 1050	1680 x 1050_60***	59.954	65.290	146.250
640 x 480@67Hz	MAC13	66.667	35.000	30.240
832 x 624@75Hz	MAC16	74.546	49.722	57.280
1024 x 768@75Hz	MAC19	74.93	60.241	80.000
1152 x 870@75Hz	MAC21	75.060	68.680	100.000



- *Supported timing for 3D signal in **Frame Sequential, Top Bottom** and **Side by Side** formats.
- **Supported timing for 3D signal in **Frame Sequential** format.
- ***Supported timing for 3D signal in **Top Bottom** and **Side by Side** formats.
- The timings showing above may not be supported due to EDID file and VGA graphic card limitations. It is possible that some timings cannot be chosen.

Supported timing for HDMI (HDCP) input

• PC timings

Resolution	Mode	Vertical Frequency (Hz)	Horizontal Frequency (kHz)	Pixel Frequency (MHz)
640 x 480	VGA_60*	59.940	31.469	25.175
	VGA_72	72.809	37.861	31.500
	VGA_75	75.000	37.500	31.500
	VGA_85	85.008	43.269	36.000
720 x 400	720 x 400_70	70.087	31.469	28.3221
800 x 600	SVGA_60*	60.317	37.879	40.000
	SVGA_72	72.188	48.077	50.000
	SVGA_75	75.000	46.875	49.500
	SVGA_85	85.061	53.674	56.250
	SVGA_120** (Reduce Blanking)	119.854	77.425	83.000
1024 x 768	XGA_60*	60.004	48.363	65.000
	XGA_70	70.069	56.476	75.000
	XGA_75	75.029	60.023	78.750
	XGA_85	84.997	68.667	94.500
	XGA_120** (Reduce Blanking)	119.989	97.551	115.5
1152 x 864	1152 x 864_75	75	67.5	108
1280 x 768	1280 x 768_60*	59.87	47.776	79.5
1024 x 576@60Hz	BenQ Notebook Timing	60.00	35.820	46.996
1024 x 600@65Hz	BenQ Notebook Timing	64.995	41.467	51.419
1280 x 720	1280 x 720_60*	60	45.000	74.250
1280 x 768	1280 x 768_60*	59.870	47.776	79.5
1280 x 800	WXGA_60*	59.810	49.702	83.500
	WXGA_75	74.934	62.795	106.500
	WXGA_85	84.880	71.554	122.500
	WXGA_120** (Reduce Blanking)	119.909	101.563	146.25
1280 x 1024	SXGA_60***	60.020	63.981	108.000
	SXGA_75	75.025	79.976	135.000
	SXGA_85	85.024	91.146	157.500
1280 x 960	1280 x 960_60***	60.000	60.000	108
	1280 x 960_85	85.002	85.938	148.500
1360 x 768	1360 x 768_60***	60.015	47.712	85.500
1440 x 900	WXGA+_60***	59.887	55.935	106.500
1400 x 1050	SXGA+_60***	59.978	65.317	121.750
1600 x 1200	UXGA***	60.000	75.000	162.000
1680 x 1050	1680 x 1050_60***	59.954	65.290	146.250
1920 x 1080@60Hz	1920 x 1080_60***	60	67.5	148.5
1920 x 1200	1920 x 1200_60*** (Reduce Blanking)	59.950	74.038	154.0000
640 x 480@67Hz	MAC13	66.667	35.000	30.240
832 x 624@75Hz	MAC16	74.546	49.722	57.280
1024 x 768@75Hz	MAC19	75.020	60.241	80.000
1152 x 870@75Hz	MAC21	75.06	68.68	100.00



- *Supported timing for 3D signal in **Frame Sequential**, **Top Bottom** and **Side by Side** formats.
- **Supported timing for 3D signal in **Frame Sequential** format.
- ***Supported timing for 3D signal in **Top Bottom** and **Side by Side** formats.
- The timings showing above may not be supported due to EDID file and VGA graphic card limitations. It is possible that some timings cannot be chosen.

• Video timings

Timing	Resolution	Vertical Frequency (Hz)	Horizontal Frequency (kHz)	Pixel Frequency (MHz)
480i*	720 x 480	59.94	15.73	27
480p*	720 x 480	59.94	31.47	27
576i	720 x 576	50	15.63	27
576p	720 x 576	50	31.25	27
720/50p**	1280 x 720	50	37.5	74.25
720/60p***	1280 x 720	60	45.00	74.25
1080/50i****	1920 x 1080	50	28.13	74.25
1080/60i****	1920 x 1080	60	33.75	74.25
1080/24P**	1920 x 1080	24	27	74.25
1080/25P	1920 x 1080	25	28.13	74.25
1080/30P	1920 x 1080	30	33.75	74.25
1080/50P*****	1920 x 1080	50	56.25	148.5
1080/60P*****	1920 x 1080	60	67.5	148.5



- *Supported timing for 3D signal in **Frame Sequential** format.
- **Supported timing for 3D signal in **Top Bottom, Frame Packing** and **Side by Side** formats.
- ***Supported timing for 3D signal in **Frame Sequential, Top Bottom, Frame Packing** and **Side by Side** formats.
- ****Supported timing for 3D signal in **Side by Side** format.
- *****Supported timing for 3D signal in **Top Bottom** and **Side by Side** formats.

Supported timing for MHL input

Timing	Resolution	Vertical Frequency (Hz)	Horizontal Frequency (kHz)	Pixel Frequency (MHz)
480i	720 (1440) x 480	59.94	15.73	27
480p	720 x 480	59.94	31.47	27
576i	720 (1440) x 576	50	15.63	27
576p	720 x 576	50	31.25	27
720/50p	1280 x 720	50	37.5	74.25
720/60p	1280 x 720	60	45.00	74.25
1080/24P	1920 x 1080	24	27	74.25
1080/25P	1920 x 1080	25	28.13	74.25
1080/30P	1920 x 1080	30	33.75	74.25
1080/50i	1920 x 1080	50	28.13	74.25
1080/60i	1920 x 1080	60	33.75	74.25
1080/50p	1920 x 1080	50	56.25	148.5
1080/60p	1920 x 1080	60	67.5	148.5

Supported timing for Component-YPbPr input

Timing	Resolution	Vertical Frequency (Hz)	Horizontal Frequency (kHz)	Pixel Frequency (MHz)
480i*	720 x 480	59.94	15.73	13.5
480p*	720 x 480	59.94	31.47	27
576i	720 x 576	50	15.63	13.5
576p	720 x 576	50	31.25	27
720/50p	1280 x 720	50	37.5	74.25
720/60p*	1280 x 720	60	45.00	74.25
1080/50i	1920 x 1080	50	28.13	74.25
1080/60i	1920 x 1080	60	33.75	74.25
1080/24P	1920 x 1080	24	27	74.25
1080/25P	1920 x 1080	25	28.13	74.25
1080/30P	1920 x 1080	30	33.75	74.25
1080/50P	1920 x 1080	50	56.25	148.5
1080/60P	1920 x 1080	60	67.5	148.5



- *Supported timing for 3D signal in **Frame Sequential** format.
- Displaying a 1080i(1125i)@60Hz or 1080i(1125i)@50Hz signal may result in slight image vibration.

Supported timing for Video and S-Video inputs

Video mode	Horizontal Frequency (kHz)	Vertical Frequency (Hz)	Color sub-carrier Frequency (MHz)
NTSC*	15.73	60	3.58
PAL	15.63	50	4.43
SECAM	15.63	50	4.25 or 4.41
PAL-M	15.73	60	3.58
PAL-N	15.63	50	3.58
PAL-60	15.73	60	4.43
NTSC4.43	15.73	60	4.43



- Supported timing for 3D signal in **Frame Sequential** format.