



LU9715  
Digital Projector  
User Manual



## Table of Contents

<b>Important safety guidelines .....</b>	<b>5</b>
Safety notification .....	5
Warning to California residents .....	5
Notification (Canada).....	5
CE notification.....	5
FCC notification.....	6
Light module.....	6
Laser safety notification and caution .....	6
Interlock switches protection .....	7
Laser parameters .....	7
Product label .....	8
Hazard warning symbol and aperture label.....	8
Warning.....	9
China RoHS.....	10
<b>Important safety instructions .....</b>	<b>11</b>
<b>Overview .....</b>	<b>14</b>
<b>Shipping contents .....</b>	<b>14</b>
<b>Projector exterior view .....</b>	<b>15</b>
Front and upper side view .....	15
Rear and upper side view.....	15
<b>IO panel.....</b>	<b>16</b>
<b>Control panel and functions.....</b>	<b>17</b>
Notes on remote controller operation.....	19
Remote control operation.....	19
<b>Setup and Operation .....</b>	<b>20</b>
<b>Install remote controller battery .....</b>	<b>20</b>
<b>Connecting to the projector .....</b>	<b>20</b>
<b>Projection lens selection and Installation.....</b>	<b>21</b>
Installing or removing the optional lens .....	21
Installing the new lens .....	21
<b>Removing the existing lens from the projector .....</b>	<b>22</b>
<b>Choosing a location .....</b>	<b>23</b>
<b>Projection distance and screen size .....</b>	<b>24</b>
<b>Lens shift adjustable range.....</b>	<b>26</b>
<b>Making connections .....</b>	<b>27</b>
Preparations .....	27
Connect to PC .....	27
Connect to video equipment.....	28
Connect to control port.....	28
Connect to screen trigger .....	29
Connect to external digital transmitter.....	30
<b>Using the projector .....</b>	<b>31</b>





<b>Preparations .....</b>	<b>31</b>
<b>Turning the projector on or off.....</b>	<b>32</b>
<b>Selecting an input source .....</b>	<b>33</b>
<b>Using the menus .....</b>	<b>34</b>
Adjusting the image position .....	34
<b>Fine-tuning the image size and clarity .....</b>	<b>35</b>
<b>Adjusting the projection angle .....</b>	<b>35</b>
<b>Correcting picture distortion .....</b>	<b>36</b>
Auto-adjusting the image.....	36
<b>Turning off the projector.....</b>	<b>37</b>
<b>Using On-Screen Display.....</b>	<b>38</b>
Using the Menus.....	38
Navigating the OSD.....	38
<b>On-Screen Display (OSD) menus.....</b>	<b>39</b>
<b>OSD menu - Picture .....</b>	<b>46</b>
<b>OSD menu - Display .....</b>	<b>47</b>
<b>OSD menu - Setup.....</b>	<b>51</b>
<b>OSD menu - Advanced.....</b>	<b>54</b>
<b>OSD menu - System .....</b>	<b>56</b>
<b>OSD menu - Information .....</b>	<b>58</b>
<b>Additional information .....</b>	<b>59</b>
<b>Cleaning the lens.....</b>	<b>59</b>
<b>Care of the projector.....</b>	<b>59</b>
Cleaning the projector case.....	59
Storing the projector .....	59
<b>Specifications.....</b>	<b>60</b>
<b>Dimension.....</b>	<b>61</b>
<b>Timing chart.....</b>	<b>62</b>
<b>3D supported timing .....</b>	<b>63</b>
<b>RS232 command control.....</b>	<b>65</b>
<b>Control the projector through network.....</b>	<b>75</b>
Set up the projector for networking.....	75
Control the projector through web browser .....	76
Projector status .....	76
Projector control .....	77
Crestron RoomView .....	77
Network setup .....	79
Alert mail setup.....	80
<b>Troubleshooting .....</b>	<b>81</b>
Indicator messages.....	81
Common problems and solutions.....	82
Tips for troubleshooting.....	82
Image problems .....	82
Remote control problems.....	83

<b>BenQ ecoFACTS</b> .....	<b>84</b>
Copyright .....	85
Disclaimer .....	85
Patents .....	85
Statement regarding hyperlinks and third-party websites .....	85
<b>About the BENQ Support</b> .....	<b>86</b>

## Important safety guidelines

Thank you for purchasing the high quality product! Read the Manual carefully to obtain the best performance. The Manual provides instructions to use the menu and implement operation.

### Safety notification

	<b>CAUTION</b> To turn off main power, ensure to unplug from power outlet.
	<b>CAUTION</b> To prevent electric shock, do not open the cabinet. There are high-voltage components inside. Refer service to qualified service personnel.
	<b>CAUTION</b> The symbol warns the user about electric shock caused by voltage not insulated. Therefore, it is dangerous to make any kind of contact with any parts of inside units.
	<b>WARNING!</b> This symbol alerts the user that important information which should be read carefully to avoid problems concerning the operation and maintenance.
	<b>WARNING!</b> To prevent the projector from electrical discharge or electric shock, do not expose the projector to rain or moist environment. Do not use the plug with an extension cord or an outlet unless all the prongs can be fully inserted.

### Warning to California residents

Handling the cables supplied with this equipment might expose user to a little lead, a chemical known to the State of California, resulting in risks of barrenness. Please remember to wash hands after handling.

### Notification (Canada)

This class A digital equipment complies with Canadian CAN ICES-3 (A).

### CE notification

This is a class A product. In a domestic environment this product may cause radio interference in which case the user may be required to take adequate measures.

## FCC notification

This equipment has been tested and found to comply with the limits for a Class A digital device, pursuant to Part 15 of the FCC Rules. These limits are designed to provide reasonable protection against harmful interference when the equipment is operated in a commercial environment. This equipment generates, uses, and can radiate radio frequency energy, and if it is not installed and used in accordance with the instruction manual, it may cause harmful interference to radio communications. Operation of this equipment in a residential area is likely to cause harmful interference, in which case the user will be required to correct the interference at his own expense.

Operation is subject to the following two conditions:

- 1) this device may not cause interference and
- 2) this device must accept any interference received, including interference that may cause undesired operation of the device

FCC Caution: Any changes or modifications not expressly approved by the party responsible for compliance could void the user's authority to operate this equipment.



### **WARNING!**

Changes or modifications without approval from BenQ could void the users authorization to operate the product.

## Light module

- A light module containing multiple laser diodes acts as the light source in the product.
- These laser diodes are sealed in the light module. It is recommended to ask dealer for maintenance or repair services of the light module.
- End user is not allowed to replace the light module.
- Contact distributor who provides the qualified service for light module replacement and further information.

## Laser safety notification and caution



- CLASS 3R LASER PRODUCT
- This Laser Product is designated as Class 3R during all procedures of operation.
- LASER LIGHT - AVOID DIRECT EYE EXPOSURE.
- Do not point laser or allow reflected laser light toward other people or reflective objects.
- Direct or scattered light can be hazardous to eyes and skin.
- There is a potential hazard of eye exposure to laser radiation if the included instructions are not followed.
- Caution – use of controls, adjustments or performance of procedures other than those specified herein may result in hazardous radiation exposure.

## Interlock switches protection

SWITCH A: Will be activated when the top cover is removed.

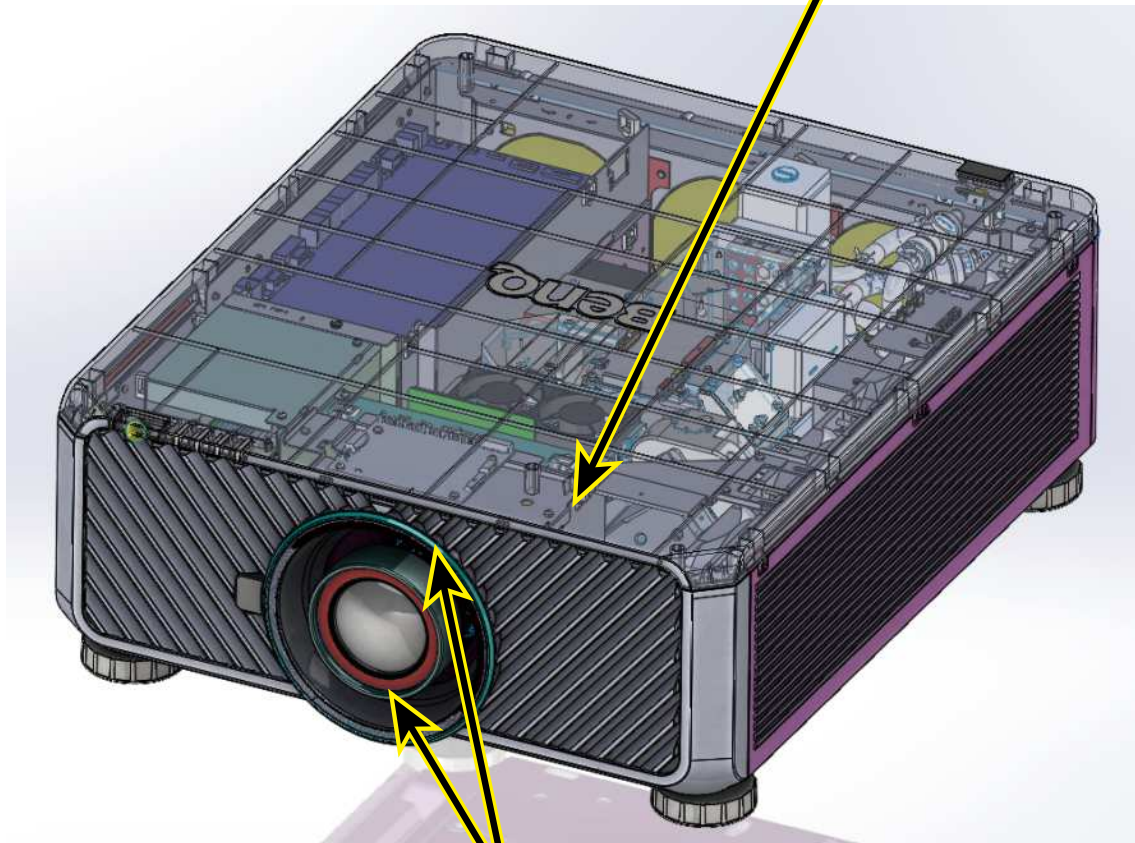

SWITCH B(x2): Will be activated when the projection lens is removed.

## Laser parameters

Blue Laser Diode Wavelength: 450nm - 460nm

Mode of Operation: Pulsed, due to frame rate

Pulse width: 0.74ms

Pulse repetition rate: 240Hz

Maximum laser energy: 0.376mJ

Total internal power: >100W

Apparent source size: >10mm, at lens stop

Divergence: >100 mili Radian

# Product label

Manufacturer's ID Label, Explanatory Label and Certification Statement Label.

 <p>BenQ Corporation 16 Jihu Road, Neihu, Taipei 114, Taiwan</p> <p>委製及進口商: 明基電通 台北市114內湖區基湖路 16號</p> <p>(For EU) IMPORTER: BENQ Europe B.V. Meerenakkerweg 1-17, 5652 AR, Eindhoven, the Netherlands</p>	<p>Product Name / Nom du produit / 品名 : Digital Projector / Projecteur digital / 數位投影機 Model Name / Nom du modèle / 型號 : LU9715 P/N / 產品料號 : 9HJJEV77.26E Rev. / 版本 : [Redacted]</p> <p>Power Rating / Nilai Daya / Puissance nominale / 額定電壓/頻率/電流 : 100-130V ~, 50/60Hz, 9.50A</p> <p>Power Rating / Nilai Daya / Puissance nominale / 額定電壓/頻率/電流 : 200-240V ~, 50/60Hz, 4.50A</p>	<p>Laite on liitettävä suojakoskettimilla varustettuun pistorasiaan Apparatet må tilkoples jordat stikkontakt Apparatet skall anslutas till jordat uttag Apparatets stikprop skal tilsluttes en stikkontakt med jord, som giver forbindelse til stikproppens jord CAN ICES-3(A) / NMB-3(A)</p> <p>CE EAC US LISTED E5876 IEC PROTECTOR</p> <p>In China / Fabriqué en Chine / 製造產地: 中國</p>	<p>Complies with FDA performance standards for laser products except for deviations pursuant to Laser Notice No. 50, dated June 24, 2007</p> 
		<div style="border: 2px solid black; padding: 5px;"> <p><b>LASER RADIATION</b> AVOID DIRECT EYE EXPOSURE CLASS 3R LASER PRODUCT Emitted wavelength: 450-460 nm Max. Pulse energy: 0.376 mJ, Pulse duration: 0.74 ms</p> <p>激光輻射 避免眼睛受到直接照射 3R 激光產品 波長: 450-460 nm 最大脈沖能量: 0.376 mJ, 脈沖時間: 0.74 ms</p> <p><b>RAYONNEMENT LASER</b> EXPOSITION DIRECTE DANGEREUSE POUR LES YEUX APPAREIL À LASER DE CLASSE 3R longueur d'onde: 450-460nm maximum énergie de impulsion: 0.376 mJ, durée de impulsion: 0.74 ms</p> <p>GB 7247.1-2012 / IEC/EN 60825-1:2007</p> </div>	

<p><b>CAUTION</b> Possibly hazardous optical radiation emitted from this product. Do not stare at operating lamp. May be harmful to the eyes.</p>	<p><b>ATTENTION</b> Ce produit peut émettre des rayonnements optiques dangereux. Ne pas fixer la lampe en fonctionnement. Peut être nocif pour les yeux.</p>	
---	--	---

 <p>型号: LU9715 品名: 数码投影机 企业标准号: Q/SIQ825 产品料号: 9HJJEV77.26C 制造产地: 中国 制造商: 明基电通有限公司 地址: 上海市长宁区淞虹路207号D栋1楼 服务热线: (0512) 68073600 版本: [Redacted]</p> <p>額定電壓/頻率/電流: 100-130V ~, 50/60Hz, 9.50A 額定電壓/頻率/電流: 200-240V ~, 50/60Hz, 4.50A</p>	<p>警告: 此为A级产品, 在生活环境中, 该产品可能会造成无线电干扰。在这种情况下, 可能需要用户对干扰采取切实可行的措施。</p> <p>CCC 10</p>	<p>Complies with FDA performance standards for laser products except for deviations pursuant to Laser Notice No. 50, dated June 24, 2007</p> 
	<p>3264625101 WJ XXXX</p>	<div style="border: 2px solid black; padding: 5px;"> <p><b>LASER RADIATION</b> AVOID DIRECT EYE EXPOSURE CLASS 3R LASER PRODUCT Emitted wavelength: 450-460 nm Max. Pulse energy: 0.376 mJ, Pulse duration: 0.74 ms</p> <p>激光輻射 避免眼睛受到直接照射 3R 激光產品 波長: 450-460 nm 最大脈沖能量: 0.376 mJ, 脈沖時間: 0.74 ms</p> <p><b>RAYONNEMENT LASER</b> EXPOSITION DIRECTE DANGEREUSE POUR LES YEUX APPAREIL À LASER DE CLASSE 3R longueur d'onde: 450-460nm maximum énergie de impulsion: 0.376 mJ, durée de impulsion: 0.74 ms</p> <p>GB 7247.1-2012 / IEC/EN 60825-1:2007</p> </div>

<p><b>CAUTION</b> Possibly hazardous optical radiation emitted from this product. Do not stare at operating lamp. May be harmful to the eyes.</p>	<p><b>ATTENTION</b> Ce produit peut émettre des rayonnements optiques dangereux. Ne pas fixer la lampe en fonctionnement. Peut être nocif pour les yeux.</p>	
---	--	---

# Hazard warning symbol and aperture label



**LASER APERTURE**  
激光辐射窗口  
**OUVERTURE LASER**



## Warning

Please make sure the Voltage Switch is selected at the right voltage in the region where projector is being used.

### Note

Default setting is 230V.

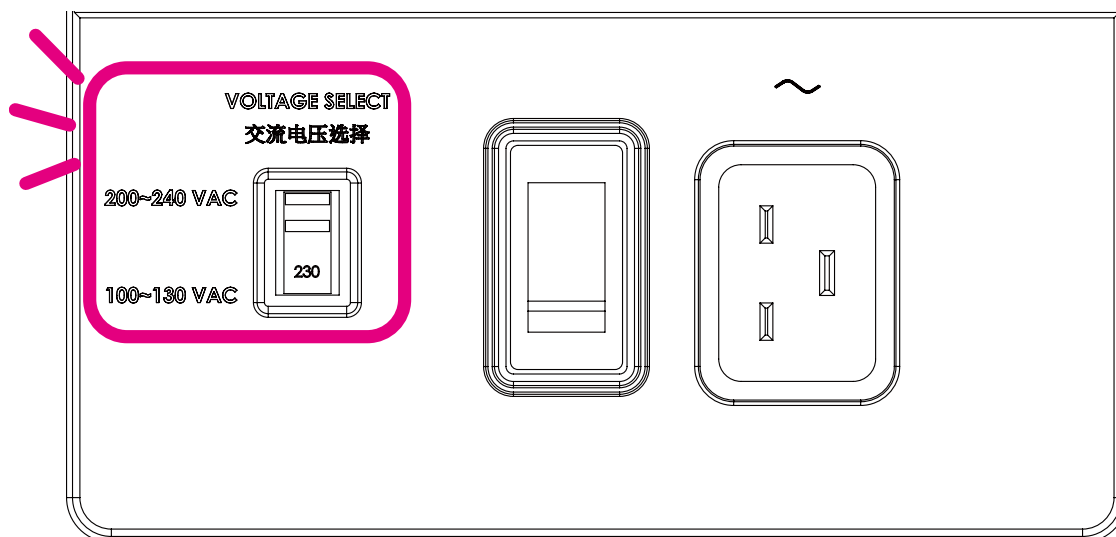

Please refer to below Table for the names and contents of the toxic or hazardous substances or elements contained in electronic information products.

## China RoHS

### Marking Styles for Names and Contents of Toxic or Hazardous Substances or Elements

Part Name	Toxic or hazardous Substances and Elements						
	Lead (Pb)	Mercury (Hg)	Cadmium (Cd)	Hexavalent Chromium (Cr(VI))	Polybrominated Biphenyls (PBB)	Polybrominated Diphenyl ethers (PBDE)	
Optical Engine	○	○	○	○	○	○	
Optical Module	x	○	○	○	○	○	
Fans Assy	x	○	○	○	○	○	
Metal Bracket	○	○	○	○	○	○	
Plastic Bracket	○	○	○	○	○	○	
Metal (Copper Pillars, Copper Nut, etc.)	x	○	○	○	○	○	
Temperature Switch	○	○	○	○	○	○	
PCB Assy	x	○	○	○	○	○	
Cable	○	○	○	○	○	○	
Power Cord	○	○	○	○	○	○	
Power Inlet	○	○	○	○	○	○	
Remote Controller	x	○	○	○	○	○	

O: Indicates that this toxic or hazardous substance contained in all of the homogeneous materials for this part is below the limit requirement in SJ/T 11364-2006.

X: Indicates that this toxic or hazardous substance contained in at least one of the homogeneous materials used for this part is above the limit requirement in SJ/T 11364-2006.

(Enterprises may further provide in this box technical explanation for marking "X" based on their actual conditions.)

Thank you for your purchase of this quality BenQ projector. For the best results, please read through this manual carefully as it is your guide through the control menus and operation.

## Important safety instructions

1. Please read this user manual before you operate your projector. Keep this manual in a safe place for future reference.

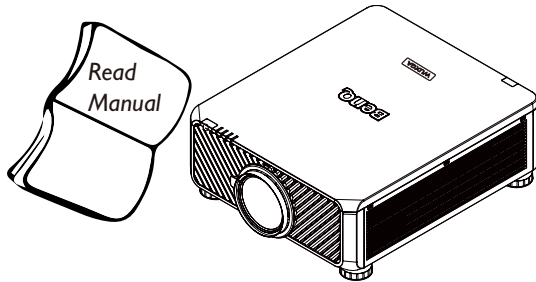

2. Always place the projector on a level, horizontal surface during operation.
  - Do not place the projector on an unstable cart, stand, or table as it may fall and be damaged.
  - Do not place inflammables near the projector.
  - Do not use if tilted at an angle of more than 10 degrees left to right, nor at angle of more than 15 degrees front to back.

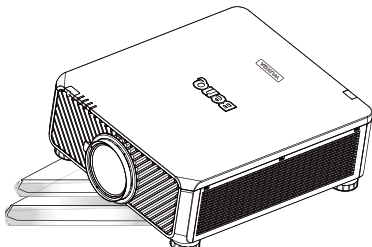

3. Do not store the projector on end vertically. Doing so may cause the projector to fall over, causing injury or resulting in damage.

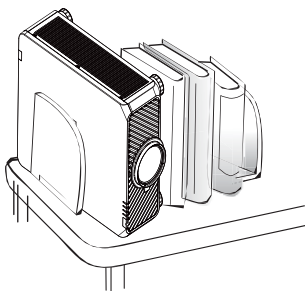

4. Do not place the projector in any of the following environments:
  - space that is poorly ventilated or confined. At least 50 cm clearance from walls and free flow of air around the projector is recommended.
  - locations where temperatures may become excessively high, such as the inside of a car with all windows closed.
  - locations where excessive humidity, dust, or cigarette smoke may contaminate optical components, shorten the projector's lifespan and darken the screen.

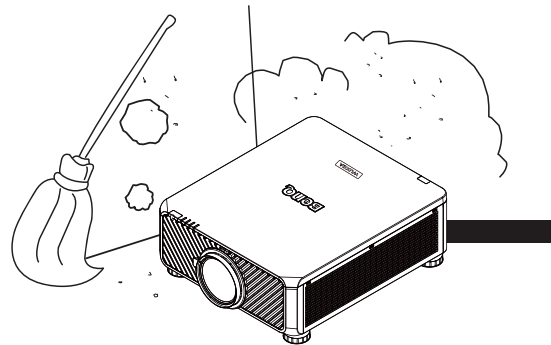

- locations near fire alarms.
- locations with an ambient temperature above 35°C/95°F.
- locations where altitude is higher than 1500 meters/4920 feet above sea level.

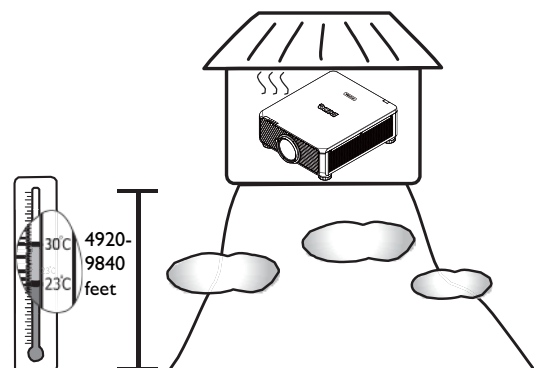

5. Do not block the vents holes while the projector is on (even in standby mode):
- Do not cover the projector with any item.
  - Do not place the projector on a blanket, bedding or any other soft surface.

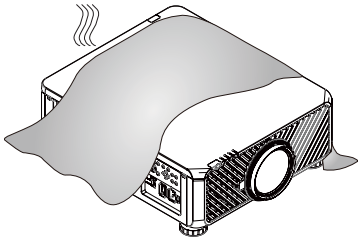

6. In areas where the mains power supply voltage may fluctuate by  $\pm 10$  volts, it is recommended that you connect your projector through a power stabilizer, surge protector or uninterruptible power supply (UPS) as appropriate to your situation.

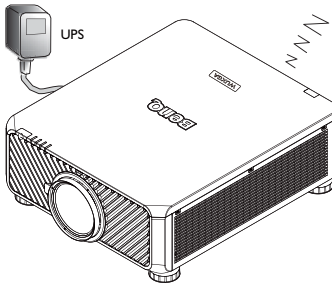

7. Do not step on the projector or place any objects upon it.

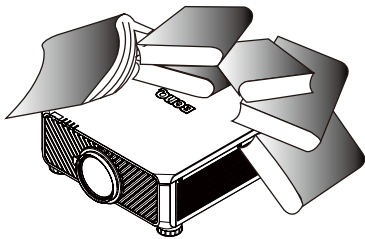

8. Do not place liquids near or on the projector. Liquids spilled into the projector will void your warranty. If the projector does become wet, disconnect it from the power point and call BenQ to have the projector repaired.

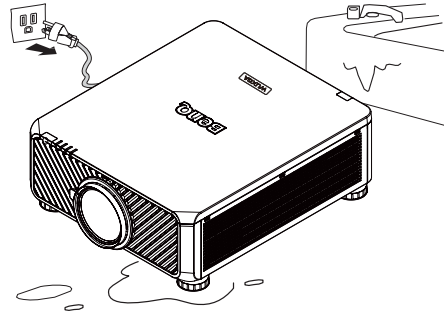

9. Do not look straight to the projector lens during operation. It may harm your sight.

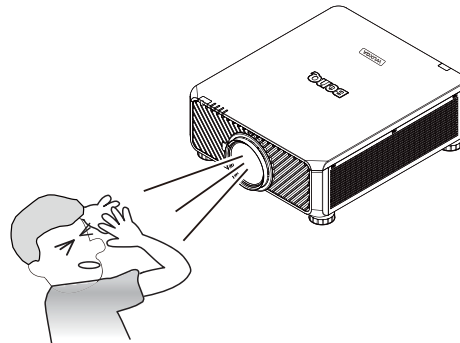

10. This projector is capable of displaying inverted images for ceiling mount installation. Use only BenQ's Ceiling Mount Kit for mounting.

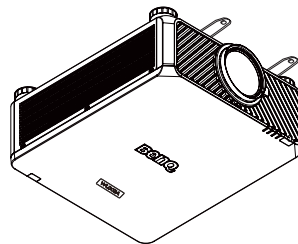

11. When you think service or repair is required, take the projector only to a suitably qualified technician.

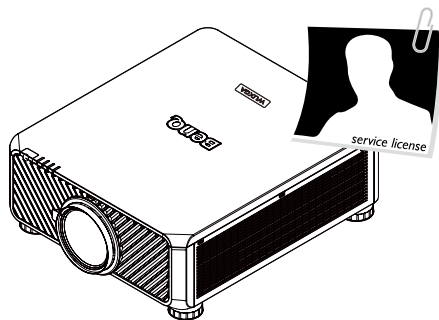

12. Do not attempt to disassemble this projector. There are dangerous high voltages inside which may cause death if you should come into contact with live parts. Under no circumstances should you ever undo or remove any other covers. Refer servicing only to suitably qualified professional service personnel.

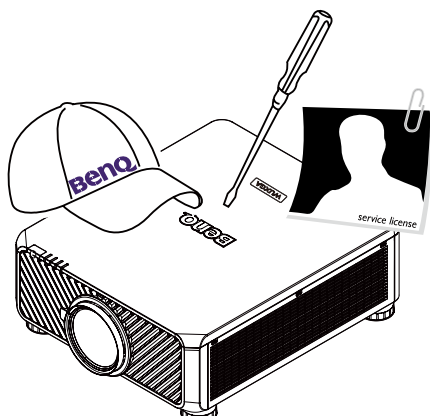

Please keep the original packing for possible future shipment.

# Overview

## Shipping contents

Carefully unpack and verify that you have the items below. Some of the items may not be available depending on your region of purchase. Please check with your place of purchase.



Some of the accessories may vary from region to region.

The warranty card is only supplied in some specific regions. Please consult your dealer for detailed information.

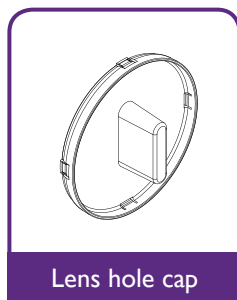
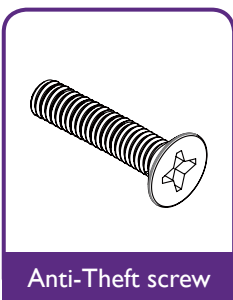
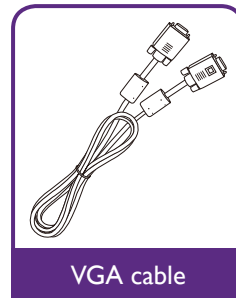
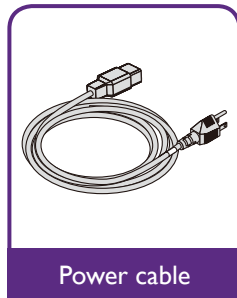
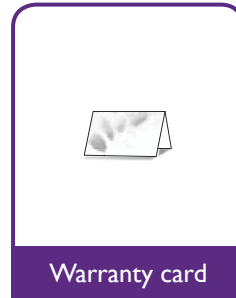

## Projector exterior view

### Front and upper side view

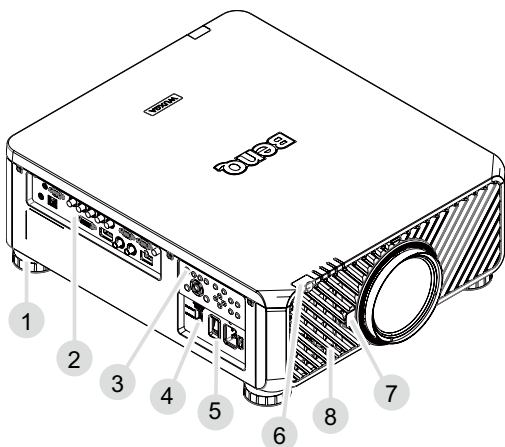

1. Foot for adjusting projector level
2. IO panel
3. Control panel
4. Slide switch (voltage selection)
5. AC power switch
6. Front IR sensor
7. Lens release button
8. Air intake

### Rear and upper side view

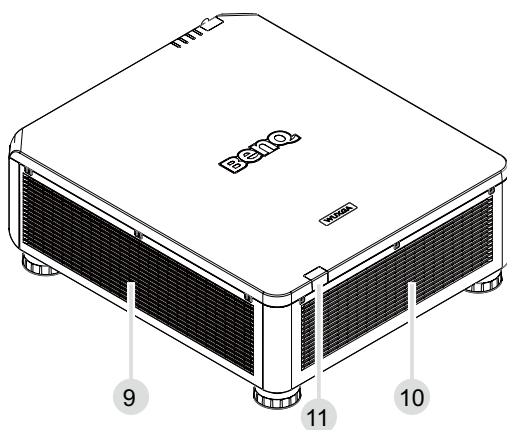

9. Air intake
10. Air exhaust
11. Rear IR sensor

# IO panel

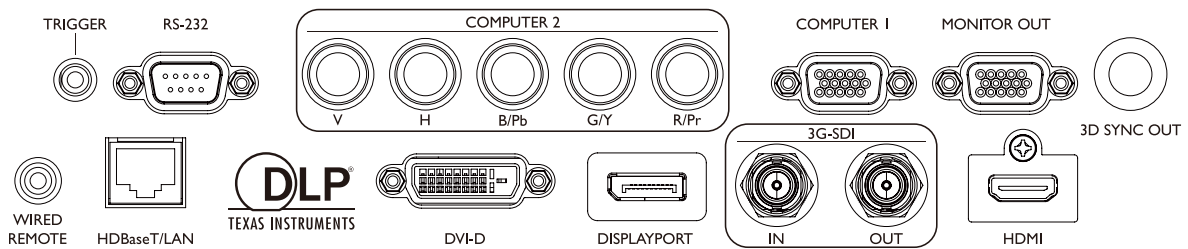

- **HDBaseT/LAN**  
For connection to RJ45 Cat5/Cat6 Ethernet cable to input uncompressed high-definition video (HD), control signals.
- **3D Sync Out**  
Connection to 3D IR sync signal transmitter.
- **DVI-D**  
Connection to DVI-D source.
- **HDMI**  
Connection to HDMI source.
- **DisplayPort**  
Connection to device or PC featuring DisplayPort.
- **3G-SDI**  
Connection to 3G-SDI source.
- **Computer 1**  
15-pin VGA port for connection to RGB, component HD source, or PC.
- **Computer 2 (V, H, B/Pb, G/Y, R/Pr)**  
Connection to RGB or YPbPr/YCbCr output signal with BNC type input terminal.
- **Monitor Out**  
Connection to other display equipment for concurrent playback display.
- **RS-232**  
Standard 9-pin D-sub interface for connection to PC control system and projector maintenance.
- **TRIGGER**  
3.5mm mini earphone jack, employs 350mA display relay to provide 12(+/-1.5)V output and short circuit protection.
- **Wired Remote**  
Connection to input Niles or Xantech compatible IR repeater system.

## Caution

Make sure the port is valid before inserting a wired remote controller. The remote controller may be damaged in case of an invalid port, e.g. a wired remote controller is connected to trigger output.



## Control panel and functions

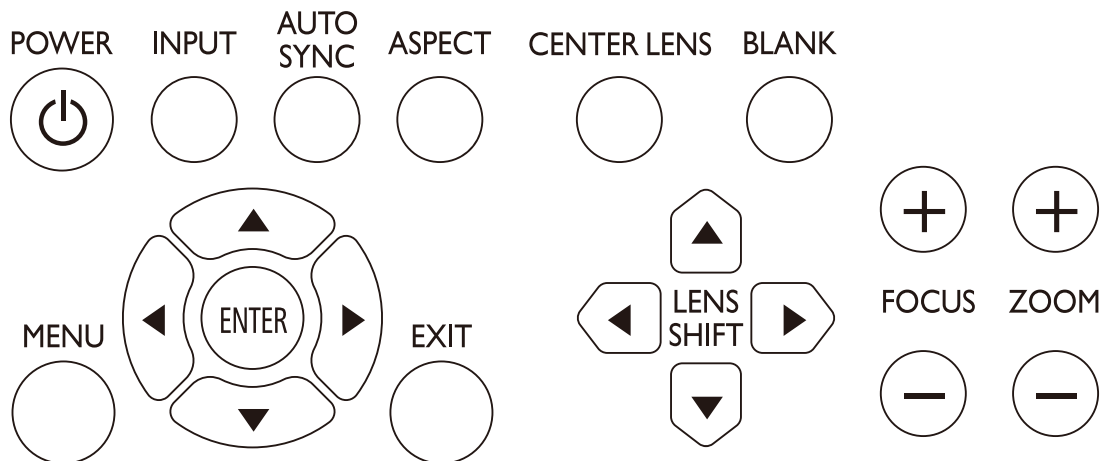

- **POWER**  
Press to power on/off your projector.
- **INPUT**  
Press to select video sources including HDMI, DVI-D, Computer 1, Computer 2, DisplayPort and HDBaseT.
- **AUTO SYNC**  
Press to execute auto signal sync.
- **ASPECT**  
Press to switch aspect ratio of current image.
- **MENU**  
Press to display OSD menu or return to the upper menu level.
- **ENTER**  
Press to select, accept or change settings.
- **EXIT**  
Press to exit OSD menu.
- **CENTER LENS**  
Press to center the lens and reset its shift, focus and zoom parameters.

### Note

The lens memory requires precise lens parameter adjustments. Please re-run the Center Lens function once you install the lens.

- **BLANK**  
Press the button to temporarily interrupt the projection.
- **LENS SHIFT**  
Press to move lens up, down, left and right.
- **FOCUS**  
Press to adjust focus of projection image.
- **ZOOM**  
Press to zoom in and out on projection image.

## Remote control and functions

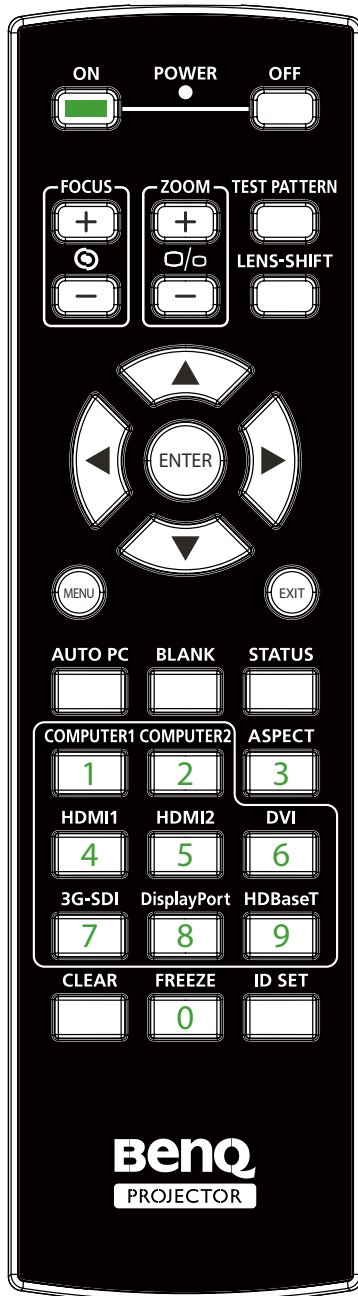

- **ON**  
Press to power on projector.
- **OFF**  
Press to power off projector.
- **FOCUS +/-**  
Press to adjust focus of projection image.
- **ZOOM +/-**  
Press to zoom in and out on projection image.
- **TEST PATTERN**  
Press to display embedded test pattern. Press continuously to scroll through available ones. Press MENU key to exit to projection image.
- **LENS SHIFT**  
Press to move lens up, down, left and right.
- **ENTER**  
Press to select or accept settings.
- **MENU**  
Press to display OSD menu or return to the upper menu level.
- **EXIT**  
Press to exit OSD menu.
- **AUTO PC**  
Press to execute auto signal sync.
- **BLANK**  
Press the button to temporarily interrupt the projection.
- **STATUS**  
Show OSD MENU – Information.
- **COMPUTER 1**  
Select COMPUTER 1 input source.
- **COMPUTER 2**  
Select COMPUTER 2 input source.
- **ASPECT**  
Press continuously to scroll through individual aspect ratio.
- **HDMI 1**  
Select HDMI 1 input source.
- **HDMI 2**  
Function same as HDMI 1
- **DVI**  
Select DVI input source.
- **3G-SDI**  
Select 3G-SDI input source.
- **Display Port**  
Select Display Port input source.
- **HDBaseT**  
Select HDBaseT input source.
- **CLEAR: Not available with this model.**
- **FREEZE**  
Press to toggle switch between freeze and unfreeze.
- **ID SET:**  
Not available for this model.

## Notes on remote controller operation

- Some environment factor may hamper the operation of remote controller. If so, point remote controller at the projector and repeat the operation again.
- In case the effective range of the remote controller is shortened or the remote controller stops functioning, please replace the battery with a new one.
- The projector enters wired control mode automatically and cannot be controlled by the remote controller's IR signal, once the cable terminal of a remote controller is inserted in the projector's wired control port. To control the projector with the IR signal of the remote controller again, remove the wire control terminal from the projector.
- IR signal may be interrupted and rendered useless when the remote controller is exposed to bright sunlight or fluorescent light. Make sure the installation environment is proper for IR remote controller.

## Remote control operation

- Make sure that there is nothing positioned between the remote control and the infrared (IR) sensors on the projector that might obstruct the IR beam from the remote control reaching the projector.
- The effective range of the remote control is up to 7 meters, and at an angle within 30 degrees of the IR beam. Always aim straight at the projector, however most screens will also reflect the IR beam to the projector.

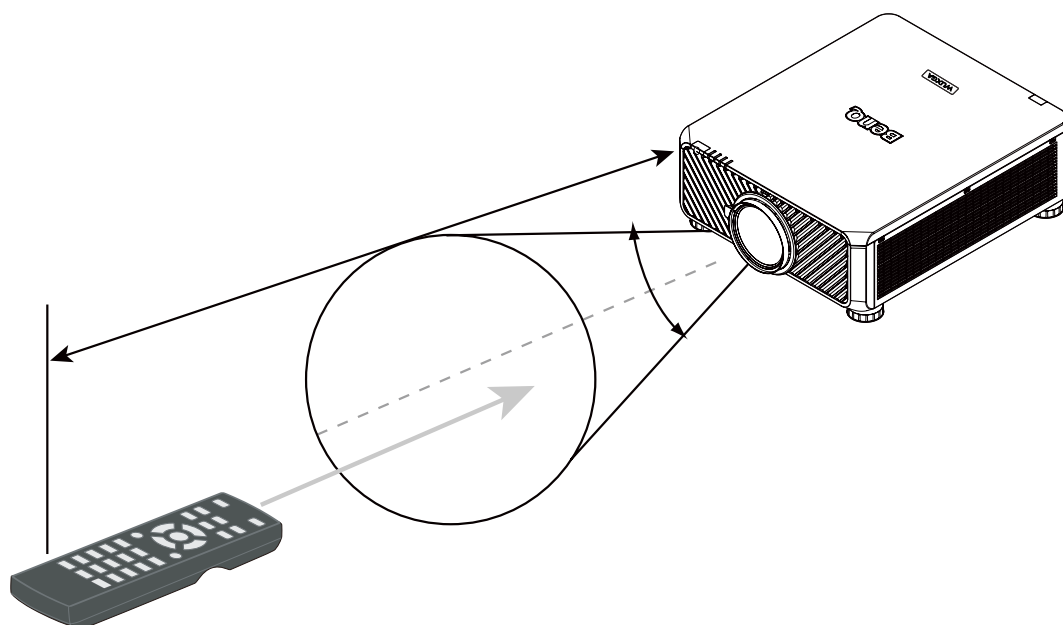

### Caution:

DO NOT expose your remote controller to high temperatures or moisture or it may function abnormally.

# Setup and Operation

## Install remote controller battery

1. To open the battery cover, turn the remote control over to view its back, push on the finger grip on the cover and slide it up in the direction of the arrow as illustrated. The cover will slide off.
2. Remove any existing batteries (if necessary) and install two new AA batteries observing the battery polarities as indicated in the base of the battery compartment. Positive (+) goes to positive and negative (-) goes to negative.
3. Refit the cover by aligning it with the case and sliding it back up into position. Stop when it clicks into place.

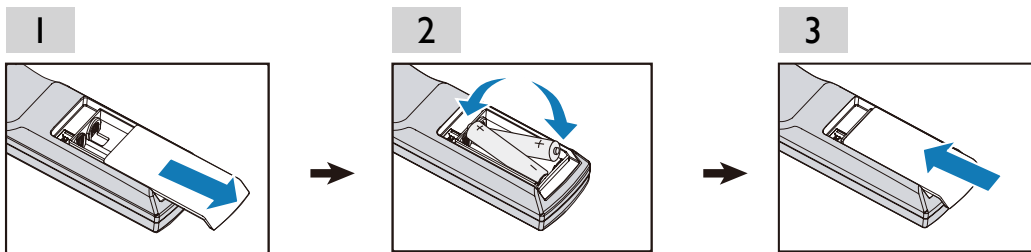

### Precautions relating to batteries

- Do not mix old batteries with new ones, or mix different types of batteries.
- Avoid leaving the remote control and batteries in an excessive hot or humid environment like the kitchen, bathroom, sauna, sunroom, or a closed car.
- Dispose of used batteries according to the battery manufacturer's instructions and local environment regulations for your region.
- If the remote control will not be used for an extended period of time, remove the batteries to avoid damage to the control from possible battery leakage.

## Connecting to the projector

If the path between the remote control and the projector is obstructed or remote control operation is disrupted by certain high-frequency fluorescent lights, you can connect to the projector with M3 stereo mini jack cable to operate the projector.

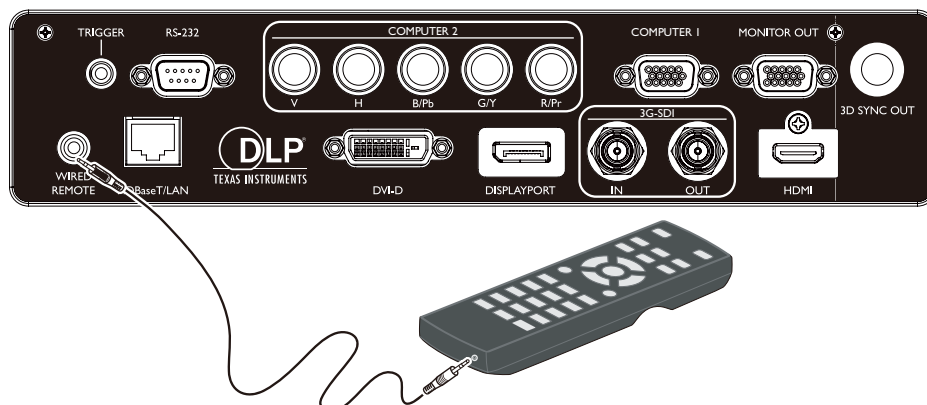

# Projection lens selection and Installation

## Note:

When installing the lens into the projector, be sure to remove the lens cap from the back of the optional lens before installing the optional lens into the projector. Failure to do so will cause damage to the projector.

## Installing or removing the optional lens

### Installing the new lens

1. Remove the lens cap.

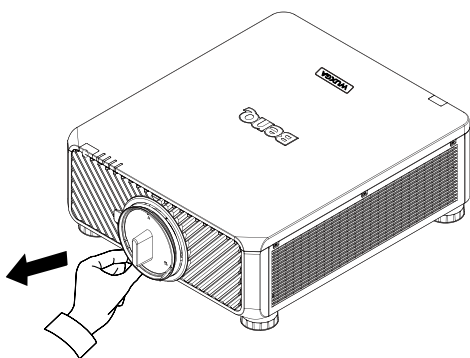

2. Insert the lens from the direction as arrow marked below then rotate the lens clockwise until clicking sound twice.

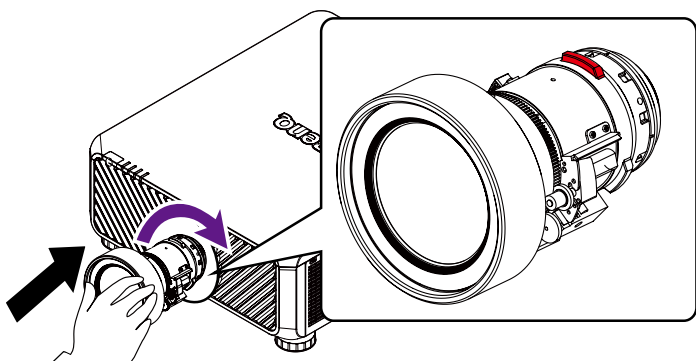

3. Using the anti-theft screw to prevent theft of the lens. Tighten the supplied anti-theft screw on the front bottom.

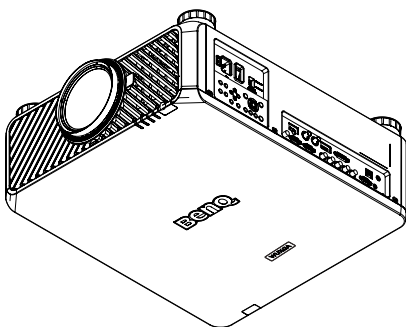

## Caution

- Please install lens first, and then turn on the projector.

## Removing the existing lens from the projector

1. Push the Lens Release button all the way in and rotate the lens counterclockwise, and the existing lens will be disengaged.

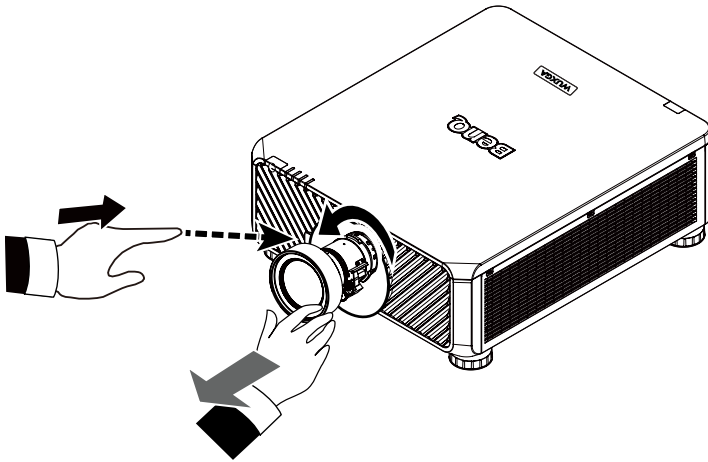

2. Pull out the existing lens slowly.

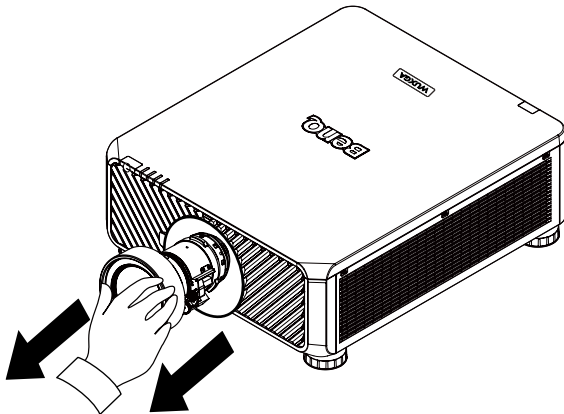

### Note:

- Do not shake or place excessive pressure on the projector or the lens components as the projector and lens components contain precision parts.
- Before removing or installing the lens, be sure to turn off the projector, wait until the cooling fans stop, and turn off the main power switch.
- Do not touch the lens surface when removing or installing the lens.
- Keep fingerprints, dust or oil off the lens surface. Do not scratch the lens surface.
- If you remove and store the lens, attach the lens cap to the projector to keep off dust and dirt.

### Caution

- Please turn off projector when changing or removing lens, or it will cause the projector shut down immediately without normal procedure.

## Choosing a location

Your projector is designed to be installed in one of four possible installation locations. Your room layout or personal preference will dictate which installation location you select. Take into consideration the size and position of your screen, the location of a suitable power outlet, as well as the location and distance between the projector and the rest of your equipment.

### 1. Front Table:

Select this location with the projector placed near the floor in front of the screen. This is the most common way to position the projector for quick setup and portability.

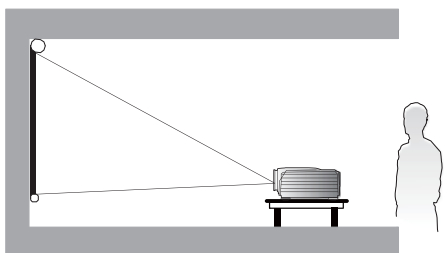

### 3. Rear Table:

Select this location with the projector placed near the floor behind the screen. Note that a special rear projection screen is required.

\*Set Rear Table after you turn the projector on.

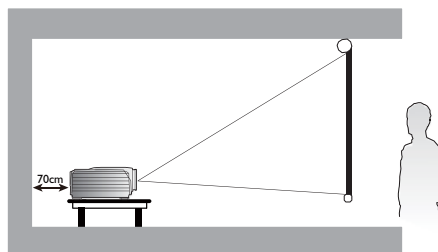

### 2. Front Ceiling:

Select this location with the projector suspended from the ceiling in front of the screen. Purchase the BenQ Projector Ceiling Mount Kit from your dealer to mount your projector on the ceiling.

\*Set Ceiling Front after you turn the projector on.

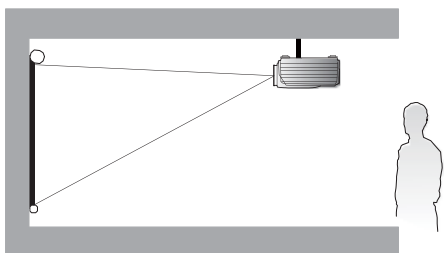

### 4. Rear Ceiling:

Select this location with the projector suspended from the ceiling behind the screen.

Note that a special rear projection screen and the BenQ Projector Ceiling Mount Kit are required for this installation location.

\*Set Ceiling Rear after you turn the projector on.

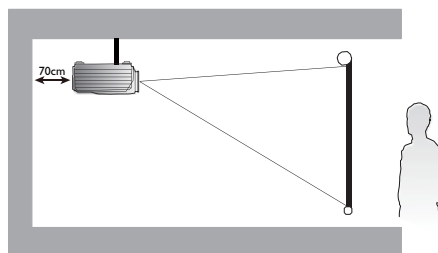

\*To set the projector position:

Press **MENU** and then press ◀/▶ to select **Setup** menu.

Press ▲/▼ to highlight Projector Installation and press ◀/▶ until the correct position is selected.

### Note:

- Ceiling installation must be done by a qualified professional. Contact your dealer for more information. It is not recommended you install the projector by yourself.
- Only use the projector on a solid, level surface. Serious injury and damage can occur if the projector is dropped.
- Do not use the projector in an environment where extreme temperature occurs. The projector must be used at temperatures between 41 degrees Fahrenheit (5 degrees Celsius) and 104 degrees Fahrenheit (40 degrees Celsius).
- Screen damage will occur if the projector is exposed to moisture, dust or smoke.
- Do not cover the vents on the projector. Proper ventilation is required to dissipate heat. Damage to the projector will occur if the vents are covered

# Projection distance and screen size

Example of LU9715 using Standard lens:

The further your projector is from the screen or wall, the larger the image. The minimum size the image can be is approximately 40 inches (1 m) measured diagonally when the projector is roughly 75.8 inches (1.93 m) from the wall or screen. The largest the image can be is 500 inches (12.7 m) when the projector is about 978.3 inches (24.85 m) from the wall or screen.

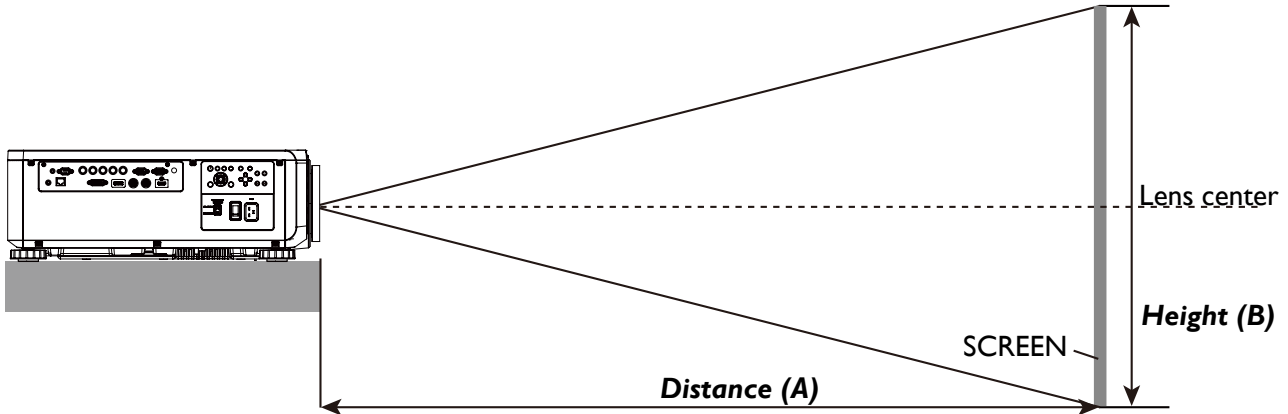

## LU9715

Screen Size						5J,JAM37.01 I		5J,JAM37.02 I				5J,JAM37.00 I				5J,JAM37.05 I							
						Wide Fix Lens		Wide Zoom Lens				STD Lens				Semi long Zoom1							
Diagonal		Width		Height (B)		Distance (A)																	
						N/A		Wide		Tele		Wide		Tele		Wide		Tele					
(inch)	(m)	(inch)	(m)	(inch)	(m)	(inch)	(m)	(inch)	(m)	(inch)	(m)	(inch)	(m)	(inch)	(m)	(inch)	(m)	(inch)	(m)				
40	1.02	34	0.86	21	0.54	25.1	0.64	41.4	1.05	59.9	1.52	57.2	1.45	75.8	1.93	73.6	1.87	124.1	3.15				
50	1.27	42	1.08	26	0.67	31.8	0.81	52.3	1.33	75.4	1.92	72.1	1.83	95.5	2.42	92.9	2.36	155.9	3.96				
60	1.52	51	1.29	32	0.81	38.5	0.98	63.1	1.60	90.9	2.31	87.1	2.21	115.1	2.92	112.1	2.85	187.8	4.77				
80	2.03	68	1.72	42	1.08	52.0	1.32	84.9	2.16	121.8	3.09	117.0	2.97	154.3	3.92	150.5	3.82	251.4	6.39				
100	2.54	85	2.15	53	1.35	65.5	1.66	106.6	2.71	152.7	3.88	147.0	3.73	193.5	4.92	188.9	4.80	315.0	8.00				
120	3.05	102	2.58	64	1.62	78.9	2.01	128.4	3.26	183.6	4.66	176.9	4.49	232.8	5.91	227.6	5.78	378.6	9.62				
150	3.81	127	3.23	79	2.02	99.1	2.52	161.0	4.09	230.0	5.84	221.8	5.63	291.6	7.41	285.0	7.24	474.1	12.04				
180	4.57	153	3.88	95	2.42	119.3	3.03	193.6	4.92	276.4	7.02	266.7	6.77	350.5	8.90	342.6	8.70	569.5	14.47				
200	5.08	170	4.31	106	2.69	132.8	3.37	215.3	5.47	307.3	7.81	296.6	7.53	389.7	9.90	381.0	9.68	633.1	16.08				
300	7.62	254	6.46	159	4.04	200.1	5.08	324.0	8.23	461.9	11.73	446.3	11.34	585.9	14.9	573.2	14.56	951.2	24.16				
400	10.16	339	8.62	212	5.38	267.4	6.79	432.7	10.99	616.6	15.66	595.9	15.14	782.3	19.87	765.3	19.44	1269.7	32.25				
500	12.70	424	10.77	265	6.73	334.8	8.50	541.5	13.75	771.2	19.59	745.6	18.94	978.3	24.85	957.4	24.32	1587.8	40.33				

Screen Size						5J,JAM37.03 I				5J,JAM37.04 I				5J,JAM37.06 I			
						Long Zoom 1 Lens				Long zoom 2 Lens				Ultra Wide zoom Lens			
Diagonal		Width (C)		Height (B)		Distance (A)											
						Wide		Tele		Wide		Tele		Wide		Tele	
(inch)	(m)	(inch)	(m)	(inch)	(m)	(inch)	(m)	(inch)	(m)	(inch)	(m)	(inch)	(m)	(inch)	(m)	(inch)	(m)
40	1.02	34	0.86	21	0.54	118.7	3.01	181.0	4.60	173.9	4.42	277.7	7.05	24.5	0.62	31.1	0.79
50	1.27	42	1.08	26	0.67	149.7	3.80	227.6	5.78	220.2	5.59	350.0	8.89	31.1	0.79	39.2	1.00
60	1.52	51	1.29	32	0.81	180.7	4.59	274.1	6.96	266.6	6.77	422.3	10.73	37.6	0.96	47.4	1.20
80	2.03	68	1.72	42	1.08	242.7	6.16	367.3	9.33	359.4	9.13	567.0	14.40	50.8	1.29	63.8	1.62
100	2.54	85	2.15	53	1.35	304.3	7.73	460.4	11.70	452.1	11.48	711.6	18.07	63.9	1.62	80.2	2.04
120	3.05	102	2.58	64	1.62	366.7	9.31	553.6	14.06	544.9	13.84	856.2	21.75	77.1	1.96	96.6	2.45
150	3.81	127	3.23	79	2.02	459.4	11.67	693.3	17.61	684.0	17.37	1073.1	27.26	96.8	2.46	121.1	3.08
180	4.57	153	3.88	95	2.42	552.4	14.03	833.0	21.16	823.1	20.91	1290.1	32.77	116.5	2.96	145.7	3.70
200	5.08	170	4.31	106	2.69	614.7	15.6	926.4	23.53	915.9	23.26	1434.7	36.44	129.7	3.29	162.1	4.12
300	7.62	254	6.46	159	4.04	924.0	23.47	1392.1	35.36	1379.6	35.04	2157.8	54.81	195.4	4.96	244.0	6.20
400	10.16	339	8.62	212	5.38	1233.9	31.34	1857.9	47.19	1843.3	46.82	2880.9	73.18	261.2	6.63	325.9	8.28
500	12.70	424	10.77	265	6.73	1543.7	39.21	2323.6	59.02	2307.1	58.60	3604.0	91.54	326.9	8.30	407.7	10.36



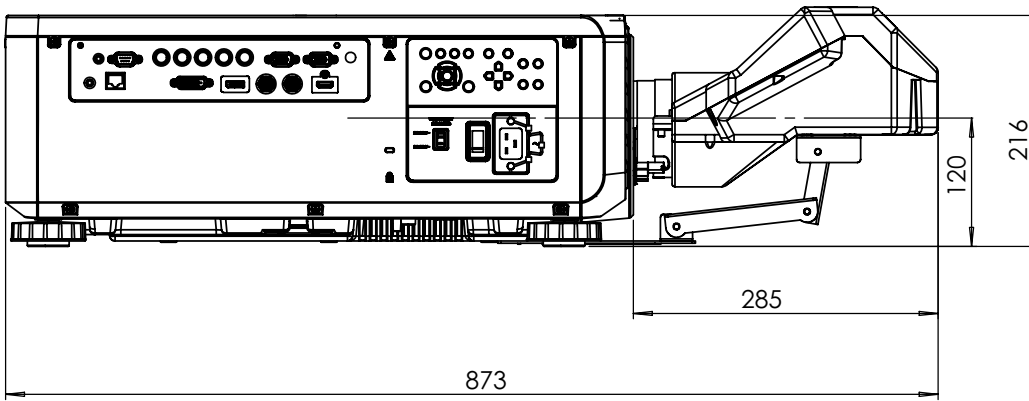

Screen size						5JCY37.002									
						Ultra Short Reflection									
Diagonal		Width		Hight		H1		H2		L1		L2		L3	
inch	mm	inch	mm	inch	mm	inch	mm	inch	mm	inch	mm	inch	mm	inch	mm
100	2540	85	2166	53	1355	19	485	28	701	33	849	22	564	-1	-24
120	3048	102	2599	64	1627	23	596	32	812	39	1000	28	715	5	127
150	3810	128	3247	80	2032	30	763	39	979	48	1227	37	942	14	354
200	5080	170	4330	107	2711	41	1041	49	1257	63	1606	52	1321	29	733
250	6350	213	5415	133	3391	52	1320	60	1536	78	1984	67	1699	44	1111
300	7620	256	6500	160	4071	63	1598	71	1814	93	2362	82	2077	59	1489
350	8890	299	7585	187	4752	74	1877	82	2093	108	2741	97	2456	74	1868

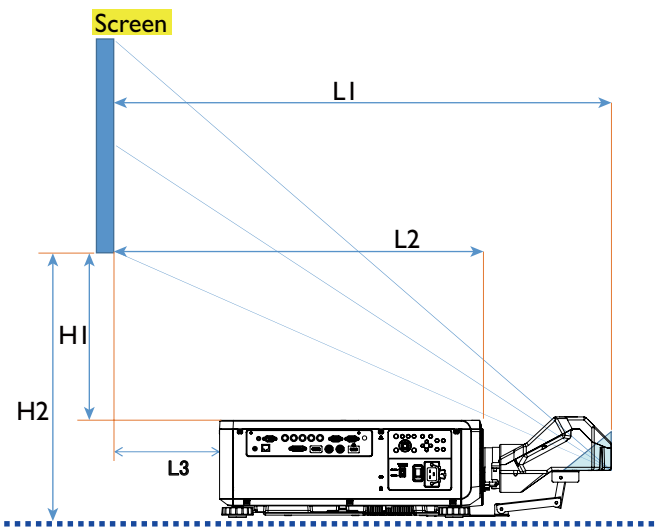

- L1: Screen to the point of mirror
- L2: Screen to projector front
- L3: Screen to project back
- H1: Screen bottom to projector top side
- H2: Screen bottom to projector bottom

# Lens shift adjustable range

The adjustable range for lens shift is tabulated below and subject to the conditions listed.



## Note:

The drawings below apply to the standard lens only.

### Desk-Front Projection

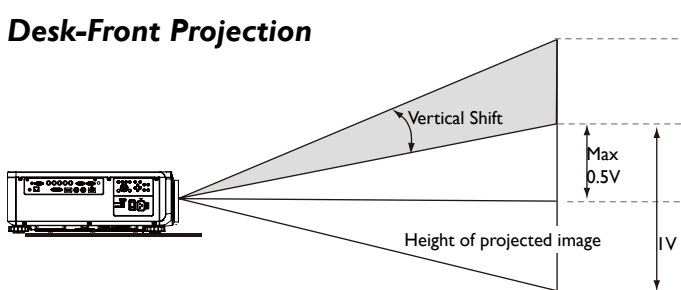

### Ceiling Mount-Front Projection

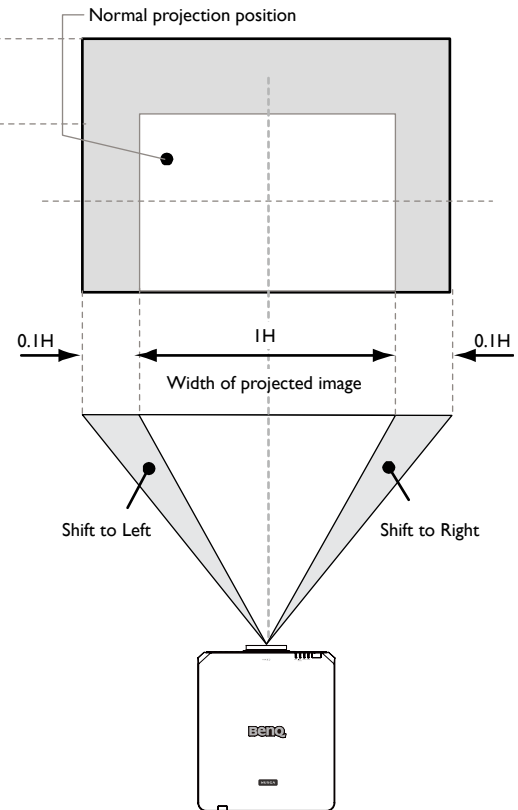
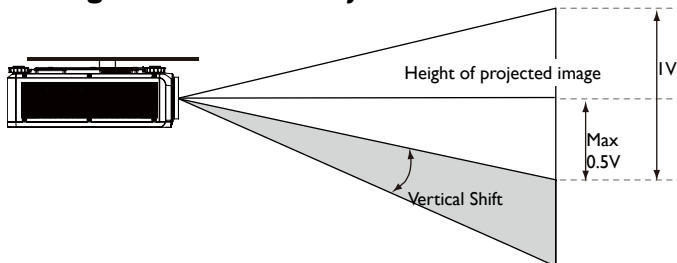

# Making connections

## Preparations

When connecting a signal source to the projector, be sure to:

1. Turn off all equipment before making any connections.
2. Only use the correct type cables for each source with proper type plugs.
3. Ensure that all cable plugs are firmly fitted to the equipment jacks.

Note that all cables shown in the following connection diagrams may not be supplied with the projector (See "Shipping contents" on page 14 Shipping contents). Most cables are commercially available from electronics stores.

## Connect to PC

You may connect a PC to your projector with a DVI-D, HDMI, RGB or RGBHV (BNC) cable for projection, and connect an external display to your projector for concurrent viewing if the input is RGB signal.

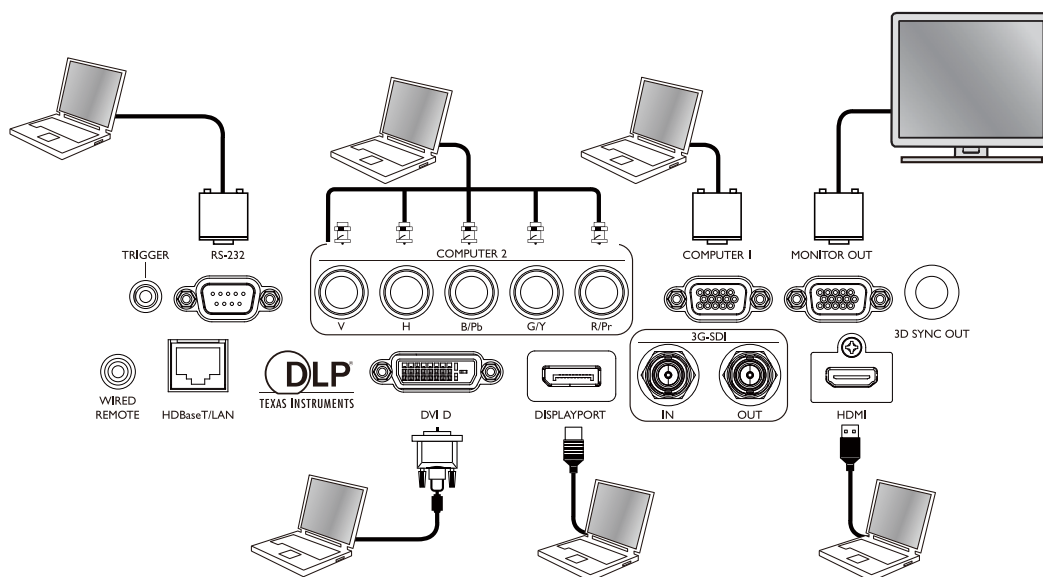

## Connect to video equipment

You may connect any video equipment to your projector's input port with a DVI-D, HDMI, DisplayPort or YPBPR cable.

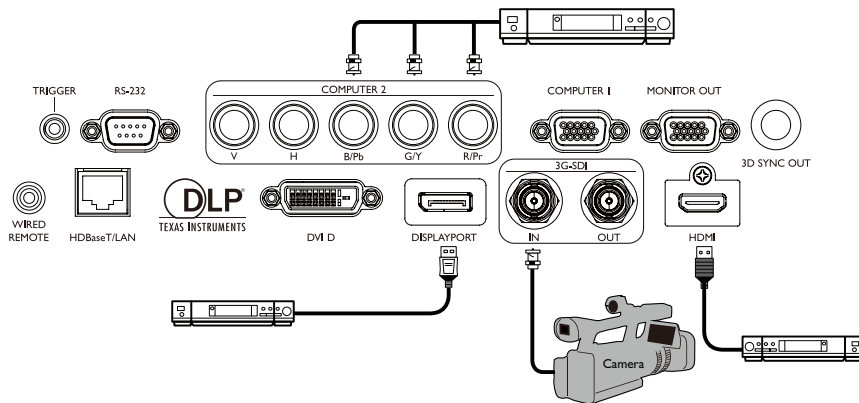

## Connect to control port

Your projector features the following control ports:

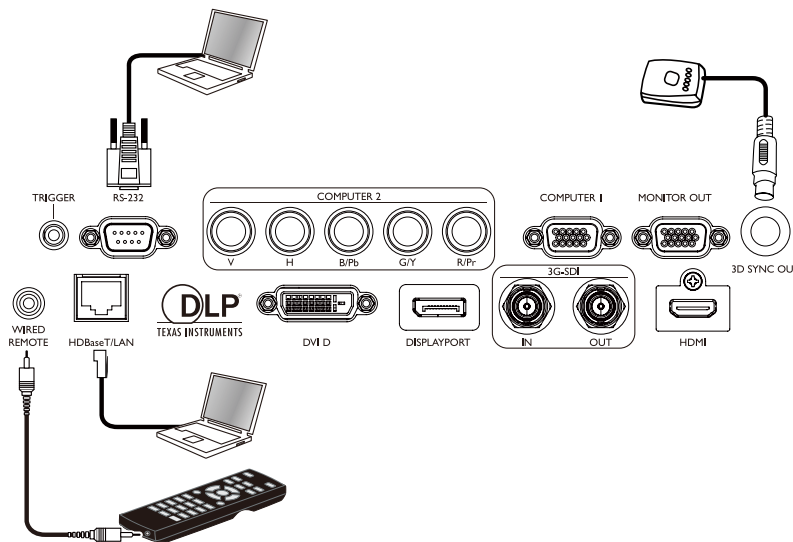

- **HDBaseT/LAN**

Your projector supports network control with shared LAN (network control) and HDBaseT.

- **RS-232 (RS-232c control)**

Your projector supports RS-232c serial control, you may connect the projector to a PC with standard 9-pin serial cable (straight through wire) for remote control.

- **Wired controller**

If the remote controller's IR signal fails to reach your projector because the two are too far apart or blocked by any obstacle, you may connect the WIRED input port of your projector to an IR remote controller or an (optional) IR repeater to expand its working area.

- **3D Sync Out**

3D IR sync signal transmitter.

## Caution:

- The projector enters wired control mode automatically and cannot be controlled by a remote controller's IR signal once the terminal of a remote controller is inserted in the projector's wire port. To control your projector with the IR signal of a remote controller again, remove the wire control terminal from the projector.
- Make sure the port is valid before inserting a wired remote controller. The remote controller may be damaged if a port is invalid, e.g. a wired remote controller is connected to trigger output.

## Connect to screen trigger

You may connect a projector screen or other 12V trigger device to the projector and turn on trigger output in OSD Control->Trigger. The trigger port supply the 12V signal after the projector is powered on. After the projector is powered on it outputs 12V signal which adheres to current aspect ratio and screen control settings for projector screen control.

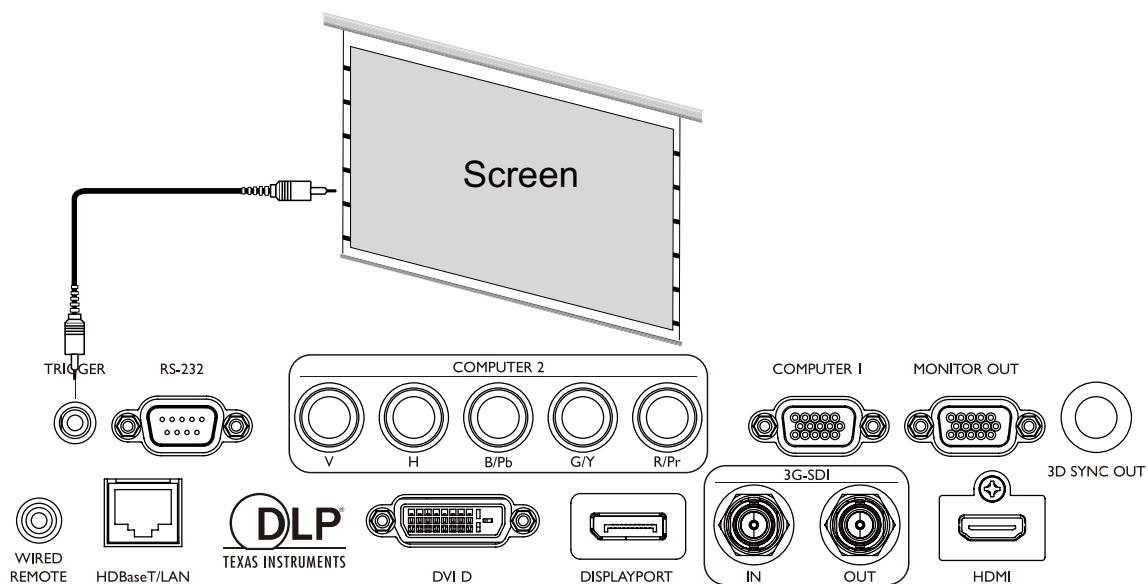

## Connect to external digital transmitter

The projector features a built-in HDBaseT for you to work with optional digital transmitter to send video, RS-232, LAN signal to projector with single RJ-45 cable. If the optional digital transmitter supports IR remote controller I/O, you may also send IR remote controller signal to LU9715 projector using the same RJ-45 cable.

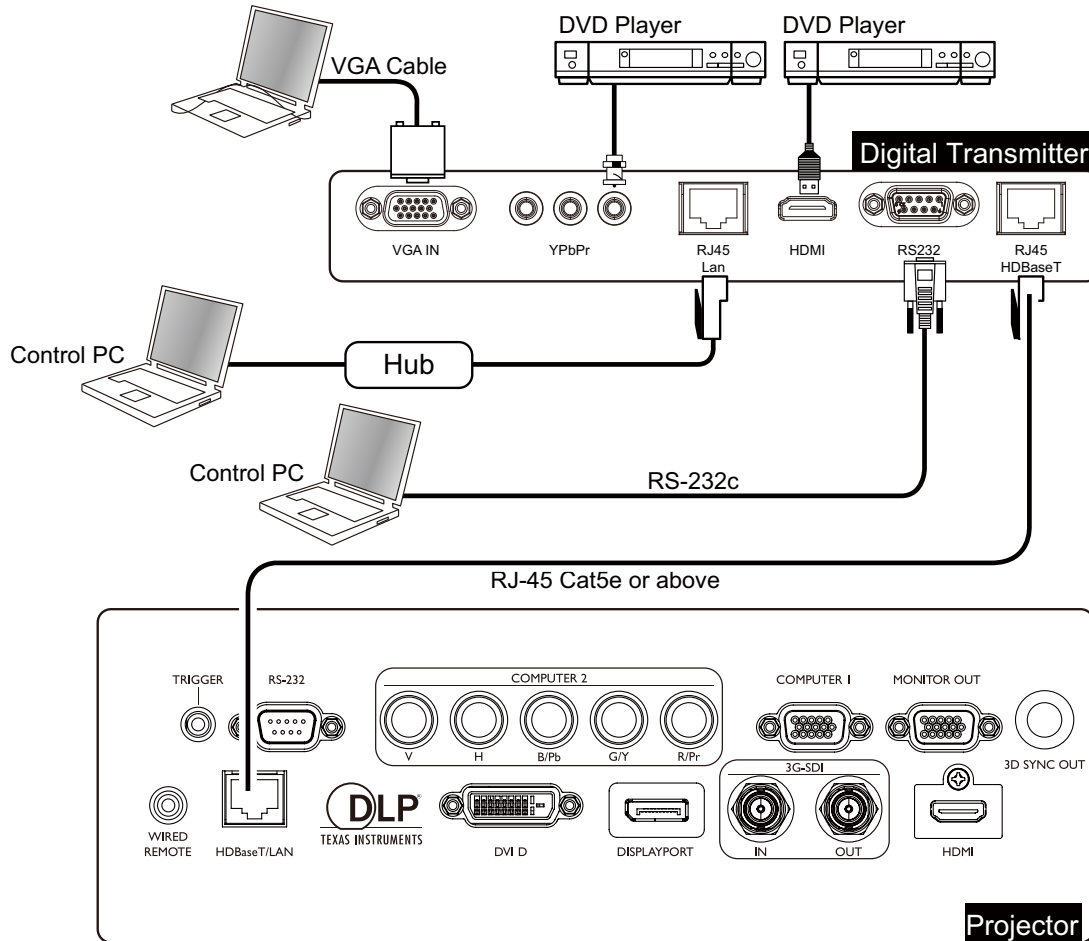

### Caution:

- The HDBaseT of your projector supports to video, RS-232, remote controller, and network control signal receiving but not Power over Ethernet (PoE) transmission and receiving.
- Effective transmission distance of your digital transmitter is 100 meters. Transmission over 100 meters may lead to projection screen interruption, interference, or control signal failure.
- Please use Cat.5e RJ-45 cable or better and prevent the cable from becoming twisted. Otherwise the cable may be damaged and signal transmission quality poor, reducing transmission distance and image quality.

# Using the projector

## Preparations

1. Plug in and turn all of the connected equipment on.
2. Insert the projection lens.
3. Plug the power cable into a wall power outlet, check the voltage switch placed at right voltage in the region being used, and turn on AC switch.

### Note:

Please use the original accessories (e.g. power cable) only with the device to avoid possible dangers such as electric shock and fire.

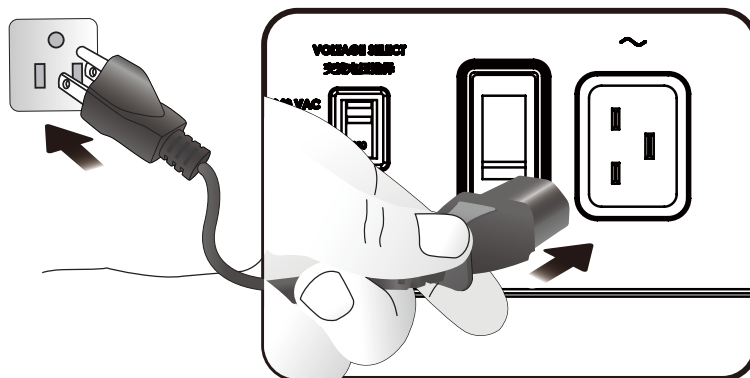

Please make sure the Voltage Switch is selected at the right voltage in the region where projector is being used, before you turn on the power switch.

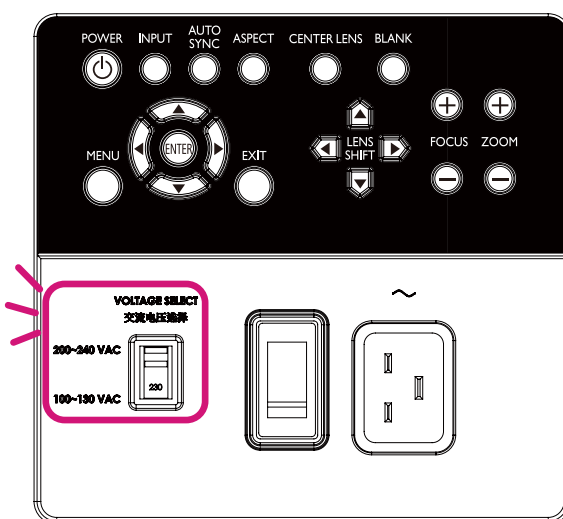

## Turning the projector on or off

Once the projector is correctly located and the power cable and other connections are in place, it is important that the projector is connected and powered on correctly in order to avoid possible dangers such as electric shock and fire. Refer to the following guide to power on the projector.

1. Turn on the AC power switch. POWER LED is red after power has been applied.
2. Press the POWER button on the projector or ON button on the remote control to start the projector. The Power and Light source LED flashes green and the cooling fan start operating.
3. The projected image will be displayed on the screen for a few second while it is warming up.
4. Once the power LED is lit a solid green, the projector is ready for use.  
Note: The projector will not respond to further commands while it is warming up.
5. If any of the LEDs remain flashing or blink there may be a problem with the start up. Please refer to the page 81 Troubleshooting.

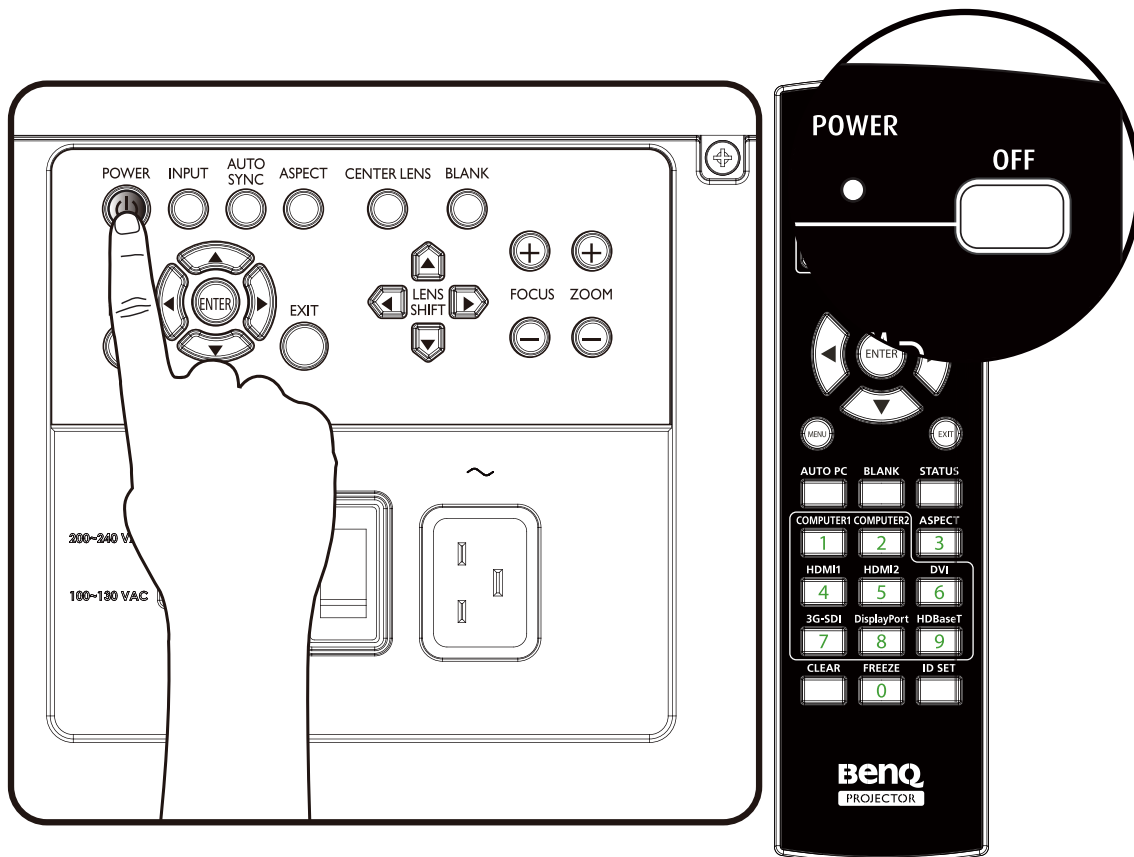



## Selecting an input source

The projector can be connected to multiple equipment at the same time. When the projector is first turned on, it will attempt to reconnect with the input source which was in use when the projector was last shut down.

The Input Source can be selected from the projector's control panel or from the remote control. Refer to the following guide to select the desired input source.

1. Press INPUT key on the control panel or use remote controller to select your desired input source.

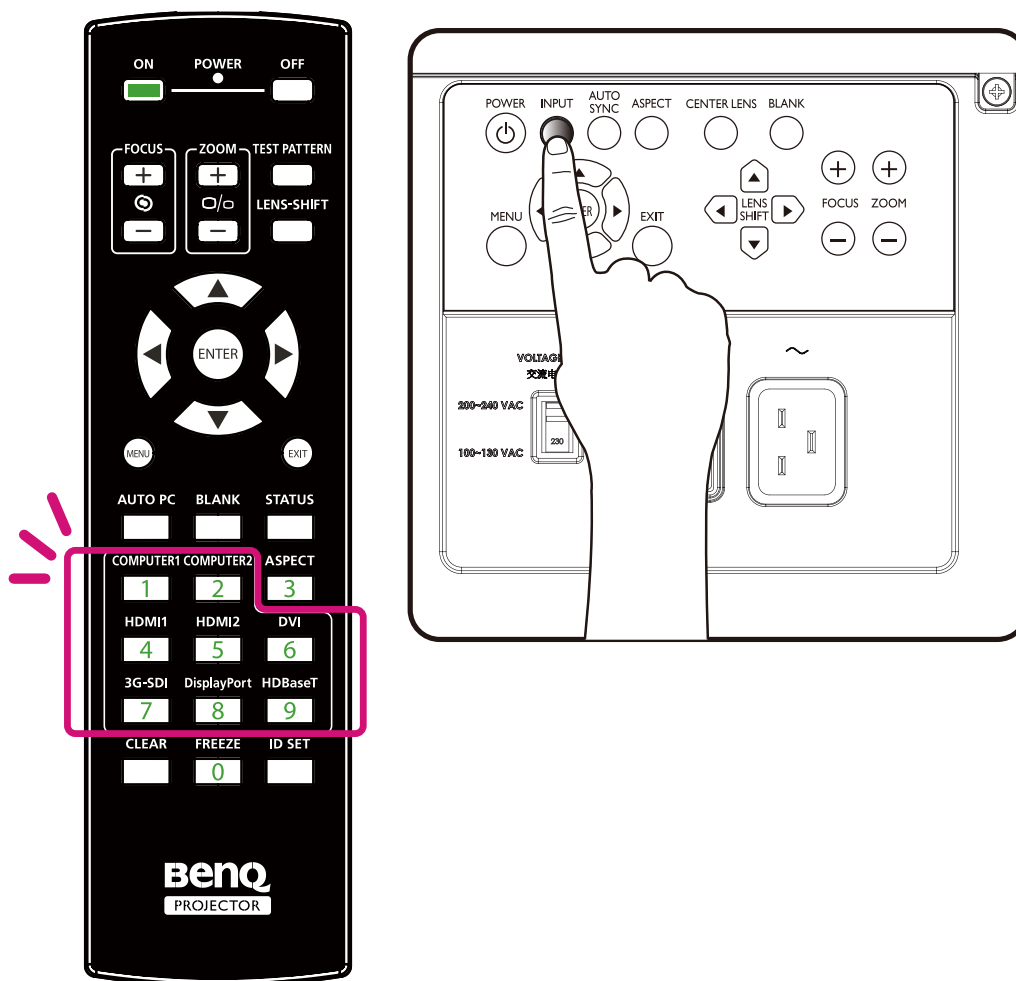

2. Press ENTER key to confirm the input selection, it will take few seconds to detect the desired input signal and display the projected image.  
Press EXIT key to projected image if you want to keep current input source.

## Using the menus

The projector is equipped with multilingual On-Screen Display (OSD) for making various adjustment and settings. The introduction below is the overview of the OSD menu.

To use the OSD menu, please set the OSD menu to your familiar language.

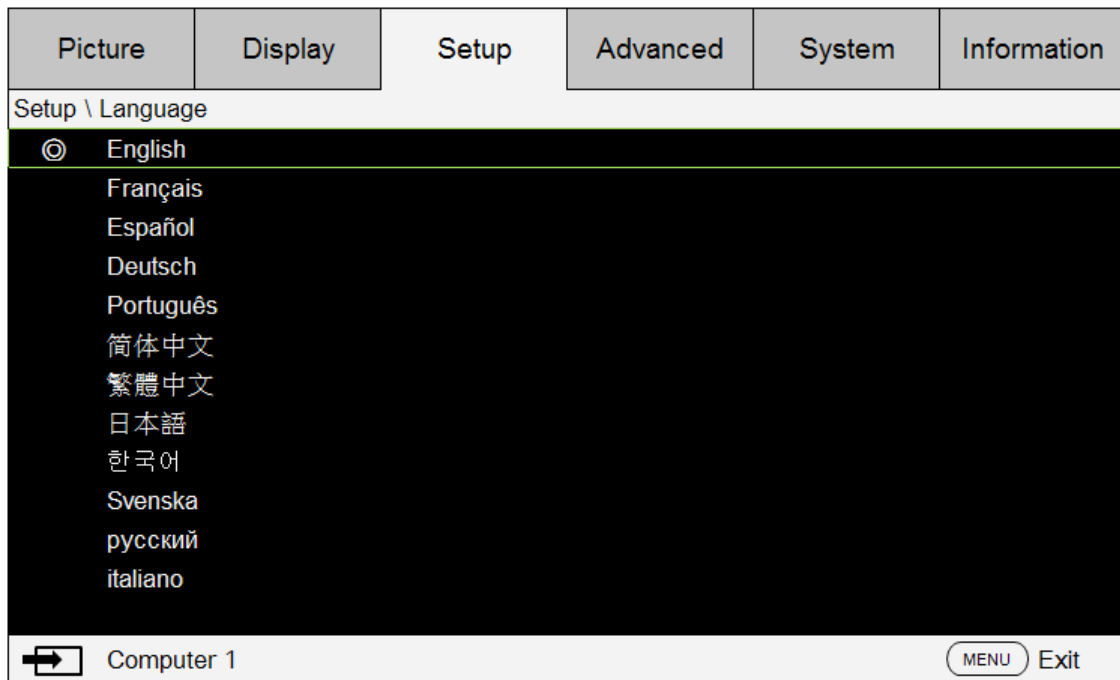

## Adjusting the image position

The projected image position and size can be adjusted manually from the control panel or the remote control unit. Refer to the following guides to adjust Picture Position manually.

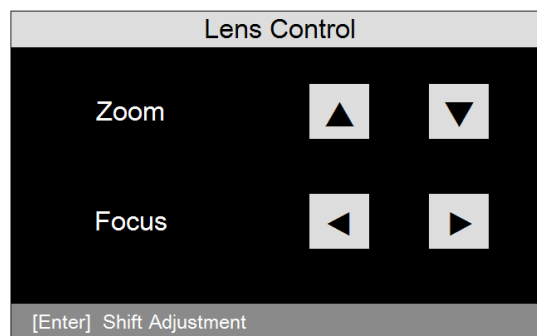

1. Press the LENS SHIFT key on the projector in any direction or LENS SHIFT key on the remote control to bring up the Lens Shift window.
2. Press the directional key as required to shift the image.

## Fine-tuning the image size and clarity

1. Press the ZOOM + or ZOOM- button on the control panel or the remote control to adjust the projected image as you desired.
2. Sharpen the picture by pressing FOCUS+ or FOCUS- button on the control panel or the remote control.

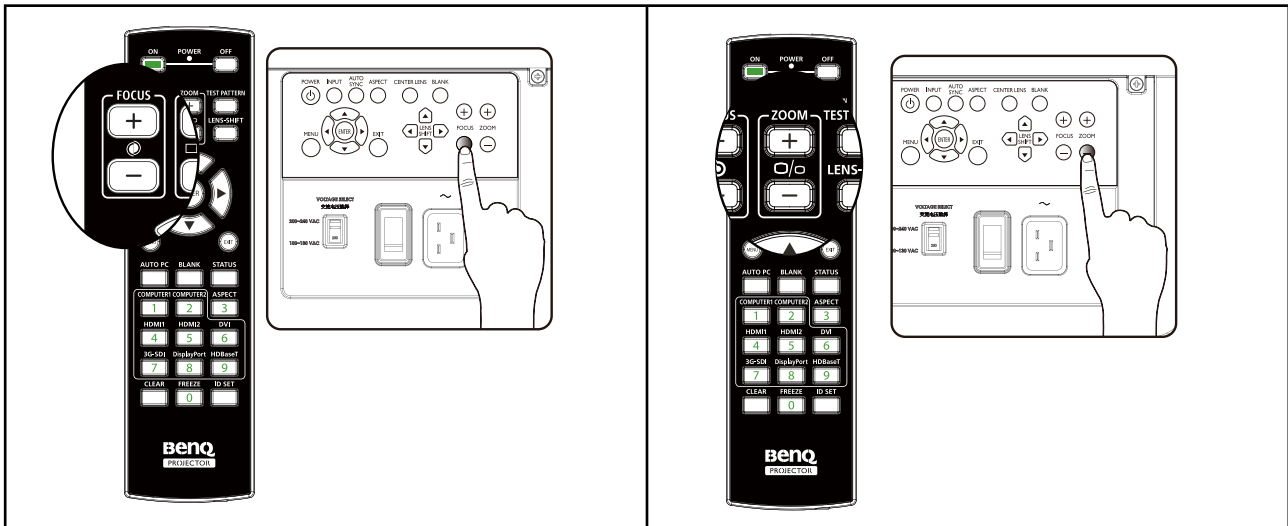

## Adjusting the projection angle

There are four adjuster feet on the bottom of the projector, these can be used if it is necessary to change the projection angle. Screw the feet in or out as appropriate to aim and level the projection angle.

1. Twist the adjusters clockwise to raise the level of the projector.
2. To lower the level of the projector, lift the projector and twist the adjusters counter clockwise.

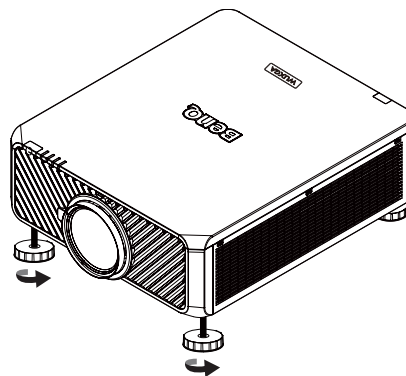
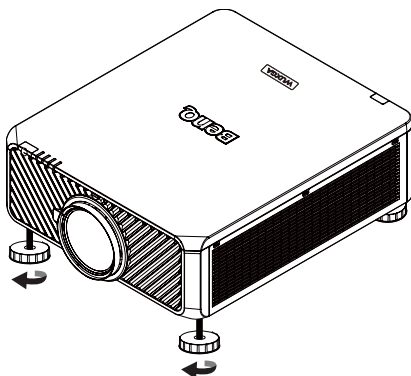

### Note

Adjusting foot will be disassembled after lower the foot more than 4 cm.

## Correcting picture distortion

When the image is projected either from the top or from the bottom towards the screen at angle, the image becomes distorted trapezoid. Keystone function in the Display > Keystone can be used to correct distortion or ◀ ▶ to correct vertical distortion, till you are satisfied with the shape.



When the values reach their maximum or minimum with repeated key presses, the picture's shape will stop changing. You will not be able to change the picture further in that direction.

## Auto-adjusting the image

In some cases, you may need to optimize the RGB picture quality. To do this, press AUTO PC key on remote control or AUTO SYNC on panel, the built-in Intelligent Auto Adjustment function will re-adjust the values of Frequency and Clock to provide the best picture quality.

### **Note:**

This function is only available when a PC signal (analog RGB) is selected.

## Turning off the projector

If the projector is no longer required, it is important to shut it down correctly to avoid damage or unnecessary wear and tear to the projector. Refer to the following guide to turn the projector Off.

- Do not unplug the power cable from the wall outlet or projector when the projector is powered on, it may cause damage to the AC IN connector of the projector and (or) the prong plug of the power cable.
  - Do not turn off the AC power supply while making adjustment or setting changes and closing the menu, it may cause loss of adjustments and settings and return to default.
1. Press the **POWER** button on the control panel or **OFF** button on the remote control.

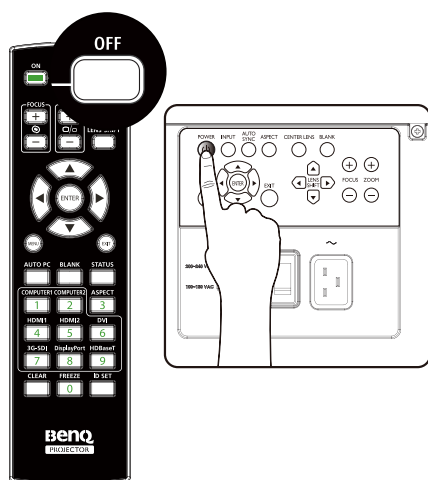

2. Press the **POWER** or **OFF** button again to confirm power off. The power LED flashes orange during cooling stage; the power LED flashes solid red when projector returns to standby mode.

 **Power Off?**  
Press Power again

3. Press the AC switch to the off position (O) to turn off the main power supply without LED indication.

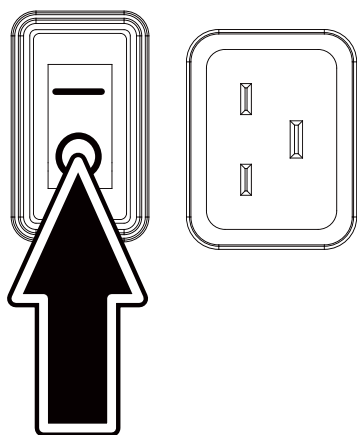

# Using On-Screen Display

## Using the Menus

The projector has an On-Screen Display (OSD) that lets you make image adjustments and change various settings.

## Navigating the OSD

You can use the remote control or the buttons on the top of the projector to navigate and make changes to the OSD. The following illustration shows the corresponding buttons.

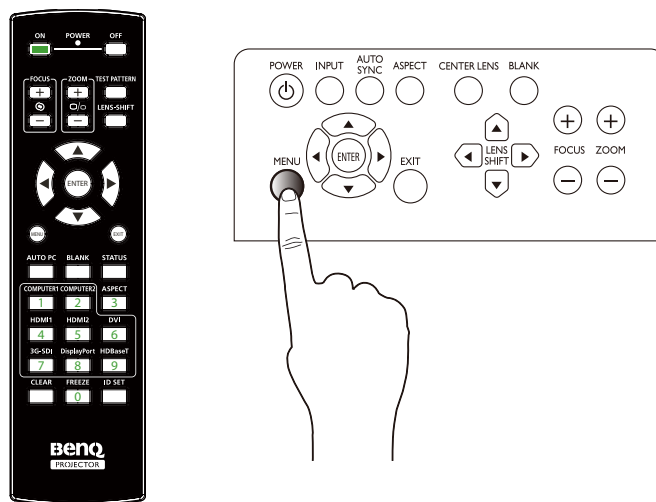

1. To open the OSD, press the Menu button on control panel or remote control. There are six folders on the menu. Press the cursor ◀ or ▶ buttons to move through secondary menus.
2. Press ▲ or ▼ to select menu items and ◀ or ▶ to change values for settings. Press up or down, Press Enter to confirm the new setting.

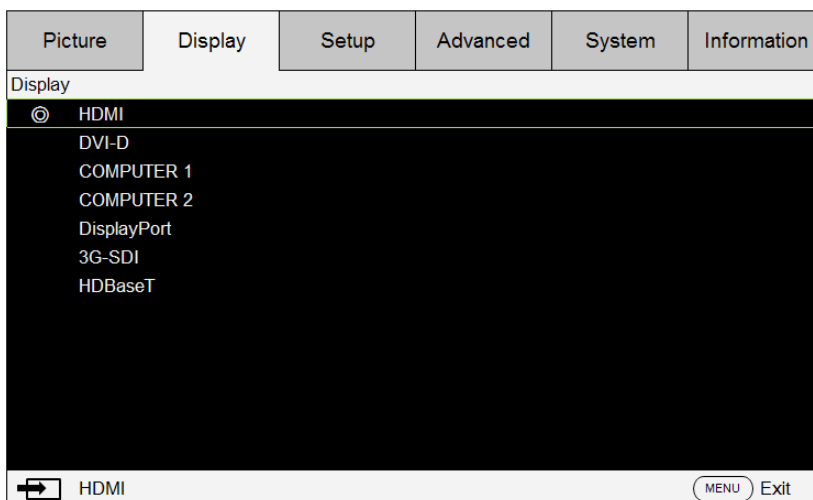

3. Press EXIT or MENU to leave a submenu or MENU to close menu.

## On-Screen Display (OSD) menus

Use the following illustrations to quickly find a setting or determine the range for a setting.

Please note that the on-screen display (OSD) menus vary according to the signal type selected.

Main menu	Sub-menu		
Picture	Picture Mode	Bright	
		Presentation	
		Cinema	
	Brightness	0 ~ 200	
		Contrast	0 ~ 200
		Saturation	0 ~ 200
		Hue	0 ~ 200
		Gamma	1.0
			1.8
	2.0		
	2.2		
	2.35		
	Color	Color Temperature	2.5
			Native
			5400K
			6500K
			7500K
		Color Adjustment	9300K
			Red Offset
			Green offset
			Blue Offset
			Red Gain
			Green Gain
Blue Gain			
Reset Color Adjustment			
Hue		Red	
		Green	
		Blue	
		Cyan	
	Magenta		
Saturation	Yellow		
	Reset Hue		
	Red		
	Green		
	Blue		
	Cyan		
Gain	Magenta		
	Yellow		
	Reset Saturation		
	Red		
	Green		

Main menu	Sub-menu		
Picture	Color	Gain	Blue
			Cyan
			Magenta
			Yellow
			Reset Gain
		White Balance	Red
			Green
			Blue
			Reset White Balance
			Execute
	Sharpness	Reset Color	
Noise Reduction	Off		
Overscan	Crop		
Reset Picture	Zoom		
Reset Picture	Execute	Reset Picture	
		Yes	
		No	

Main menu	Sub-menu			
Display	Source	HDMI		
		DVI-D		
		COMPUTER1		
		COMPUTER2		
		Display Port		
		3G-SDI		
		HDBaseT		
		Aspect Ratio	5:4	
			4:3	
			16:10	
			16:09	
			1.88	
			2.35	
			Theaterscope	
	Keystone	Source		
		Unscaled		
		Test Pattern		
		H keystone	Horizontal -600 - 600	
		V keystone	Vertical -400 - 400	
		Rotation	-10 ~ 10 (0.25 degree /step)	
	Rotation	Reset	Execute	
		Rotation	- 100 ~ 100 (0.25 degree /step)	
	Pincushion / Barrel	H Pin/Barrel	Reset	Execute
			H and V adjustment, -150 (Pincushion) <= ( H,V ) <= 300 (Barrel)	
		V Pin/Barrel	H and V adjustment, -150 (Pincushion) <= ( H,V ) <= 300 (Barrel)	



Main menu	Sub-menu			
Display	Keystone	H keystone		
		V keystone		
		Rotation		
		Execute		
		Four Corner	Reset	
	Four Corner	Test Pattern		
		Top Left	192 <X<-192 , 120 <Y<-120	
		Top Right	192 <X<-192 , 120 <Y<-120	
		Bottom Left	192 <X<-192 , 120 <Y<-120	
		Bottom Right	192 <X<-192 , 120 <Y<-120	
		Reset Corner Fit	Execute	
	PIP	PIP	ON	
			OFF	
	Source	Source	HDMI	
			DVI-D	
			COMPUTER1	
			COMPUTER2	
			Display Port	
			3G-SDI	
			HDBaseT	
			Position	TopLeft
				TopRight
				BottomLeft
				Bottom Right
	Position and Phase	V Position	PBP	
			0 ~ 200	
			H Position	0 ~ 200
Phase			0 ~ 200	
Tracking			0 ~ 200	
Sync Level			0 ~ 200	
3D	3D Format	OFF		
		Auto		
		Side by Side (Half)		
		Top and Bottom		
		Frame Sequential		
		DLP Link	Off	
			On	
		3D Swap	3D Swap	Normal
				Reverse
		Color Space	Auto	YCbPr
YCbCr				
RGB-PC				
RGB-Video				
Reset Display	Execute			
Reset Display	Reset Display	Yes		
		No		

Main menu	Sub-menu			
Setup	Language	English		
		French		
		Spanish		
		German		
		Italian		
		Swedish		
		Portuguese		
		Russian		
		Korean		
		Japanese		
		繁體中文		
		簡體中文		
		Projector Installation	Front Table	
			Rear Table	
Front Ceiling				
Rear Ceiling				
Auto Source Search	On			
	Off			
Lens Control	( Zoom & Focus )			
Lens Memory	Load Memory	Memory 1		
		Memory 2		
		Memory 3		
		Memory 4		
		Memory 5		
		Memory 6		
		Memory 7		
		Memory 8		
		Memory 9		
		Memory 10		
	Save Memory	Memory 1		
		Memory 2		
		Memory 3		
		Memory 4		
Clear Memory	Memory 5			
	Memory 6			
	Memory 7			
	Memory 8			
	Memory 9			
	Memory 10			
	Memory 1			
	Memory 2			

Main menu		Sub-menu	
Setup		Clear Memory	Memory 9 Memory 10
	Center Lens	Execute	
	Digital Zoom	Digital Zoom	0% ~ 100%
		Digital Pan	0 ~ 100
		Digital Scan	0 ~ 100
		RESET	(OK) to execute
	Light Settings	Light Mode	Eco Normal Custom
		Light Power	20%~100%
		High Altitude	On Auto
	Test Pattern	Off White Black Red Green Blue Checkerboard CrossHatch V Burst H Burst ColorBar	
	Test Pattern	Plunge	
	Reset Setup	Execute	Reset Setup Yes No

Main menu		Sub-menu	
Advanced	Blanking	Top	0 ~ 360
		Bottom	0 ~ 360
		Left	0 ~ 534
		Right	0 ~ 534
		Reset Blanking	Execute
	Edge Blending	Status	Off / On
		Adjust Lines	Off / On
		White Level	Top      0, 100 ~ 500 Bottom    0, 100 ~ 500 Left       0, 100 ~ 800 Right      0, 100 ~ 800
		Black Level	Top        0 ~ 32 Bottom     0 ~ 32 Left        0 ~ 32 Right       0 ~ 32 All          0 ~ 255 Red         0 ~ 255 Green       0 ~ 255

Main menu	Sub-menu		
Advanced		Blue	0 ~ 255
	Reset Edge Blending	Execute	Reset Edge Blending Yes No

Main menu	Sub-menu		
System	Standby Mode	Network	
		Eco	
	Auto Power Off	On	
		Off	
	Direct Power on	On	
		Off	
	Network	IP Address	192.168.00.100
		Subnet mask	255.255.255.0
		Gateway	192.168.00.254
		DHCP	On Off
		Apply	Execute      Apply OK Cancel
		Reset Network	Execute      Reset Network Yes No
	Background	Logo	
		Blue	
		Black	
		White	
	Startup Logo	On	
		Off	
	Trigger	On	
		Off	
	Dynamic Black	On	
		Off	
	Reset System	Execute	Reset System Yes No

Main menu	Sub-menu	
Information	Model	BenQ Projector
	Serial Number	W332AFHCY001
	Software Version	MP05-0D06-....
	Active Source	VGA
	Pixel Clock	13.50 MHZ
	Signal Format	NTSC
	H/V Refresh Rate	H: 15.736 KHZ V: 60 HZ
	Light Source Usage	
	Thermal Status	Inlet 1/2 Temp.
Information	Thermal Status	DMD Temp.

Main menu	Sub-menu	
	Laser 1/2 Temp.	
	Outside Temp..	
	FAN Speed	
Reset to Default Setting	Execute	Reset All
		Yes
		No

## OSD menu - Picture

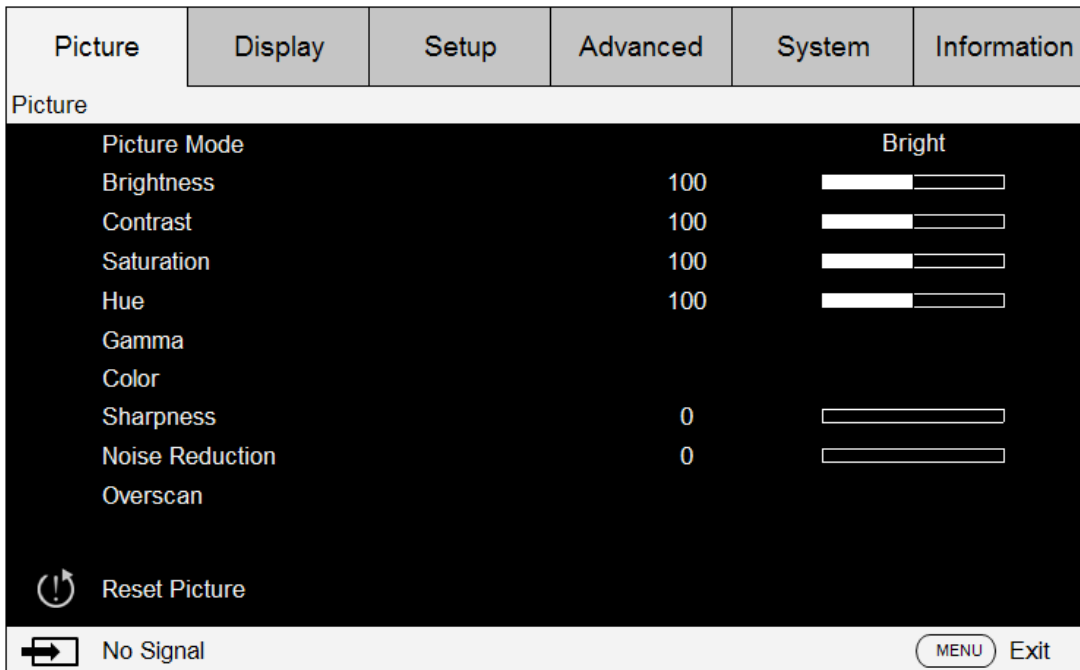

- **Picture Mode**

Press ◀▶ arrow key to select display mode.

**Bright:** Output in the highest brightness for application that requires higher brightness.

**Presentation:** Display the best image effect for presentation or static image projection.

**Cinema:** Display in best color effect for film playback.

- **Brightness**

Press ◀▶ arrow keys to adjust image brightness.

- **Contrast**

Press ◀▶ arrow keys to adjust image contrast.



### Caution:

Brightness and contrast are two mutually dependent factors. To achieve optimized settings you may have to fine tune brightness settings after contrast adjustment.

- **Saturation**

Press ◀▶ arrow keys to adjust saturation level. (The higher the level the more saturated the color.)

- **Hue**

Press ◀▶ arrow keys to adjust hue level of color.

- **Gamma**

Press ◀▶ arrow keys to adjust 1.0, 1.8, 2.0, 2.2, 2.35 and 2.5 level.

- **Color**

Press ◀▶ arrow keys to adjust color temperature of image.

**Color Temperature:** You can choose from 5400K, 6500K, 7500K, 9300K and Native. The projector's default color temperature is set at NATIVE and it is suitable for most situations.

**Color Adjustment:** This function allows users to adjust Gain and offset for Red, Green, and Blue independently.

**Hue:** Press ENTER to enter the Hue menu. Press ◀▶ to adjust settings of red, green, blue, cyan, magenta, and yellow.

**Saturation:** Press ENTER to enter the Saturation menu. Press ◀▶ to adjust settings of red, green, blue, cyan, magenta, and yellow.

**Gain:** Press ENTER to enter the Gain menu. Press ◀▶ to adjust settings of red, green, blue, cyan, magenta, and yellow.

**White Balance:** Press ENTER to enter the White Gain menu. Press ◀▶ to adjust settings of red, green, and blue.

- **Sharpness**

Press ENTER, and use ◀▶ to adjust the sharpness, which changes the high-frequency details.

- **Noise Reduction**

Press ◀▶ arrow key to adjust noise of projection image. This function helps eliminating image noise caused by interlaced scanning input. In general, image noise reduction decreases value of high frequency details and makes the image looking smoother.

- **Overscan**

Input source may be not an image with 16:10 ratio and there may be noise at image margin. Select one of the three options to hide image margin.

## OSD menu - Display

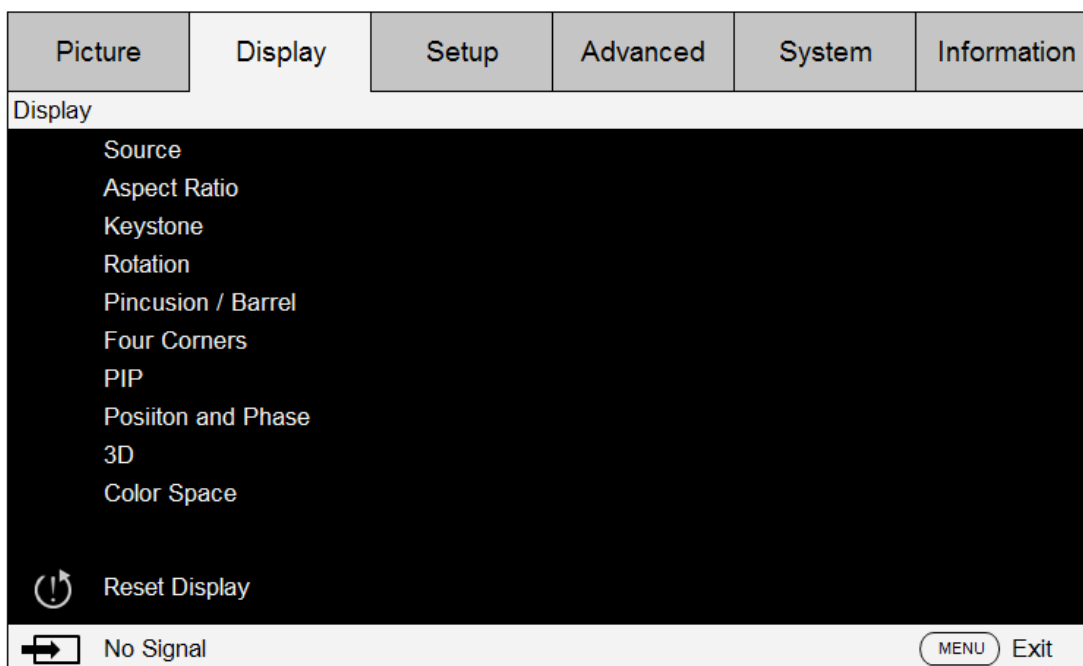

- **Source**

This functions is the same as the Hotkey on your remote controller. You can select the desired input source with the remote controller or this function.

**HDMI**

This is the terminal to input HDMI signals from PC or media device.

**DVI-D**

This is the terminal to input DVI-D signals from PC.

**Computer 1**

This is the terminal to input RGB signals from PC.

**Computer 2**

This is the terminal to input YCbCr/YPbPr or RGB singals(RGBHV) from PC or media device.

**DisplayPort**

This is the terminal to input DisplayPort signal from PC or media device.

**3G-SDI**

This is the terminal to input uncompressed digital video from media device.

### HDBaseT

This is the terminal to input uncompressed high-definition video (HD) via RJ-45 cable.

- **Aspect Ratio**

Use this option to adjust aspect ratio.

For normal input of 16:10 the aspect ratio will look like the following images:

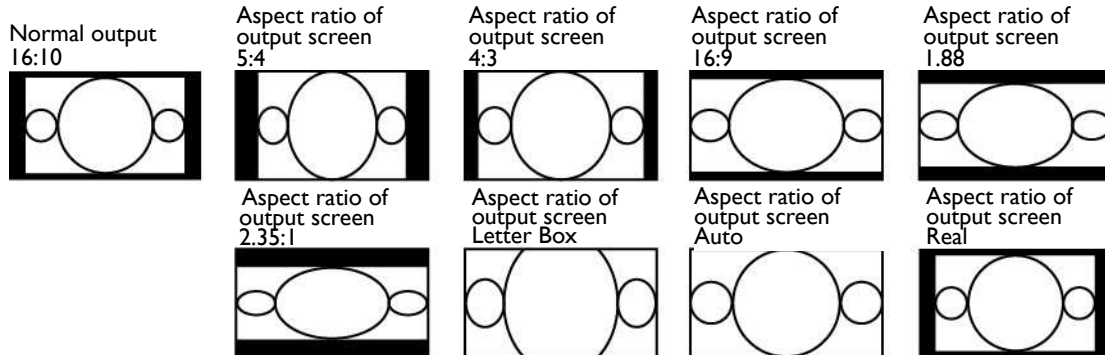

For normal input of ratio 4:3, the aspect ratio will look like the following images:

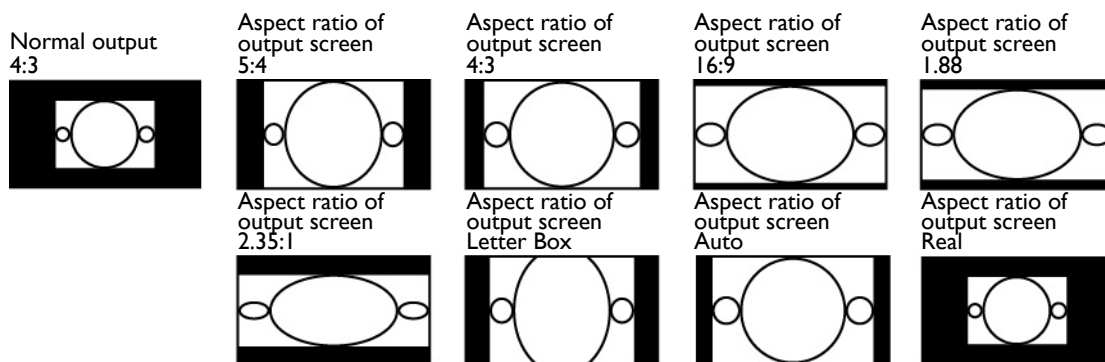

- **Keystone**

Select this function and press ◀▶ arrow keys to correct vertical deformation caused by projection angle.

- **Rotation**

Press ◀▶ button to rotate the image to desirable position.

- **Pincushion / Barrel**

Press ◀▶ button to correct pincushion/barrel distortion.

- **Four Corner**

Under Four Corner, a grid test pattern can be displayed to make sure the adjust change.

Top Left: Press ◀▶ buttons to correct distortion at top left corner

Top Right: Press ◀▶ buttons to correct distortion at top right corner

Bottom Left: Press ◀▶ buttons to correct distortion at bottom left corner

Bottom Right: Press ◀▶ buttons to correct distortion at bottom right corner

- **PIP**

PIP function enables projector to show two different input sources at the same time in the same display. Before enabling this function, make sure to set "on" in PIP option.

Source: Press ENTER to set PIP "on", then press ENTER to select sub source.

*Note: The available input source of main and sub sources are shown as follows. Some matrixes cannot be supported.*



## Main/PIP Matrix

Main Source PIP source	COMPUTER1	COMPUTER2	HDMI	DisplayPort	HDBaseT	3G-SDI	DVI-D
COMPUTER1		–	–	△	○	–	○
COMPUTER2	–		–	△	○	–	○
HDMI	–	–		△	○	–	○
Display Port	△	△	△		–	△	–
HDBaseT	○	○	○	–		–	–
3G-SDI	–	–	–	△	○		○
DVI-D	○	○	○	–	–	○	

Allowed combination ○

Forbidden combination –

Allowed combination  
(Pixel rate <165MHz) △

## Position

**Top Left:** Selected sub source displays at Top Left position.

**Top Right:** Selected sub source displays at Top Right position

**Bottom Left:** Selected sub source displays at Bottom Left position.

**Bottom Right:** Selected sub source displays at Bottom Right position.

**PBP:** Selected sub source displays on the left-half screen.

- **Position and Phase**

Set up VGA signal display's V Position, H Position, Phase and Tracking.

- **3D**

Set up 3D format and sync method. The projector displays options available for 3D format. If there is no 3D signal, this function will not work. Please that ensure you have connected to input signal before you setup 3D. DO NOT undertake 3D setup without connecting to an input source.

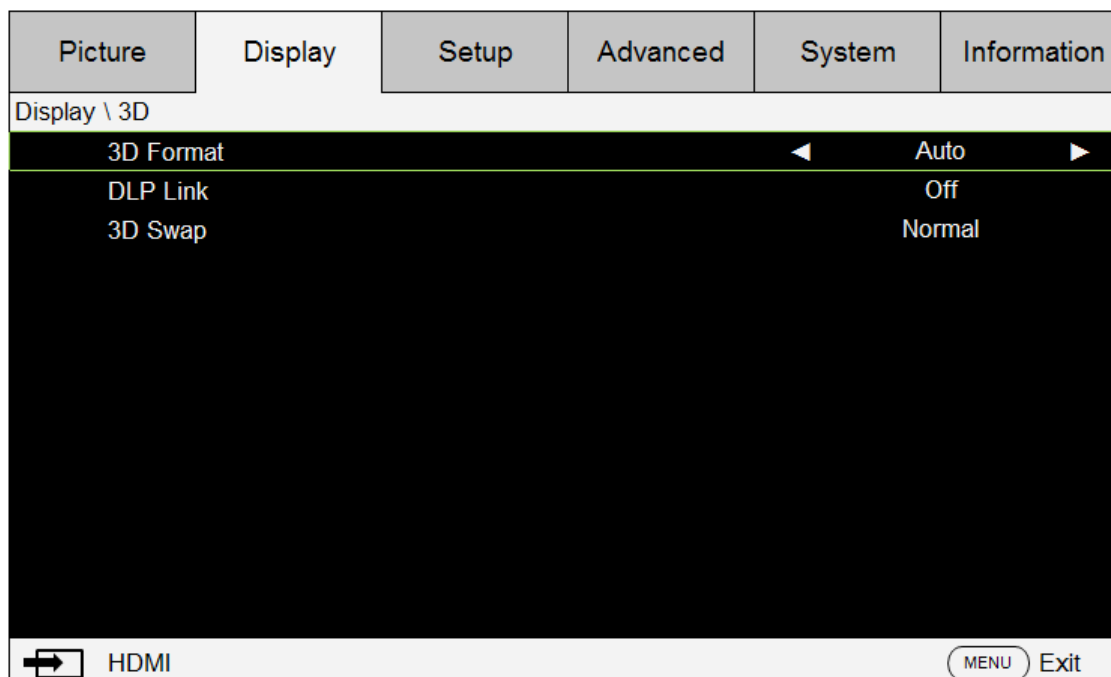

**3D Format:** Point to this option and press Enter key to enable 3D playback and set up 3D options.

**Off:** Disable 3D display mode. 3D mode is enabled once Auto, Side by Side, Top/Bottom or Frame Sequential mode is selected. To disable 3D mode, select Off and then press Enter.

**Auto:** Enable 3D format once Frame Packing, Side by Side, Top / Bottom, or Frame Sequential input format is detected. This function applies to the following input signal only:

## HDMI 1.4a 3D input signal

HDMI 1.4a 3D signal sent to the projector through digital transmitter

Side by Side: Set 3D format to Side by Side manually. This option applies to HDMI input signal or HDMI signal through a digital transmitter.

Top / Bottom: Set 3D format to Top / Bottom. This option applies to HDMI, DVI, or

DisplayPort input signals or these signals through digital transmitter.

Frame Sequential: Set input format to Frame Sequential.

DLP Link: Select to disable or enable DLP Link sync.

3D Swap: Set 3D Swap to reverse if left and right eye 3D image inversion by 3D glasses is needed. If image looks normal, keeps current settings, Normal, intact.

### **Caution:**

The projector supports DLP Link and 3D IR sync. After 3D mode is enabled, you can sync the signal of 3D glasses with both built-in DLP Link and external 3D IR transmitter or close the former and rely on the latter for 3D signal sync. Please remember:

- People with the following conditions should view 3D images with great care:

- Children under six years old
- Those with light sensitization disease, history of heart disease, or poor health
- Those experiencing physical fatigue or a lack of sleep
- Those under the influence of drugs or alcohol

- Under normal conditions it is safe to view 3D images. Some might feel uncomfortable. Please refer to the guidelines publicized by the 3D alliance on 2008-12-10. Please take at least 5-15 minutes rest for every 30-60 minutes viewing.

- **Color Space**

This function enables you to change color space of input signal. In most cases, you can select Auto to adopt the color space automatically set by the projector. You can select one of the following options to use specific color space instead:

**Auto:** The projector switches to valid color space by detecting input signal.

**YPbPr:** Set color space to ITU-R BT.601.

**YCbCr:** Set color space to ITU-R BT.709.

**RGB-PC:** Set color space to RGB with black set to 0, 0, 0 and white to 255, 255, 255 (for 8-bit image).

**RGB-Video:** Set color space to RGB with black set to 16, 16, 16 and white to 235, 235, 235 (for 8-bit image) to correspond brilliance values with values defined in digital component standard.

- **Reset Display**

Press “Yes” to reset all setting to default in Display OSD.

## OSD menu - Setup

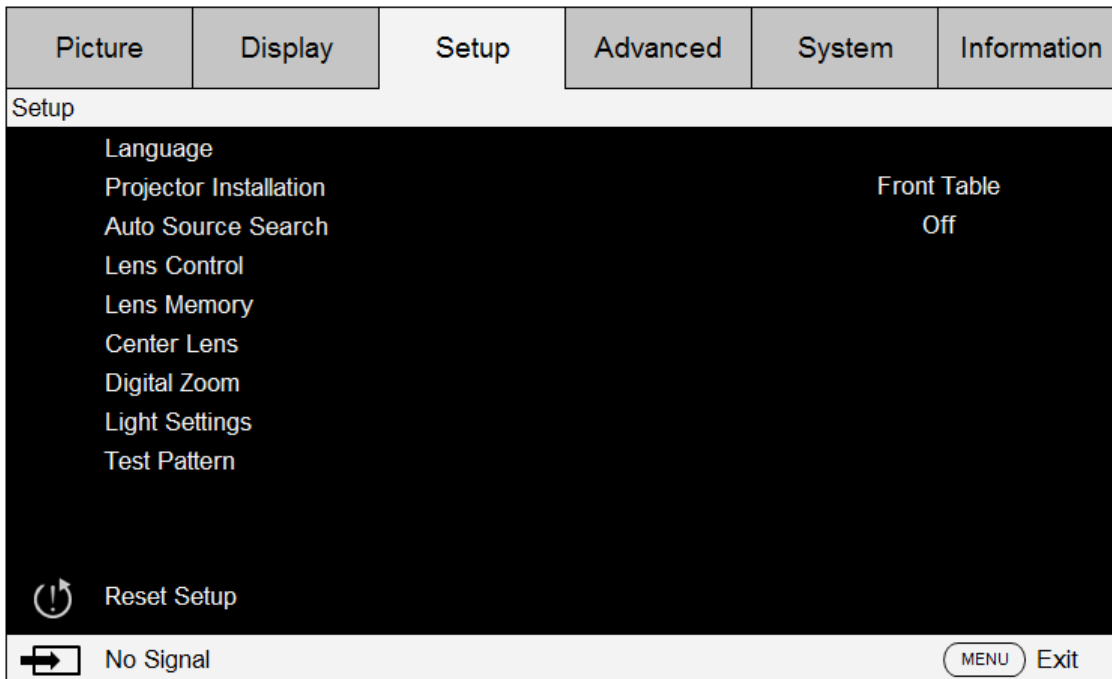

- **Language**  
Select desired language displayed in your OSD menu: English, French, Spanish, German, Italian, Swedish, Portuguese, Russian, Korean, Japanese, Traditional Chinese, Simplified Chinese.
- **Projector Installation**  
Press ◀▶ arrow key to select Projector Installation : Front Table, Rear Table, front Ceiling, rear Ceiling.

### Caution:

The cooling fan speed varies with projection mode to ensure the projector to properly discharge heat. Be careful to choose the correct projection mode when installing your projector.

- **Auto Source Search**  
Press ◀▶ arrow key to enable/disable the Auto Source Search.
- **Lens Control**  
Select this function or press the LENS Shift button on the remote controller to open the lens control menu to zoom, focus or shift the lens. Press Enter key to switch zoom/focus or lens shift menu, press ◀▶ arrow key focus the projected image or shift the lens in horizontal direction, and ▲▼ to zoom the projection size or shift the lens in vertical direction.

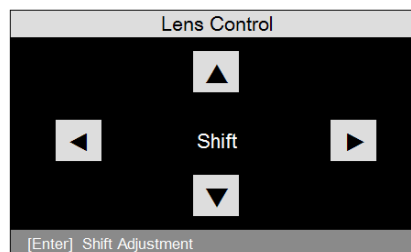
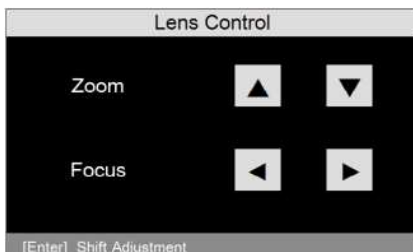

- **Lens Memory**  
The projector can memorize up to 10 sets of zoom, focus, and lens shift. You can give each group of settings a unique name with the virtual keyboard. You can save current lens position (horizontal and vertical), zoom and focus settings as well as retrieve and load saved lens memory for the projector to apply the newly loaded lens shift, zoom, and focus settings.  
**Load Memory:** To recall saved lens settings: press Enter key to display lens memory list, press

▲▼ arrow keys to select desired memory, and press Enter key again to retrieve and to load the saved lens settings. The projector can keep 10 groups of lens settings. The memory position with lens settings will be marked in a different color and you can select only one of those settings. To add or change lens memory, please select Edit Memory option below.

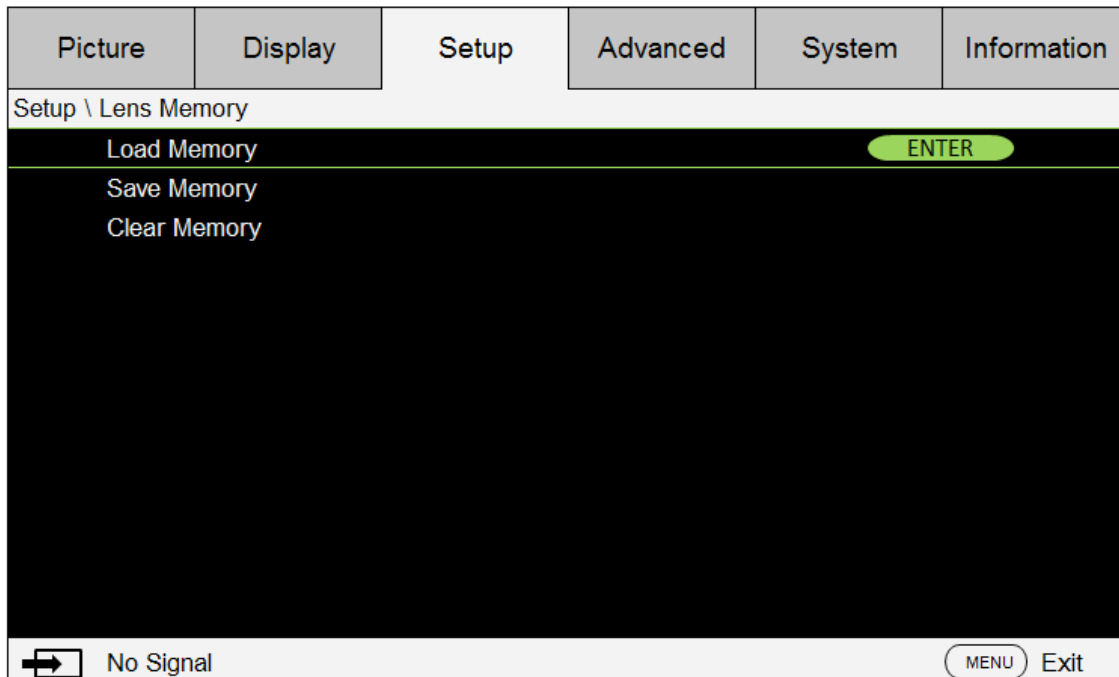

**Save Memory:** Edit memory name and save current memory settings including lens shift, zoom and focus. Press Enter key to display the virtual keyboard. Press ▲▼◀▶ and Enter keys to select or accept setup values.

**Clear Memory:** Select the memory set to be cleared and then press ENTER button to confirm clearing memory set.

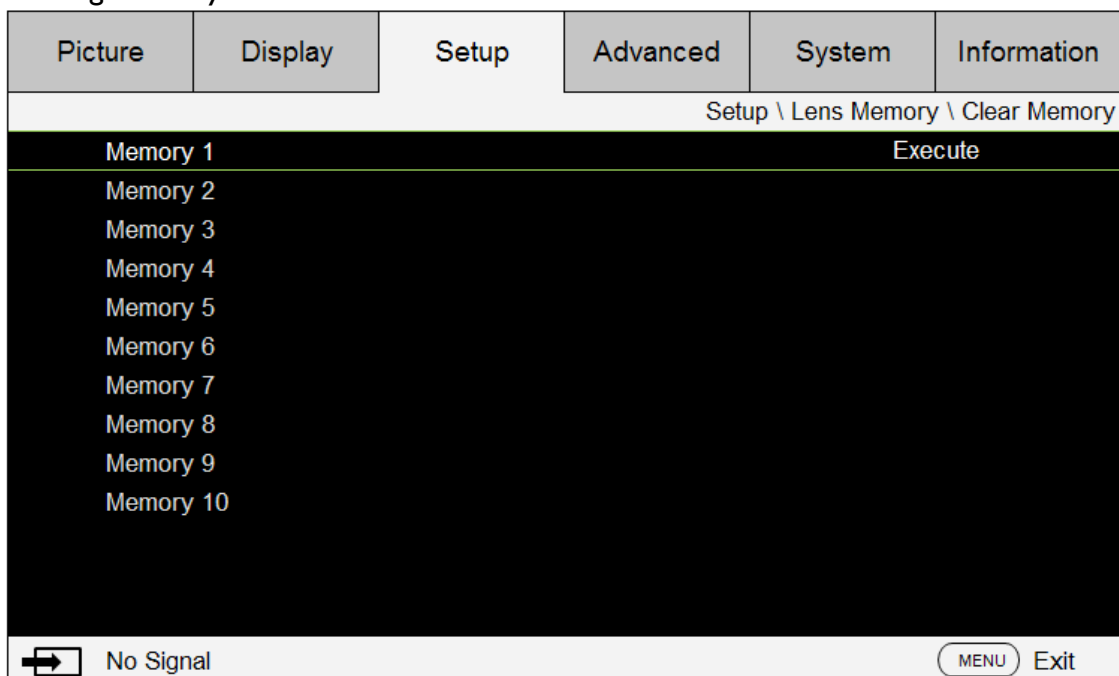

- **Center Lens:** This is the lens calibration function. The projector calibrates the lens shift, focus and zoom parameters for the precise lens memory function. After performing this function, the lens will be moved to the center position as factory default.

 **Note:**

- There are two default center positions for UST (Ultra Short Throw) Lens and non-UST Lens. Make sure Lens Type setting is correct before performing this function.
- If Ultra Short Throw Lens is installed, make sure the support kit is detached before performing Center Lens.

- **Digital Zoom**

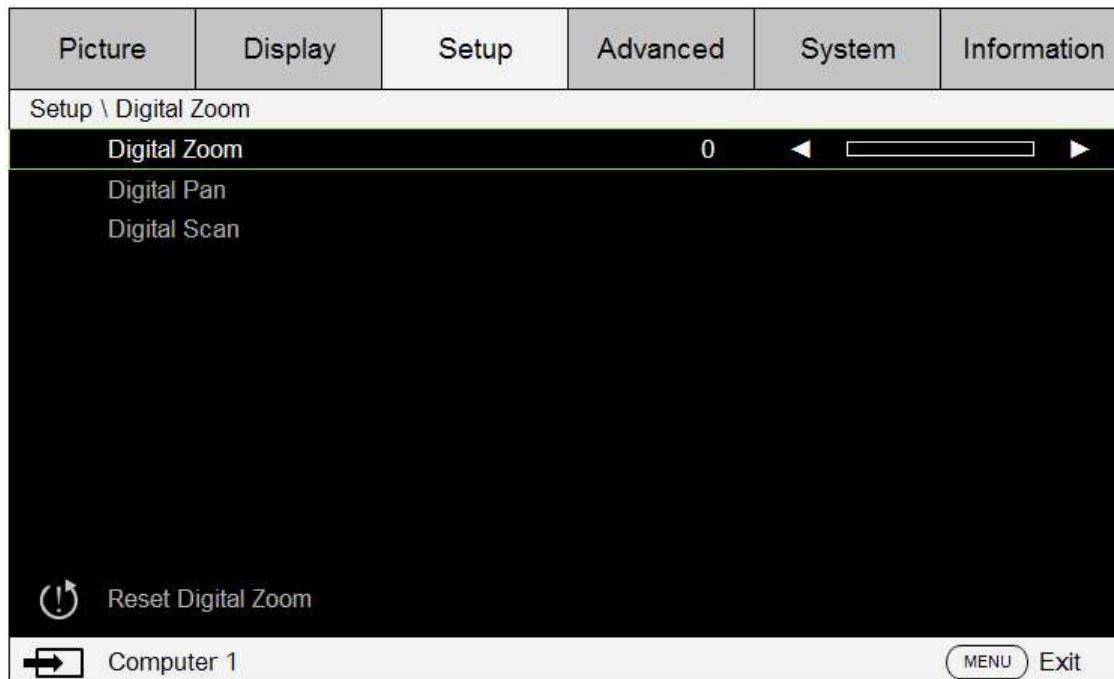

**Digital Zoom:** Press ◀▶ arrow key to zoom in the projection image.

**Digital Pan:** Press ◀▶ arrow key to pan out on projection image. This is valid only when the projected image is enlarged.

**Digital Scan:** Press ◀▶ arrow key to tilt projection image. This is valid only when the projected image is enlarged.

**Reset:** Press to reset Digital Alignment settings to factory default values.

 **Caution:**

Please execute the Center Lens function every time once a lens is installed. It can ensure that the projector memorizes the exact lens settings.

- **Light Settings**

**Light Mode**

Press ◀▶ arrow keys to select ECO (power saving), Normal, or Custom Power Level.

ECO: To project in economic mode for longer life cycle.

Normal: To project at normal power for the highest brightness output.

Custom Power Level:

Press ◀▶ arrow keys to customize light output power in the range of 20-100% of normal mode. This function is valid only when the Power option is set to Custom Power Level mode. In the other two modes, Normal and ECO, this function is disabled (dimmed).

This function helps for fast installation of multiple projectors and regular maintenance.

**High Altitude**

You can use this function to turn the option to ON for switching the cooling setting if the project is installed in a high altitude environment, the default is AUTO.

AUTO: When setting to Auto, system will auto calculate by atmosphere pressure, it may have calculate biao compare to actual altitude.

When the temperature rises, the cooling fan speeds up, accompanying (higher louder noise) to exhaust the internal heat out of the projector ensuring its normal operation. However, the projector may turn off automatically if it is used in an environment with at excessively high temperature or in an area at a high altitude. In this case, you can enable this function by setting it to ON and have the cooling fan speed up to control the internal temperature of the projector.

 **Note:**

An area is considered high altitude when it is above 5000 feet.

- **Test Pattern**

The projector features a set of test patterns for installation and adjustment. Select the test pattern function in OSD or press the TEST PATTERN button on your remote controller to display the first test pattern, press again to display the next one. Repeat to scroll through available test pattern or press the Exit button to exit.

- **Reset Setup**

Press “Yes” to reset all settings to default in Setup OSD.

## OSD menu - Advanced

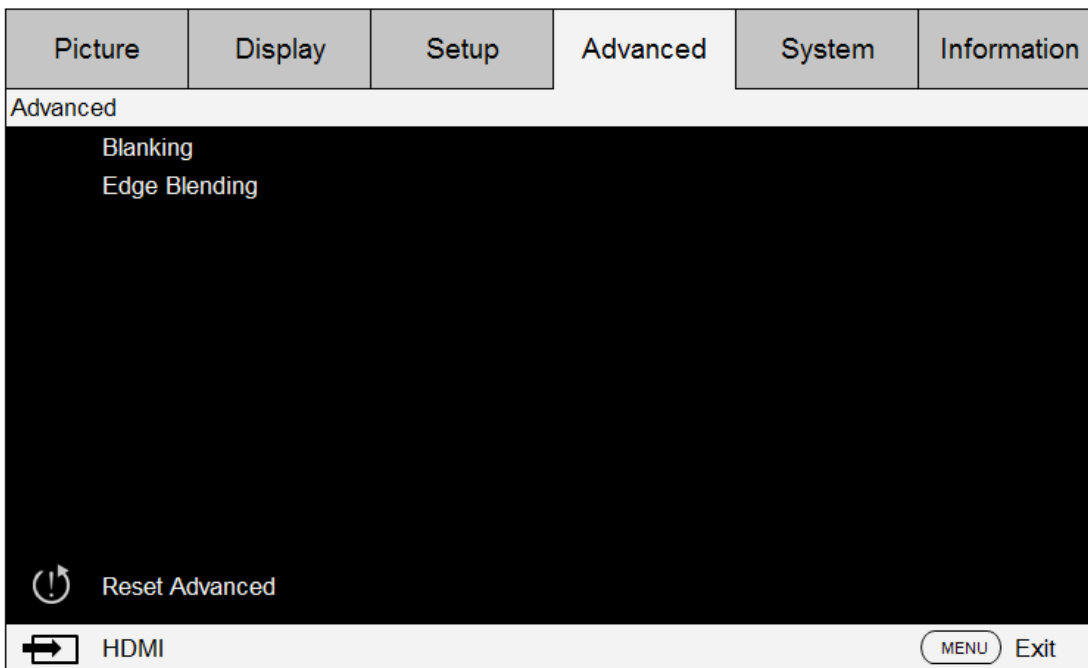

- **Blanking**

Select the edge you would like to blank (Top, Bottom, Left, and Right).

- **Edge Blending**

This function enables you to display multiple projection images in on the same screen simultaneously, using edge blending function to uniform images. To enable this function, please set status to “on”.

**Status:** Select on to enable edge blending.

**Adjust Lines:** Select adjust lines to on, enabling user to adjust overlapping area.

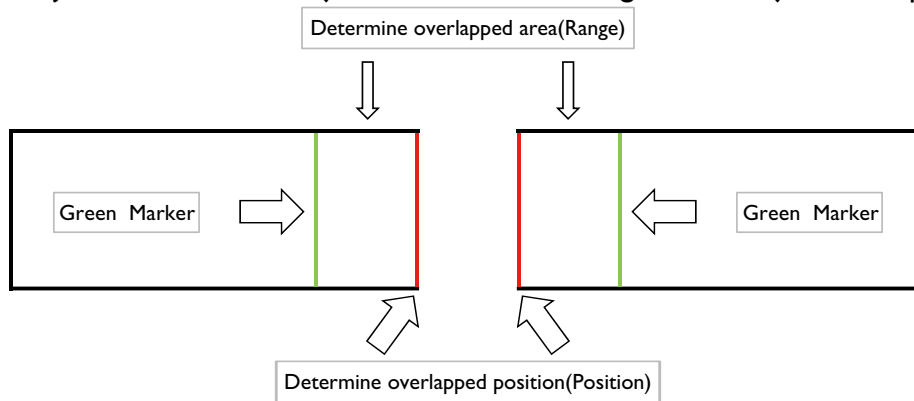

**White Level:** White level is to adjust the overlapping area for the blending. By selecting the areas of Top, Bottom, Left, and Right, the overlapping area can be optimized as the non-overlapping area to display a seamless picture. Adjust the line to the Edge pixel line of the other projector.

**Black Level:** Black level is to compensate the non-overlapping area if the blending region is brighter. The Red, Green, and Blue of the projector can be adjusted both simultaneously and independently.

**Reset Edge Blending:** Reset edge blending settings to default setting values.



**Note:**

### Step for Edge Blending

1. Execute “Reset to Default Setting”, for all setting value back to default.
2. In a scenario projectors being placed side by side, use zoom/focus/lens shift to the most similar condition. The Four Corner/ Keystone can also be applied to adjust its shape. Use a grid pattern to confirm if the blending area are overlapped well.
3. Use custom light mode to adjust the brightness level if the brightness of the projectors are not at the same level.
4. Set edge blending status to “on”.
5. Set Adjust Lines to “on” so as to see the area being adjusted.
6. Set white level for each projector. The blending area is decided by the projected image; take an example of the following picture, adjust the Right area of projector A, and adjust the left area of projector B.
7. Set black level to adjust non-overlapping area.

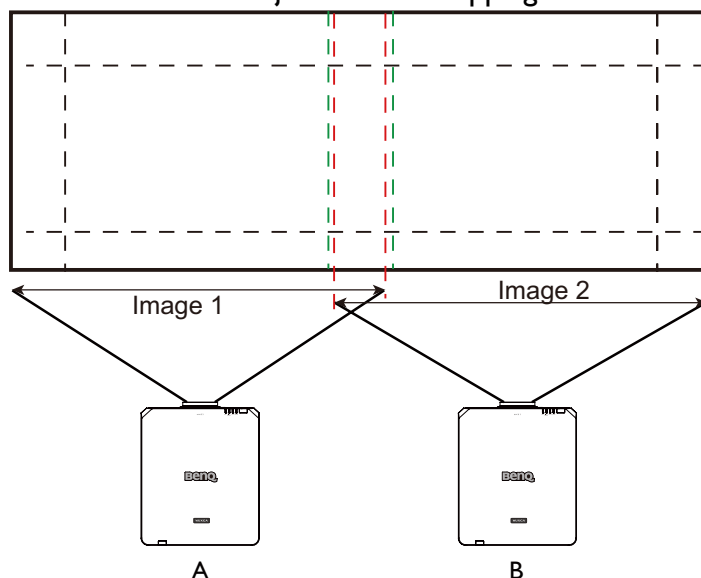

## OSD menu - System

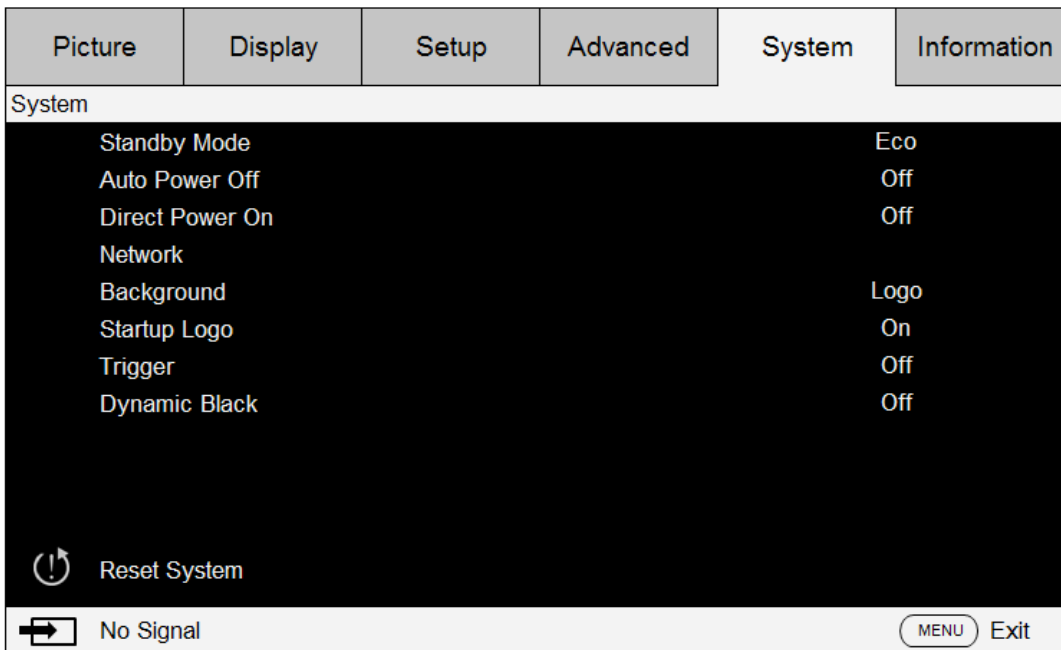

- **Standby Mode**

Press ◀▶ arrow key to toggle switch between Standard, ECO and Network mode.

**Network:** The projector maintains in the standby status at the power consumption under 6W, the projector can be turned on using the power button or network control only, RS-232 control command and wired remote control signal via external transmitter through RJ45 cable are not available.

**Eco:** The projector maintains in the standby status at the lowest power (<0.5W). In this mode, the projector can be turned on only using the power button on the remote controller or projector.



**Note:**

Some of communication ports are turned off if it is set to ECO or Network mode. Please make sure that the standby mode is set to proper setting.

- **Auto Power off**

The default setting is Off. The projector powers off automatically after 20 minutes without input signal when set to On.

- **Direct Power on**

The default setting is Off. The projector powers on automatically once it is connected to any AC power supply if set to On.

- **Network**

You can use the network function to configure a network for projector control.



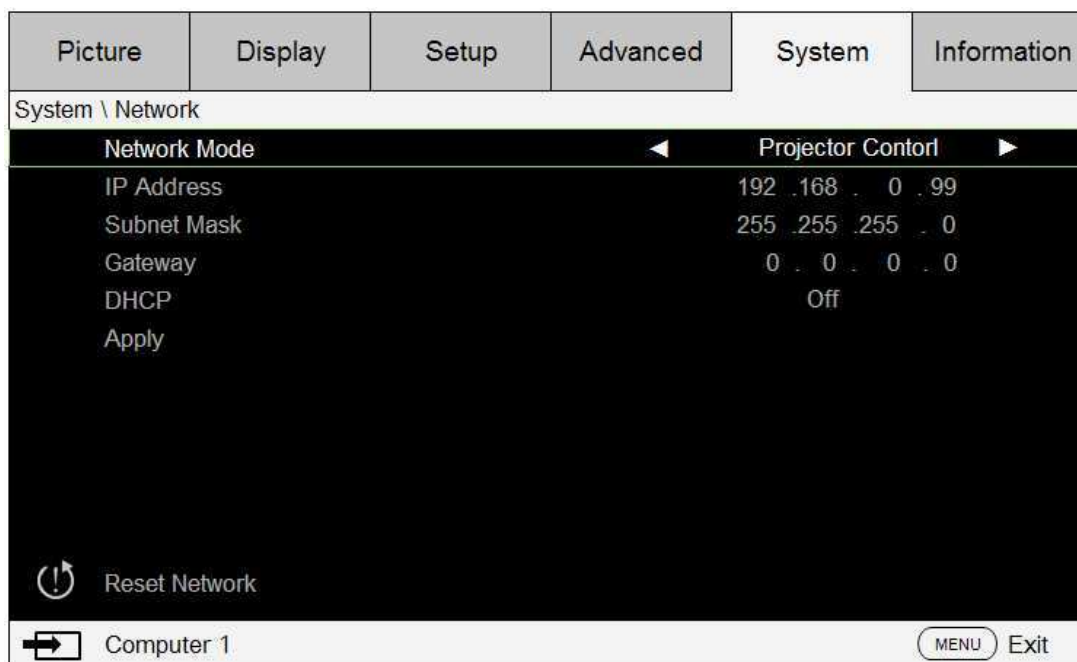

Press ▲ ▼ arrow keys and Enter key to select network and its settings:

**IP Address:** To specify an IP address, press the Enter button to show the IP address input window. Use the ◀ ▶ buttons to select the number in the address to be changed. Use the ▲ ▼ buttons to increase or decrease the number in the IP address.

**Subnet Mask:** Set up IP address of subnet.

**Gateway:** Set up IP address of gateway.

**DHCP:** Set DHCP to On or Off. If this is set to On, the DHCP server of the network domain assigns an IP address to the projector. That is, the IP address is displayed in the address window instead of being entered manually. Otherwise, the domain does not or cannot assign an IP address, and 0.0.0.0 is shown on the IP address window.

**Apply:** Select this button and press Enter. It takes several seconds to execute the change in network settings till the following message disappears.

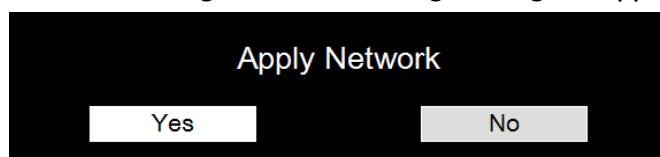

For further information on network control connections and settings, please refer to the Remote control manual.

- **Background**

This function can be used to select pictures or color displayed on the blank screen. The background colors that you can select include logo, blue, black and white.

- **Startup Logo**

Press ◀ ▶ arrow keys to enable /disable the startup logo function.

- **Trigger**

The projector features one trigger output. If the projector comes with an auto screen device, you can connect it to the trigger to open the screen when the projector powers up. This function may have a 2-3 second lag before powering up.

- **Dynamic Black**

This function allows the projector to automatically adjust the contrast of the image during the



projection.

Press ◀▶ arrow key to enable/disable dynamic black mode.

- **Reset System**

Press “Yes” to reset all settings to default in System OSD.

## OSD menu - Information

Picture	Display	Setup	Advanced	System	Information
Information					
Model		BenQ Projector			
Serial Number		9876543219876			
Software Version		MD05-SD07-FD16-LD03-22-RD02-3092			
Active Source		Computer 1			
Pixel Clock		154.000 MHz			
Signal Format		1920x1200@60Hz RB			
H/V Refresh Rate		H: 74.038 KHz V: 59.95Hz			
Light Source Usage		00126 HRS			
Thermal Status					
 Reset to Default Setting					
 Computer 1		 Exit			

Display basic information of the projector.

- **Model**  
Projector model number.
- **Serial Number**  
Projector serial number.
- **Software Version**  
Version of software installed in the projector.
- **Active Source**  
Display signal source being used.
- **Pixel Clock**  
Display pixel clocking of current input signal.
- **Signal Format**  
Display signal format of current input signal.
- **H/V Refresh Rate**  
Display horizontal and vertical refresh rate of current image.
- **Light Source Usage**  
Display operation hours of the projector.
- **Thermal Status**  
The projector displays thermal detection temperature, also with fan speed RMP.
- **Reset to Default Setting**  
Select this option to reset menu settings, including every user defined value, back to factory default.



### Caution:

Light source usage remain intact when reset settings to factory default.

## Additional information

### Cleaning the lens

Clean the lens whenever you notice dirt or dust on the surface. Before you attempt to clean the lens, turn the projector off, unplug the power cable, and leave it several minutes to cool completely. Use a canister of compressed air to remove dust. (available from building hardware or photographic suppliers.)

If there is stubborn dirt or smudge marks, use a proper photographic lens brush or moisten a clean soft lens cloth with lens cleaner to gently wipe the lens surface.

Never use any type of abrasive pad, alkaline/acid cleaner, scouring powder, or volatile solvent, such as alcohol, benzene, thinner or insecticide. Using such materials or maintaining prolonged contact with rubber or vinyl materials may result in damage to the projector surface and cabinet material.



#### Note:

Never touch the lens with your finger or rub the lens with abrasive materials. Even paper towels can damage the lens coating. Only ever use a proper photographic lens brush, cloth, and cleaning solution.

Do not attempt to clean the lens while the projector is switched on or is still hot from previous use. Be sure to turn off the projector and let it cool down completely before cleaning the lens.

### Care of the projector

Your projector needs little maintenance. The only thing you have to do on a regular basis is keep the lens clean. Never remove any parts of the projector. Contact your dealer or local customer service center if the projector fails to operate as expected.

### Cleaning the projector case

Before you attempt to clean the case, turn the projector off, unplug the power cable, and leave it several minutes to cool completely.

To remove dirt or dust, wipe the case with a soft, dry, lint-free cloth.

To remove stubborn dirt or stains, moisten a soft cloth with water and a neutral detergent. Then wipe the case.



Never use wax, alcohol, benzene, thinner any other chemical detergents. These can damage the case.

### Storing the projector

If you need to store the projector for an extended time, please:

Make sure the temperature and humidity of the storage area are within the recommended range for the projector. Please refer to the Spec. page in this manual or consult your dealer about the range.

Retract the adjuster feet.

# Specifications

Model		LU9715	
Display Device		Single Chip 0.67" DLP Technology	
Resolution		WUXGA	
Input Terminals	HDMI (Compatible with HDCP)		
	DVI-D (Compatible with HDCP)		
	Display Port (Compatible with HDCP)		
	3G-SDI In (Compatible with HDCP)		
	Computer-1 (D-sub 15p)		
	Computer-2 (5BNC)		
	HDBaseT (Shared with RJ-45)		
Output Terminals	Monitor Out (D-sub 15 p)		
	Trigger ( $\varnothing$ 3.5mm stereo min jack)	X1 (DC 12V Output)	
	3D IR Sync (VESA mini din)		
	3G-SDI Out		
Control and Service	Lan (RJ-45)		
	Wired Remote ( $\varnothing$ 3.5mm stereo min jack)		
	RS-232		
Power Requirement		AC 100-130V	AC 200-240V
Input Current		9.50A	4.50A
Power Consumption (Normal Mode)		885W@110V (max), 845W@220V (max)	
Operation Temperature		32°F to 104°F (0°C to 40°C )	
Storage Temperature		14°F to 140°F (-10°C to 60°C), 5% to 95% Humidity (non-condensing)	
Dimensions		22.95" x 19.6" x 8.31" 583mm(L) x 500mm(W) x 211mm(H) (not including protrusions or feet)	
Net Weight (Projector Only)		28kg	

# Dimension

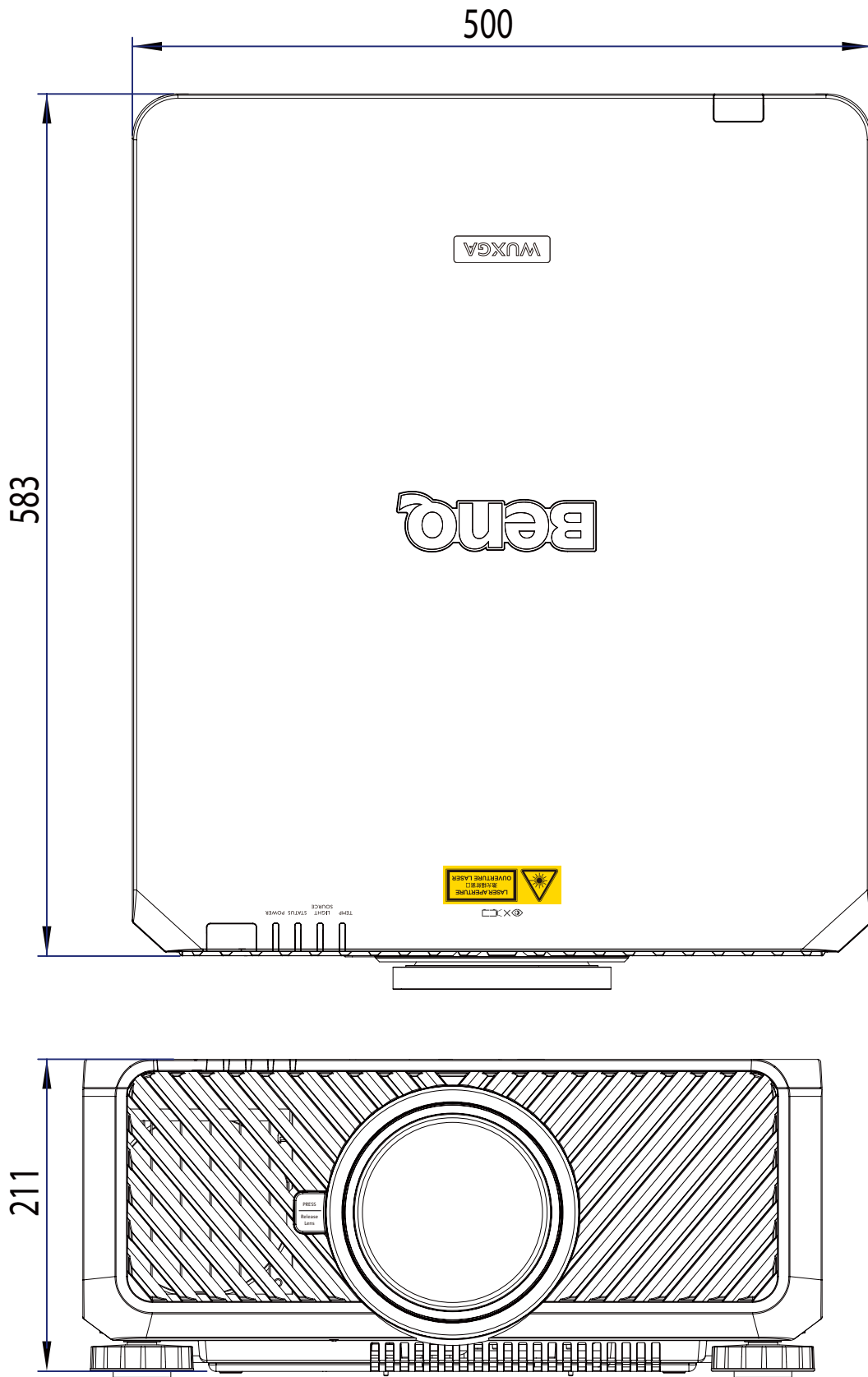

# Timing chart

The following table shows compatible signal types, their resolution and frequency refresh rates.

Horizontal: 15kHz, 31kHz to 90 kHz, Vertical: 50 Hz to 85 Hz.

Signal Format	Resolution	Frame Rate (Hz)	Computer 1,2 -SOG	Computer 1,2 - RGBHV		DisplayPort / DVI-D	HDMI / HD-BaseT	RGB	YUV			HD/SDI 3G
									8-bit	10-bit	12-bit	
PC	640x480	59.94		X	X	X	X					
	640x480	74.99		X	X	X	X					
	640x480	85		X	X	X	X					
	800x600	60.32		X	X	X	X					
	800x600	75		X	X	X	X					
	800x600	85.06		X	X	X	X					
	848x480	47.95		X	X	X	X					
	848x480	59.94		X	X	X	X					
	1024x768	60		X	X	X	X					
	1024x768	75		X	X	X	X					
	1024x768	85		X	X	X	X					
	1152x864	75		X	X	X	X					
	1280x720	47.95		X	X	X	X					
	1280x800	75		X	X	X	X					
	1280x1024	60.02		X	X	X	X					
	1280x1024	75.02		X	X	X	X					
	1280x1024	85.02		X	X	X	X					
	1366x768	60		X	X	X	X					
	1600x1200	60		X	X	X	X					
	1920x1080	47.95		X	X	X	X					
	1680x1050	59.94		X	X	X	X					
	1920x1200 RB	50		X	X	X	X					
	1920x1200 RB	60		X	X	X	X					
	1400x1050	60		X	X	X	X					
	1366 x 768	60		X	X	X	X					
1440 x 900	60		X	X	X	X						
1280 x 768	60		X	X	X	X						
1280 x 800	60		X	X	X	X						
1280 x 960	60		X	X	X	X						
Apple Mac	640x480	66.59		X	X	X	X					
	832x624	74.54		X	X	X	X					
	1024x768	75		X	X	X	X					
	1152x870	75		X	X	X	X					
SDTV	480i	59.94	X								X	
	1440x480i	60					X	X	X			
	1440x576i	50					X	X	X			
	576i	50	X								X	
EDTV	480p	59.94	X	X	X	X	X	X	X	X		
	576p	50	X	X	X	X	X	X	X	X		

Signal Format	Resolution	Frame Rate (Hz)	Computer 1,2 -SOG	Computer 1,2 - RGBHV	DisplayPort / DVI-D	HDMI / HD-BaseT	RGB	YUV			HD/SDI 3G
								8-bit	10-bit	12-bit	
								HDTV	1035i	60	X
1080i	50	X	X	X	X	X	X		X	X	X
1080i	59.94	X	X	X	X	X	X		X	X	X
1080i	60	X	X	X	X	X	X		X	X	X
720p	50	X	X	X	X	X	X		X	X	X
720p	59.94	X	X	X	X	X	X		X	X	X
720p	60	X	X	X	X	X	X		X	X	X
1080p	23.98	X	X	X	X	X	X		X	X	X
1080p	24	X	X	X	X	X	X		X	X	X
1080p	25	X	X	X	X	X	X		X	X	X
1080p	29.97	X	X	X	X	X	X		X	X	x
HDTV	1080p	30	X	X	X	X	X	X	X	X	X
	1080p	50	X	X	X	X	X	X	X	X	X
	1080p	59.94	X	X	X	X	X	X	X	X	X
PsF formats	1080sf	30									X
	1080sf	25									X
X=support timing											

## 3D supported timing

3D formats		Resolution	V-Freq (Hz)	V-Total	H-Freq (kHz)	HDMI/ HDBaseT	DisplayPort /DVI-D
720p50	Frame Packing	1280x720	50	1470	37.5	V	
720p59	Frame Packing	1280x720	59.94	1470	44.96	V	
720p60	Frame Packing	1280x720	60	1470	45	V	
720p50	Top-and-Bottom	1280x720	50	750	37.5	V	V
720p59	Top-and-Bottom	1280x720	59.94	750	44.96	V	V
720p60	Top-and-Bottom	1280x720	60	750	45	V	V
1080p23	Frame Packing	1920x1080	23.98	2205	26.97	V	
1080p24	Frame Packing	1920x1080	24	2205	27	V	
1080i50	Side-by-Side (Half)	1920x1080	50	1125	56.25	V	V
1080i59	Side-by-Side (Half)	1920x1080	59.94	1125	67.43	V	V
1080i60	Side-by-Side (Half)	1920x1080	60	1125	67.5	V	V
1080p50	Side-by-Side (Half)	1920x1080	50	1125	56.25	V	V
1080p59	Side-by-Side (Half)	1920x1080	59.94	1125	67.43	V	V
1080p60	Side-by-Side (Half)	1920x1080	60	1125	67.5	V	V
1080p50	Top-and-Bottom	1920x1080	50	1125	56.25	V	V

3D formats		Resolution	V-Freq (Hz)	V-Total	H-Freq (kHz)	HDMI	DisplayPort /DVI-D
1080p59	Top-and-Bottom	1920x1080	59.94	1125	67.43	V	V
1080p60	Top-and-Bottom	1920x1080	60	1125	67.5	V	V
1080p50	Frame Sequential	1920x1080	50	1125	56.25	V	V
1080p59	Frame Sequential	1920x1080	59.94	1125	67.43	V	V
1080p60	Frame Sequential	1920x1080	60	1125	67.5	V	V

### 3D Glasses specification

- Refreshing rate: 96/100/120Hz
- Sync operation type: DLP Link / IR



- An image with higher or lower resolution than the projector's native resolution will be compressed.
- Some Sync on Green signals may not be displayed correctly.
- Signals other than those specified in the table above may not be displayed correctly. If this should happen, change the refresh rate or resolution on your PC.



## RS232 command control

Function	Type	Description	ASCII
Power	Write	Power On	<CR>*pow=on#<CR>
	Write	Power off	<CR>*pow=off#<CR>
	Read	Power Status	<CR>*pow=?#<CR>
Source Selection	Write	COMPUTER/YPbPr	<CR>*sour=RGB#<CR>
	Write	COMPUTER 2/YPbPr2	<CR>*sour=RGB2#<CR>
	Write	DVI-D	<CR>*sour=dvid#<CR>
	Write	HDMI	<CR>*sour=hdmi#<CR>
	Write	DisplayPort	<CR>*sour=dp#<CR>
	Write	3G-SDI	<CR>*sour=sdi#<CR>
	Write	HDBaseT	<CR>*sour=hdbaset#<CR>
	Read	Current source	<CR>*sour=?#<CR>
Picture Setting	Write	Bright	<CR>*appmod=bright#<CR>
	Write	Presentation	<CR>*appmod=preseT#<CR>
	Write	Cinema	<CR>*appmod=cine#<CR>
	Read	Picture Mode	<CR>*appmod=?#<CR>
	Write	Brightness +	<CR>*bri=+#<CR>
	Write	Brightness -	<CR>*bri=-#<CR>
	Read	Brightness value	<CR>*bri=?#<CR>
	Write	Contrast +	<CR>*con=+#<CR>
	Write	Contrast -	<CR>*con=-#<CR>
	Read	Contrast value	<CR>*con=?#<CR>
	Write	Hue +	<CR>*hue=+#<CR>
	Write	Hue -	<CR>*hue=-#<CR>
	Read	Hue value	<CR>*hue=?#<CR>
	Write	Color +	<CR>*color=+#<CR>
	Write	Color -	<CR>*color=-#<CR>
	Read	Color value	<CR>*color=?#<CR>
	Write	Sharpness +	<CR>*sharp=+#<CR>
	Write	Sharpness -	<CR>*sharp=-#<CR>
	Read	Sharpness value	<CR>*sharp=?#<CR>
	Write	Gamma 1.0	<CR>*gm=1.0#<CR>
	Write	Gamma 1.8	<CR>*gm=1.8#<CR>
	Write	Gamma 2.0	<CR>*gm=2.0#<CR>
	Write	Gamma 2.2	<CR>*gm=2.2#<CR>
	Write	Gamma 2.35	<CR>*gm=2.35#<CR>
	Write	Gamma 2.5	<CR>*gm=2.5#<CR>
	Read	Gamma Status	<CR>*gm=?#<CR>
	Write	Noise Reduction +	<CR>*nr=+#<CR>
	Write	Noise Reduction -	<CR>*nr=-#<CR>
	Read	Noise Reduction value	<CR>*nr=?#<CR>

<b>Picture Setting</b>	Write	Overscan Off	<CR>*ov=off#<CR>	
	Write	Overscan Crop	<CR>*ov=crop#<CR>	
	Write	Overscan Zoom	<CR>*ov=zoom#<CR>	
	Read	Overscan Status	<CR>*ov=?#<CR>	
	Write	Reset picture settings	<CR>*picture=reset#<CR>	
	Write	Digital Zoom In	<CR>*zoomI#<CR>	
	Write	Digital Zoom out	<CR>*zoomO#<CR>	
	Write	Auto	<CR>*auto#<CR>	
	Write	Color Temperature-Warmer(5400K)	<CR>*ct=warmer#<CR>	
	Write	Color Temperature-Warm (6500K)	<CR>*ct=warm#<CR>	
	Write	Color Temperature-Normal (7500K)	<CR>*ct=normal#<CR>	
	Write	Color Temperature-Cool (9300K)	<CR>*ct=cool#<CR>	
	Write	Color Temperature-lamp native	<CR>*ct=ative#<CR>	
	Read	Color Temperature Status	<CR>*ct=?#<CR>	
	Write	Color Red Offset +	<CR>*roffset=+#<CR>	
	Write	Color Red Offset -	<CR>*roffset=-#<CR>	
	Read	Color Red Offset value	<CR>*roffset=?#<CR>	
	Write	Color Green Offset +	<CR>*goffset=+#<CR>	
	Write	Color Green Offset -	<CR>*goffset=-#<CR>	
	Read	Color Green Offset value	<CR>*goffset=?#<CR>	
	Write	Color Blue Offset +	<CR>*boffset=+#<CR>	
	Write	Color Blue Offset -	<CR>*boffset=-#<CR>	
	Read	Color Blue Offset value	<CR>*boffset=?#<CR>	
	<b>Picture Settings : Color Adjustment</b>	Write	Color Red Gain +	<CR>*rgain=+#<CR>
		Write	Color Red Gain -	<CR>*rgain=-#<CR>
		Read	Color Red Gain value	<CR>*rgain=?#<CR>
		Write	Color Green Gain +	<CR>*ggain=+#<CR>
		Write	Color Green Gain -	<CR>*ggain=-#<CR>
		Read	Color Green Gain value	<CR>*ggain=?#<CR>
		Write	Color Blue Gain +	<CR>*bgain=+#<CR>
		Write	Color Blue Gain -	<CR>*bgain=-#<CR>
		Read	Color Blue Gain value	<CR>*bgain=?#<CR>
<b>Picture Settings : Hue</b>		Write	Hue Red +	<CR>*huer=+#<CR>
		Write	Hue Red -	<CR>*huer=-#<CR>
		Read	Hue Red value	<CR>*huer=?#<CR>
	Write	Hue Green +	<CR>*hueg=+#<CR>	
	Write	Hue Green -	<CR>*hueg=-#<CR>	
	Read	Hue Green value	<CR>*hueg=?#<CR>	
	Write	Hue Blue +	<CR>*hueb=+#<CR>	
	Write	Hue Blue -	<CR>*hueb=-#<CR>	
Read	Hue Blue value	<CR>*hueb=?#<CR>		

<b>Picture Settings : Hue</b>	Write	Hue Cyan +	<CR>*huec=+#<CR>
	Write	Hue Cyan -	<CR>*huec=-#<CR>
	Read	Hue Cyan value	<CR>*huec=?#<CR>
	Write	Hue Magenta +	<CR>*huem=+#<CR>
	Write	Hue Magenta -	<CR>*huem=-#<CR>
	Read	Hue Magenta value	<CR>*huem=?#<CR>
	Write	Hue Yellow +	<CR>*huey=+#<CR>
	Write	Hue Yellow -	<CR>*huey=-#<CR>
	Read	Hue Yellow value	<CR>*huey=?#<CR>
<b>Picture Settings : Saturation</b>	Write	Saturation Red +	<CR>*satr=+#<CR>
	Write	Saturation Red -	<CR>*satr=-#<CR>
	Read	Saturation Red value	<CR>*satr=?#<CR>
	Write	Saturation Green +	<CR>*satg=+#<CR>
	Write	Saturation Green -	<CR>*satg=-#<CR>
	Read	Saturation Green value	<CR>*satg=?#<CR>
	Write	Saturation Blue +	<CR>*satb=+#<CR>
	Write	Saturation Blue -	<CR>*satb=-#<CR>
	Read	Saturation Blue value	<CR>*satb=?#<CR>
	Write	Saturation Cyan +	<CR>*sac=+#<CR>
	Write	Saturation Cyan -	<CR>*sac=-#<CR>
	Read	Saturation Cyan value	<CR>*sac=?#<CR>
	Write	Saturation Magenta +	<CR>*satm=+#<CR>
	Write	Saturation Magenta -	<CR>*satm=-#<CR>
	Read	Saturation Magenta value	<CR>*satm=?#<CR>
	Write	Saturation Yellow +	<CR>*saty=+#<CR>
	Write	Saturation Yellow -	<CR>*saty=-#<CR>
	Read	Saturation Yellow value	<CR>*saty=?#<CR>
<b>Picture Settings : Gain</b>	Write	Gain Red +	<CR>*gainr=+#<CR>
	Write	Gain Red -	<CR>*gainr=-#<CR>
	Read	Gain Red value	<CR>*gainr=?#<CR>
	Write	Gain Green +	<CR>*gaing=+#<CR>
	Write	Gain Green -	<CR>*gaing=-#<CR>
	Read	Gain Green value	<CR>*gaing=?#<CR>
	Write	Gain Blue +	<CR>*gainb=+#<CR>
	Write	Gain Blue -	<CR>*gainb=-#<CR>
	Read	Gain Blue value	<CR>*gainb=?#<CR>
	Write	Gain Cyan +	<CR>*gainc=+#<CR>
	Write	Gain Cyan -	<CR>*gainc=-#<CR>
	Read	Gain Cyan value	<CR>*gainc=?#<CR>
	Write	Gain Magenta +	<CR>*gainm=+#<CR>
	Write	Gain Magenta -	<CR>*gainm=-#<CR>
	Read	Gain Magenta value	<CR>*gainm=?#<CR>

<b>Picture Settings : Gain</b>	Write	Gain Yellow +	<CR>*gainy=+#<CR>
	Write	Gain Yellow -	<CR>*gainy=-#<CR>
	Read	Gain Yellow value	<CR>*gainy=?#<CR>
<b>Picture Settings : White Balance</b>	Write	White balance Red +	<CR>*wbr=+#<CR>
	Write	White balance Red -	<CR>*wbr=-#<CR>
	Read	White balance Red value	<CR>*wbr=?#<CR>
<b>Picture Settings : White Balance</b>	Write	White balance Green +	<CR>*wbg=+#<CR>
	Write	White balance Green -	<CR>*wbg=-#<CR>
	Read	White balance Green value	<CR>*wbg=?#<CR>
	Write	White balance Blue +	<CR>*wbb=+#<CR>
	Write	White balance Blue -	<CR>*wbb=-#<CR>
	Read	White balance Blue value	<CR>*wbb=?#<CR>
<b>Display</b>	Write	Aspect 4:3	<CR>*asp=4:3#<CR>
	Write	Aspect 16:9	<CR>*asp=16:9#<CR>
	Write	Aspect 16:10	<CR>*asp=16:10#<CR>
	Write	Aspect Auto (Aspect Source)	<CR>*asp=AUTO#<CR>
	Write	Aspect Real (Aspect Unscaled)	<CR>*asp=REAL#<CR>
	Write	Aspect Theater Scpoe	<CR>*asp=THEA#<CR>
	Write	Aspect 5:4	<CR>*asp=5:4#<CR>
	Write	Aspect 1.88	<CR>*asp=1.88#<CR>
	Write	Aspect 2.35	<CR>*asp=2.35#<CR>
	Read	Aspect Status	<CR>*asp=?#<CR>
	Write	V Position +	<CR>*vpos=+#<CR>
	Write	V Position -	<CR>*vpos=-#<CR>
	Read	Current V Position	<CR>*vpos=?#<CR>
	Write	H Position +	<CR>*hpos=+#<CR>
	Write	H Position -	<CR>*hpos=-#<CR>
	Read	Current H Position	<CR>*hpos=?#<CR>
	Write	Phase +	<CR>*phase=+#<CR>
	Write	Phase -	<CR>*phase=-#<CR>
	Read	Current Phase	<CR>*phase=?#<CR>
	Write	Tracking +	<CR>*tracking=+#<CR>
	Write	Tracking -	<CR>*tracking=-#<CR>
	Read	Current Tracking	<CR>*tracking=?#<CR>
	Write	Sync level +	<CR>*synclevel=+#<CR>
	Write	Sync level -	<CR>*synclevel=-#<CR>
	Read	Current Sync level	<CR>*synclevel=?#<CR>
	Write	Color space Auto	<CR>*cs=auto#<CR>
	Write	Color space YPbPr	<CR>*cs=yp#<CR>
	Write	Color space YCbCr	<CR>*cs=yc#<CR>
	Write	Color space RGB-PC	<CR>*cs=rgbp#<CR>
	Write	Color space RGB-Video	<CR>*cs=rgbv#<CR>

<b>Display</b>	Read	Current color space	<CR>*cs=?#<CR>
	Write	Reset display	<CR>*display=reset#<CR>
<b>Display : 3D &amp; PIP</b>	Write	3D Sync Off	<CR>*3d=off#<CR>
	Write	3D Auto	<CR>*3d=auto#<CR>
	Write	3D Sync Side by Side	<CR>*3d=sbs#<CR>
	Write	3D Sync Top Bottom	<CR>*3d=tb#<CR>
<b>Display : 3D &amp; PIP</b>	Write	3D Sync Frame Sequential	<CR>*3d=fs#<CR>
	Write	3D inverter disable(3D Swap=Normal)	<CR>*3d=da#<CR>
	Write	3D inverter (3D Swap=Reverse)	<CR>*3d=iv#<CR>
	Read	3D Sync Status	<CR>*3d=?#<CR>
	Write	PIP mode On	<CR>*pip=on#<CR>
	Write	PIP mode Off	<CR>*pip=off#<CR>
	Write	PIP HDMI	<CR>*psour=hdm#<CR>
	Write	PIP DVI-D (DVI)	<CR>*psour=dvid#<CR>
	Write	PIP COMPUTER/YPbPr(VGA)	<CR>*psour=RGB#<CR>
	Write	PIP COMPUTER 2/YPbPr2(BNC)	<CR>*psour=RGB2#<CR>
	Write	PIP DisplayPort	<CR>*psour=dp#<CR>
	Write	PIP 3G-SDI	<CR>*psour=sdi#<CR>
	Write	PIP HDBaseT	<CR>*psour=hdbaset#<CR>
	Read	Current PIP source	<CR>*psour=?#<CR>
	Write	PIP position Top Left	<CR>*pippos=tl#<CR>
	Write	PIP position Top Right	<CR>*pippos=tr#<CR>
	Write	PIP position Bottom Left	<CR>*pippos=bl#<CR>
	Write	PIP position Bottom Right	<CR>*pippos=br#<CR>
	Write	PIP position PBP	<CR>*pippos=pbp#<CR>
	Read	Current PIP position	<CR>*pippos=?#<CR>
<b>Setup</b>	Write	Set language to English	<CR>*lang=EN#<CR>
	Write	Set language to French	<CR>*lang=FR#<CR>
	Write	Set language to Spanish	<CR>*lang=SP#<CR>
	Write	Set language to German	<CR>*lang=GE#<CR>
	Write	Set language to Simplify Chinese	<CR>*lang=SC#<CR>
	Read	language status	<CR>*lang=?#<CR>
	Write	Projector Position-Front Table	<CR>*pp=FT#<CR>
	Write	Projector Position-Rear Table	<CR>*pp=RE#<CR>
	Write	Projector Position-Rear Ceiling	<CR>*pp=RC#<CR>
	Write	Projector Position-Front Ceiling	<CR>*pp=FC#<CR>
	Read	Projector Position Status	<CR>*pp=?#<CR>
	Write	Quick auto search on(Auto Search On)	<CR>*QAS=on#<CR>
	Write	Quick auto search off (Auto Search Off)	<CR>*QAS=off#<CR>
	Read	Quick auto search status	<CR>*QAS=?#<CR>

<b>Setup</b>	Write	Set test pattern Off	<CR>*tp=off#<CR>
	Write	Set test pattern White	<CR>*tp=white#<CR>
	Write	Set test pattern Black	<CR>*tp=black#<CR>
	Write	Set test pattern Red	<CR>*tp=red#<CR>
	Write	Set test pattern Green	<CR>*tp=green#<CR>
<b>Setup</b>	Write	Set test pattern Blue	<CR>*tp=blue#<CR>
	Write	Set test pattern Checkerboard	<CR>*tp=checker#<CR>
	Write	Set test pattern CrossHatch	<CR>*tp=crosshatch#<CR>
	Write	Set test pattern V Burst	<CR>*tp=vburst#<CR>
	Write	Set test pattern H Burst	<CR>*tp=hbust#<CR>
	Write	Set test pattern ColorBar	<CR>*tp=colorbar#<CR>
	Read	Get test pattern status	<CR>*tp=?#<CR>
	Write	Reset Setup	<CR>*setup=reset#<CR>
<b>Light Settings</b>	Write	Laser power Normal mode	<CR>*lsrpm=lnor#<CR>
	Write	Laser power Eco mode	<CR>*lsrpm=eco#<CR>
	Write	Laser power Custom mode	<CR>*lsrpm=custo#<CR>
	Read	Get laser power mode	<CR>*lsrpm=?#<CR>
	Write	Custom power level +	<CR>*lsrcl=+#<CR>
	Write	Custom power level -	<CR>*lsrcl=-#<CR>
	Read	Custom power level ?	<CR>*lsrcl=?#<CR>
	Write	High Altitude mode on	<CR>*Highaltitude=on#<CR>
	Write	High Altitude mode auto	<CR>*Highaltitude=auto#<CR>
	Read	High Altitude mode status	<CR>*Highaltitude=?#<CR>
<b>Warping</b>	Write	Set Active Warp to Keystone	<CR>*warp=keystone#<CR>
	Write	Set Active Warp to 4 Corners	<CR>*warp=4corners#<CR>
	Write	Set Active Warp to Rotation	<CR>*warp=rotation#<CR>
	Write	Set Active Warp to Pin/Barrel	<CR>*warp=pinbarrel#<CR>
	Read	Active Warp Status	<CR>*warp=?#<CR>
	Write	Warp Reset	<CR>*warp=reset#<CR>
	Write	Keystone-Horizontal Decrease	<CR>*hkeyst=-#<CR>
	Write	Keystone-Horizontal Increase	<CR>*hkeyst=+#<CR>
	Read	Keystone-Horizontal Status	<CR>*hkeyst=?#<CR>
	Write	Keystone-Vertical Decrease	<CR>*vkeyst=-#<CR>
	Write	Keystone-Vertical Increase	<CR>*vkeyst=+#<CR>
	Read	Keystone-Vertical Status	<CR>*vkeyst=?#<CR>
	Write	Rotation Decrease	<CR>*rot=-#<CR>
	Write	Rotation Increase	<CR>*rot=+#<CR>
	Read	Rotation Status	<CR>*rot=?#<CR>
	Write	Horizontal Pin/Barrel Decrease	<CR>*hpinba=-#<CR>
	Write	Horizontal Pin/Barrel Increase	<CR>*hpinba=+#<CR>
	Read	Horizontal Pin/Barrel Status	<CR>*hpinba=?#<CR>
	Write	Vertical Pin/Barrel Decrease	<CR>*vpinba=-#<CR>

<b>Warping</b>	Write	Vertical Pin/Barrel Increase	<CR>*vpinba=+#<CR>
	Read	Vertical Pin/Barrel Status	<CR>*vpinba=?#<CR>
	Write	4 Corners Top-Left-X Decrease	<CR>*4ctlx=-#<CR>
	Write	4 Corners Top-Left-X Increase	<CR>*4ctlx=+#<CR>
	Read	4 Corners Top-Left-X Status	<CR>*4ctlx=?#<CR>
<b>Warping</b>	Write	4 Corners Top-Left-Y Decrease	<CR>*4ctly=-#<CR>
	Write	4 Corners Top-Left-Y Increase	<CR>*4ctly=+#<CR>
	Read	4 Corners Top-Left-Y Status	<CR>*4ctly=?#<CR>
	Write	4 Corners Top-Right-X Decrease	<CR>*4ctrx=-#<CR>
	Write	4 Corners Top-Right-X Increase	<CR>*4ctrx=+#<CR>
	Read	4 Corners Top-Right-X Status	<CR>*4ctrx=?#<CR>
	Write	4 Corners Top-Right-Y Decrease	<CR>*4ctry=-#<CR>
	Write	4 Corners Top-Right-Y Increase	<CR>*4ctry=+#<CR>
	Read	4 Corners Top-Right-Y Status	<CR>*4ctry=?#<CR>
	Write	4 Corners Bottom-Left-X Decrease	<CR>*4cblx=-#<CR>
	Write	4 Corners Bottom-Left-X Increase	<CR>*4cblx=+#<CR>
	Read	4 Corners Bottom-Left-X Status	<CR>*4cblx=?#<CR>
	Write	4 Corners Bottom-Left-Y Decrease	<CR>*4cbly=-#<CR>
	Write	4 Corners Bottom-Left-Y Increase	<CR>*4cbly=+#<CR>
	Read	4 Corners Bottom-Left-Y Status	<CR>*4cbly=?#<CR>
	Write	4 Corners Bottom-Right-X Decrease	<CR>*4cbrx=-#<CR>
	Write	4 Corners Bottom-Right-X Increase	<CR>*4cbrx=+#<CR>
	Read	4 Corners Bottom-Right-X Status	<CR>*4cbrx=?#<CR>
	Write	4 Corners Bottom-Right-Y Decrease	<CR>*4cbry=-#<CR>
	Write	4 Corners Bottom-Right-Y Increase	<CR>*4cbry=+#<CR>
Read	4 Corners Bottom-Right-Y Status	<CR>*4cbry=?#<CR>	
<b>Blanking</b>	Write	Blanking Reset	<CR>*bnk=reset#<CR>
	Write	Blanking Top Decrease	<CR>*bnkt=-#<CR>
	Write	Blanking Top Increase	<CR>*bnkt=+#<CR>
	Read	Blanking Top Status	<CR>*bnkt=?#<CR>
	Write	Blanking Bottom Decrease	<CR>*bnkb=-#<CR>
	Write	Blanking Bottom Increase	<CR>*bnkb=+#<CR>
	Read	Blanking Bottom Status	<CR>*bnkb=?#<CR>
	Write	Blanking Left Decrease	<CR>*bnkl=-#<CR>
	Write	Blanking Left Increase	<CR>*bnkl=+#<CR>
	Read	Blanking Left Status	<CR>*bnkl=?#<CR>
	Write	Blanking Right Decrease	<CR>*bnkr=-#<CR>
	Write	Blanking Right Increase	<CR>*bnkr=+#<CR>
	Read	Blanking Right Status	<CR>*bnkr=?#<CR>

<b>Edge Blending</b>	Write	Edge Blending On	<CR>*eb=on#<CR>
	Write	Edge Blending Off	<CR>*eb=off#<CR>
	Read	Edge Blending Status	<CR>*eb=?#<CR>
	Write	Edge Blending Reset	<CR>*eb=reset#<CR>
	Write	Edge Blending adjust lines On	<CR>*ebadl=on#<CR>
<b>Edge Blending</b>	Write	Edge Blending adjust lines Off	<CR>*ebadl=off#<CR>
	Read	Edge Blending adjust lines Status	<CR>*ebadl=?#<CR>
	Write	Edge Blending White Level Top Decrease	<CR>*ebwt=-#<CR>
	Write	Edge Blending White Level Top Increase	<CR>*ebwt=+#<CR>
	Read	Edge Blending White Level Top Status	<CR>*ebwt=?#<CR>
	Write	Edge Blending White Level Bottom Decrease	<CR>*ebwb=-#<CR>
	Write	Edge Blending White Level Bottom Increase	<CR>*ebwb=+#<CR>
	Read	Edge Blending White Level Bottom Status	<CR>*ebwb=?#<CR>
	Write	Edge Blending White Level Left Decrease	<CR>*ebwl=-#<CR>
	Write	Edge Blending White Level Left Increase	<CR>*ebwl=+#<CR>
	Read	Edge Blending White Level Left Status	<CR>*ebwl=?#<CR>
	Write	Edge Blending White Level Right Decrease	<CR>*ebwr=-#<CR>
	Write	Edge Blending White Level Right Increase	<CR>*ebwr=+#<CR>
	Read	Edge Blending White Level Right Status	<CR>*ebwr=?#<CR>
	Write	Edge Blending Black Level Top Decrease	<CR>*ebbt=-#<CR>
	Write	Edge Blending Black Level Top Increase	<CR>*ebbt=+#<CR>
	Read	Edge Blending Black Level Top Status	<CR>*ebbt=?#<CR>
	Write	Edge Blending Black Level Bottom Decrease	<CR>*ebbb=-#<CR>
	Write	Edge Blending Black Level Bottom Increase	<CR>*ebbb=+#<CR>
	Read	Edge Blending Black Level Bottom Status	<CR>*ebbb=?#<CR>
	Write	Edge Blending Black Level Left Decrease	<CR>*ebbl=-#<CR>
	Write	Edge Blending Black Level Left Increase	<CR>*ebbl=+#<CR>
	Read	Edge Blending Black Level Left Status	<CR>*ebbl=?#<CR>
	Write	Edge Blending Black Level Right Decrease	<CR>*ebbr=-#<CR>
	Write	Edge Blending Black Level Right Increase	<CR>*ebbr=+#<CR>
	Read	Edge Blending Black Level Right Status	<CR>*ebbr=?#<CR>



Edge Blending	Write	Edge Blending Black Level All color Decrease	<CR>*ebca=-#<CR>
	Write	Edge Blending Black Level All color Increase	<CR>*ebca=+#<CR>
	Read	Edge Blending Black Level All color Status	<CR>*ebca=?#<CR>
	Write	Edge Blending Black Level Red Decrease	<CR>*ebcr=-#<CR>
	Write	Edge Blending Black Level Red Increase	<CR>*ebcr=+#<CR>
	Read	Edge Blending Black Level Red Status	<CR>*ebcr=?#<CR>
	Write	Edge Blending Black Level Green Decrease	<CR>*ebcg=-#<CR>
	Write	Edge Blending Black Level Green Increase	<CR>*ebcg=+#<CR>
	Read	Edge Blending Black Level Green Status	<CR>*ebcg=?#<CR>
	Write	Edge Blending Black Level Blue Decrease	<CR>*ebcb=-#<CR>
	Write	Edge Blending Black Level Blue Increase	<CR>*ebcb=+#<CR>
	Read	Edge Blending Black Level Blue Status	<CR>*ebcb=?#<CR>
	System	Write	Standby Settings-Network on (Network Standby)
Write		Standby Settings-Network off (ECO Standby)	<CR>*standbynet=off#<CR>
Read		Standby Settings-Network Status	<CR>*standbynet=?#<CR>
Write		Auto Power Off-on(Auto power off)	<CR>*autopoweroff=on#<CR>
Write		Auto Power Off-off(Auto power off)	<CR>*autopoweroff=off#<CR>
Read		Auto Power Off-Status	<CR>*autopoweroff=?#<CR>
Write		Direct Power On-on(Auto Power On )	<CR>*directpower=on#<CR>
Write		Direct Power On-off(Auto power off)	<CR>*directpower=off#<CR>
Read		Direct Power On-Status	<CR>*directpower=?#<CR>
Write		Set background to Logo	<CR>*bg=logo#<CR>
Write		Set background to Black	<CR>*bg=black#<CR>
Write		Set background to Blue	<CR>*bg=blue#<CR>
Write		Set background to White	<CR>*bg=white#<CR>
Read		Get background status	<CR>*bg=?#<CR>
Write		Startup logo off	<CR>*startlogo=off#<CR>
Write		Startup logo on	<CR>*startlogo=on#<CR>
Write		Get startup logo status	<CR>*startlogo=#<CR>
Write		Trigger on	<CR>*trigger=on#<CR>
Write		Trigger off	<CR>*trigger=off#<CR>
Read		Trigger status	<CR>*trigger=?#<CR>
Write		Dynamic black on	<CR>*db=on#<CR>
Write		Dynamic blackoff	<CR>*db=off#<CR>

<b>System</b>	Read	Dynamic black status	<CR>*db=?#<CR>
	Write	Factory reset	<CR>*fact=reset#<CR>
	Write	System reset	<CR>*system=reset#<CR>
<b>Information</b>	Read	Get Model Name	<CR>*modelname=?#<CR>
<b>Information</b>	Read	Get Serial Number	<CR>*sn=?#<CR>
	Read	Get F/W Version	<CR>*swver=?#<CR>
	Read	Get Active source	<CR>*activesour=?#<CR>
	Read	Get Pixel clock	<CR>*pixelclock=?#<CR>
	Read	Get Signal format	<CR>*signal=?#<CR>
	Read	Get H refresh rate	<CR>*hfreq=?#<CR>
	Read	Get V refresh rate	<CR>*vfreq=?#<CR>
	Read	Laser Hour	<CR>*lsrtim=?#<CR>
<b>Miscellaneous</b>	Write	Blank On	<CR>*blank=on#<CR>
	Write	Blank Off	<CR>*blank=off#<CR>
	Read	Blank Status	<CR>*blank=?#<CR>
	Write	Freeze On	<CR>*freeze=on#<CR>
	Write	Freeze Off	<CR>*freeze=off#<CR>
	Read	Freeze Status	<CR>*freeze=?#<CR>
	Write	Menu On	<CR>*menu=on#<CR>
	Write	Menu Off	<CR>*menu=off#<CR>
	Read	Menu Status	<CR>*menu=?#<CR>
	Write	Up	<CR>*up#<CR>
	Write	Down	<CR>*down#<CR>
	Write	Right	<CR>*right#<CR>
	Write	Left	<CR>*left#<CR>
	Write	Enter	<CR>*enter#<CR>
	Read	Error Code	<CR>*error=report#<CR>
	Write	Lens Shift Up	<CR>*lst=up#<CR>
	Write	Lens Shift Down	<CR>*lst=down#<CR>
	Write	Lens Shift Left	<CR>*lst=left#<CR>
	Write	Lens Shift Right	<CR>*lst=right#<CR>
	Write	Lens Focus Plus	<CR>*focus=+#<CR>
	Write	Lens Focus Minus	<CR>*focus=-#<CR>
	Write	Lens Zoom Plus	<CR>*zoom=+#<CR>
Write	Lens Zoom Minus	<CR>*zoom=-#<CR>	

**Note:**

RS-232 Baud rate:9600

# Control the projector through network

## Set up the projector for networking

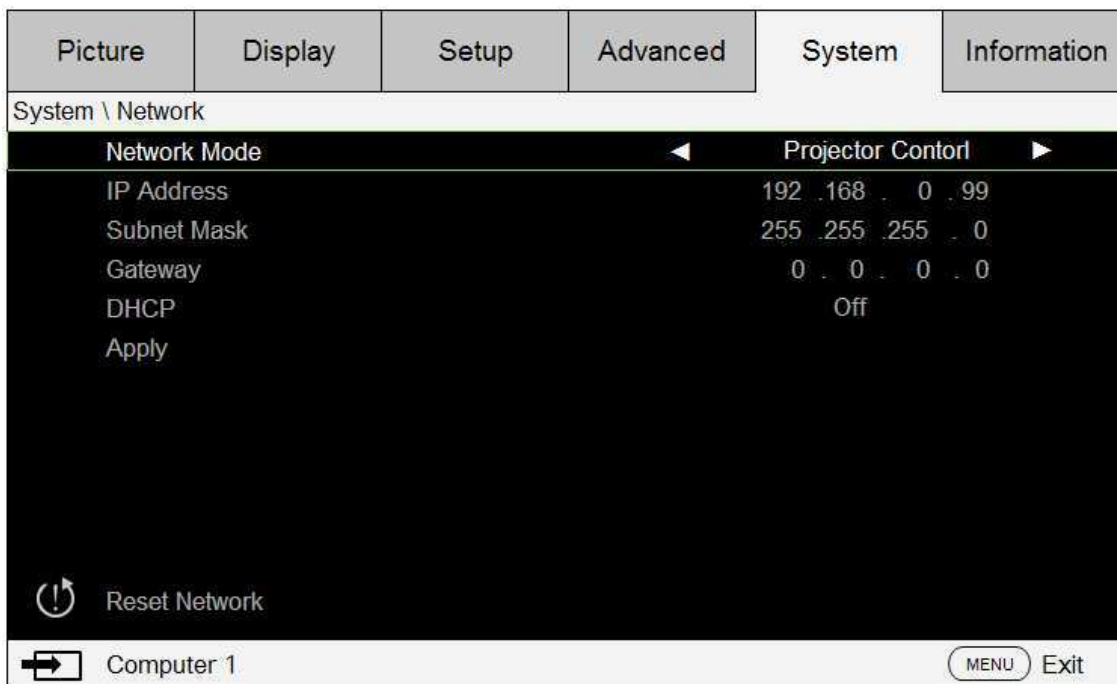

### Caution:

Please set DHCP option to Off and select Apply to activate it. The DHCP service assigns an IP address and settings. The IP address, Subnet and Gateway options will be dimmed and not available for selection. If the LAN does not support DHCP service, please press ▲▼ and Enter key to select network and its settings:

**IP Address:** To specify an IP address, press the Enter button to show the IP address input window. Use the ◀▶ buttons to select the number in the IP address to be changed. Use the ▲▼ buttons to increase or decrease the number in the IP address.

**Subnet Mask:** Set up the subnet address in the same way as for the IP Address setup.

**Gateway:** Set up the gateway address in the same way as for the IP Address setup.

**DHCP:** Set DHCP to On or Off. If this is set to On, the DHCP server of network domain will assign an IP address to the projector. That is, the IP address will display in the address window instead of having to be manually entered. Otherwise, the domain does not or cannot assign an IP address, and 0.0.0.0 is shown on the IP address window.

**Apply:** Select this button and press Enter. It takes the projector several seconds to execute the change in network setting until the following message disappears.

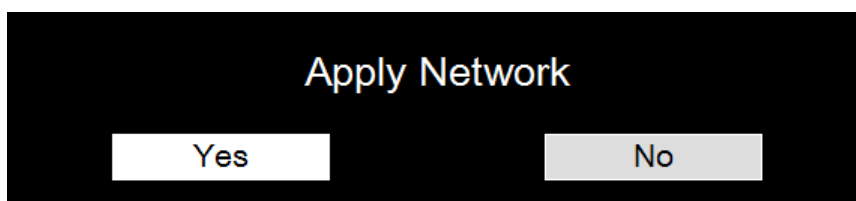

Please contact your network administrator if the network remains disconnected.

## Control the projector through web browser

Open a web browser and enter the projector's IP address. Its home page with four options will display:

**Projector Status:** Current projector settings.

**Alert Mail Setup:** Settings for projector abnormality email reminders. In case of any abnormality the projector sends emails to preset users.

**Crestron:** Crestron compatible network browser control page.

**PJLink:** This page lets you set up a security password for PJLink connection.

## Projector status

The following illustrates a projector with IP address "192.168.0.100":

<b>Projector Status</b>	Model		BenQ Projector	
<b>Projector Control</b>	Serial Number		9876543219876	
<b>Crestron RoomView</b>	Software Version		MD07-SD07-FD17-LD03-22-RD02-3092	
<b>Network Setup</b>	Power Status		Power On	
<b>Alert Mail Setup</b>	Input		COMPUTER1	
	Laser Status		Power : On	Runtime : 267 H
	Projection Mode		Front Table	
	High Altitude		Auto	
	Intake Temperature		28 / 30	°C
	DMD Temperature		34	°C
	Laser Temperature		46 / 41	°C
	Diagnostic Status		(No Error)	
	<b>LAN Information</b>			
	LAN Software Ver.		RD02	
	MAC address		00:18:23:00:00:00	

Model	: Model number of the projector
Software Version	: Version of projector system software
Power Status	: Current projector power on status
Input	: Current input signal
Diagnostic status	: Display projector error messages

Network control setup information (RJ-45 Version)

LAN Software Version	: Version of network control software
MAC address	: Current IP address

## Projector control

Choose this function to control the projector via the web.

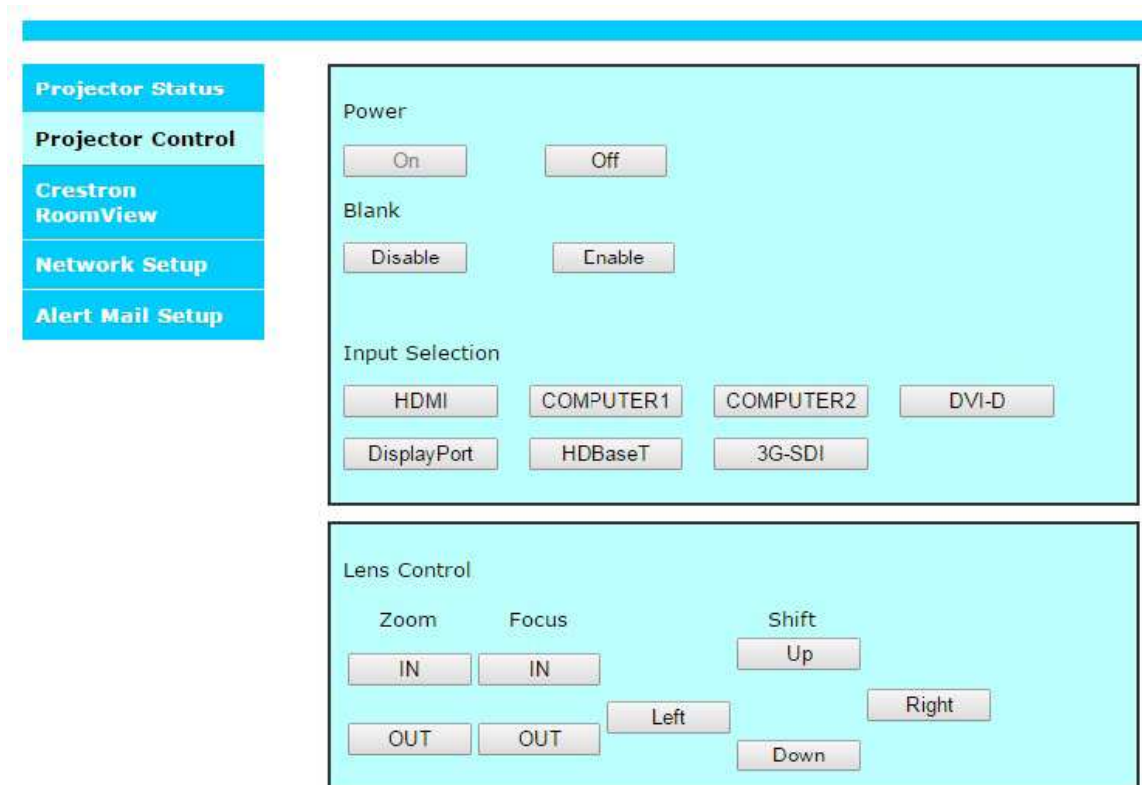

## Crestron RoomView

Click the Crestron option in your projector's home page to display its control page in a new tab.



**Power:** Press to power on or off your projector.

**Source List:** Switch among list of available projector input signal sources. Press the ▲ (at top of screen) or ▼ (at bottom of screen) arrow key to scroll through the list.

Image adjust options

Press the ◀ (to the left of screen) or ▶ (to the right of screen) arrow key to scroll through other adjustment options.

**Freeze:** Freeze current projection screen. The projection screen prompts "Freeze" message once the freeze function is enabled. Press the Freeze button again to unfreeze the image.

**Contrast:** Press to display the adjustment window, click ◀▶ arrow key to adjust contrast.

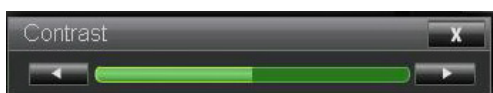

**Brightness:** Press to display the adjustment window, click ◀▶ arrow key with the mouse to adjust brightness.

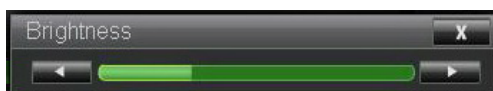

**Sharpness:** Press to display the adjustment window, click ◀▶ arrow key with the mouse to adjust sharpness.

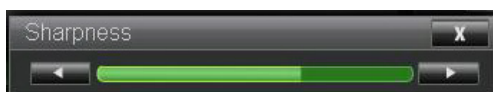

**Zoom:** Zoom in on the projection image. Click "+" key to zoom in and "-" to zoom out. Click the four arrow keys in the window to move the zoomed projection image.

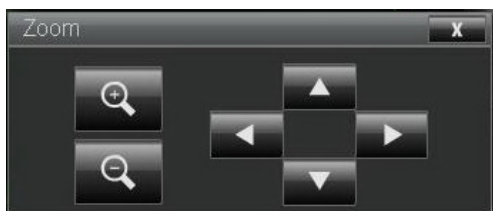

Control key window

This window simulates keys on the remote controller and control panel.

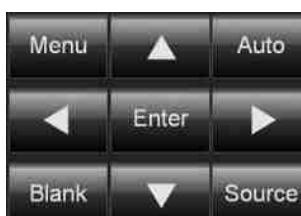

Enter: Confirm the changes and select the OSD option

Menu: Press to display the OSD menu. Press again to exit it.

Auto: Execute the auto image adjustment function.

Blank: Pause the image projection, i.e. the projection image is masked. Press again to resume the projection.

Source: Display list of signal sources.

**Tools:** Set up options to work with Creston compatible devices. See relevant manuals for detailed setup steps.

**Info:** Display current projector status and Creston settings.

## Network setup

Control your projector with following setup.

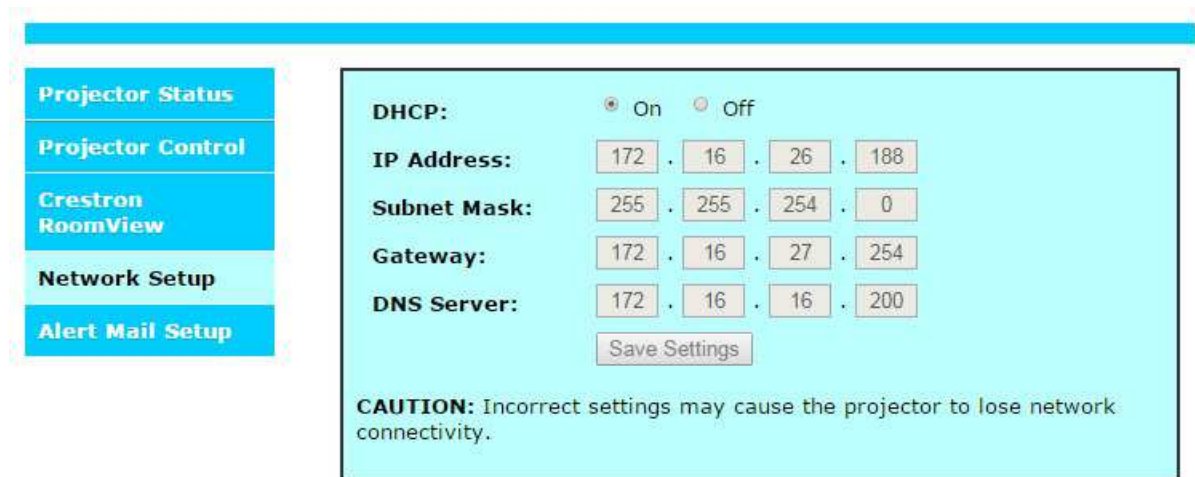

**Projector Status**

**Projector Control**

**Crestron RoomView**

**Network Setup**

**Alert Mail Setup**

**DHCP:**  On  Off

**IP Address:** 172 . 16 . 26 . 188

**Subnet Mask:** 255 . 255 . 254 . 0

**Gateway:** 172 . 16 . 27 . 254

**DNS Server:** 172 . 16 . 16 . 200

Save Settings

**CAUTION:** Incorrect settings may cause the projector to lose network connectivity.

Network control setup information

IP Address : Current IP address  
 Subnet Mask : Current subnet setting  
 Gateway : Current gateway setting  
 DNS Server : Current DNS server setting

## Alert mail setup

The projector can send alert messages with Email to predefined users. Make the following settings.

Before enabling this function:

- SMTP Sever : Set up name of SMTP server for the projector's sending reminder E-mail Port.
- E-mail Port : Set up transmission port.
- User Name : Set up user name for the projector's sending reminder email through SMTP server.
- Password : Set up user password.
- E-mail Alert : Enable or disable E-mail Alert function.
- From : Set up sender's email address.
- To : Set up recipient's email address.
- CC : Set up CC recipient's email address.
- Projector Name : Set up projector name or ID.
- Location : Set up installation location of projector.



# Troubleshooting

## Indicator messages

Several indicator messages are used by the projector to alert users about problems with setup or system error. The LEDs on top cover of the projector illustrated below.

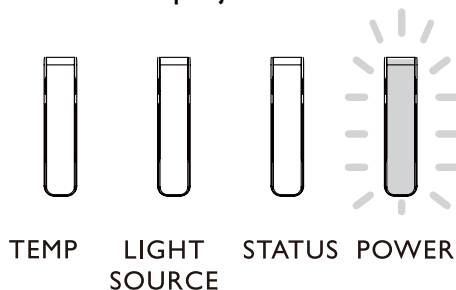

### TEMP LED

LED display		Projector status	Operation tips
Off		Normal status	
Flashing	Red	Over temperature error	Contact with your nearest authorized dealer or service center.

### LIGHT SOURCE LED

LED display		Projector status	Operation tips
Off		Light source is off	
Flashing	Green	Projector is turning on	
	Red (Cycles of 6)	Light source is end-of-life	Please call the local service center.
On	Red	Light source problem	Please call the local service center.
	Green	Light source is on	

### STATUS LED indicator

LED display		Projector status	Operation tips
Close		Normal	
Flashing	Red (once)	Safety switch error	Please check whether the top cover is well assembled or lens is well installed or not. If the problem persists, call the local service center.
	Red (quadruple)	Fan error	Call the local service center.
Lights up	Red	System error	Call the local service center.

### POWER LED indicator

LED display		Projector status	Operation tips
Close		AC power turned off	Check AC power source and power on the projector.
Flashing	Green	Ready to power on the projector	Wait until the projector starts projecting.
	Orange	The projector is cooling down	
Lights up	Red	Standby mode	To power on the projector, press the ON key on the remote controller or the Power key on the control panel.
	Green	Projector powered on	

## Common problems and solutions

These guidelines provide tips to deal with problems you may encounter while using the projector. If the problem remains unsolved, contact your dealer for assistance. Often the problem is something as simple as a loose connection. Check the following before proceeding to the problem-specific solutions.

- Use some other electrical device to confirm that the electrical outlet is working.
- Ensure the projector is turned on.
- Ensure all connections are securely attached.
- Ensure the attached device is turned on.
- Ensure a connected PC is not in suspend mode.
- Ensure a connected notebook computer is configured for an external display. (This is usually done by pressing an Fn-key combination on the notebook.)

## Tips for troubleshooting

In each problem-specific section, try the steps in the order suggested. This may help you to solve the problem more quickly.

Try to pinpoint the problem to avoid replacing non-defective parts.

For example, if you replace batteries and the problem remains, put the original batteries back and go to the next step.

Keep a record of the steps you take when troubleshooting: The information may be useful when calling for technical support or for passing on to service personnel.

## Image problems

Problem: No image appears on the screen

1. Verify the settings on your notebook or desktop PC.
2. Turn off all equipment and power up again in the correct order.

Problem: The image is blurred.

1. Adjust the Focus on the projector.
2. Press the AUTO PC button on the remote control or projector.
3. Ensure the projector-to-screen distance is within the specified range.
4. Check that the projector lens is clean.
5. Remove the lens cover.

Problem: The image is wider at the top or bottom (trapezoid effect)

1. Position the projector so it is as perpendicular to the screen as possible.
2. Use the Keystone function on the OSD to correct the problem.

Problem: The image is reversed or upside down

- Check the Ceiling & Rear setting on the Setting menu of the OSD.

Problem: The image is streaked

1. Adjust the Phase and Clock on the Signal menu of the OSD to the default settings.
2. To ensure the problem is not caused by a connected PC's video card, connect to another computer.

Problem: The image is flat with no contrast

1. Adjust the Contrast setting on the Picture menu of the OSD.
2. Adjust the Brightness setting on the Picture menu of the OSD.

Problem: The color of the projected image does not match the source image.

Adjust the Color temperature and Picture settings.

## Remote control problems

Problem: The projector does not respond to the remote control

1. Direct the remote control towards remote sensor on the projector.
2. Ensure the path between remote and sensor is not obstructed.
3. Turn off any fluorescent lights in the room.
4. Check the battery polarity.
5. Replace the batteries.
6. Turn off other Infrared-enabled devices in the vicinity.
7. Have the remote control serviced.
8. Ensure that the remote control code conforms to the projector's code.
9. Ensure that the reset switch in the compartment lid on back of the remote control is set to use position.

## BenQ ecoFACTS

BenQ has been dedicated to the design and development of greener product as part of its aspiration to realize the ideal of the "Bringing Enjoyment 'N Quality to Life" corporate vision with the ultimate goal to achieve a low-carbon society. Besides meeting international regulatory requirement and standards pertaining to environmental management, BenQ has spared no efforts in pushing our initiatives further to incorporate life cycle design in the aspects of material selection, manufacturing, packaging, transportation, using and disposal of the products. BenQ ecoFACTS label lists key eco-friendly design highlights of each product, hoping to ensure that consumers make informed green choices at purchase. Check out BenQ's CSR Website at <http://csr.BenQ.com/> for more details on BenQ's environmental commitments and achievements.



## Copyright

Copyright 2016 BenQ Corporation. All rights reserved. No part of this publication may be reproduced, transmitted, transcribed, stored in a retrieval system or translated into any language or computer language, in any form or by any means, electronic, mechanical, magnetic, optical, chemical, manual or otherwise, without the prior written permission of BenQ Corporation.

All other logos, products, or company names mentioned in this manual may be the registered trademarks or copyrights of their respective companies, and are used for informational purposes only.

## Disclaimer

BenQ Corporation makes no representations or warranties, either expressed or implied, with respect to the contents hereof and specifically disclaims any warranties, merchantability or fitness for any particular purpose. Further, BenQ Corporation reserves the right to revise this publication and to make changes from time to time in the contents hereof without obligation of BenQ Corporation to notify any person of such revision or changes.

This user manual aims to provide the most updated and accurate information to customers, and thus all contents may be modified from time to time without prior notice. Please visit <http://www.benq.com> for the latest version of this manual.

## Patents

Please go to <http://patmarking.benq.com/> for the details on BenQ projector patent coverage.

## Statement regarding hyperlinks and third-party websites

BenQ is not responsible for the content of the websites or of similar resources, which are maintained and controlled by third parties, that may be linked from this product. Providing links to those websites or to similar resources does not mean that BenQ makes any warranty or representation to their content by expression or by implication.

Any third party content or service preinstalled in this product is provided "as is". BenQ does not, by expression or by implication, make any warrant to the content or to the services provided by third parties. BenQ does not warrant or guarantee that the content or services provided by third parties are accurate, effective, most up-to-date, legal, or complete. Under no circumstances shall BenQ be liable for the content or services provided by third parties including their negligence. Services provided by third parties may be terminated temporarily or permanently. BenQ does not warrant or guarantee that the any content or services provided by third parties are in good condition at any time, and is not liable for the termination of the said content and services. In addition, BenQ is not involved in any transactions you conduct in the websites or similar resources maintained by third parties.

You should contact the content or service providers for any questions, concerns, or disputes.

## About the BENQ Support

### **BenQ Corporation-Headquarters**

16 Jihu Road Neihu, Taipei

114 Taiwan

+886-2-2727-8899

+886-2-2656-2438

### **BenQ Asia Pacific Corp.**

12 Jihu Road Neihu, Taipei

114 Taiwan

+886-2-2727-8899

+886-2-2656-2438

### **BenQ China**

181 Zhuyuan Road, Suzhou New

District, Suzhou, China

+86-512- 68078800

+86-512- 68097010

### **BenQ America Corp.**

3200 Park Center Drive, Suite 150

Costa Mesa, CA 92626 USA

+1-714-559-4900

+1-714-557-0200

### **BenQ Latin America Corp.**

8200 N.W. 33 Street, Suite 301

Miami, FL 33122 USA

+1-305-4211200

+1-305-4211201

### **BenQ Europe B.V.**

Meerenakkerweg 1-17, 5652 AR

Eindhoven, The Netherlands

+31(0)88 888-9200

+31(0)88 888-9299