



LU9235 / LX9215
Digital Projector
Installation Guide



Table of Contents

Notice	3
Laser notice	3
Cooling notice	4
When edge blending.....	4
Product information	5
Packing content.....	5
Specification	5
Terminals	6
Installation	7
Lens	7
Projection table.....	7
Lens shift range	9
Projector dimension	11
Lens dimension.....	12
Remote control	13
RS232 command	14
RS232 pin assignment.....	14

Notice

Laser notice



This symbol indicates that there is a potential hazard of eye exposure to laser radiation unless the instructions are closely followed.

CLASS 3R LASER PRODUCT



This Laser Product is designated as Class 3R during all procedures of operation.

LASER LIGHT - AVOID DIRECT EYE EXPOSURE.

Do not point laser or allow laser light to be directed or reflected toward other people or reflective objects.



Direct or scattered light can be hazardous to eyes and skin.

There is a potential hazard of eye exposure to laser radiation if the included instructions are not followed.

Caution – use of controls or adjustments or performance of procedures other than those specified herein may result in hazardous radiation exposure.

Laser Parameters

Wavelength	450nm - 460nm (Blue)
Mode of operation	Pulsed, due to frame rate
Pulse width	1.34ms
Pulse repetition rate	120Hz
Maximum laser energy	0.698mj
Total internal power	>100w
Apparent source size	>10mm, at lens stop
Divergence	>100 mili Radian

Cooling notice

Ventilation

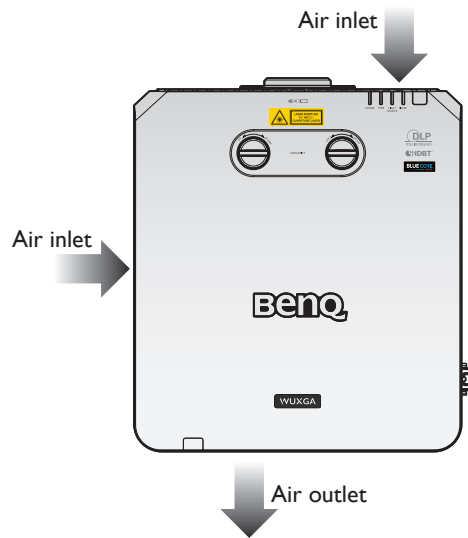

Caution for installation

For proper ventilation of the projector, make sure to leave some space around the projector as shown in the illustration below:

- **Table**

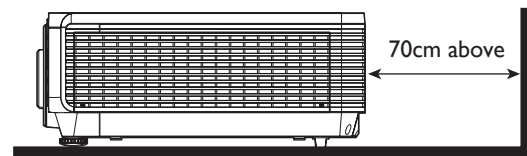
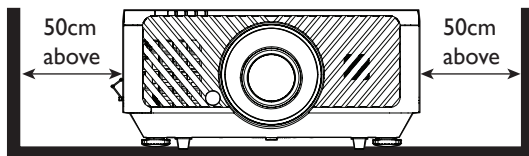

- **Ceiling**

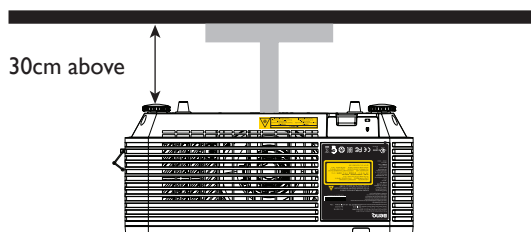

- **Stacking**

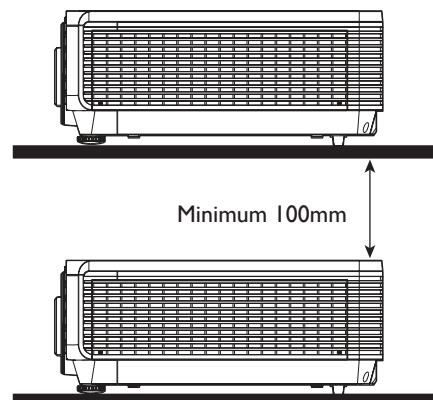

When edge blending

- To avoid the image shaking or some pixels in the display may be misaligned, do not use the projector in the following location:
 - In a building close to a construction site.
 - In a room where an air conditioner unit is working and it vibrates.
 - In a place where the temperature changes dramatically that may cause thermal contraction.
- Before making any adjustment, leave the projector lit for at least 15 minutes after its light source is turned on. This allows the internal temperature of the projector to stabilize.

Product information

Packing content

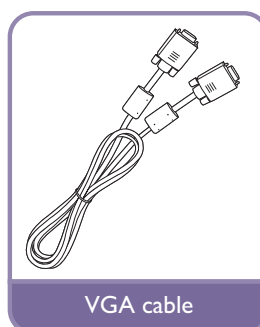
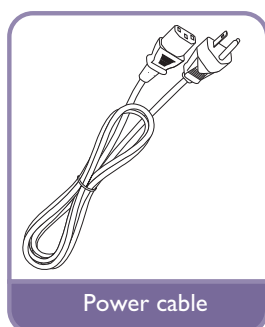
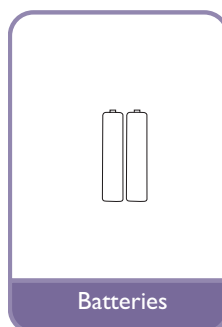
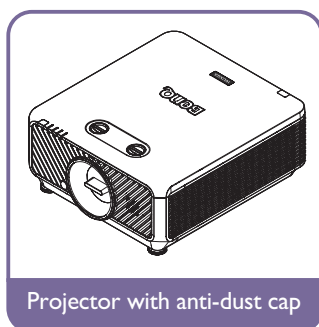

Specification

	LU9235	LX9215
Projection system	DLP Single 0.67 WUXGA DMD Chip	DLP Single 0.7 XGA DMD Chip
Native resolution	1920*1200 pixels, 16:10	1024*768 pixels, 4:3
Brightness	6000 Lumens	6000 Lumens
Light source	Laser diodes	
Power consumption	650Watts (Normal mode)/ 530Watts (Eco mode)	
Dimension	470 x 220.5 x 519.5 mm	
Weight	24 kg (without lens)	

Note:

- The brightness is supplied by standard lens, the value will depends on lenses.
- The brightness output will vary depending on each units and actual usage.

Terminals

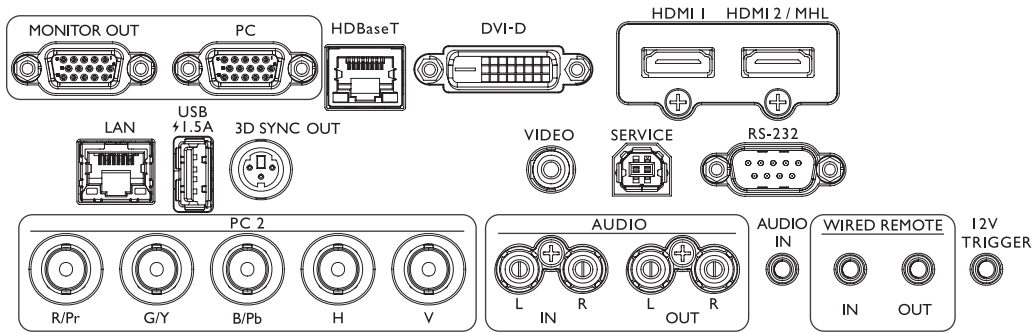

- **MONITOR OUT**
Connection to other display equipment for concurrent playback display.
- **PC**
15-pin VGA port for connection to RGB, component HD source, or PC.
- **HDBaseT**
For connection to RJ45 Cat5/Cat6 cable to input uncompressed high-definition video (HD).
- **DVI-D**
Connection to DVI source.
- **HDMI 1**
Connection to HDMI source.
- **HDMI 2/MHL**
Connection to HDMI or MHL source.
- **LAN**
For connection to RJ45 Cat5/Cat6 Ethernet cable to control the projector through a network.
- **USB 1.5A**
Support 5V/1.5A output.
- **3D SYNC OUT**
Connection to 3D IR sync signal transmitter.
- **VIDEO**
Connection to a video source.
- **SERVICE**
Maintenance exclusive port for authorized maintenance personnel only.
- **RS-232**
Standard 9-pin D-sub interface for connection to PC control system and projector maintenance.
- **PC 2 (R/Pr, G/Y, B/Pb, H, V)**
Connection to RGB or YPbPr/YCbCr output signal with BNC type input terminal.
- **AUDIO IN (L/R)**
Connection to an audio input source via an audio or audio L/R cable.
- **AUDIO OUT (L/R)**
Connection to a speaker or headset.
- **AUDIO IN**
Connection to an audio input source via an audio cable.
- **WIRED REMOTE IN**
Connection to remote control for wire remote control.

Caution:

Make sure the port is valid before inserting a wired remote controller. The remote controller may be damaged in case of an invalid port, e.g. a wired remote controller is connected to trigger output.

- **WIRED REMOTE OUT**
Connection to another projector.
- **12V TRIGGER**
3.5mm mini earphone jack, employs 200mA display relay to provide 12(+/-1.5)V output and short circuit protection.

Installation

Lens

Model	Lens Type	Part Number	Throw Ratio	Lens Shift
LS2ST3	Wide fix	5JJDH37.002	XGA: 0.81 WUXGA: 0.778	Vertical: -15%-55% (WUXGA), -10%-50% (XGA) Horizontal: -5%-5%
LS2ST1	Wide zoom	5JJDH37.011	XGA: 1.14-1.347 WUXGA: 1.1-1.3	Vertical: -15%-55% (WUXGA), -10%-50% (XGA) Horizontal: -5%-5%
LS2SD2	Standard	5JJEN37.001	XGA: 1.6-2 WUXGA: 1.54-1.93	Vertical: -15%-55% (WUXGA), -10%-50% (XGA) Horizontal: -5%-5%
LS2LT1	Semi long	5JJDH37.032	XGA: 2-3 WUXGA: 1.93-2.9	Vertical: -15%-55% (WUXGA), -10%-50% (XGA) Horizontal: -5%-5%
LS2LT2	Long zoom	5JJDH37.041	XGA: 3.11-5.18 WUXGA: 3-5	Vertical: -15%-55% (WUXGA), -10%-50% (XGA) Horizontal: -5%-5%

Projection table

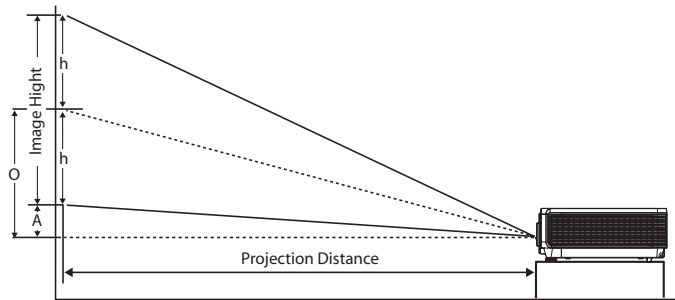
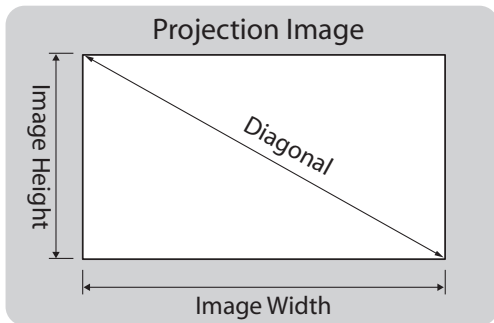

• LX9215

Lens										Wide Zoom (LS2ST1)				Standard (LS2SD2)			
Throw ratio										1.14~1.347				1.6~2			
Diagonal		Image Width		Image Height		Offset (A)		O		Distance				Distance			
						Wide/Tele		Wide/Tele		Wide		Tele		Wide		Tele	
(Inch)	(m)	(Inch)	(m)	(Inch)	(m)	(Inch)	(m)	(Inch)	(m)	(Inch)	(m)	(Inch)	(m)	(Inch)	(m)	(Inch)	(m)
80	2.03	64	1.63	48	1.22	0.0	0.000	24.0	0.610	73	1.85	86	2.19	102	2.60	128	3.25
100	2.54	80	2.03	60	1.52	0.0	0.000	30.0	0.762	91	2.32	108	2.74	128	3.25	160	4.06
120	3.05	96	2.44	72	1.83	0.0	0.000	36.0	0.914	109	2.78	129	3.28	154	3.90	192	4.88
150	3.81	120	3.05	90	2.29	0.0	0.000	45.0	1.143	137	3.47	162	4.11	192	4.88	240	6.10
200	5.08	160	4.06	120	3.05	0.0	0.000	60.0	1.524	182	4.63	216	5.47	256	6.50	320	8.13
300	7.62	240	6.10	180	4.57	0.0	0.000	90.0	2.286	274	6.95	323	8.21	-	-	-	-
400	10.16	320	8.13	240	6.10	0.0	0.000	120.0	3.048	-	-	-	-	-	-	-	-

Lens										Semi Long (LS2LT1)				Long Zoom (LS2LT2)				Wide Fix (LS2ST3)	
Throw ratio										2~3				3.11~5.18				0.81	
Diagonal		Image Width		Image Height		Offset (A)		O		Distance				Distance				Distance	
						Wide/Tele		Wide/Tele		Wide		Tele		Wide		Tele		NA	
(Inch)	(m)	(Inch)	(m)	(Inch)	(m)	(Inch)	(m)	(Inch)	(m)	(Inch)	(m)	(Inch)	(m)	(Inch)	(m)	(Inch)	(m)	(Inch)	(m)
80	2.03	64	1.63	48	1.22	0.0	0.000	24.0	0.610	128	3.25	192	4.88	199	5.06	332	8.42	52	1.32
100	2.54	80	2.03	60	1.52	0.0	0.000	30.0	0.762	160	4.06	240	6.10	249	6.32	414	10.53	65	1.65
120	3.05	96	2.44	72	1.83	0.0	0.000	36.0	0.914	192	4.88	288	7.32	299	7.58	497	12.63	78	1.98
150	3.81	120	3.05	90	2.29	0.0	0.000	45.0	1.143	240	6.10	360	9.14	373	9.48	622	15.79	97	2.47
200	5.08	160	4.06	120	3.05	0.0	0.000	60.0	1.524	320	8.13	480	12.19	498	12.64	829	21.05	130	3.29
300	7.62	240	6.10	180	4.57	0.0	0.000	90.0	2.286	480	12.19	720	18.29	746	18.96	1243	31.58	194	4.94
400	10.16	320	8.13	240	6.10	0.0	0.000	120.0	3.048	640	16.26	960	24.38	-	-	-	-	-	-

• LU9235

Lens										Wide Zoom (LS2ST1)				Standard (LS2SD2)			
Throw ratio										1.1~1.3				1.54~1.93			
Diagonal		Image Width		Image Height		Offset (A)		O		Distance				Distance			
						Wide/Tele		Wide/Tele		Wide		Wide		Wide		Wide	
(Inch)	(m)	(Inch)	(m)	(Inch)	(m)	(Inch)	(m)	(Inch)	(m)	(Inch)	(m)	(Inch)	(m)	(Inch)	(m)	(Inch)	(m)
80	2.03	68	1.72	42	1.08	2.1	0.054	23.3	0.592	75	1.90	88	2.24	104	2.65	131	3.33
100	2.54	85	2.15	53	1.35	2.6	0.067	29.1	0.740	93	2.37	110	2.80	131	3.32	164	4.16
120	3.05	102	2.58	64	1.62	3.2	0.081	35.0	0.888	112	2.84	132	3.36	157	3.98	196	4.99
150	3.81	127	3.23	79	2.02	4.0	0.101	43.7	1.111	140	3.55	165	4.20	196	4.98	245	6.24
200	5.08	170	4.31	106	2.69	5.3	0.135	58.3	1.481	187	4.74	220	5.60	261	6.63	327	8.31
300	7.62	254	6.46	159	4.04	7.9	0.202	87.4	2.221	280	7.11	331	8.40	-	-	-	-
400	10.16	339	8.62	212	5.38	10.6	0.269	116.6	2.962	-	-	-	-	-	-	-	-

Lens										Semi Long (LS2LT1)				Long Zoom (LS2LT2)				Wide Fix (LS2ST3)	
Throw ratio										1.93~2.9				3~5				0.778	
Diagonal		Image Width		Image Height		Offset (A)		O		Distance				Distance				Distance	
						Wide/Tele		Wide/Tele		Wide		Wide		Wide		Wide		NA	
(Inch)	(m)	(Inch)	(m)	(Inch)	(m)	(Inch)	(m)	(Inch)	(m)	(Inch)	(m)	(Inch)	(m)	(Inch)	(m)	(Inch)	(m)	(Inch)	(m)
80	2.03	68	1.72	42	1.08	2.1	0.054	23.3	0.592	131	3.33	197	5.00	204	5.17	339	8.62	53	1.34
100	2.54	85	2.15	53	1.35	2.6	0.067	29.1	0.740	164	4.16	246	6.25	254	6.46	424	10.77	66	1.68
120	3.05	102	2.58	64	1.62	3.2	0.081	35.0	0.888	196	4.99	295	7.50	305	7.75	509	12.92	79	2.01
150	3.81	127	3.23	79	2.02	4.0	0.101	43.7	1.111	245	6.24	369	9.37	382	9.69	636	16.15	99	2.51
200	5.08	170	4.31	106	2.69	5.3	0.135	58.3	1.481	327	8.31	492	12.49	509	12.92	848	21.54	132	3.35
300	7.62	254	6.46	159	4.04	7.9	0.202	87.4	2.221	491	12.47	738	18.74	763	19.39	1272	32.31	-	-
400	10.16	339	8.62	212	5.38	10.6	0.269	116.6	2.962	655	16.63	984	24.99	-	-	-	-	-	-

Note:

- Ceiling installation must be done by a qualified professional. Contact your dealer for more information. It is not recommended you install the projector yourself.
- Only use the projector on a solid, level surface. Serious injury and damage can occur if the projector is dropped.
- Do not use the projector in an environment where extreme temperature occurs. The projector must be used at temperatures between 41 degrees Fahrenheit (5 degrees Celsius) and 104 degrees Fahrenheit (40 degrees Celsius).
- Screen damage will occur if the projector is exposed to moisture, dust or smoke.
- Do not cover the vents on the projector. Proper ventilation is required to dissipate heat. Damage to the projector will occur if the vents are covered.

Lens shift range

Lens shift adjustable range

The adjustable range for lens shift is tabulated below and subject to the conditions listed.

Note:

The drawings below apply to the standard lens only.

• LX9215

Desk-Front Projection

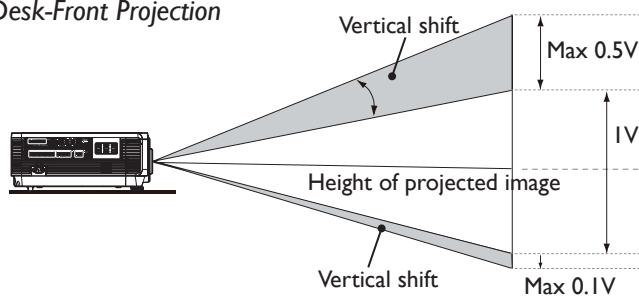

Ceiling Mount-Front Projection

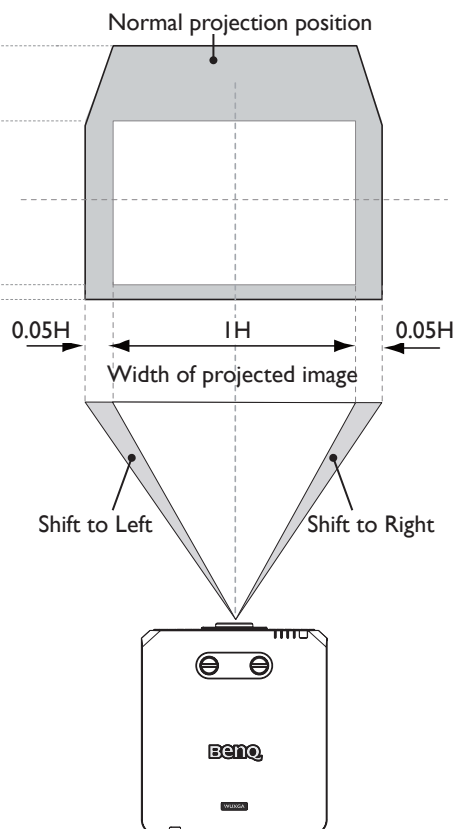
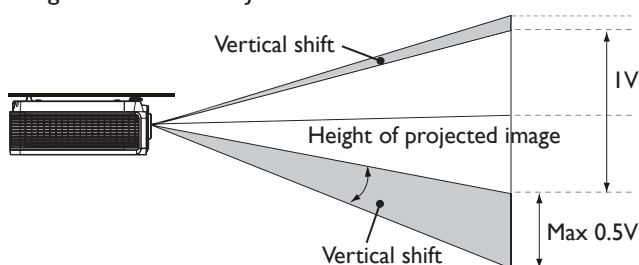

• LU9235

Desk-Front Projection

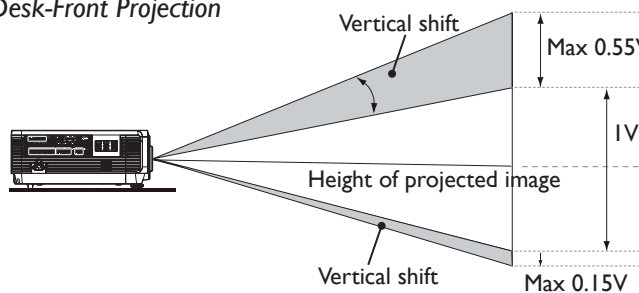

Ceiling Mount-Front Projection

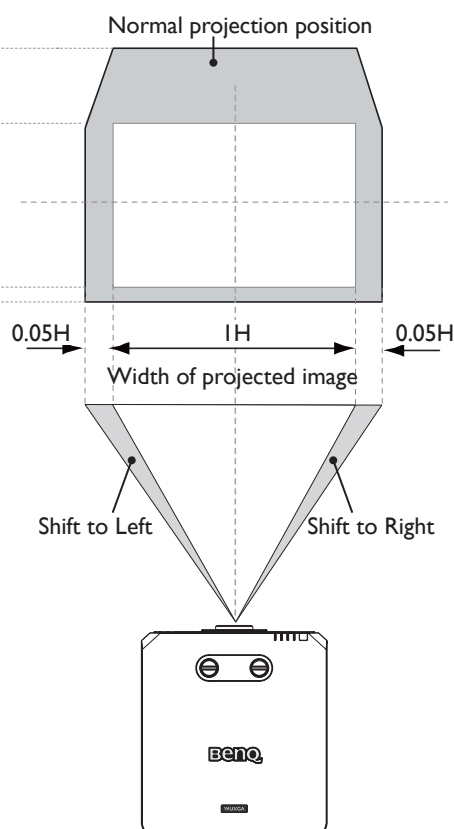
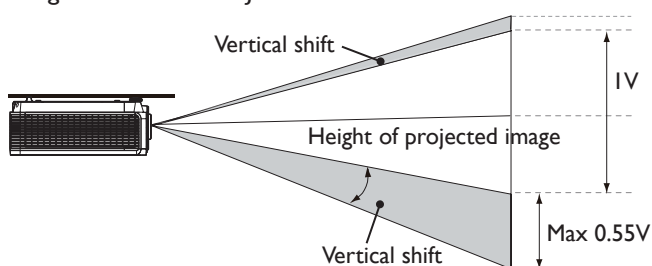

Ceiling Mount Installation

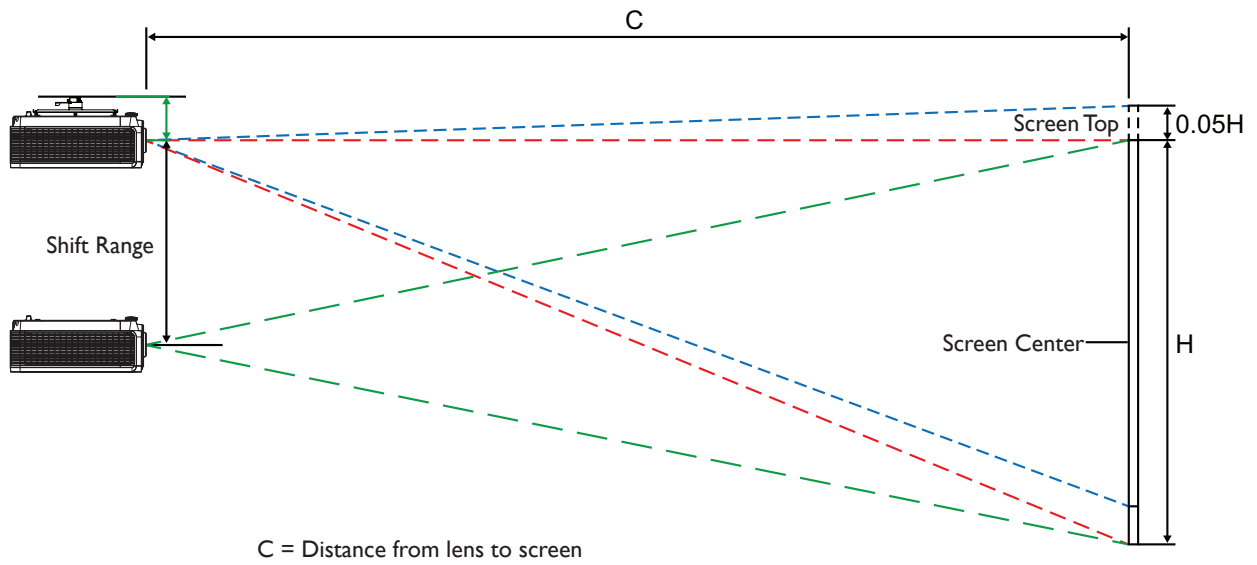

Desktop Installation

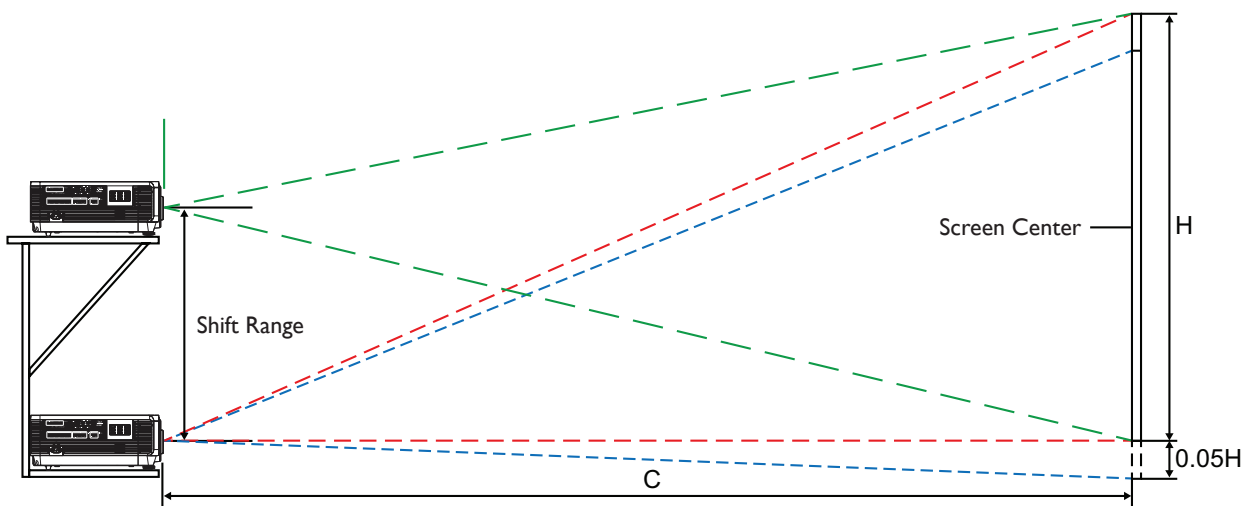

Note:

Lens Shift feature is not available to LS2ST3 (Fix Lens). This lens should be used for "zero degree"/"no-offset" applications. See below:

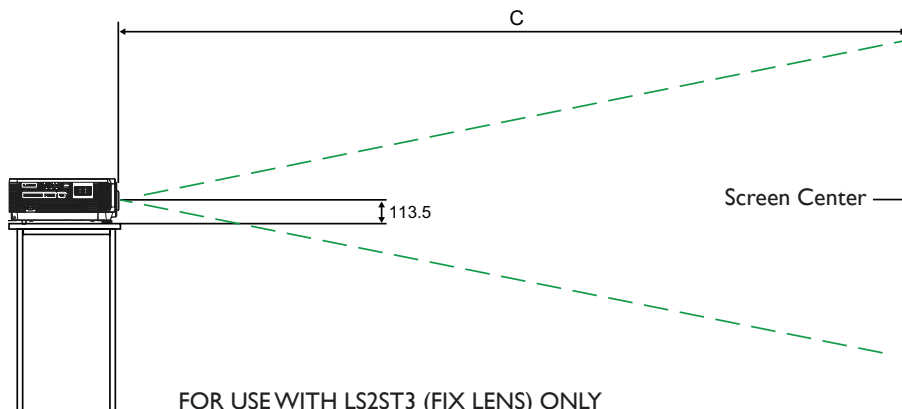

Projector dimension

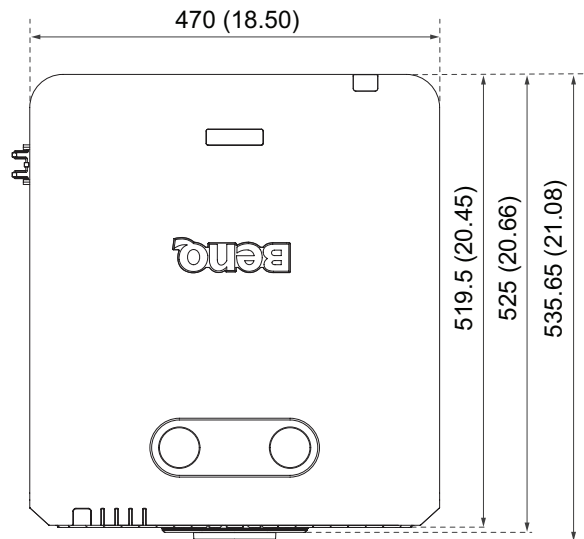
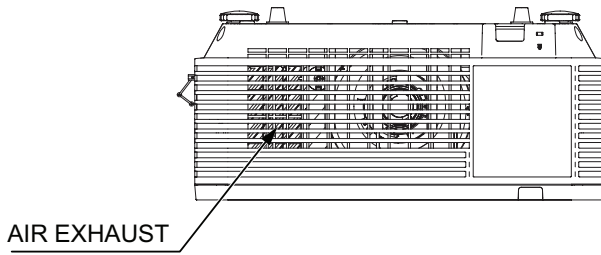
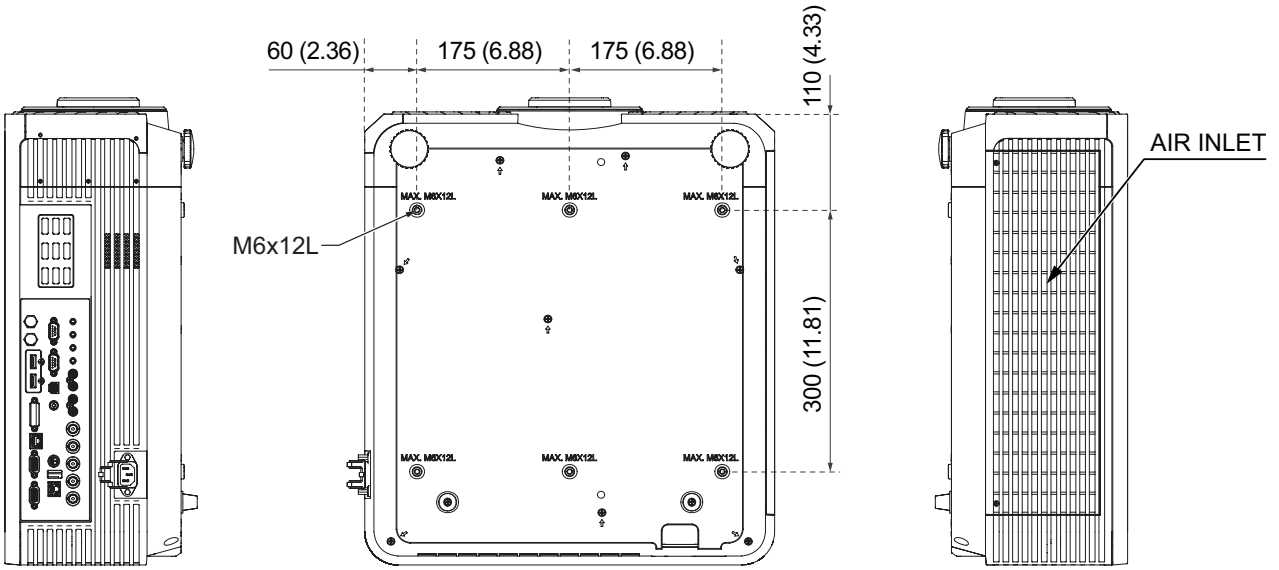
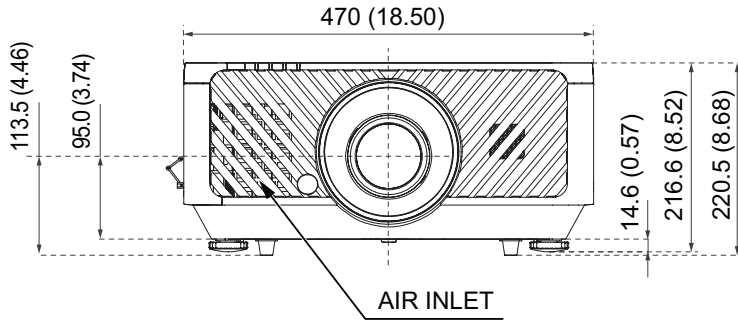

Lens dimension

Optional Lens (Wide Fix: LS2ST3)

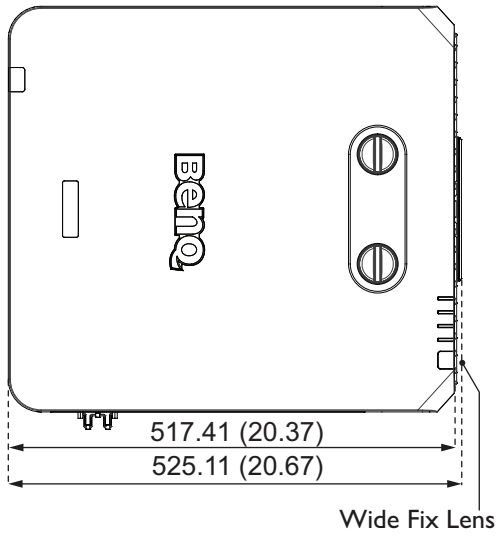

Optional Lens (Wide Zoom: LS2ST1)

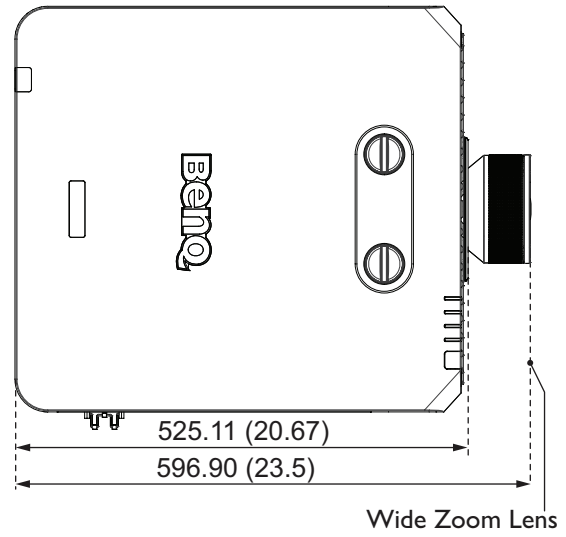

Optional Lens (Standard: LS2SD2)

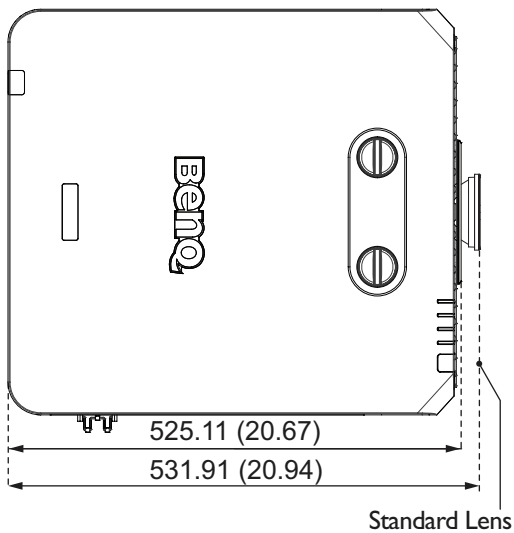

Optional Lens (Semi Long Throw: LS2LT1)

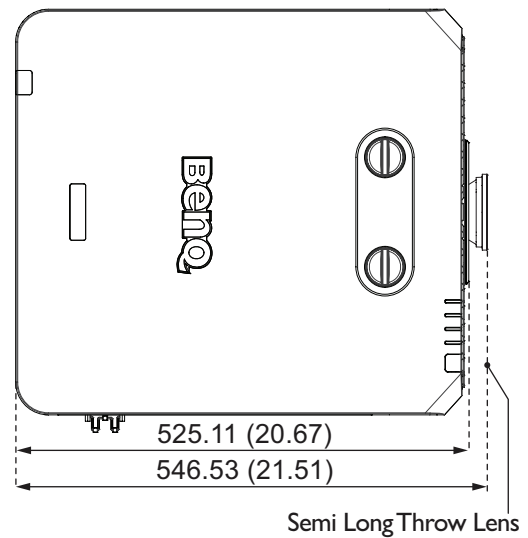

Optional Lens (Long Zoom: LS2LT2)

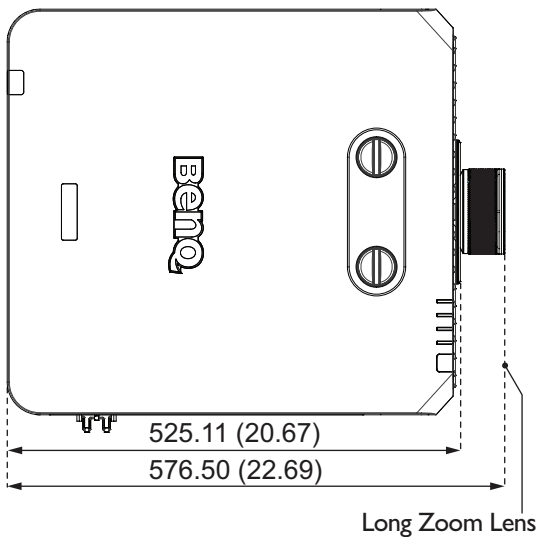

Remote control

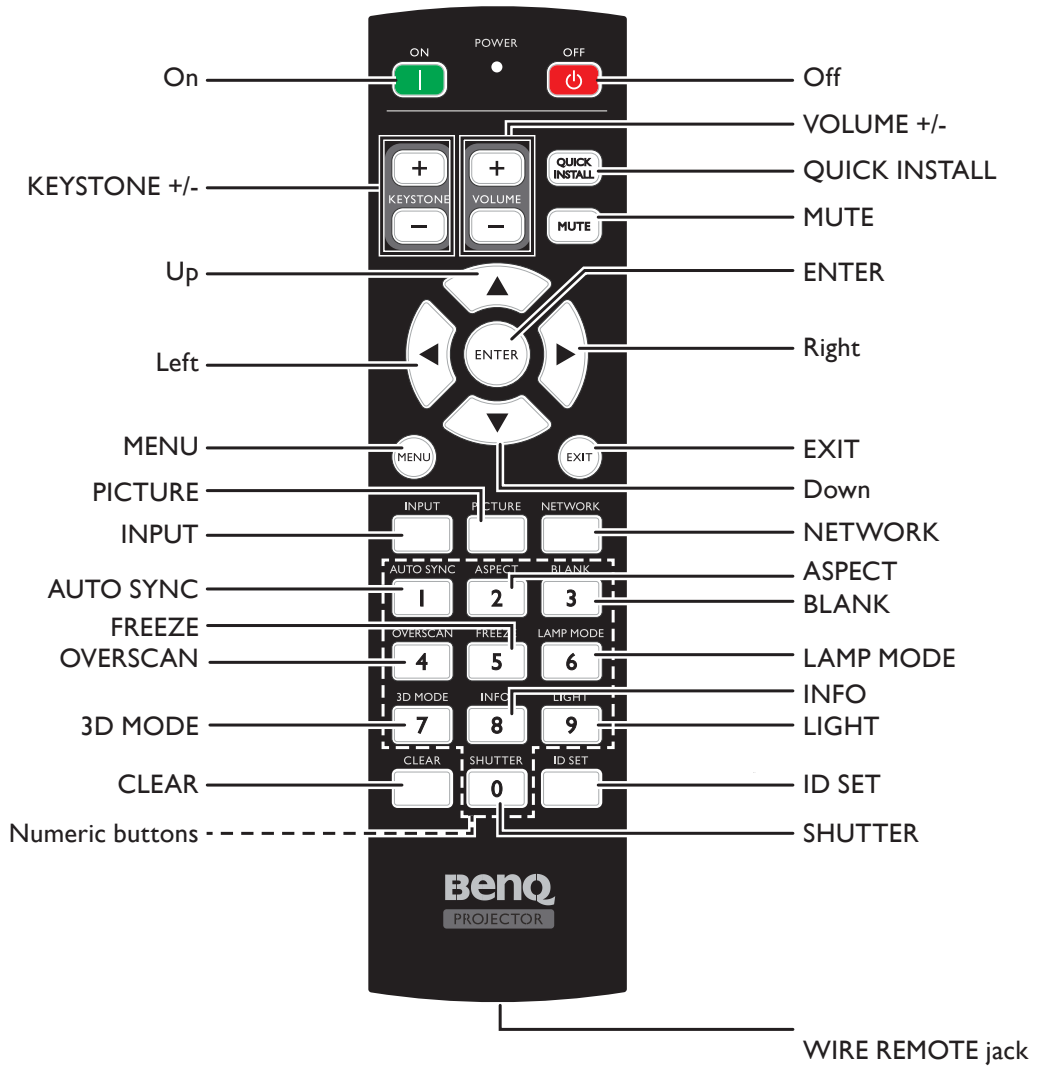

RS232 command

RS232 pin assignment

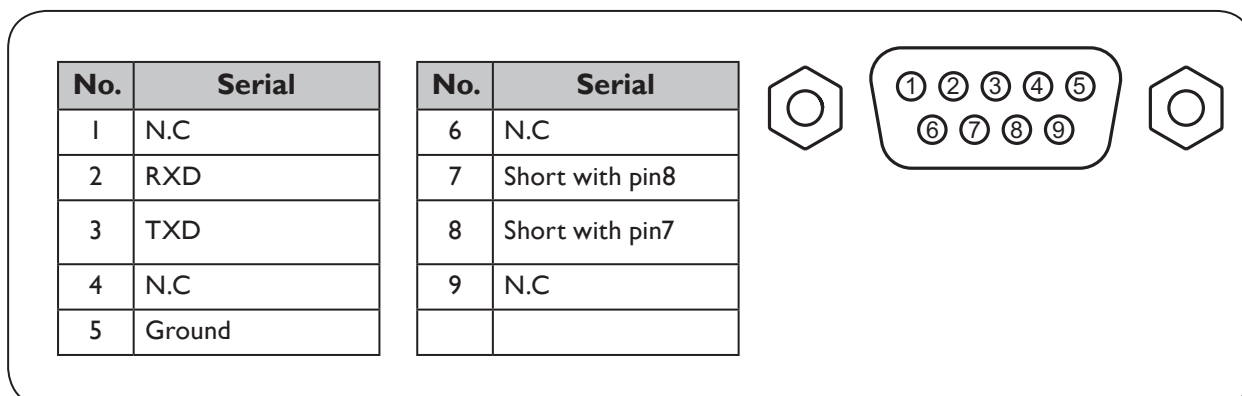

Function	Type	Operation	ASCII
Power	Write	Power On	<CR>*pow=on#<CR>
	Write	Power off	<CR>*pow=off#<CR>
	Read	Power Status	<CR>*pow=?#<CR>
Source Selection	Write	COMPUTER/YPbPr	<CR>*sour=RGB#<CR>
	Write	COMPUTER 2/YPbPr2	<CR>*sour=RGB2#<CR>
	Write	DVI-D	<CR>*sour=dvid#<CR>
	Write	HDMI1	<CR>*sour=hdmi#<CR>
	Write	HDMI 2/MHL2	<CR>*sour=hdmi2#<CR>
	Write	Composite	<CR>*sour=vid#<CR>
	Write	HDbaseT	<CR>*sour=hdbaset#<CR>
	Read	Current source	<CR>*sour=?#<CR>
Audio Control	Write	Mute On	<CR>*mute=on#<CR>
	Write	Mute Off	<CR>*mute=off#<CR>
	Read	Mute Status	<CR>*mute=?#<CR>
	Write	Volume +	<CR>*vol=+#<CR>
	Write	Volume -	<CR>*vol=-#<CR>
	Read	Volume Status	<CR>*vol=?#<CR>
Audio source select	Write	Audio pass Through off	<CR>*audiosour=off#<CR>
	Write	Audio-Computer1	<CR>*audiosour=RGB#<CR>
	Write	Audio-Computer2	<CR>*audiosour=RGB2#<CR>
	Write	Audio-Video	<CR>*audiosour=vid#<CR>
	Write	Audio-Component	<CR>*audiosour=ypbr#<CR>
	Write	Audio-HDMI	<CR>*audiosour=hdmi#<CR>
	Write	Audio-HDMI2	<CR>*audiosour=hdmi2#<CR>
	Read	Audio pass Status	<CR>*audiosour=?#<CR>
Picture Mode	Write	Presentation	<CR>*appmod=preset#<CR>
	Write	sRGB	<CR>*appmod=srgb#<CR>
	Write	Bright	<CR>*appmod=bright#<CR>
	Write	Cinema	<CR>*appmod=cine#<CR>
	Write	DICOM	<CR>*appmod=dicom#<CR>
	Write	User1	<CR>*appmod=user1#<CR>
	Write	3D	<CR>*appmod=threed#<CR>
	Read	Picture Mode	<CR>*appmod=?#<CR>

Function	Type	Operation	ASCII
Picture Setting	Write	Contrast +	<CR>*con=+#<CR>
	Write	Contrast -	<CR>*con=-.#<CR>
	Read	Contrast value	<CR>*con=?#<CR>
	Write	Brightness +	<CR>*bri=+#<CR>
	Write	Brightness -	<CR>*bri=-.#<CR>
	Read	Brightness value	<CR>*bri=?#<CR>
	Write	Color +	<CR>*color=+#<CR>
	Write	Color -	<CR>*color=-.#<CR>
	Read	Color value	<CR>*color=?#<CR>
	Write	Sharpness +	<CR>*sharp=+#<CR>
	Write	Sharpness -	<CR>*sharp=-.#<CR>
	Read	Sharpness value	<CR>*sharp=?#<CR>
	Write	Color Temperature-Warm	<CR>*ct=warm#<CR>
	Write	Color Temperature-Normal	<CR>*ct=normal#<CR>
	Write	Color Temperature-Cool	<CR>*ct=cool#<CR>
	Read	Color Temperature Status	<CR>*ct=?#<CR>
	Write	Aspect 4:3	<CR>*asp=4:3#<CR>
	Write	Aspect 16:9	<CR>*asp=16:9#<CR>
	Write	Aspect 16:10	<CR>*asp=16:10#<CR>
	Write	Aspect Auto	<CR>*asp=AUTO#<CR>
	Write	Aspect Real	<CR>*asp=REAL#<CR>
	Read	Aspect Status	<CR>*asp=?#<CR>
	Write	Digital Zoom In	<CR>*zoomI#<CR>
	Write	Digital Zoom out	<CR>*zoomO#<CR>
	Write	Auto	<CR>*auto#<CR>
	Write	Brilliant color on	<CR>*BC=on#<CR>
	Write	Brilliant color off	<CR>*BC=off#<CR>
Read	Brilliant color status	<CR>*BC=?#<CR>	
Operation Settings	Write	Projector Position-Front Table	<CR>*pp=FT#<CR>
	Write	Projector Position-Rear Table	<CR>*pp=RE#<CR>
	Write	Projector Position-Rear Ceiling	<CR>*pp=RC#<CR>
	Write	Projector Position-Front Ceiling	<CR>*pp=FC#<CR>
	Write	Quick auto search	<CR>*QAS=on#<CR>
	Write	Quick auto search	<CR>*QAS=off#<CR>
	Read	Quick auto search status	<CR>*QAS=?#<CR>
	Read	Projector Position Status	<CR>*pp=?#<CR>
	Write	Direct Power On-on	<CR>*directpower=on#<CR>
	Write	Direct Power On-off	<CR>*directpower=off#<CR>
	Read	Direct Power On-Status	<CR>*directpower=?#<CR>
	Write	Signal Power On-on	<CR>*autopower=on#<CR>
	Write	Signal Power On-off	<CR>*autopower=off#<CR>
	Read	Signal Power On-Status	<CR>*autopower=?#<CR>
	Write	Standby Settings-Network on	<CR>*standbynet=on#<CR>
	Write	Standby Settings-Network off	<CR>*standbynet=off#<CR>
	Read	Standby Settings-Network Status	<CR>*standbynet=?#<CR>
	Write	Standby Settings-Monitor Out on	<CR>*standbymnt=on#<CR>
	Write	Standby Settings-Monitor Out off	<CR>*standbymnt=off#<CR>
	Read	Standby Settings-Monitor Out Status	<CR>*standbymnt=?#<CR>

Function	Type	Operation	ASCII
Baud Rate	Write	2400	<CR>*baud=2400#<CR>
	Write	4800	<CR>*baud=4800#<CR>
	Write	9600	<CR>*baud=9600#<CR>
	Write	14400	<CR>*baud=14400#<CR>
	Write	19200	<CR>*baud=19200#<CR>
	Write	38400	<CR>*baud=38400#<CR>
	Write	57600	<CR>*baud=57600#<CR>
	Write	115200	<CR>*baud=115200#<CR>
	Read	Current Baud Rate	<CR>*baud=?#<CR>
Lamp Control	Read	Lamp Hour	<CR>*ltim=?#<CR>
	Write	Normal mode	<CR>*lampm=lnor#<CR>
	Write	Eco mode	<CR>*lampm=eco#<CR>
	Write	Dimming mode	<CR>* lampm=dimming#<CR>
	Write	Custom mode	<CR>* lampm=custom#<CR>
	Read	Lamp Mode Status	<CR>*lampm=?#<CR>
Miscellaneous	Read	Model Name	<CR>*modelname=?#<CR>
	Write	Blank On	<CR>*blank=on#<CR>
	Write	Blank Off	<CR>*blank=off#<CR>
	Read	Blank Status	<CR>*blank=?#<CR>
	Write	Freeze On	<CR>*freeze=on#<CR>
	Write	Freeze Off	<CR>*freeze=off#<CR>
	Read	Freeze Status	<CR>*freeze=?#<CR>
	Write	Menu On	<CR>*menu=on#<CR>
	Write	Menu Off	<CR>*menu=off#<CR>
	Write	Up	<CR>*up#<CR>
	Write	Down	<CR>*down#<CR>
	Write	Right	<CR>*right#<CR>
	Write	Left	<CR>*left#<CR>
	Write	Enter	<CR>*enter#<CR>
	Write	3D Sync Off	<CR>*3d=off#<CR>
	Write	3D Auto	<CR>*3d=auto#<CR>
	Write	3D Sync Top Bottom	<CR>*3d=tb#<CR>
	Write	3D Sync Frame Sequential	<CR>*3d=fs#<CR>
	Write	3D Frame packing	<CR>*3d=fp#<CR>
	Write	3D Side by side	<CR>*3d=sbs#<CR>
	Write	3D inverter disable	<CR>*3d=da#<CR>
	Write	3D inverter	<CR>*3d=iv#<CR>
	Read	3D Sync Status	<CR>*3d=?#<CR>
	Write	Remote Receiver-front+rear	<CR>*rr=fr#<CR>
	Write	Remote Receiver-front	<CR>*rr=f#<CR>
	Write	Remote Receiver-rear	<CR>*rr=r#<CR>
	Read	Remote Receiver Status	<CR>*rr=?#<CR>
	Write	AMX Device Discovery-on	<CR>*amxdd=on#<CR>
	Write	AMX Device Discovery-off	<CR>*amxdd=off#<CR>
	Read	AMX Device Discovery Status	<CR>*amxdd=?#<CR>
	Read	Mac Address	<CR>*macaddr=?#<CR>
	Write	High Altitude mode on	<CR>*Highaltitude=on#<CR>
	Write	High Altitude mode off	<CR>*Highaltitude=off#<CR>
	Read	High Altitude mode status	<CR>*Highaltitude=?#<CR>