



W8000

Digital Projector

Home Cinema Series

User Manual

Table of contents

Important safety instructions 3

Projector features 7

Shipping contents 8

Projector exterior view 9

Controls and functions 11

Positioning your projector 16

Choosing a location 16

Installing or removing the optional lens 17

Adjusting projected image position using lens shift 18

Obtaining a preferred projected image size 20

Connection 22

HDMI connection 23

Smart devices connection 24

Component Video connection 26

Video connection 27

PC connection 28

Connecting video source devices 29

Operation 30

Starting up the projector 30

Adjusting the projected image 32

Using the menus 34

Securing the projector 35

Utilizing the password function 35

Switching input signal 38

Picture menu 39

Display menu 45

System Setup : Basic menu 47

System Setup : Advanced menu 48

Information menu 50

Shutting down the projector 51

OSD menu structure 52

Maintenance 55

Care of the projector 55

Lamp information 56

Cleaning the filter 60

Replacing the filter 60

Troubleshooting 63

Specifications 64

Projector specifications 64

Dimensions 65

Timing chart 66

Warranty and Copyright information 72

Important safety instructions

Your projector is designed and tested to meet the latest standards for safety of information technology equipment. However, to ensure safe use of this product, it is important that you follow the instructions mentioned in this manual and marked on the product.

Safety Instructions

1. **Please read this manual before you operate your projector.** Save it for future reference.

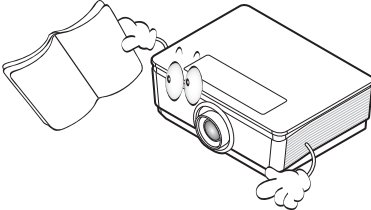

2. **Do not look straight at the projector lens during operation.** The intense light beam may damage your eyes.

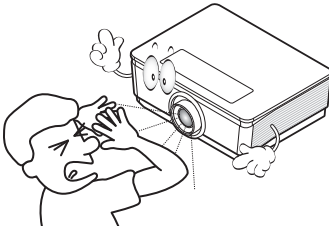

3. **Refer servicing to qualified service personnel.**

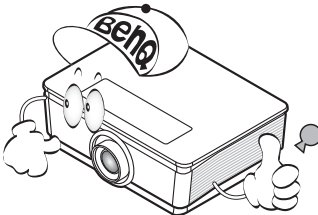

4. **Always open the lens shutter or remove the lens cap when the projector lamp is on.**

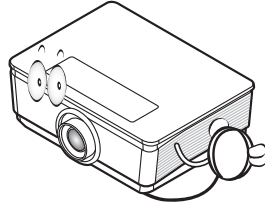

5. In some countries, the line voltage is NOT stable. This projector is designed to operate safely within a mains voltage between 100 to 240 volts AC, but could fail if power cuts or surges of ± 10 volts occur. **In areas where the mains voltage may fluctuate or cut out, it is recommended that you connect your projector through a power stabilizer, surge protector or uninterruptible power supply (UPS).**

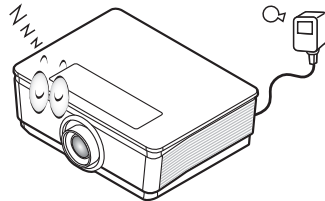

Safety Instructions (Continued)

6. Do not block the projection lens with any objects when the projector is under operation as this could cause the objects to become heated and deformed or even cause a fire. To temporarily turn off the lamp, press **BLANK** on the projector or remote control.

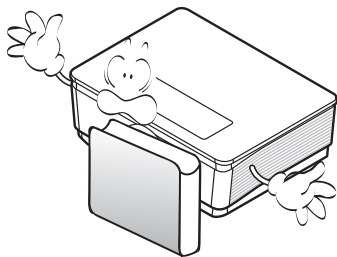

7. The lamp becomes extremely hot during operation. Allow the projector to cool for approximately 45 minutes prior to removing the lamp assembly for replacement.

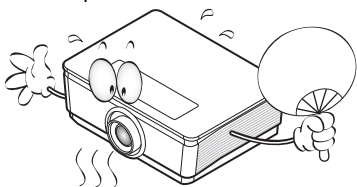

8. Do not operate lamps beyond the rated lamp life. Excessive operation of lamps beyond the rated life could cause them to break on rare occasions.

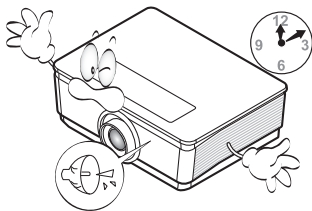

9. Never replace the lamp assembly or any electronic components unless the projector is unplugged.

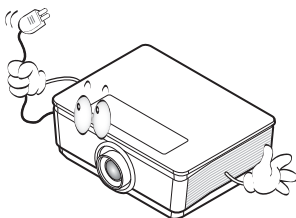

10. Do not place this product on an unstable cart, stand, or table. The product may fall, sustaining serious damage.

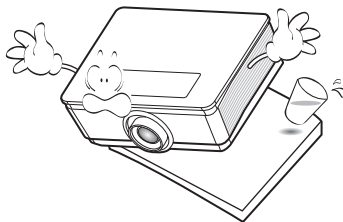

11. Do not attempt to disassemble this projector. There are dangerous high voltages inside which may cause death if you should come into contact with live parts. The only user serviceable part is the lamp which has its own removable cover.

Under no circumstances should you ever undo or remove any other covers. Refer servicing only to suitably qualified professional service personnel.

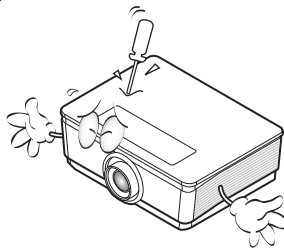

Safety Instructions (Continued)

12. When the projector is under operation, you may sense some heated air and odor from its ventilation grill. It is a normal phenomenon and not a product defect.
13. Do not place this projector in any of the following environments.

- Space that is poorly ventilated or confined. Allow at least 50 cm clearance from walls and free flow of air around the projector.
- Locations where temperatures may become excessively high, such as the inside of a car with all windows rolled up.
- Locations where excessive humidity, dust, or cigarette smoke may contaminate optical components, shortening the projector's life span and darkening the image.

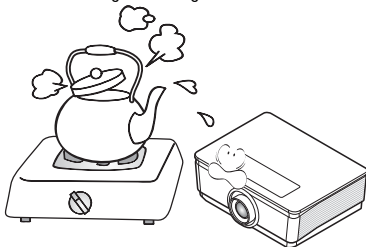

- Locations near fire alarms
- Locations with an ambient temperature above 40°C / 104°F
- Locations where the altitudes are higher than 3000 m (10000 feet).

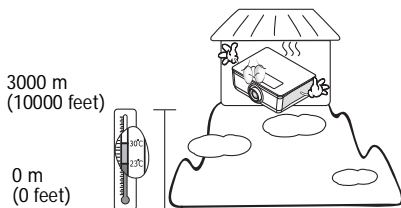

14. Do not block the ventilation holes.
- Do not place this projector on a blanket, bedding or any other soft surface.
 - Do not cover this projector with a cloth or any other item.
 - Do not place inflammables near the projector.



If the ventilation holes are seriously obstructed, overheating inside the projector may result in a fire.

15. Always place the projector on a level, horizontal surface during operation.
- Do not use if tilted at an angle of more than 10 degrees left to right, nor at angle of more than 15 degrees front to back. Using the projector when it is not fully horizontal may cause a malfunction of, or damage to, the lamp.

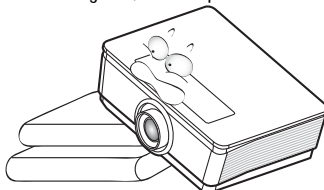

16. Do not stand the projector on end vertically. Doing so may cause the projector to fall over, causing injury or resulting in damage to the projector.

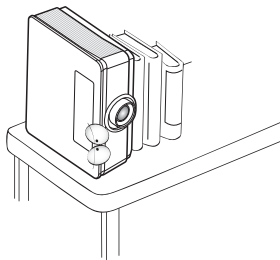

Safety Instructions (Continued)

17. Do not step on the projector or place any objects upon it. Besides probable physical damage to the projector, doing so may result in accidents and possible injury.

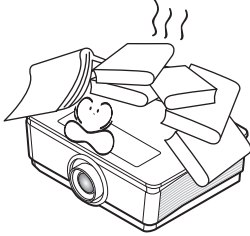

18. Do not place liquids near or on the projector. Liquids spilled into the projector may cause it to fail. If the projector does become wet, disconnect it from the power supply's wall socket and call BenQ to have the projector serviced.

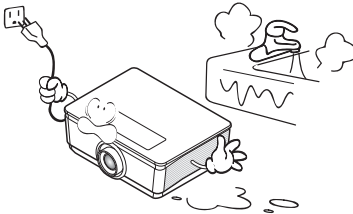

19. This product is capable of displaying inverted images for ceiling mount installation.

! Use only BenQ's Ceiling Mount Kit for mounting the projector and ensure it is securely installed.

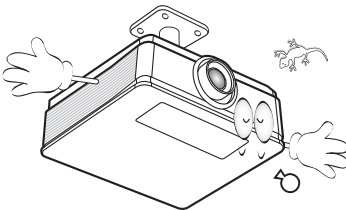

Ceiling mounting the projector

We want you to have a pleasant experience using your BenQ projector, so we need to bring this safety matter to your attention to prevent possible damage to person and property.

If you intend to mount your projector on the ceiling, we strongly recommend that you use a proper fitting BenQ projector ceiling mount kit and that you ensure it is securely and safely installed.

If you use a non-BenQ brand projector ceiling mount kit, there is a safety risk that the projector may fall from the ceiling due to an improper attachment through the use of the wrong gauge or length screws.

You can purchase a BenQ projector ceiling mount kit from the place you purchased your BenQ projector. BenQ recommends that you also purchase a separate Kensington lock compatible security cable and attach it securely to both the Kensington lock slot on the projector and the base of the ceiling mount bracket. This will perform the secondary role of restraining the projector should its attachment to the mounting bracket become loose.



Hg - Lamp contains mercury. Manage in accordance with local disposal laws. See www.lamprecycle.org.

Projector features

- **Full HD compatible**
The projector is compatible with Standard Definition TV (SDTV) 480i, 576i, Enhanced Definition television (EDTV) 480p, 576p and High Definition TV (HDTV) 720p, 1080i/p 60Hz formats, with the 1080p format providing a true 1:1 image reproduction.
- **High picture quality**
The projector provides excellent picture quality due to its high resolution, excellent home theater brightness, high contrast ratio, vivid color and rich gray-scale reproduction.
- **Cinematic color reproduction**
The projector features a precision-tuned RGBRGB color wheel to produce realistic color accuracy depth and range of HDTV standard, ensures that movies are seen with lifelike colors exactly the way the director intended.
- **Rich gray-scale**
When viewed in a darkened environment, the automatic gamma control provides excellent gray-scale display which reveals details in shadows and in night or darkened scenes.
- **Intuitive H/V lens shift**
The intuitive control over lens shift lever provides flexibility in setting-up your projector.
- **Wide variety of inputs and video formats**
The projector supports a wide variety of inputs for connection to your video and PC equipment, including component video, and composite video, as well as dual HDMI, PC, and an output trigger for connection to automated screen and environment lighting systems.
- **ISF certified calibration control**
To reach a higher standard of performance, the projector incorporates ISF NIGHT and ISF DAY mode settings in its OSD menus, which requires professional calibration service from authorized ISF installers.
- **3D function**
To enjoy the 3D movies, videos, and sporting events in a more realistic way by presenting the depth of the images through HDMI.

Shipping contents

Carefully unpack and verify that you have all of the items shown below. If any of these items are missing, please contact your place of purchase.

Standard accessories

 The supplied accessories will be suitable for your region, and may differ from those illustrated.

***The warranty card is only supplied in some specific regions. Please consult your dealer for detailed information.**

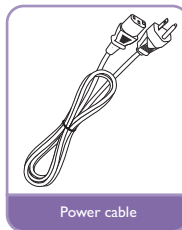
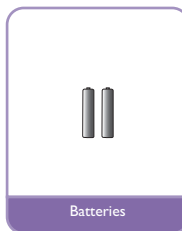
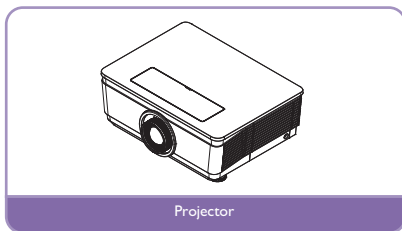

Other accessories

 For below accessories, please consult your dealer for detailed information.

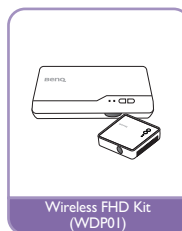
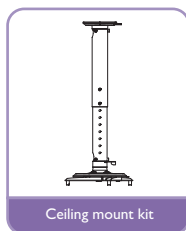

Projector exterior view

Front/upper side

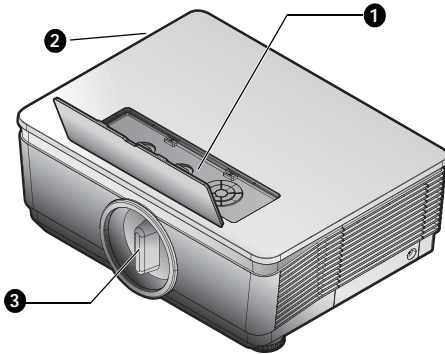

Rear/lower side

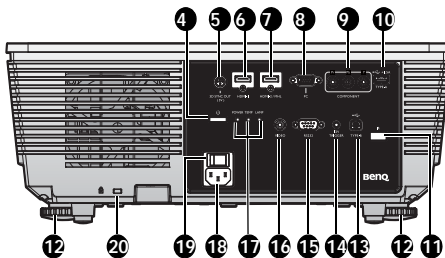

1. External control panel
(See "Projector" on page 11 for details.)
2. Vent (cool air intake)
3. Anti-dust cap
4. Power button
5. 3D SYNC OUT
6. HDMI-1 input jack
7. HDMI 2 / MHL dual mode port
Also can be charging connected MHL compatible smart device as long as the projector is powered on.
8. PC input jack
9. COMPONENT Y/Pb/Pr input
10. USB TYPE-A 1.5A
Used for charging the receiver box of the Wireless FHD Kit (WDP01) (optional accessory)
11. Rear IR remote sensor
12. Front adjuster feet
13. USB TYPE-B port
14. 12 V TRIGGER out jack
Used to trigger external device such as an electric screen or light control, etc. Consult your dealer for how to connect these devices.
15. RS-232 control port
Used to interface with a PC or home theater control/automation system.
16. VIDEO input jack
17. Indicator light (POWER, TEMPerature, LAMP)
18. AC power cord inlet
19. AC Power Switch
20. Kensington anti-theft lock slot

Bottom side

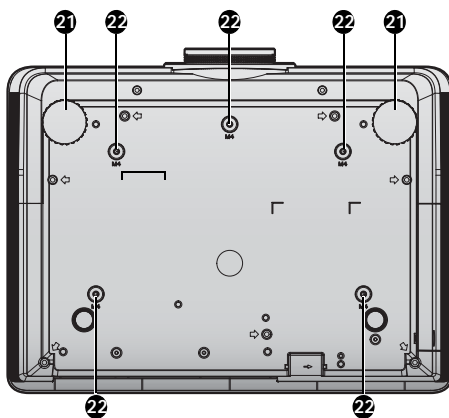

- 21. Front adjuster feet
- 22. Ceiling mount holes

Controls and functions

Projector

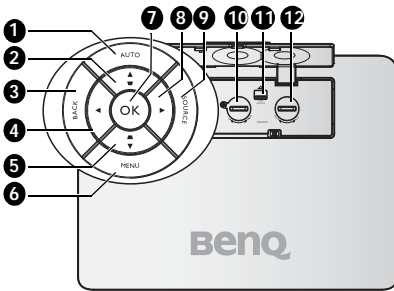

- 1. AUTO**
Automatically determines the best picture timings for the displayed image.
- 2. Keystone/Arrow keys (▲/▲ Up)**
Manually corrects distorted images resulting from an angled projection. See ["Correcting keystone" on page 33](#) for details.
- 3. BACK**
Goes back to previous OSD menu, exits and saves menu settings.
- 4. ◀ Left**
When the On-Screen Display (OSD) menu is activated, the #2, #4, #5, and #8 keys are used as directional arrows to select the desired menu items and to make adjustments. See ["Using the menus" on page 34](#) for details.
- 5. Keystone/Arrow keys (▲/▼ Down)**
Manually corrects distorted images resulting from an angled projection. See ["Correcting keystone" on page 33](#) for details.
- 6. MENU**
Turns on the On-Screen Display (OSD) menu. Goes back to previous OSD menu, exits and saves menu settings. See ["Using the menus" on page 34](#) for details.
- 7. OK**
Selects an available picture setup mode. Confirm the selected On-Screen Display (OSD) menu item. See ["Using the menus" on page 34](#) for details.
- 8. ▶ Right**
When the On-Screen Display (OSD) menu is activated, the #2, #4, #5, and #8 keys are used as directional arrows to select the desired menu items and to make adjustments. See ["Using the menus" on page 34](#) for details.
- 9. SOURCE**
Displays the source selection bar. See ["Switching input signal" on page 38](#) for details.
- 10. LENS SHIFT UP/DOWN**
Rotate to move lens up or down.
- 11. LENS RELEASE button**
Flip to release lens.
- 12. LENS SHIFT RIGHT/LEFT**
Rotate to move lens right or left.

Remote control

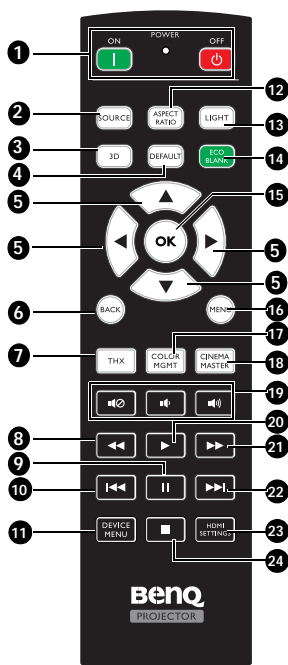

1. **ON / OFF**
Toggles the projector between standby mode and on.
2. **SOURCE**
Displays the source selection bar.
3. **3D**
Launches the 3D menu and toggles the invert function between on and off.
4. **DEFAULT**
Reset the current selected item to default value.
Only available for picture adjustment functions.

5. **Arrow keys (▲ Up, ▼ Down, ◀ Left, ▶ Right)**

When the On-Screen Display (OSD) menu is activated, these keys are used as directional arrows to select the desired menu items and to make adjustments. When the OSD menu is off and you are under the MHL connection mode, these arrows keys are available for controlling your smart device.

6. **BACK**

Goes back to previous OSD menu, exits and saves menu settings.

When the OSD menu is off and you are under the MHL connection mode, use the key to return or exit the OSD menu of your smart device.

7. **PICTURE MODE**

Press to display Picture Mode menu.

8. **◀◀ Backward**

Rewinds during media playback. Only available when controlling your smart device in MHL mode and when projector CEC is on.

9. **|| Pause**

Pause during media playback. Only available when controlling your smart device in MHL mode and when projector CEC is on.

10. **◀◀ Previous**

Goes to the previous file during media playback. Only available when controlling your smart device in MHL mode and when projector CEC is on.

11. **DEVICES MENU**

Press to open connected device OSD when projector CEC is on.

12. **ASPECT RATIO**

Selects the display aspect ratio.

13. LIGHT

The LED backlight lights up and stays on for approximately 30 seconds when pressing any key on the remote control. Pressing any other keys within the 10 second again turns the LED backlight off.

14. ECO BLANK

Used to blank the screen picture.

15. OK

Confirms the selected OSD menu item. When the OSD menu is off and you are under the MHL connection mode, use the key to confirm the selection on the OSD of your smart device.

16. MENU

- Accesses the On-Screen Display (OSD) menu.
- Goes back to previous OSD menu, exits and saves menu settings.

17. COLOR MGMT

Press to display Color Management menu.

18. CINEMAMASTER

Press to display CinemaMaster menu.

19. , , 

This function is available for connected HDMI devices when projector CEC is on.

20.  Play

Play during media playback.

Only available when controlling your smart device in MHL mode and when projector CEC is on.

21.  Fast-forward

Fast-forwards during media playback. Only available when controlling your smart device in MHL mode and when projector CEC is on.

22.  Next

Goes to the next file during media playback.

Only available when controlling your smart device in MHL mode and when projector CEC is on.

23. HDMI SETTINGS

Press to display HDMI Settings menu.

24.  Stop

Stop during media playback.

Only available when controlling your smart device in MHL mode and when projector CEC is on.

Remote control effective range

Infra-Red (IR) remote control sensor is located on the front and the rear of the projector. The remote control must be held at an angle within 30 degrees perpendicular to the projector's IR remote control sensor to function correctly. The distance between the remote control and the sensor should not exceed 8 meters (~ 26 feet).

Make sure that there are no obstacles between the remote control and the IR sensor on the projector that might obstruct the infra-red beam.

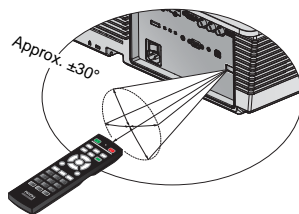
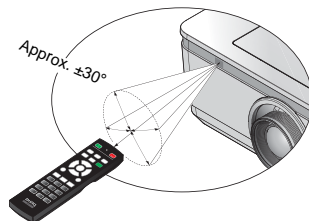

Replacing the remote control battery

1. Remove the battery compartment cover by sliding the cover in the direction of the arrow.

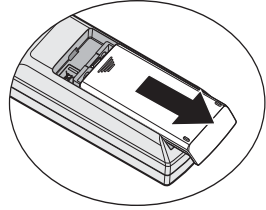

2. Insert the supplied batteries taking note of the polarity (+/-) as shown here.

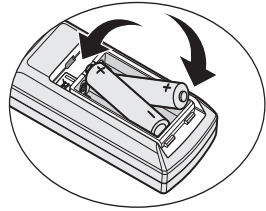

3. Replace the cover.

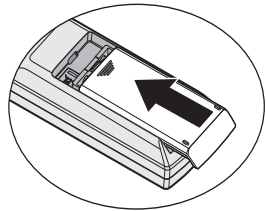

- **Avoid excessive heat and humidity.**
- **There may be battery damage if the battery is incorrectly replaced.**
- **Replace only with the same or equivalent type recommended by the battery manufacturer.**
- **Dispose of the used battery according to the battery manufacturer's instructions.**
- **Never throw a battery into a fire. There may be danger of an explosion.**
- **If the battery is dead or if you will not be using the remote control for a long time, remove the battery to prevent damage to the remote control from possible battery leakage.**

Positioning your projector

Choosing a location

Before choosing an installation location for your projector, take the following factors into consideration:

- Size and position of your screen
- Electrical outlet location
- Location and distance between the projector and the rest of your equipment

You can install your projector in the following ways.

1. Front Table

Select this location with the projector placed near the floor in front of the screen.

This is the most common way to position the projector for quick setup and portability.

Turn on the projector and make the following settings:

MENU > System Setup : Basic > Projector Position > Front

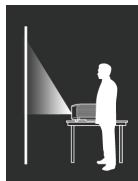

2. Rear Table

Select this location with the projector placed near the floor behind the screen.

Turn on the projector and make the following settings:

MENU > System Setup : Basic > Projector Position > Rear

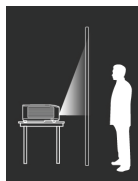

 A special rear projection screen is required.

3. Front Ceiling

Select this location with the projector suspended from the ceiling in front of the screen.

Turn on the projector and make the following settings:

MENU > System Setup : Basic > Projector Position > Front Ceiling

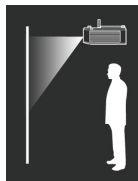

 Purchase the BenQ Projector Ceiling Mount Kit from your dealer to mount your projector on the ceiling.

4. Rear Ceiling

Select this location with the projector suspended from the ceiling behind the screen.

Turn on the projector and make the following settings:

MENU > System Setup : Basic > Projector Position > Rear Ceiling

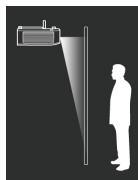

 A special rear projection screen and the BenQ Projector Ceiling Mount Kit are required.

Installing or removing the optional lens



- Do not shake or place excessive pressure on the projector or the lens components as the projector and lens components contain precision parts.
- Before removing or installing the lens, be sure to turn off the projector, wait until the cooling fans stop, and turn off the main power switch.
- Do not touch the lens surface when removing or installing the lens.
- Keep fingerprints, dust or oil off the lens surface. Do not scratch the lens surface.
- Work on a level surface with a soft cloth under it to avoid scratching.
- If you remove and store the lens, attach the lens cap to the projector to keep off dust and dirt.

Removing the existing lens from the projector

1. Flip up the top cover
2. Push the LENSE RELEASE button to the unlock position.
3. Grasp the lens.
4. Rotate the lens counterclockwise. The existing lens will be disengaged.
5. Pull out the existing lens slowly.

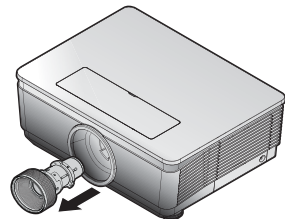
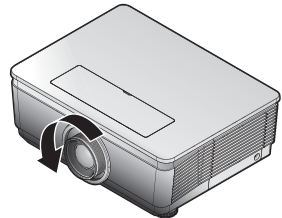
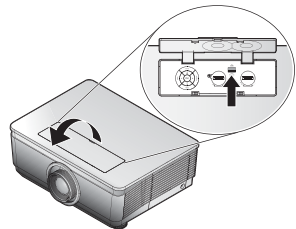

Installing the new lens

Remove both end caps from the lens.

 **Removal of the plastic body cap before inserting a lens for the first time.**

1. Align the flange and correctly position at the 11 o'clock position as shown in the picture.

 **Flange must be positioned at the 11 o'clock position, direction as shown in the picture.**

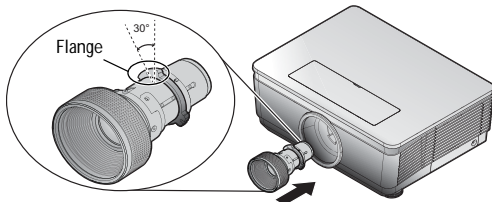

2. Rotate the lens clockwise until you feel it click into place.

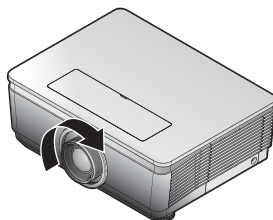

Adjusting projected image position using lens shift

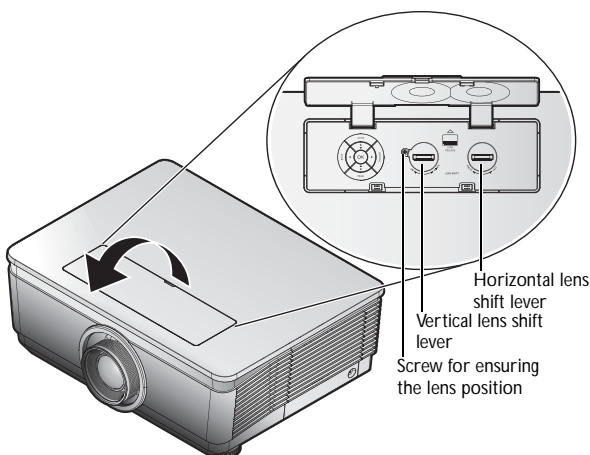

 **Suggest to loosen the screw before lens shift adjustment and tighten up after finished adjustment.**

The Lens Shift function can be used to adjust the position of the projected image either horizontally or vertically within the range detailed below.

Adjusting the vertical image position

The vertical image height can be adjusted between 60% and -20% for 1080P of offset position. Please consult the Lens Shift Range diagram below for further clarification.

Adjusting the horizontal image position

With the lens in the center position the horizontal image position can be adjusted to the left or right by up to a maximum of 5% of the image width. Please consult the Lens Shift Range diagram below for further clarification.

Lens shift range diagram

1080P

Desk-Front Projection

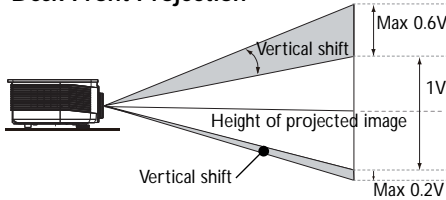

Ceiling Mount-Front Projection

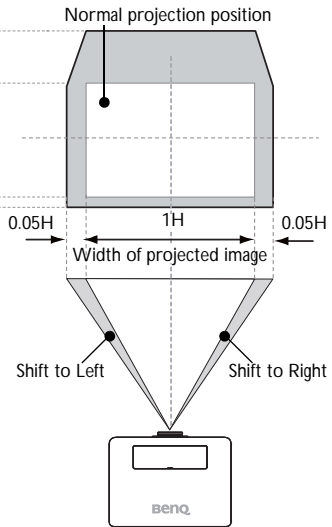
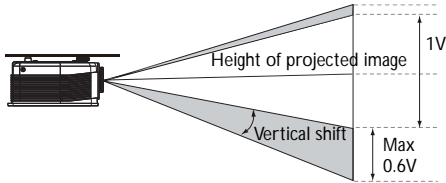

Obtaining a preferred projected image size

The projected image size is determined by the distance from the projector lens to the screen, the zoom setting, and the video format.

Projection dimensions

Refer to "Dimensions" on page 65 for the center of lens dimensions of this projector before calculating the appropriate position.

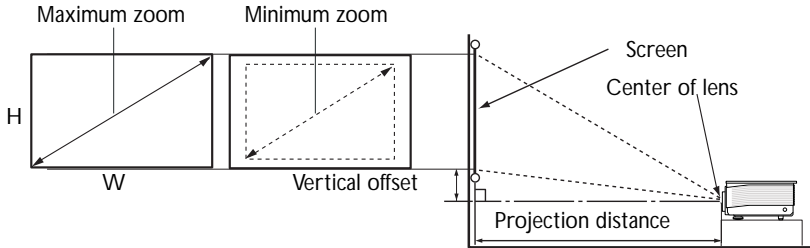

The screen aspect ratio is 16:9 and the projected picture is 16:9.

| Screen Size | | | | | | Wide Zoom | | | | Standard | | | |
|-------------|-------|-------|-------|--------|------|-----------|------|------|------|----------|------|------|------|
| Diagonal | | Width | | Height | | Distance | | | | Distance | | | |
| | | | | | | Wide | | Tele | | Wide | | Tele | |
| Inch | m | Inch | m | Inch | m | Inch | m | Inch | m | Inch | m | Inch | m |
| 80 | 2.03 | 70 | 1.77 | 39 | 1.00 | 77 | 1.95 | 91 | 2.30 | 107 | 2.73 | 135 | 3.42 |
| 100 | 2.54 | 87 | 2.21 | 49 | 1.25 | 96 | 2.44 | 113 | 2.88 | 134 | 3.41 | 168 | 4.27 |
| 120 | 3.05 | 105 | 2.66 | 59 | 1.49 | 115 | 2.92 | 136 | 3.45 | 161 | 4.09 | 202 | 5.13 |
| 150 | 3.81 | 131 | 3.32 | 74 | 1.87 | 144 | 3.65 | 170 | 4.32 | 201 | 5.11 | 252 | 6.41 |
| 200 | 5.08 | 174 | 4.43 | 98 | 2.49 | 192 | 4.87 | 227 | 5.76 | 268 | 6.82 | 336 | 8.55 |
| 300 | 7.62 | 261 | 6.64 | 147 | 3.74 | 288 | 7.31 | 340 | 8.63 | - | - | - | - |
| 400 | 10.16 | 349 | 8.86 | 196 | 4.98 | - | - | - | - | - | - | - | - |
| 500 | 12.70 | 436 | 11.07 | 246 | 6.23 | - | - | - | - | - | - | - | - |

| Screen Size | | | | | | Semi Long | | | | Long Zoom | | | |
|-------------|------|-------|------|--------|------|-----------|------|------|------|-----------|------|------|-------|
| Diagonal | | Width | | Height | | Distance | | | | Distance | | | |
| | | | | | | Wide | | Tele | | Wide | | Tele | |
| Inch | m | Inch | m | Inch | m | Inch | m | Inch | m | Inch | m | Inch | m |
| 80 | 2.03 | 70 | 1.77 | 39 | 1.00 | 135 | 3.42 | 202 | 5.14 | 209 | 5.31 | 349 | 8.86 |
| 100 | 2.54 | 87 | 2.21 | 49 | 1.25 | 168 | 4.27 | 253 | 6.42 | 261 | 6.64 | 436 | 11.07 |
| 120 | 3.05 | 105 | 2.66 | 59 | 1.49 | 202 | 5.13 | 303 | 7.70 | 314 | 7.97 | 523 | 13.28 |
| 150 | 3.81 | 131 | 3.32 | 74 | 1.87 | 252 | 6.41 | 379 | 9.63 | 392 | 9.96 | 654 | 16.60 |

| Screen Size | | | | | | Semi Long | | | | Long Zoom | | | |
|-------------|-------|-------|-------|--------|------|-----------|-------|------|-------|-----------|-------|------|-------|
| Diagonal | | Width | | Height | | Distance | | | | Distance | | | |
| | | | | | | Wide | | Tele | | Wide | | Tele | |
| Inch | m | Inch | m | Inch | m | Inch | m | Inch | m | Inch | m | Inch | m |
| 200 | 5.08 | 174 | 4.43 | 98 | 2.49 | 336 | 8.55 | 506 | 12.84 | 523 | 13.28 | 872 | 22.14 |
| 300 | 7.62 | 261 | 6.64 | 147 | 3.74 | 505 | 12.82 | 758 | 19.26 | 784 | 19.92 | 1307 | 33.21 |
| 400 | 10.16 | 349 | 8.86 | 196 | 4.98 | 673 | 17.09 | 1011 | 25.68 | - | - | - | - |
| 500 | 12.70 | 436 | 11.07 | 246 | 6.23 | - | - | - | - | - | - | - | - |

| Screen Size | | | | | | Wide Fix | |
|-------------|-------|-------|-------|--------|------|----------|------|
| Diagonal | | Width | | Height | | Distance | |
| | | | | | | NA | |
| Inch | m | Inch | m | Inch | m | Inch | m |
| 80 | 2.03 | 70 | 1.77 | 39 | 1.00 | 54 | 1.38 |
| 100 | 2.54 | 87 | 2.21 | 49 | 1.25 | 68 | 1.72 |
| 120 | 3.05 | 105 | 2.66 | 59 | 1.49 | 81 | 2.07 |
| 150 | 3.81 | 131 | 3.32 | 74 | 1.87 | 102 | 2.58 |
| 200 | 5.08 | 174 | 4.43 | 98 | 2.49 | 136 | 3.44 |
| 300 | 7.62 | 261 | 6.64 | 147 | 3.74 | - | - |
| 400 | 10.16 | 349 | 8.86 | 196 | 4.98 | - | - |
| 500 | 12.70 | 436 | 11.07 | 246 | 6.23 | - | - |

☞ There is 5% tolerance among these numbers due to optical component variations. BenQ recommends that if you intend to permanently install the projector, you should physically test the projection size and distance using the actual projector before you permanently install it, so as to make allowance for this projector's optical characteristics. This will help you determine the exact mounting position so that it best suits your installation location.

Connection

When connecting a signal source to the projector, be sure to:

1. Turn all equipment off before making any connections.
2. Use the correct signal cables for each source.
3. Ensure the cables are firmly inserted.

 • In the connections shown below, some cables may not be included with the projector (see "Shipping contents" on page 8). They are commercially available from electronics stores.

- The connection illustrations below are for reference only. The rear connecting jacks available on the projector vary with each projector model.

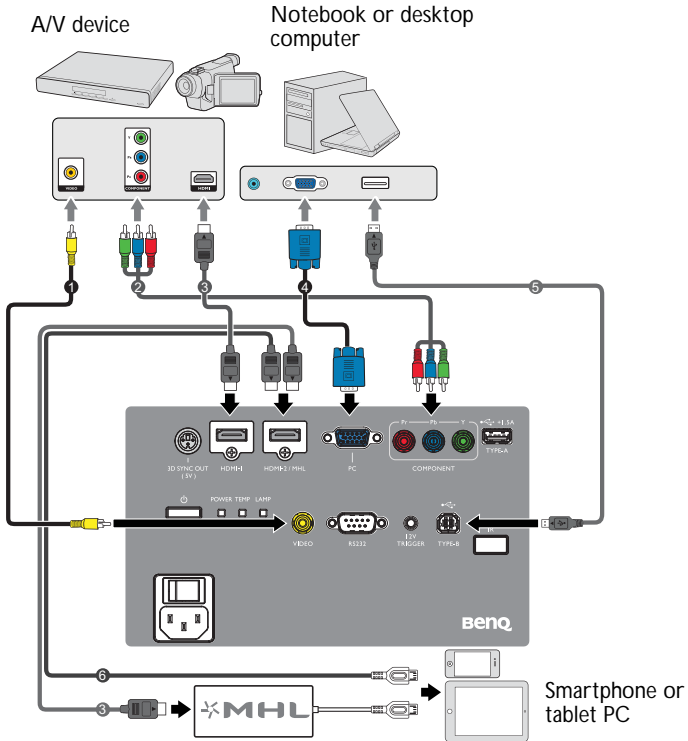

1. Video cable
2. Component Video to Component cable
3. HDMI cable

4. VGA cable
5. USB cable*
6. HDMI-Micro USB cable

*For updating the firmware.

HDMI connection

HDMI (High-Definition Multimedia Interface) supports uncompressed video data transmission between compatible devices like DTV tuners, DVD players, Blu-ray players and displays over a single cable. You should use an HDMI cable when making a connection between the projector and HDMI devices.

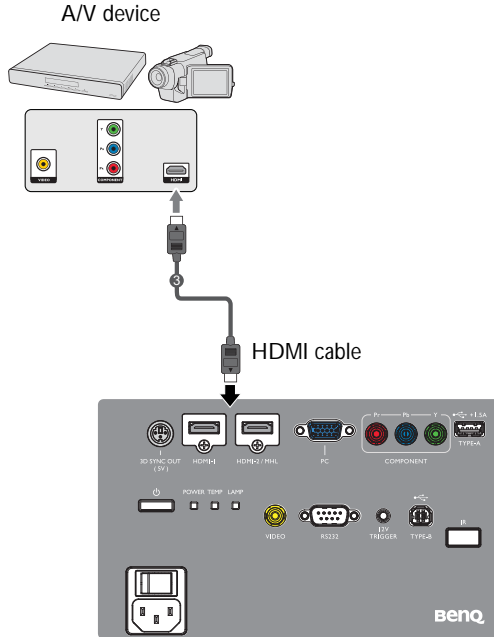

Smart devices connection

The projector can project the content directly from a MHL compatible smart device. Using an HDMI to Micro USB cable or an HDMI to Micro USB adaptor, you can connect your smart devices to the projector and then enjoy your content on the big screen.

 **Some smart devices may not be compatible to the cable that you use. Please consult the manufacturer of your smart device for detailed information.**

Using an HDMI to Micro USB cable

1. Connect one end of the HDMI to Micro USB cable to the HDMI input connector on the projector.
2. Connect the other end of the HDMI to Micro USB cable to the Micro USB output socket on your smart device.
3. Switch to the HDMI/MHL input source. To switch input signal, see "[Switching input signal](#)" on page 38 for details.

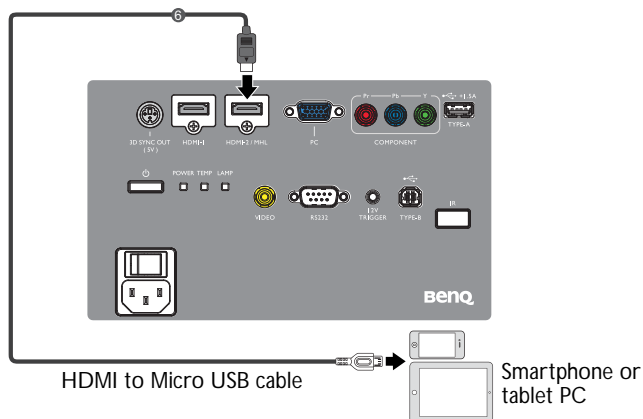

Using an HDMI to Micro USB adaptor and an HDMI cable

1. Connect one end of the HDMI cable to the HDMI input connector on the projector.
2. Connect the other end of the HDMI cable to the HDMI input socket on the adaptor.
3. Connect the other end of the adaptor to the Micro USB output socket on your smart device.
4. Switch to the HDMI/MHL input source. To switch input signal, see "[Switching input signal](#)" on page 38 for details.

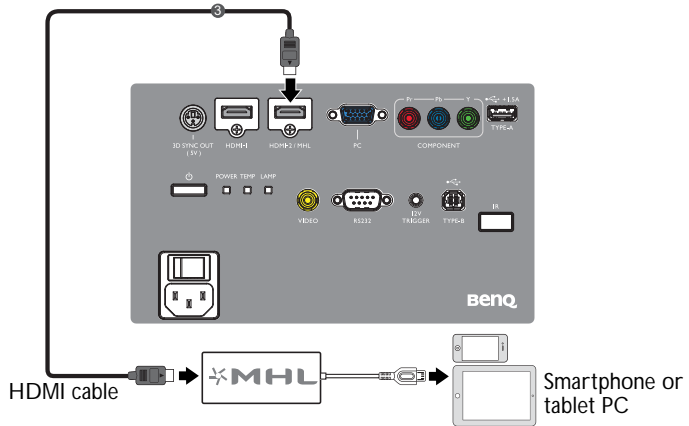

Component Video connection

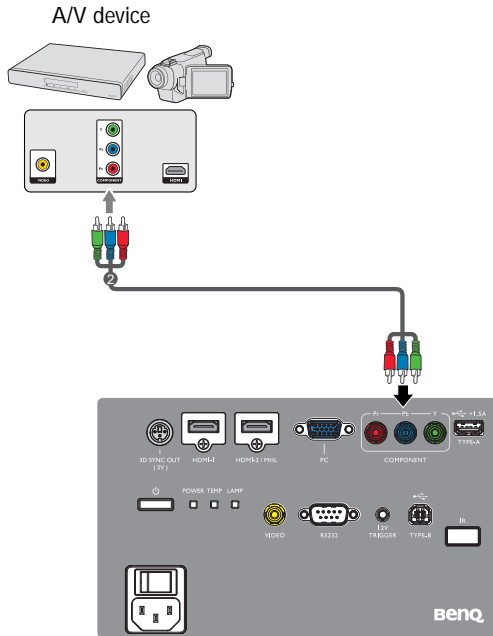

2. Component Video to Component cable

Video connection

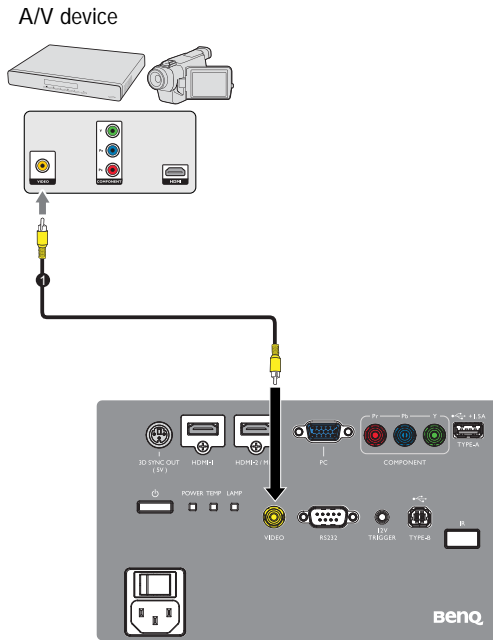

1. Video cable

PC connection

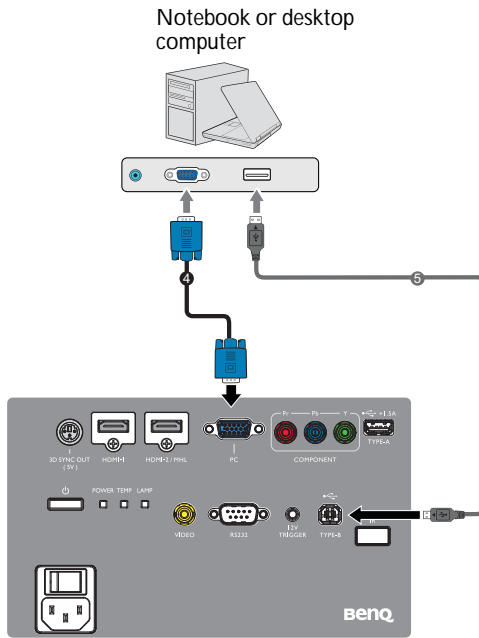



4. VGA cable

5. USB cable

Connecting video source devices

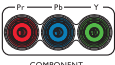
You need only connect the projector to a video source device using just one of the connecting methods, however each provides a different level of video quality. The method you choose will most likely depend upon the availability of matching terminals on both the projector and the video source device as described below:

| Terminal name | Terminal appearance | Reference | Picture quality |
|----------------------|------------------------------------------------------------------------------------------------|--------------------------------------------------------------------------------------------------------------------------------|-----------------|
| HDMI-1 HDMI-2/MHL |  HDMI-1 | <ul style="list-style-type: none">• "HDMI connection" on page 23• "Smart devices connection" on page 24 | Best |
| COMPONENT |  COMPONENT | "Component Video connection" on page 26 | Better |
| VIDEO |  VIDEO | "Video connection" on page 27 | Normal |

 If the selected video image is not displayed after the projector is turned on and the correct video source has been selected, check that the video source device is turned on and operating correctly. Also check that the signal cables have been connected correctly.



Operation

Starting up the projector

1. Plug the power cord into the projector and into a wall socket. Turn on the wall socket switch (where fitted). Check that the **POWER indicator light** on the projector lights orange after power has been applied.

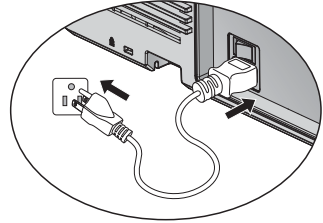



 Please use the original accessories (e.g. power cable) only with the device to avoid possible dangers such as electric shock and fire.



2. Press **POWER** on the projector  or remote control  to start the projector. The **POWER indicator light** flashes green and stays green when the projector is on.

The fans starts operating, and a start-up image display on the screen while it warms up. The projector does not respond to further commands whiles it is warm up. (If necessary) Rotate the focus ring to adjust the image clearness.

 If the projector is still hot from previous activity, it will run the cooling fan for approximately 90 seconds before energizing the lamp.

3. If this is the first time you turn on the projector or after "Reset All Setting", the setup wizard appears to guide you through setting up the projector. If you have already done this, skip this step and move on to step 5.
 - Use the arrow keys (, , , ) on the projector or remote control to move through the menu items.
 - Use OK to confirm the selected menu item.

 The Setup Wizard screenshots below are for reference only and may differ from the actual design.

i. Specify Projector Position.

 For more information about projector position, see "[Choosing a location](#)" on page 16.

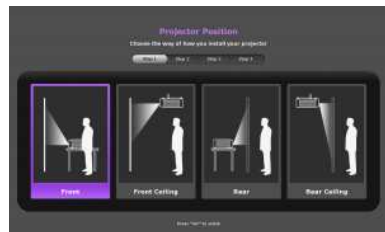

ii. Specify OSD Language.

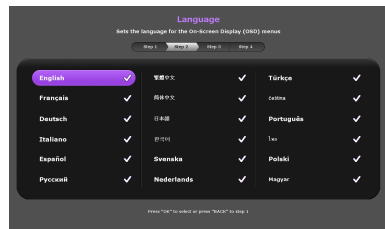

- iii. Specify **Vertical Keystone**.
Press **BACK** for 2 seconds to reset keystone value

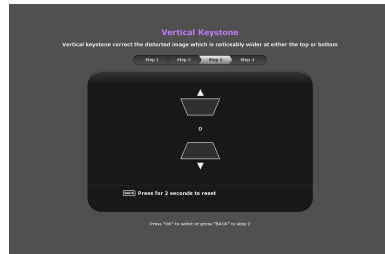

- iv. Specify **Auto Source**.

Now you've completed the initial setup.

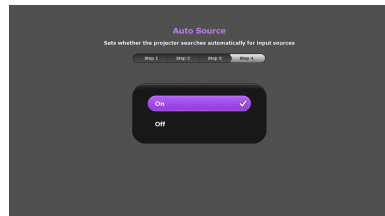

4. If you are prompted for a password, press the arrow keys to enter a six digit password. See "[Utilizing the password function](#)" on page 35 for details.
5. Switch all of the connected equipment on.
6. The projector will start to search for input signals. The current input signal being scanned displays in the upper left corner of the screen. If the projector doesn't detect a valid signal, the message '**No Signal**' will continue displaying until an input signal is found.

You can also press **SOURCE** on the projector or remote control to select your desired input signal. See "[Switching input signal](#)" on page 38 for details.

 If the frequency/resolution of the input signal exceeds the projector's operating range, you will see the message 'Out of Range' displayed on a blank screen. Please change to an input signal which is compatible with the projector's resolution or set the input signal to a lower setting. See "[Timing chart](#)" on page 66 for details.

Adjusting the projected image

Adjusting the projection angle

The projector is equipped with two front adjuster foot. These adjusters change the image height and projection angle. To adjust the projector:

1. Screw the front adjuster foot. Once the image is positioned where you want it.
2. Screw the adjuster foot to fine tune the horizontal angle.

To retract the foot. Screw the adjuster foot in a reverse direction.

If the projector is not placed on a flat surface or the screen and the projector are not perpendicular to each other, the projected image becomes trapezoidal. To correct this situation, see "[Correcting keystone](#)" on page 33 for details.

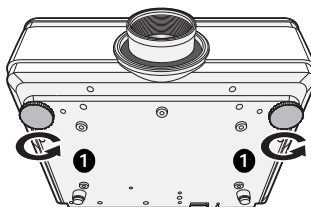

 **Do not look into the lens while the lamp is on. The strong light from the lamp may cause damage to your eyes.**

Auto-adjusting the image

In some cases, you may need to optimize the picture quality. To do this, press **AUTO** on the projector. Within 3 seconds, the built-in Intelligent Auto Adjustment function will re-adjust the values of Frequency and Clock to provide the best picture quality.

The current source information will be displayed in the upper left corner of the screen for 3 seconds.

-  • The screen will be blank while AUTO is functioning.
- This function is only available when PC signal (analog RGB) is selected.

Fine-tuning the image size and clarity

1. Adjust the projected image to the size that you need using the ZOOM ring.

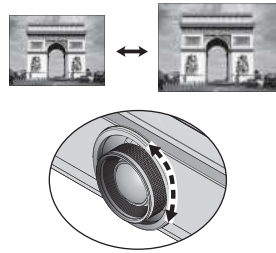

2. Then sharpen the image by rotating the FOCUS ring.

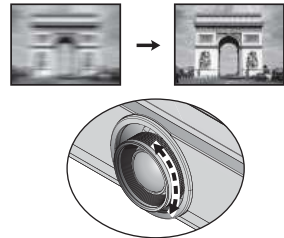

Correcting keystone

Keystoning refers to the situation where the projected image is noticeably wider at either the top or bottom. It occurs when the projector is not perpendicular to the screen.

- Using the projector keypad

Press ▼/▲ on the projector to display the Keystone correction page. Press ▲ to correct keystone at the top of the image. Press ▼ to correct keystone at the bottom of the image.



Using the menus

The OSD menu offers complete menu functions.

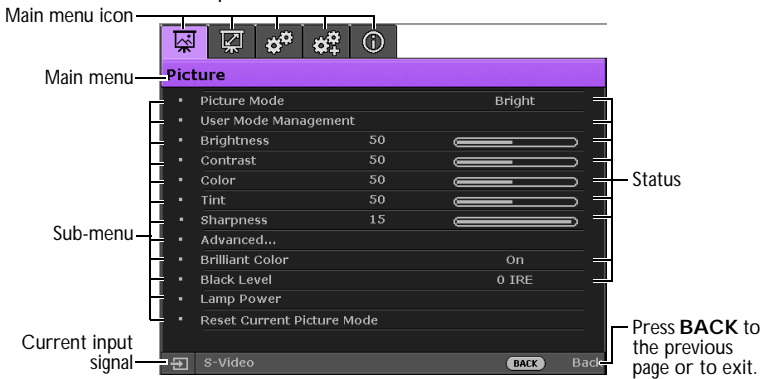

 The OSD menu overview above is for reference only and may differ from the actual design and the projector model you are using.

To access the OSD menu, press **MENU** on the projector or remote control. It is consisted of the following main menus. Check the links after the menu items below to learn more details.

1. **Picture** menu (see "[Picture menu](#)" on page 39)
2. **Display** menu (see "[Display menu](#)" on page 45)
3. **System Setup : Basic** menu (see "[System Setup : Basic menu](#)" on page 47)
4. **System Setup : Advanced** menu (see "[System Setup : Advanced menu](#)" on page 48)
5. **Information** menu (see "[Information menu](#)" on page 50)

Available menu items may vary depending on the connected video sources or specified settings. Menu items that are not available will become grayed out.

- Use the arrow keys (**▲/▼/◀/▶**) on the projector or remote control to move through the menu items.
- Use **OK** to confirm the selected menu item.

Securing the projector

Using a security cable lock

The projector has to be installed in a safe place to prevent theft. Otherwise, purchase a lock, such as a Kensington lock, to secure the projector. You can locate a Kensington lock slot on the left side of the projector. See "[Kensington anti-theft lock slot](#)" on [page 9](#) for details.

A Kensington security cable lock is usually a combination of key(s) and a lock. Refer to the lock's documentation for finding out how to use it.

Utilizing the password function

For security purposes and to help prevent unauthorized use, the projector includes an option for setting up password security. The password can be set through the On-Screen Display (OSD) menu. For details of the OSD menu operation, please refer to "[Using the menus](#)" on [page 34](#).

 You will be inconvenienced if you activate the power-on lock functionality and subsequently forget the password. Print out this manual (if necessary) and write the password you used in this manual, and keep the manual in a safe place for later recall.

Setting a password

 Once a password has been set, the projector cannot be used unless the correct password is entered every time the projector is started.

1. Open the OSD menu and go to the **System Setup: Advanced > Password** menu. Press **OK**. The **Password** page displays.
2. Highlight **Power on Lock** and select **On** by pressing **◀/▶**.
3. As pictured to the right, the four arrow keys (**▲/▼/◀/▶**) respectively represent 4 digits (1, 2, 3, 4). According to the password you desire to set, press the arrow keys to enter six digits for the password.
4. Confirm the new password by re-entering the new password.
Once the password is set, the OSD menu returns to the **Password** page.
5. To activate the **Power on Lock** function, press **▲/▼** to highlight **Power on Lock** and press **◀/▶** to select **On**.

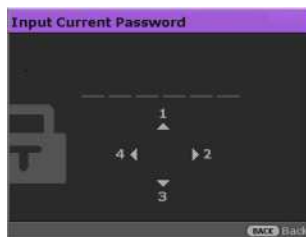

 The digits being input will display as asterisks on-screen. Write your selected password down here in this manual in advance or right after the password is entered so that it is available to you should you ever forget it.

Password: _ _ _ _ _

Keep this manual in a safe place.

6. To leave the OSD menu, press **BACK**.

If you forget the password

If the password function is activated, you will be asked to enter the six-digit password every time you turn on the projector. If you enter the wrong password, the password error message as pictured to the right displays lasting for three seconds, and the message **'INPUT PASSWORD'** follows. You can retry by entering another six-digit password, or if you did not record the password in this manual, and you absolutely do not remember it, you can use the password recall procedure. See ["Entering the password recall procedure" on page 36](#) for details.

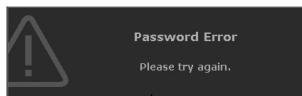

If you enter an incorrect password 5 times in succession, the projector will automatically shut down in a short time.

Entering the password recall procedure

1. Press and hold **AUTO** on the projector for 3 seconds. The projector will display a coded number on the screen.
2. Write down the number and turn off your projector.
3. Seek help from the local BenQ service center to decode the number. You may be required to provide proof of purchase documentation to verify that you are an authorized user of the projector.

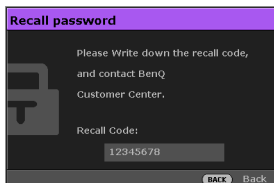

Changing the password

1. Open the OSD menu and go to the **System Setup: Advanced > Password > Change password** menu.
2. Press **OK**. The message '**INPUT CURRENT PASSWORD**' displays.
3. Enter the old password.
 - If the password is correct, another message '**INPUT NEW PASSWORD**' displays.
 - If the password is incorrect, the password error message displays lasting for three seconds, and the message '**INPUT CURRENT PASSWORD**' displays for your retry. You can press **BACK** to cancel the change or try another password.
4. Enter a new password.

 The digits being input will display as asterisks on-screen. Write your selected password down here in this manual in advance or right after the password is entered so that it is available to you should you ever forget it.

Password: _____

Keep this manual in a safe place.

5. Confirm the new password by re-entering the new password.
6. You have successfully assigned a new password to the projector. Remember to enter the new password next time the projector is started.
7. To leave the OSD menu, press **BACK**.

Disabling the password function

To disable password protection, go back to the **System Setup: Advanced > Password > Power on Lock** menu after opening the OSD menu system. Select **Off** by pressing **◀/▶**. The message '**INPUT PASSWORD**' displays. Enter the current password.

- i. If the password is correct, the OSD menu returns to the **Password** page with **Off** show in the row of **Power on Lock**. You will not have to enter the password next time you turn on the projector.
- ii. If the password is incorrect, the password error message displays lasting for three seconds, and the message '**INPUT PASSWORD**' displays for your retry. You can press **BACK** to cancel the change or try another password.

 Though the password function is disabled, you need to keep the old password in hand should you ever need to re-activate the password function by entering the old password.

Switching input signal

The projector can be connected to multiple devices at the same time. However, it can only display one full screen at a time.

If you want the projector to always automatically search for the signals:

- Under the OSD menu, go to the **System Setup : Basic** menu, and enable **Auto Source**. (see "[Auto Source](#)" on page 47)

You can also manually cycle through the available input signals.

1. Press **SOURCE** on the projector or press input source directly from the remote control. A source selection bar displays.
2. Press **▲/▼** until your desired signal is selected and press **OK**.

Once detected, the selected source information will display on the screen for seconds. If there is multiple equipment connected to the projector, repeat steps 1-2 to search for another signal.











-  The brightness level of the projected image will change accordingly when you switch between different input signals. Data (graphic) "PC" presentations using mostly static images are generally brighter than "Video" using mostly moving images (movies).
- The native display resolution of this projector is in a 16:9 aspect ratio. For best display picture results, you should select and use an input signal which outputs at this resolution. Any other resolutions will be scaled by the projector depending upon the 'aspect ratio' setting, which may cause some image distortion or loss of picture clarity. See "[Aspect Ratio](#)" on page 45 for details.



You can also rename the source:

1. Press **MENU** and then press **◀/▶** until the **System Setup: Basic** menu is highlighted.
2. Press **▼** to highlight **Source Rename** and press **OK**. The **Source Rename** page displays.
3. Press **▲/▼/◀/▶** until your desired character is selected and press **OK**.

Picture menu

| Submenu | Functions and Descriptions |
|----------------------|------------------------------------------------------------------------------------------------------------------------------------------------------------------------------------------------------------------------------------------------------------------------------------------------------------------------------------------------------------------------------------------------------------------------------------------------------------------------------------------------------------------------------------------------------------------------------------------------------------------------------------------------------------------------------------------------------------------------------------------------------------------------------------------------------------------------------------------------------------------------------------------------------------------------------------------------------------------------------------------------------------------------------------------------------------------------------------------------------------------------------------------------------------------------------------------------------------------------------------------------------------------------------------------------------------------------------------------------------------------------------------------------------------------------------------------------------------------------------------------------------------------------------------------------------------------------------------------------------------------------------------------------------------------------------------------------------------------------------------------------------------------------------------------------------------------------------------------------------------------------------------------------------|
| Picture Mode | <p>Selects a preset picture mode to suit your operating environment and input signal picture type.</p> <p>The preset picture modes are described as below:</p> <ul style="list-style-type: none"> • Bright: Maximizes the brightness of the projected image. This mode is suitable for environments where extra-high brightness is required, such as using the projector in well lit rooms. • Vivid: With well-saturated color, fine-tuned sharpness and a higher brightness level, Vivid mode is perfect for watching movies in a living room where there is a small amount of ambient light. • THX: Complement the worldwide HDTV standard with accurate color and deepest contrast at lower brightness level, THX mode is suitable for playing movies in a totally dark environment, as if in a commercial cinema. To easily enjoy the cinematic color retrieved from REC. 709 standard, we recommend you shadow all possible lighting items except the projector (e.g. lamps, computer screen, or light coming through curtains) and use a standard format of 1080p image source like a Blu-ray disc to get the best viewing experience under this mode. • Game: Suitable for playing video games in a bright living room. • 3D: It is optimized to bring up 3D effects when watching 3D contents. <p> This mode is only available when 3D function is enabled.</p> <ul style="list-style-type: none"> • User 1/User 2: Recalls the customized settings. Access the Picture OSD menu and see User Mode Management for details. <p> The function is accessible through the remote control.</p> |
| User Mode Management | <p> The functions are only available when Picture Mode is set to User 1 or User 2.</p> <ul style="list-style-type: none"> • Load Settings From Allows you to manually adjust a preset picture mode and make it an available option on the picture mode list. <ol style="list-style-type: none"> 1. Go to the Picture > Picture Mode menu, select User 1 or User 2. 2. Press ▼ to select User Mode Management. 3. On the User Mode Management window, select Load Settings From and press OK. 4. Press ▼ to select a picture mode that is close to your need. 5. When done, press OK and BACK to return to the Picture menu. 6. Press ▼ to select other submenus you want to make changes and use ◀/▶ to adjust the values. The adjustments define the selected user mode. • Rename User Mode Selects to rename the customized picture modes (User 1 or User 2). <ol style="list-style-type: none"> 1. Go to the Picture > Picture Mode menu, select User 1 or User 2. 2. Press ▼ to select User Mode Management. 3. On the User Mode Management window, select Rename User Mode and press OK. 4. On the Rename User Mode window, use ▲/▼/◀/▶ to select desired characters for the selected mode. 5. When done, press OK and BACK to exit. |

| Submenu | Functions and Descriptions |
|------------|-------------------------------------------------------------------------------------------------------------------------------------------------------------------------------------------------------------------------------------------------------------------------------------------------------------------------------------------------------------------------------------------------------------------------------------------------------------------------------------------------------------------------------------------------------------------------------------------------------------------------------|
| Brightness | <p>Adjusts the brightness of the picture. When adjusting this control, the black areas of the picture appear just as black and details in the dark areas are visible.</p> <div style="display: flex; align-items: center;">  <div style="margin-left: 20px;"> <p>The higher the value, the brighter the picture, while the lower the value, the darker the picture.</p> </div> </div> <p> The function is accessible through the remote control.</p> |
| Contrast | <p>Adjusts the degree of difference between dark and light in the picture. After adjusting the Brightness value, adjust Contrast to set the peak white level.</p> <div style="display: flex; align-items: center;">  <div style="margin-left: 20px;"> <p>The higher the value, the greater the contrast.</p> </div> </div> <p> The function is accessible through the remote control.</p> |
| Color | <p>Adjusts the color saturation level -- the amount of each color in a video picture. Lower settings produce less saturated colors; setting to the minimum value makes the image black and white.</p> <p>If the setting is too high, colors on the image will be overpowering, which makes the image unrealistic.</p> |
| Tint | <p>Adjusts the red and green color tones of the picture.</p> <p>The higher the value, the more reddish the picture becomes. The lower the value, the more greenish the picture becomes.</p> |
| Sharpness | <p>Adjusts to make the picture look sharper or softer.</p> <div style="display: flex; align-items: center;">  <div style="margin-left: 20px;"> <p>The higher the value, the sharper the picture becomes. The lower the value, the softer the picture becomes.</p> </div> </div> <p> The function is accessible through the remote control.</p> |

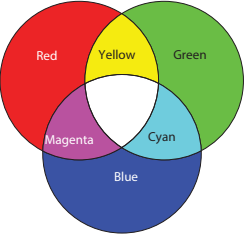

| Submenu | Functions and Descriptions |
|-------------|---------------------------------------------------------------------------------------------------------------------------------------------------------------------------------------------------------------------------------------------------------------------------------------------------------------------------------------------------------------------------------------------------------------------------------------------------------------------------------------------------------------------------------------------------------------------------------------------------------------------------------------------------------------------------------------------------------------------------------------------------------------------------------------------------------------------------------------------------------------------------------------------------------------------------------------------------------------------------------------------------------------------------------------------------------------------------------------------------------------------------------------------------------------------------------------------------------------------------------------------------------------------------------------------------------------------------------------------------------------------------------------------------------------------------------------------------------------------------------------------------------------------------------------------------------------------------------------------------------------------------------------------------------------------------------------------------------------------------------------------------------------------------------------------------------------------------------------------------------------------------------------------------------------------------------------------------------------------------------------------------------------------------------------------------------------------------------------------------------------------------------------------------------------------------------------------------------------------------------------------------------------------------------------------------------------------------------------------------------------------------------------------------------------------------------------------------------------------------------------------------------------------------------------------------------------------------------------------------------------------------------------------------------------------------------------------------------------------------------------------------------------------------------------------------------------------------------------------------------------------|
| Advanced... | <ul style="list-style-type: none"> • Gamma Selection Gamma refers to the relationship between input source and picture brightness. <ul style="list-style-type: none"> • 1.6/1.8/2.0/BenQ: Select these values according to your preference. • 2.1/2.2: Increases the average brightness of the picture. Best for a lit environment, meeting room or family room. • 2.3/2.4: Best for viewing movies in a darkened environment. • 2.5/2.6/2.8: Best for viewing movies which are mostly composed of dark scenes. <div style="text-align: center; margin: 10px 0;"> <div style="display: flex; justify-content: space-between; width: 100%;"> High Brightness Low Brightness </div> <div style="display: flex; justify-content: space-between; width: 100%;"> Low Contrast High Contrast </div>  </div> • Color Temperature Allows you to manually adjust the pre-defined color temperature modes: <ol style="list-style-type: none"> 1. Press OK to display the Color Temperature window. 2. Press ▲/▼ to highlight the item you want to change and adjust the values by pressing ◀/▶. <ul style="list-style-type: none"> • Preset: The options available for color temperature* settings vary according to the connected input signal. <ul style="list-style-type: none"> • Normal: Maintains normal colorings for white. • Cool: Makes images appear bluish white. • Lamp Native: With the lamp's original color temperature and higher brightness. This setting is suitable for environment where high brightness is required, such as projecting pictures in well lit room. • Warm: Makes images appear reddish white. • *About color temperatures: There are many different shades that are considered to be "white" for various purposes. One of the common methods of representing white color is known as the "color temperature". A white color with a low color temperature appears to be reddish white. A white color with a high color temperature appears to have more blue in it. • Red Gain/Green Gain/Blue Gain: Adjusts the contrast levels of Red, Green, and Blue. • Red Offset/Green Offset/Blue Offset: Adjusts the brightness levels of Red, Green, and Blue. 3. When done, press OK and BACK to exit. <p> The function is accessible through the remote control.</p> |





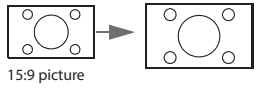
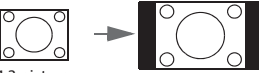
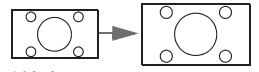
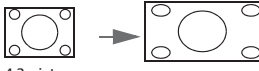

| Submenu | Functions and Descriptions |
|-------------|----------------------------------------------------------------------------------------------------------------------------------------------------------------------------------------------------------------------------------------------------------------------------------------------------------------------------------------------------------------------------------------------------------------------------------------------------------------------------------------------------------------------------------------------------------------------------------------------------------------------------------------------------------------------------------------------------------------------------------------------------------------------------------------------------------------------------------------------------------------------------------------------------------------------------------------------------------------------------------------------------------------------------------------------------------------------------------------------------------------------------------------------------------------------------------------------------------------------------------------------------------------------------------------------------------------------------------------------------------------------------------------------------------------------------------------------------------------------------------------------------------------------------------------------------------------------------------------------------------------------------------------------------------------------------------------------------------------------------------------------------------------------------------------------------------------------------------------------------------------------------------------------------------------------------------------------------------------------------------------------------------------------------------------------------------------------------------------------------------------------------------------------------------------------------------------------------------------------------------------------------------------------------------------------------------------------------------------------------------------------------------------------------------------------------------------------------------------------------------------------------------------------------------------------------------------------------------------------------------------------------------------------------------------------------------------------------------------------------------------------------------------------------------------------------------------------------------------------|
| Advanced... | <ul style="list-style-type: none"> • Color Management <p>In most installation situations, color management will not be necessary, such as in classroom, meeting room, or lounge room situations where lights remain on, or where building external windows allow daylight into the room. Only in permanent installations with controlled lighting levels such as boardrooms, lecture theaters, or home theaters, should color management be considered. Color management provides fine color control adjustment to allow for more accurate color reproduction. Proper color management can only be achieved under controlled and reproducible viewing conditions. You will need to use a colorimeter (color light meter), and provide a set of suitable source images to measure color reproduction. These tools are not provided with the projector, however, your projector supplier should be able to provide you with suitable guidance, or even an experienced professional installer. The Color Management provides six sets (RGBCMY) of colors to be adjusted. When you select each color, you can independently adjust its range and saturation according to your preference.</p> <ol style="list-style-type: none"> 1. Press OK and the Color Management page displays. 2. Highlight Primary color and press ◀/▶ to select a color from among Red, Green, Blue, Cyan, Magenta and Yellow. 3. Press ▼ to highlight Hue and press ◀/▶ to select its range. Increase in the range will include colors consisted of more proportions of its two adjacent colors. Please refer to the illustration to the right for how the colors relate to each other. For example, if you select Red and set its range at 0, only pure red in the projected picture will be selected. Increasing its range will include red close to yellow and red close to magenta. 4. Press ▼ to highlight Saturation and adjust its values to your preference by pressing ◀/▶. Every adjustment made will reflect to the image immediately. For example, if you select Red and set its value at 0, only the saturation of pure red will be affected. 5. Press ▼ to highlight Gain and adjust its values to your preference by pressing ◀/▶. The contrast level of the primary color you select will be affected. Every adjustment made will reflect to the image immediately. 6. Repeat steps 2 to 5 for other color adjustments. 7. Make sure you have made all of the desired adjustments. 8. Press OK and BACK to exit and save the settings.  |

| Submenu | Functions and Descriptions |
|-----------------|---------------------------------------------------------------------------------------------------------------------------------------------------------------------------------------------------------------------------------------------------------------------------------------------------------------------------------------------------------------------------------------------------------------------------------------------------------------------------------------------------------------------------------------------------------------------------------------------------------------------------------------------------------------------------------------------------------------------------------------------------------------------------------------------------------------------------------------------------------------------------------------------------------------------------------------------------------------------------------------------------------------------------------------------------------------------------------------------------------------------------------------------------------------------------------------------------------------------------------------------------------------------------------------------------------------------------------------------------------------------------------------------------------------------------------------------------------------------------------------------------------------------------------------------------------------------------------------------------------------------------------------------------------------------------------------------------------------------------------------------------------------------------------------------------------------------------------------------------------------------------------------------------------------------------------------------------------------------------------------|
| Advanced... | <ul style="list-style-type: none"> • CinemaMaster <ul style="list-style-type: none"> • Color Enhancer: Enhances the color saturation to provide more splendid image quality. The higher the setting, the more vivid the image reveals. The lower the setting, the softer the image reveals. • Flesh Tone: This adjustable item to enable the picture's vividness to be significantly increased. • Pixel Enhancer: Detects the change in color between an object and its background to produce a sharpened image of crisp edges and enhanced surface textures. The higher the setting, the sharper the image reveals. The lower the setting, the tenderer the image reveals. • DCTI: Digital Color Transient Improvement for reduced color smear in the image. • DLTI: Digital Level Transient Improvement for enhanced details in the image. • Motion Enhancer: Estimates the motion changes from frame to frame and inserts and interpolated frame to create smoother, more fluent viewing experience of movies. • Noise Reduction Reduces electrical image noise caused by different media players. The higher the value, the less the noise. • Dynamic Iris To change the black level of the projected image to enhance the effect of contrast ratio. <ul style="list-style-type: none"> 1. This function does not work under 3D mode. 2. Lamp power will not be affected when Dynamic Iris is enabled. 3. When SmartEco mode is selected, Dynamic Iris will be disabled automatically, the item will also be grayed out in OSD. Under this circumstance, a message will pop up. • Film Mode Enhances picture quality when projecting composite image from a filmsourced DVD or Blu-ray Disc. Setting Off disables the function. |
| Brilliant Color | <p>This feature utilizes a new color-processing algorithm and system level enhancements to enable higher brightness while providing truer, more vibrant colors in picture. It enables a greater than 50% brightness increase in mid-tone images, which are common in video and natural scenes, so the projector reproduces images in realistic and true colors. If you prefer images with that quality, select On. If you don't need it, select Off.</p> |
| Black Level | <p>Sets the picture grayscale to 0 IRE or 7.5 IRE. The grayscale video signal is measured in IRE units. In some areas which use NTSC TV standard, the grayscale is measured from 7.5 IRE (black) to 100 IRE (white); however, in other areas where PAL equipment or Japanese NTSC standards are used, the grayscale is measured from 0 IRE (black) to 100 IRE (white). We suggest that you check the input source to see if it is with 0 IRE or 7.5 IRE, then select accordingly.</p> |







| Submenu | Functions and Descriptions |
|----------------------------|--------------------------------------------------------------------------------------------------------------------------------------------------------------------------------------------------------------------------------------------------------------------------------------------------------------------------------------------------------------------------------------------------------------------------------------------------------------------------------------------------------------------------------------------------------------------------------|
| Lamp Power | <p>Selects the projector lamp power from the following modes.</p> <ul style="list-style-type: none"> • Normal: Provides full lamp brightness. • Economic: Reduces system noise and power consumption by 30%. • SmartEco: Reduces system noise and lamp power consumption by up to 70%. <p>If the Economic or SmartEco mode is selected, the light output will be reduced and result in darker projected pictures. See "Setting Lamp Power" on page 56 for details.</p> |
| Reset Current Picture Mode | <p>All of the adjustments you've made for the selected Picture Mode (including preset modes, User 1, and User 2) return to the factory preset values.</p> <ol style="list-style-type: none"> 1. Press OK. The confirmation message displays. 2. Use ◀/▶ to select Reset and press OK. The picture mode returns to the factory preset settings. 3. Repeat steps 1 and 2 if you want to reset other picture modes. |

Display menu

| Submenu | Functions and Descriptions |
|---------------------|----------------------------------------------------------------------------------------------------------------------------------------------------------------------------------------------------------------------------------------------------------------------------------------------------------------------------------------------------------------------------------------------------------------------------------------------------------------------------------------------------------------------------------------------------------------------------------------------------------------------------------------------------------------------------------------------------------------------------------------------------------------------------------------------------------------------------------------------------------------------------------------------------------------------------------------------------------------------------------------------------------------------------------------------------------------------------------------------------------------------------------------------------------------------------------------------------------------------------------------------------------------------------------------------------------------------------------------------------------------------------------------------------------------------------------------------------------------------------------------------------------------------------------------------------------------------------------------------------------------------------------------------------------------------------------------------------------------------------------------------------------------------------------------------------------------------------------------------------------------------------------------------------------------------------------------------------------------------------------------------------------------|
| Aspect Ratio | <p>The native display resolution of this projector is in a 16:9 aspect ratio. However, you may use this function to display projected picture of different aspect ratio.</p> <p> In the following illustrations, the black portions are inactive areas and the white portions are active areas.</p> <ul style="list-style-type: none"> <p>Auto</p>  <p>15:9 picture</p> <p>Scales a picture proportionally to fit the projector's native resolution in its horizontal or vertical width. This makes the most use of the screen and maintains the aspect ratio of a picture.</p> <p>4:3</p>  <p>4:3 picture</p> <p>Scales the picture so that it is displayed in the center of the screen with a 4:3 aspect ratio.</p> <p>16:9</p>  <p>16:9 picture</p> <p>Scales a picture so that it is displayed in the center of the screen with a 16:9 aspect ratio.</p> <p>Wide</p>  <p>4:3 picture</p> <p>Stretches a picture in a horizontal direction to fit the screen width. It does not alter the height of a picture.</p> <p>Anamo. 2.35:1: Vertical stretch image to fit anamorphic lens. Keep the native resolution in its horizontal width and resizes the resolution in its vertical height to 1.321875 times of the original image.</p> <p>Anamo. 16:9: Horizontal squeeze image to fit anamorphic lens. Keep the native resolution in its vertical height and resizes the resolution in its horizontal width to 0.7565 times of the original image.</p> |
| Image Position | <p>Displays the Image Position window. You may use the directional arrow keys on the projector or remote control to adjust the position of the projected picture. The values shown on the lower position of the window change with every key press you made.</p> <p> This function is only available when the PC signal is selected.</p> |
| Overscan Adjustment | <p>Conceals the poor picture quality in the four edges.</p> <p>The greater the value, the more portion of the picture is concealed while the screen remains filled and geometrically accurate. Setting 0 means the picture is 100% displayed.</p> |





| Submenu | Functions and Descriptions |
|--------------------------------|-------------------------------------------------------------------------------------------------------------------------------------------------------------------------------------------------------------------------------------------------------------------------------------------------------------------------------------------------------------------------------------------------------------------------------------------------------------------------------------------------------------------------------------------------------------------------------------------------------------------------------------------------------------------------------------------------------------------------------------------------------------------------------------------------------------------------------------------------------------------------------------------------------------------------------------------------------------------------------------------------------------------------------------------------------------------------------------------------------------------------------------------------------------------------------------------------------------------------------------------------------------------------------------------------------------------------------------------------------------------------------------------------------------------------------------------------------------------------------------------------------------------------------------------------------------------------------------------------------------------------------------------------------------------------------------------------------------------------------------------------------------------------------------------------------------------------------------------------------------------------------------------------------------------------------------------------------------------------------------------------------------------------------------------------------------------------------------------------------------------------------------------------------------------------------------------------------------------------------------------------------------------------------------------------------------------------------------------------------------------------------------------------------------------------------------------------------|
| PC & Component YPbPr Tuning | <ul style="list-style-type: none"> • H. Size Adjusts the horizontal width of the picture.  This function is only available when the PC signal (analog RGB) is selected. • Phase Adjusts the clock phase to reduce picture distortion.  This function is only available when the PC signal (analog RGB) is selected. • Auto (Only for RGBHD PC Timing) Adjusts the phase, and frequency automatically.  This function is only available when the PC signal is selected. |
| 3D | <p>This projector supports playing three-dimensional (3D) content transferred through your 3D-compatible video devices and contents, such as PlayStation consoles (with 3D game discs), 3D Blu-ray 3D players (with 3D Blu-ray discs), 3D TV (with 3D channel), and so on. After you have connected the 3D video devices to the projector, wear the BenQ 3D glasses and make sure the power is on to view 3D contents.</p> <p> When watching 3D contents,</p> <ul style="list-style-type: none"> • The image may seem misplaced, however, this is not a product malfunction. • Take appropriate breaks when watching 3D content. • Stop watching 3D content if you feel fatigue or discomfort. • Keep a distance from the screen of about three times the effective height of the screen when watching 3D content. • Children and people with a history of oversensitivity to light, heart problems, or have any other existing medical condition should be refrained from watching 3D content. <p>The following functions help enhance your 3D viewing experience.</p> <ul style="list-style-type: none"> • 3D Sync Mode Select DLP-Link or 3D VESA for DLP-Link or 3D VESA glasses. • 3D Mode The default setting is Auto and the projector automatically chooses an appropriate 3D format when detecting 3D contents. If the projector cannot recognize the 3D format, manually choose a 3D mode according to your preference.  When this function is enabled: <ul style="list-style-type: none"> • The brightness level of the projected image decreases. • The Picture Mode cannot be adjusted. • 3D Depth Adjust Adjusts the depth level of 3D images on the screen to let you perceive more natural and comfortable effect of 3D contents. • 3D Sync Invert When your 3D image is distorted, enable this function to switch between the image for the left eye and the right eye for the more comfortable 3D viewing experience.  The function is accessible through the remote control. |

System Setup : Basic menu

| Submenu | Functions and Descriptions |
|--------------------|-----------------------------------------------------------------------------------------------------------------------------------------------------------------------------------------------------------------------------------------------------------------------------------------------------------------------------------------------------------------------------------------------------------------------------------------------------------------------------------------------------------------------------------------------------------------|
| Language | Sets the language for the On-Screen Display (OSD) menus. |
| Background Color | Sets the background color when there is no signal to the projector. |
| Splash Screen | Allows you to select which logo screen displays during projector start-up. You can choose BenQ logo screen, Blue screen, or Black screen. |
| Projector Position | The projector can be installed on a ceiling or behind a screen, or with one or more mirrors. See " Choosing a location " on page 16 for details. |
| Auto Off | Prevents unnecessary projection when no signal is detected for a long time. See " Setting Auto Power Off " on page 56 for details. |
| Direct Power On | When the function is set to On , the projector will be turned on automatically once the power is fed through the power cable. When the function is set to Off , you'll have to turn on the projector by pressing  on the projector or  on the remote control. |
| Menu Settings | <ul style="list-style-type: none"> • Menu Position Sets the On-Screen Display (OSD) menu position. • Menu Display Time Sets the length of time the OSD will remain active after your last key press. • Reminder Message Sets whether the reminder message is displayed by the projector while the image is hidden. |
| Source Rename | Renames the current input source to your desired name. On the Source Rename window, use  /  /  /  to set the desired characters for the connected source item. When done, press OK to save the changes. |
| Auto Source | Sets whether the projector searches automatically for input sources. Select On to enable the projector to scan for input sources until it acquires a signal. If the function is set to Off , the projector will select the last used input source. |

System Setup : Advanced menu

| Submenu | Functions and Descriptions |
|----------------|-----------------------------------------------------------------------------------------------------------------------------------------------------------------------------------------------------------------------------------------------------------------------------------------------------------------------------------------------------------------------------------------------------------------------------------------------------------------------------------------------------------------------------------------------------------------------------------------------------------------------------------------------------------------------------------------------------------------------------------------------------------------------------------------------------------------------------------------------------------------------------------------------------------------------------------------------------------------------------------------------------------------------------------------------------------------|
| Lamp Settings | <ul style="list-style-type: none"> • Reset Lamp Timer Activates this function only after a new lamp is installed. When you select Reset, a “Reset Successfully” message displays to notify that the lamp time has been reset to “0”. • Lamp Timer The Lamp Timer function displays the portion of time used by each operation mode: Normal, Eco, SmartEco mode, and the Equivalent Lamp Hour meter. |
| HDMI Settings | <ul style="list-style-type: none"> • HDMI Range Selects an input source type for the HDMI signal. You can also manually select the source type. The different source types carry different standards for the brightness level.  HDMI Range is only available when the HDMI signal is selected. • CEC Enables or disables the CEC function. When you connect an HDMI CEC compatible device to your projector with an HDMI cable, turning on the HDMI CEC compatible device automatically turns on the projector, while turning off the projector automatically turns off the HDMI CEC compatible device. • Power On Link When a device is connected to the projector, turning on the device or the projector can also turn on each other. • Power Off Link When a player device is connected to the projector, turning off the projector will also turn off the player device. |
| Baud Rate | Selects a baud rate that is identical with your computer’s so that you can connect the projector using a suitable RS-232 cable and update or download the projector’s firmware. This function is intended for qualified service personnel. |
| Test Pattern | Enables this function to display the grid test pattern, which helps you adjust the image size and focus so as to check if the projected image is free of distortion. |
| Closed Caption | <ul style="list-style-type: none"> • Closed Caption Enable Activates the function by selecting On when the selected input signal carries closed captions*. *About caption An on-screen display of the dialogue, narration, and sound effects of TV programs and videos that are closed captioned (usually marked as “CC” in TV listings). • Caption Version Selects a preferred closed captioning mode. To view captions, select CC1, CC2, CC3, or CC4 (CC1 displays captions in the primary language in your area). |
| Quick Cooling | Selects On to shorten the projector cooling time from a normal 90-second duration to approximately 3 seconds. |



| Submenu | Functions and Descriptions |
|--------------------|---------------------------------------------------------------------------------------------------------------------------------------------------------------------------------------------------------------------------------------------------------------------------------------------------------------------------------------------------------------------------------------------------------------------------------------------------------------------------------------------------------------------------------------------------------------------------------------------------------------------------------------------------------------------------------------------------------------------------------------------------------------------------------------------------------------------------------------------------------------------------------------------------------------------------------------------------------------------------------------------------------------------------------------------------------------------------------------------------------------------------|
| High Altitude Mode | <p>It is a mode for operation in areas like high altitude or high temperature. Activate the function when your environment is between 1500m – 3000m above sea level and ambient temperature is between 0°C–30°C.</p> <p> Do not use the High Altitude Mode if your altitude is between 0 m and 1500 m and temperature is between 0°C and 30°C. The projector will be over cooled, if you turn the mode on under such a condition.</p> <p>Operation under High Altitude Mode may cause a higher decibel operating noise level because of increased fan speed necessary to improve overall system cooling and performance.</p> <p>If you use this projector under other extreme conditions excluding the above, it may display auto shut-down symptoms, which is designed to protect your projector from over-heating. In cases like this, you should switch to High Altitude mode to solve these symptoms. However, this is not to state that this projector can operate under any and all harsh or extreme conditions.</p> |
| Password | <p>For security purposes and to prevent unauthorized use, you may set up password security for the projector. See "Utilizing the password function" on page 35 for details.</p> <ul style="list-style-type: none"> • Change Password You will be asked to enter the current password before changing to a new one. • Power On Lock Limits use of the projector to only those who know the correct password. |
| Key Lock | <p>With the control keys on the projector locked, you can prevent your projector settings from being changed accidentally (by children, for example).</p> <p>When you select On to enable this function, no control keys on the projector will operate, except  POWER.</p> <p>To unlock the keys, press  and hold on the projector for 3 seconds.</p> |
| 12V Trigger | <p>Enable or disable 12V Trigger signal output.</p> |
| LED Indicator | <p>When you select On, all LED indicators on the projector function normally. See "Indicators" on page 62 for more details.</p> <p>When you select Off, the LED indicators are off after you turn on the projector and the splash screen displays. However, if the projector is not working properly, the LED indicators light or flash to remind you that a problem may occur. See also "Indicators" on page 62 for more details.</p> |
| Reset All Settings | <p>Returns all settings to the factory preset values.</p> <p> The following settings will still remain: ISF, Reset Lamp Timer, Power On Lock, High Altitude Mode, Password.</p> |
| ISF | <p>The ISF calibration menu is password protected and only accessible by authorized ISF calibrators. The ISF (Imaging Science Foundation) has developed carefully crafted, industry-recognized standards for optimal video performance and has implemented a training program for technicians and installers to use these standards to obtain optimal picture quality from BenQ video display devices. Accordingly, we recommend that setup and calibration be performed by an ISF certified installation technician.</p> <p> For more information, please go to www.imagingscience.com or contact the place you purchased the projector.</p> |

Information menu

| Submenu | Functions and Descriptions |
|------------------|------------------------------------------------------------------------------|
| Source | Displays the current signal source. |
| Picture Mode | Displays the current picture mode under the Picture menu. |
| Resolution | Displays the native resolution of the input source. |
| Color System | Displays input system format. |
| Lamp Usage Time | Displays the number of hours the lamp has been used. |
| 3D Format | Displays the current 3D mode. Only available when 3D Mode is enabled. |
| Firmware Version | Displays the firmware version of your projector. |

 Some information is given only when certain input sources are in use.

Shutting down the projector

1. To turn the projector off, press  on the remote control to turn projector off directly. Or you can press  **POWER** on the projector and a warning message appears.

Press  **POWER** again.

2. Once the cooling process finishes, the **POWER indicator light** is a steady orange and fans stop.
3. Disconnect the power cord from the wall socket if the projector will not be used in an extended period of time.

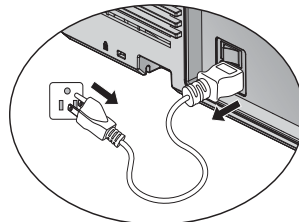

-  • To protect the lamp, the projector will not respond to any commands during the cooling process.
- To shorten the cooling time, you can also activate the Quick Cooling function. See "[Quick Cooling](#)" on page 48 for details.
- If the projector is not properly shut down, to protect the lamp, when you attempt to re-start the projector, the fans will run for a few minutes to cool down. Press **POWER** again to start the projector after the fans stop and the **POWER** indicator light turns orange.
- Lamp life results will vary depending on environmental conditions, and usage.

OSD menu structure

Please note that the on-screen display (OSD) menus vary according to the signal type selected.

| Main menu | Sub-menu | Options | |
|----------------------------|----------------------|---------------------------------------------------------------------------------------------|-------------------------------------------------------------------------------------------------------------------------------------------|
| Picture | Picture Mode | ISF Disabled: Bright/Vivid/THX/Game/User 1/ User 2 | |
| | | ISF Enabled: Bright/Vivid/THX/Game/User 1/ User 2/ISF Night/ISF Day 3D Enabled: 3D | |
| | User Mode Management | Load Settings From | ISF Disabled: Bright/Vivid/THX/Game/User 1/ User 2 ISF Enabled: Bright/Vivid/THX/Game/User 1/ User 2/ISF Night/ ISF Day |
| | | Rename User Mode | |
| | Brightness | | |
| | Contrast | | |
| | Color | | |
| | Tint | | |
| | Sharpness | | |
| | Advanced | Gamma Selection | 1.6/1.8/2.0/2.1/2.2/2.3/2.4/2.5 /2.6/ 2.8/BenQ |
| | | Color Temperature | Preset/Red Gain/Green Gain/Blue Gain/Red Offset/Green Offset/ Blue Offset |
| | | Color Management | Primary Color/Hue/Gain/ Saturation |
| | | Cinema Master | Color Enhancer/Flesh Tone/Pixel Enhancer/DCTI/DLTI/ Motion Enhancer |
| | | Noise Reduction | |
| | | Dynamic Iris | On/Off |
| | | Film Mode | On/Off |
| | | Brilliant Color | On/Off |
| Black Level | | 0 IRE/7.5 IRE | |
| Lamp Power | | Normal/Economic/SmartEco | |
| Reset Current Picture Mode | Reset/Cancel | | |

| Main menu | Sub-menu | Options | | |
|----------------------------|-----------------------------|------------------------------------------------------------------------------------------------------------------------------------------------------------------------------------------------------------------------------------------------------------------------------------------------|----------------------------------------------------------------------------------------------------------------------------|--|
| Display | Aspect Ratio | Auto/4:3/16:9/Wide/ Anamo. 2.35:1/Anamo. 16:9 | | |
| | Image Position | | | |
| | Overscan Adjustment | Video: 0- 3; others: 0-3 | | |
| | PC & Component YPbPr Tuning | H. Size/Phase/Auto | | |
| | 3D | 3D Sync Mode | DLP-Link/3D VESA | |
| | | 3D Mode | Auto (as signal has info frame)/ 3D Off/Frame Sequential/ Frame Packing/Top-Bottom/ Side-by-Side/2D 3D Conversion | |
| | | | 3D Depth Adjust | |
| | | | 3D Sync Invert | |
| | Language | English / Français / Deutsch / Italiano / Español / Русский / 繁體中文 / 简体中文 / 日本語 / 한국어 / Svenska / Nederlands / Türkçe / Čeština / Português / हिन्दी / Polski / Magyar / Hrvatski / Română / Norsk / Dansk / Български / Suomi / Indonesian / Ελληνικά / العربية / हिन्दी | | |
| | Background Color | Black/Blue/Purple | | |
| Splash Screen | BenQ/Black/Blue | | | |
| System Setup: Basic | Projector Position | Front/Front Ceiling/Rear/Rear Ceiling | | |
| | Auto Off | Disable/5 min/10 min/15 min/ 20 min/25 min/30 min | | |
| | Direct Power On | On/Off | | |
| | Menu Settings | Menu Position | Center/Top-Left/Top-Right/ Bottom-Right/Bottom-Left | |
| | | Menu Display Time | Always On/5 sec/10 sec/15 sec/ 20 sec/25 sec/30 sec | |
| | | Reminder Message | On/Off | |
| | Source Rename | | | |
| | Auto Source | On/Off | | |

| Main menu | Sub-menu | Options | |
|-----------------------------------|--------------------|-----------------------------------------------------|------------------------------------------------------------------------------------------|
| System Setup: Advanced | Lamp Settings | Reset Lamp Timer Reset/Cancel | |
| | | Lamp Timer Lamp Usage Time/ Equivalent Lamp Hour | |
| | HDMI Settings | HDMI Range | Auto/Full Range/Limited Range Full Range: 0 ~255 level Limited Range: 16~235 level |
| | | CEC | On/Off |
| | | Power On Link | Off/Bidirectional/ Projector->Device/ Device -> Projector |
| | | Power Off Link | On/Off |
| | | Baud Rate | 9600/19200/38400/57600/115200 |
| | Test Pattern | On/Off | |
| | Closed Caption | Closed Caption Enable | On/Off |
| | | Caption Version | CC1/CC2/CC3/CC4 |
| | Quick Cooling | On/Off | |
| | High Altitude Mode | On/Off | |
| | Password | Change Password | |
| | | Power On Lock | On/Off |
| | Key Lock | On/Off | |
| | 12V Trigger | On/Off | |
| | LED Indicator | On/Off | |
| | Reset All Settings | Reset/Cancel | |
| | ISF | Input password | |
| | Information | Source | |
| | | Picture Mode | |
| | | Resolution | |
| | | Color System | |
| Lamp Usage Time | | | |
| 3D Format | | | |
| Firmware Version | | | |

Maintenance

Care of the projector

Your projector needs little maintenance. The only thing you need to do on a regular basis is to keep the lens clean.

Never remove any parts of the projector except the lamp. Contact your dealer if other parts need replacing.

Cleaning the lens

Clean the lens whenever you notice dirt or dust on the surface.

Before cleaning any part of the projector, turn it off using the proper shutdown procedure (see "[Shutting down the projector](#)" on page 51), unplug the power cable, and let it cool down completely.

- Use a canister of compressed air to remove dust.
- If there is dirt or smears, use lens-cleaning paper or moisten a soft cloth with lens cleaner and gently wipe the lens surface.
- Never use any type of abrasive pad, alkaline/acid cleaner, scouring powder, or volatile solvent, such as alcohol, benzene, thinner or insecticide. Using such materials or maintaining prolonged contact with rubber or vinyl materials may result in damage to the projector surface and cabinet material.

 **Never touch the lens with your finger or rub the lens with abrasive materials. Even paper towels can damage the lens coating. Only ever use a proper photographic lens brush, cloth, and cleaning solution. Do not attempt to clean the lens while the projector is switched on or is still hot from previous use.**

Cleaning the projector case

Before you clean the case, turn the projector off using the proper shutdown procedure as described in "[Shutting down the projector](#)" on page 51 and unplug the power cord and let it cool down completely.

- To remove dirt or dust, wipe the case with a soft, lint-free cloth.
- To remove stubborn dirt or stains, moisten a soft cloth with water and a neutral pH detergent. Then wipe the case.

 **Never use wax, alcohol, benzene, thinner or other chemical detergents. These can damage the case.**

Storing the projector

To store the projector for an extended time.

- Make sure the temperature and humidity of the storage area are within the recommended range for the projector. Please refer to "[Specifications](#)" on page 64 or consult your dealer about the range.
- Retract the adjuster feet.
- Remove the battery from the remote control.
- Pack the projector in its original packing or equivalent.

Transporting the projector

It is recommended that you ship the projector with its original packing or equivalent.

Lamp information

Getting to know the lamp hour

When the projector is in operation, the duration (in hours) of lamp usage is automatically calculated by the built-in timer.

To obtain the lamp hour information:

1. Press **MENU** and then use the arrow keys (**▲/▼/◀/▶**) to go to **Information** or **Settings > Information**.
2. The **Equivalent Lamp Hour** information displays.
3. Press **BACK** to exit.

Extending lamp life

The projection lamp is a consumable item. To keep the lamp life as long as possible, you can do the following settings via the **Lamp Power** OSD menu.

Setting Lamp Power

Setting the projector in **Economic** or **SmartEco** mode also extends the lamp life.

| Lamp mode | Description |
|-----------------|----------------------------------------------------------------------------------|
| Normal | 100% lamp brightness |
| Economic | Saves 30% lamp power consumption |
| SmartEco | Saves up to 70% lamp power consumption depending on the content brightness level |

Using **Economic** mode reduces system noise and power consumption by 30%. Using **SmartEco** mode reduces system noise and lamp power consumption by up to 70%. If the **Economic** or **SmartEco** mode is selected, the light output will be reduced and result in darker projected pictures.

1. Go to **Picture > Lamp Power**.
2. Press **OK** to display the **Lamp Power** window
3. Press **◀/▶** to move to your desired mode, and press **OK**.
4. When done, press **BACK** to save your changes and exit.

Setting Auto Power Off

This function allows the projector to turn off automatically if no input source is detected after a set period of time.

1. Go to **System Setup : Basic > Auto Off**.
2. Press **◀/▶** to select a time period. If the preset time lengths are not suitable for your presentation, select **Disable**, and the projector will not automatically shut down in a certain time period.
3. When done, press **BACK** to save your changes and exit.

Timing of replacing the lamp



When the **Lamp indicator** lights up red or a message appears suggesting it is time to replace the lamp, please install a new lamp or consult your dealer. An old lamp may cause a malfunction in the projector and in some instances the lamp may explode.

Go to <http://www.benq.com> for a replacement lamp.

 **The Lamp indicator light and Temperature warning light will light up if the lamp becomes too hot. See "Indicators" on page 62 for details.**

The following lamp warning displays will remind you to change the lamp.

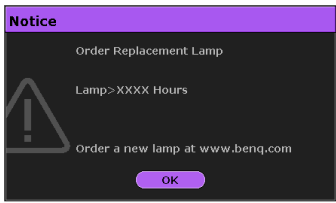
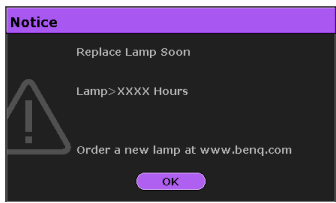
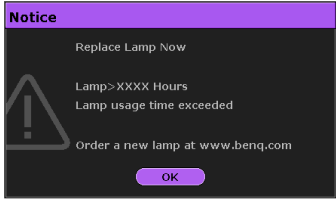
 **The warning messages below are for reference only. Please follow the actual on-screen instructions to prepare and replace the lamp.**

| Status | Message |
|-----------------------------------------------------------------------------------------------------------------------------------------------------------------------------------------------------------------------------------------------------------------------------------------------------------------------------|--------------------------------------------------------------------------------------------------------------------------------------------------------------------------------------------------------------------------------------------------------------------------------------------------------|
| Install a new lamp for optimal performance. If the projector is normally run with Economic selected (See " Getting to know the lamp hour" on page 56), you may continue to operate the projector until the next lamp warning appears. Press OK to dismiss the message. |  <p>Notice</p> <p>Order Replacement Lamp</p> <p>Lamp>XXXX Hours</p> <p>Order a new lamp at www.benq.com</p> <p>OK</p> |
| It is strongly recommended that you replace the lamp at this age. The lamp is a consumable item. The lamp brightness diminishes with use. This is normal lamp behavior. You can replace the lamp whenever you notice that the brightness level has significantly diminished. Press OK to dismiss the message. |  <p>Notice</p> <p>Replace Lamp Soon</p> <p>Lamp>XXXX Hours</p> <p>Order a new lamp at www.benq.com</p> <p>OK</p> |
| |  <p>Notice</p> <p>Replace Lamp Now</p> <p>Lamp>XXXX Hours Lamp usage time exceeded</p> <p>Order a new lamp at www.benq.com</p> <p>OK</p> |
| The lamp MUST be replaced before the projector will operate normally. Press OK to dismiss the message. |  <p>Notice</p> <p>Out of Lamp Usage Time</p> <p>Replace lamp (Refer to user manual) Then reset lamp timer</p> <p>Order a new lamp at www.benq.com</p> <p>OK</p> |

 **"XXXX"** shown in the above messages are numbers that vary depending on different models.

Replacing the lamp



- If lamp replacement is performed while the projector is suspended upside-down from the ceiling, make sure that no one is underneath the lamp socket to avoid any possible injury or damage to the human eyes caused by fractured lamp.
- To reduce the risk of electrical shock, always turn the projector off and disconnect the power cord before changing the lamp.
- To reduce the risk of severe burns, allow the projector to cool for at least 45 minutes before replacing the lamp.
- To reduce the risk of injuries to fingers and damage to internal components, use caution when removing lamp glass that has shattered into sharp pieces.
- To reduce the risk of injuries to fingers and/or compromising image quality by touching the lens, do not touch the empty lamp compartment when the lamp is removed.
- This lamp contains mercury. Consult your local hazardous waste regulations to dispose of this lamp in a proper manner.
- To assure optimal performance from the projector, it is recommended that you purchase a BenQ projector lamp for lamp replacement.
- Ensure good ventilation when handling broken lamps. We recommend that you use respirators, safety glasses, goggles or face shield and wear protective clothing such as gloves.

1. Turn the power off and disconnect the projector from the wall socket. If the lamp is hot, avoid burns by waiting for approximately 45 minutes until the lamp has cooled.
2. Loosen the captive screw from the left side.
3. Remove the lamp compartment cover as shown.

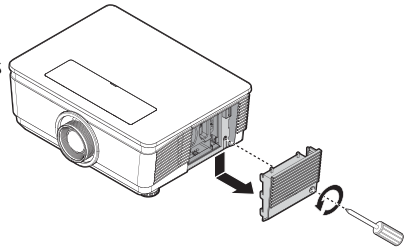

4. Loosen the two captive screws that secure the lamp.



- Do not turn the power on with the lamp cover removed.
- Do not insert your fingers between the lamp and the projector. The sharp edges inside the projector may cause injuries.

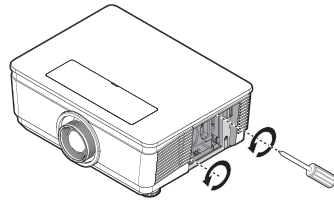

5. Slowly pull the lamp out of the projector.



- Pulling it too quickly may cause the lamp to break and scatter broken glass in the projector.
- Do not place the lamp in locations where water might splash on it, children can reach it, or near flammable materials.
- Do not insert your hands into the projector after the lamp is removed. If you touch the optical components inside, it could cause color unevenness and distortion of the projected images.

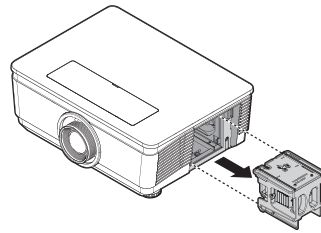

6. Insert the new lamp into the lamp compartment and make sure it fits in the projector.

- Ensure the connectors are aligned.



- If you experience resistance, lift the lamp and start again.

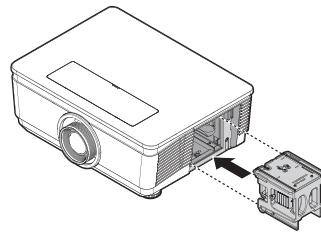

7. Tighten the screws that secure the lamp.



- Loose screw may cause a bad connection, which could result in malfunction.
- Do not over tighten the screw.

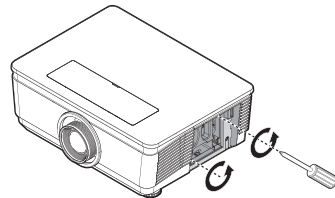

8. Replace the lamp compartment cover on the projector and tighten the captive screw.

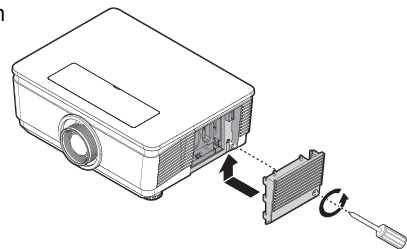

9. Restart the projector.



- Do not turn the power on with the lamp cover removed.

Resetting the lamp timer

10. After the startup logo displays, resetting the lamp timer via the OSD menu.
 - Under the OSD menu, go to **System Setup : Advanced > Reset Lamp Timer**, and select **Reset**.

⚠ **Do not reset if the lamp is not new or replaced as this could cause damage.**

A **"Reset Successfully"** message displays to notify that the lamp time has been reset to **"0"**.

Cleaning the filter

The air filter prevents dust from accumulating on the surface of the optical elements inside the projector. If the filter is dirty or clogged, your projector may overheat or degrading the projected image quality.

1. Turn off the projector, and unplug the AC power cord from the AC outlet.
2. Cleaning the filter with a vacuum cleaner.

⚠ **Recommend avoiding dusty or smoky environments when you operate the projector, it may cause poor image quality. If the filter is heavily clogged and unable to clean, replace a new filter.**

👉 **Using a ladder is recommended to access the filter. Do not remove the projector from the wall mount.**

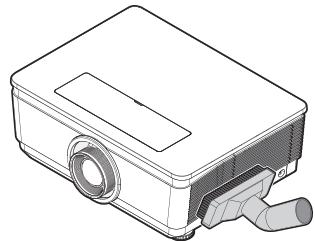

Replacing the filter

1. Turn off the projector, and unplug the AC power cord from the AC outlet. Clean up the dust on the projector and around the air vents. Pull out the filter cover and remove from the projector.

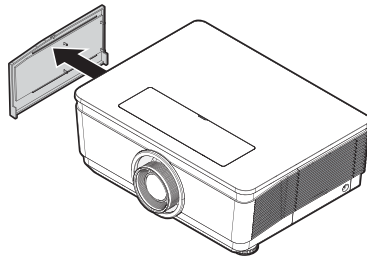

2. Lift the filter from the filter cover.

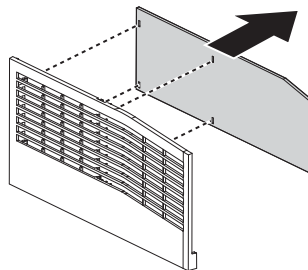

3. Replace a new filter module or replace filter into cover.

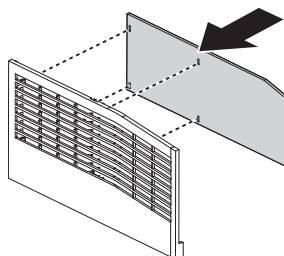

4. Replace the filter cover back to the projector by pushing gently in the direction shown.

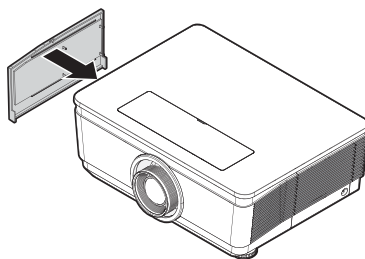

-  Do not wash the filter with the water or other liquid matter.
- When the lamp is replaced, the filter should also be replaced, not cleaned.

Indicators

| Light | | | Status & Description |
|-----------------|----------------|--------------|-------------------------------------------------------------------------------------------------------------------------------------------------------------------------------------|
| Power | Temp | Lamp | |
| Power events | | | |
| Orange | Off | Off | Stand-by mode |
| Green Flashing | Off | Off | Powering up |
| Green | Off | Off | Normal operation |
| Orange Flashing | Off | Off | Projector is cooling. |
| Lamp events | | | |
| Off | Off | Red Flashing | The lamp ignition is not lit up. |
| Off | Off | Red | 1. The projector needs 90 seconds to cool down. Or 2. Please contact your dealer for assistance. |
| Thermal events | | | |
| Red | Red | Off | The fans are not working. The projector has shutdown automatically. If you try to re-start the projector, it will shutdown again. Please contact your dealer for assistance. |
| Red | Red Flashing | Off | |
| Red | Green | Off | |
| Red | Green Flashing | Off | |
| Green | Red | Off | Temperature 1 error (over limited temperature). |
| Green | Red Flashing | Off | Thermal sensor 1 open error. |
| Green | Green | Off | Thermal sensor 1 short error. |
| Green | Green Flashing | Off | Thermal IC #1 I2C connection error. |
| System events | | | |
| Green | Off | Red | The projector has shutdown automatically. If you try to re-start the projector, it will shutdown again. Please contact your dealer for assistance. |
| Red Flashing | Off | Off | |
| Red | Off | Red | |
| Red Flashing | Red Flashing | Red Flashing | Download. |

Troubleshooting

| Problem | Cause | Remedy |
|----------------------------------------|-----------------------------------------------------------------------------------------|----------------------------------------------------------------------------------------------------------------------------------------------------------------------------|
| The projector does not turn on. | There is no power from the power cable. | Plug the power cord into the AC inlet on the projector, and plug the power cord into the power outlet. If the power outlet has a switch, make sure that it is switched on. |
| | Attempting to turn the projector on again during the cooling process. | Wait until the cooling down process has completed. |
| | The lamp cover is not securely attached. | Correctly attach the lamp cover. |
| No picture. | The video source is not turned on or connected correctly. | Turn the video source on and check that the signal cable is connected correctly. |
| | The projector is not correctly connected to the input signal device. | Check the connection. |
| | The input signal has not been correctly selected. | Select the correct input signal with the SOURCE key on the projector or remote control. |
| Image is unstable. | The connection cables are not securely connected to the projector or the signal source. | Correctly connect the cables to the appropriate terminals. |
| Picture is blurred. | The projection lens is not correctly focused. | Adjust the focus of the lens using the focus ring. |
| | The projector and the screen are not aligned properly. | Adjust the projection angle and direction as well as the height of the unit if necessary. |
| | The lens cover is still closed. | Remove the lens cover. |
| Remote control does not work. | The battery is out of power. | Replace the battery with new one. |
| | There is an obstacle between the remote control and the projector. | Remove the obstacle. |
| | You are too far away from the projector. | Stand within 7 meters (23 feet) of the projector. |
| 3D content does not display correctly. | The 3D glasses are out of battery. | Recharge the 3D glasses. |
| | The settings in the 3D menu are not set correctly. | Correctly set the settings in the 3D menu. |
| | Your Blu-ray Disc is not in 3D format. | Use a 3D Blu-ray Disc and try again. |
| | The input source has not been correctly selected. | Select the correct source with the SOURCE key on the projector or remote control. |

Specifications

Projector specifications

 All specifications are subject to change without notice.

Optical

Resolution

1080P

Display system

Single-chip DLP™ system

Lens F/Number

STANDARD LS2SD

F=2.46 to 2.56, f=22.8 to 28.5mm

WIDE FIX LS2ST3

F=2.55, f=11.5mm

WIDE ZOOM LS2ST1

F=2.5 to 3.1, f=28.5 to 42.75mm

SEMI LONG LS2LT1

F=2.05 to 2.27, f=16.64 to 19.5mm

LONG ZOOM1 LS2LT2

F=2.2 to 2.5, f=44.5 to 74.19mm

Lamp

280W lamp

Electrical

Power supply

AC100-240V

50-60 Hz (Automatic)

3.7A

Power consumption

370W (Max); < 0.5W (Standby)

Mechanical

Weight

17.9 lbs (8.1 Kg)

Output terminals

USB

TYPE-A (5V/1.5A)

3D SYNC OUT x 1

Control

USB

Type-B x1

RS-232 serial control

9 pin x 1

IR receiver x 2

12V TRIGGER

12VDC (Max. 0.2 A) x 1

Input terminals

Computer input

RGB input

D-Sub 15-pin (female) x 1

Video signal input

VIDEO

RCA jack x 1

SD/HDTV signal input

Analog - Component RCA jack x 3

Digital - HDMI-1 x 1

HDMI-2/MHL x 1

Environmental Requirements

Operating temperature

0°C–40°C at sea level

Operating relative humidity

10%–90% (without condensation)

Operating altitude

0–1499 m at 0°C–35°C

1500–3000 m at 0°C–30°C (with

High Altitude Mode on)

Dimensions

431.0 mm (W) x 167.0 mm (H) x 320.5 mm (D)

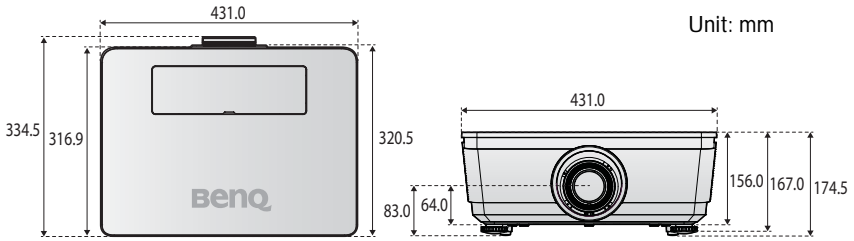

Ceiling Mount Installation

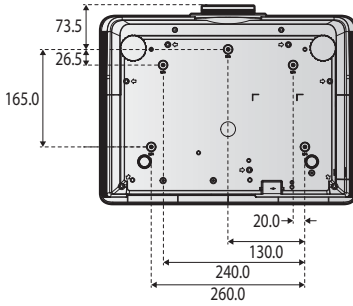

*Ceiling Mount Screws:
M4 (Max. L=12, Min. L=10)

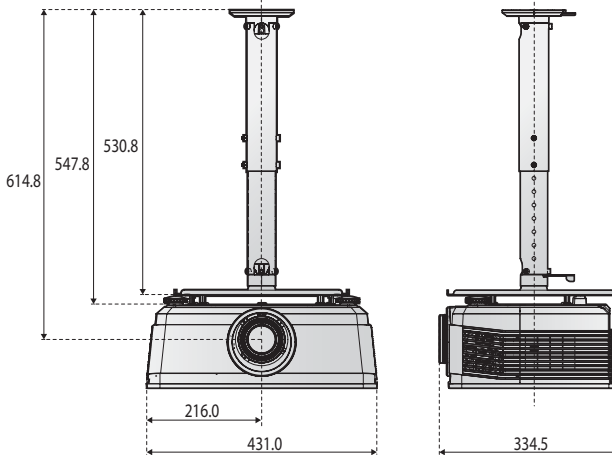

Timing chart

Supported timing for PC input

| Resolution | Mode | Refresh Rate (Hz) | H Frequency (kHz) | Clock (MHz) | 3D Frame Sequential | 3D Top Bottom | 3D side-by-side |
|-------------|-------------------------------|-------------------|-------------------|-------------|---------------------|---------------|-----------------|
| 720 x 400 | 720 x 400_70 | 70.087 | 31.469 | 28.3221 | | | |
| 640 x 480 | VGA_60 | 59.940 | 31.469 | 25.175 | | | |
| | VGA_72 | 72.809 | 37.861 | 31.500 | | | |
| | VGA_75 | 75.000 | 37.500 | 31.500 | | | |
| | VGA_85 | 85.008 | 43.269 | 36.000 | | | |
| 800 x 600 | SVGA_60 | 60.317 | 37.879 | 40.000 | | | |
| | SVGA_72 | 72.188 | 48.077 | 50.000 | | | |
| | SVGA_75 | 75.000 | 46.875 | 49.500 | | | |
| | SVGA_85 | 85.061 | 53.674 | 56.250 | | | |
| | SVGA_120 (Reduce Blanking) | 119.854 | 77.425 | 83.000 | | | |
| 1024 x 768 | XGA_60 | 60.004 | 48.363 | 65.000 | | | |
| | XGA_70 | 70.069 | 56.476 | 75.000 | | | |
| | XGA_75 | 75.029 | 60.023 | 78.750 | | | |
| | XGA_85 | 84.997 | 68.667 | 94.500 | | | |
| | XGA_120 (Reduce Blanking) | 119.989 | 97.551 | 115.500 | | | |
| 1152 x 864 | 1152 x 864_75 | 75.00 | 67.500 | 108.000 | | | |
| 1024 x 576 | BenQ NB Timing | 60.00 | 35.820 | 46.996 | | | |
| 1024 x 600 | BenQ NB Timing | 64.995 | 41.467 | 51.419 | | | |
| 1280 x 720 | 1280 x 720_60 | 60 | 45.000 | 74.250 | | | |
| 1280 x 768 | 1280 x 768_60 | 59.870 | 47.776 | 79.5 | | | |
| 1280 x 800 | WXGA_60 | 59.810 | 49.702 | 83.500 | | | |
| | WXGA_75 | 74.934 | 62.795 | 106.500 | | | |
| | WXGA_85 | 84.880 | 71.554 | 122.500 | | | |
| | WXGA_120 (Reduce Blanking) | 119.909 | 101.563 | 146.25 | | | |
| 1280 x 1024 | SXGA_60 | 60.020 | 63.981 | 108.000 | | | |
| | SXGA_75 | 75.025 | 79.976 | 135.000 | | | |
| | SXGA_85 | 85.024 | 91.146 | 157.500 | | | |

| Resolution | Mode | Refresh Rate (Hz) | H Frequency (kHz) | Clock (MHz) | 3D Frame Sequential | 3D Top Bottom | 3D side-by-side |
|------------------|---------------|-------------------|-------------------|-------------|---------------------|---------------|-----------------|
| 1280 x 960 | 1280 x 960_60 | 60.000 | 60.000 | 108 | | | |
| | 1280 x 960_85 | 85.002 | 85.938 | 148.500 | | | |
| 1360 x 768 | 1360 x 768_60 | 60.015 | 47.712 | 85.500 | | | |
| 1440 x 900 | WXGA+_60 | 59.887 | 55.935 | 106.500 | | | |
| 1400 x 1050 | SXGA+_60 | 59.978 | 65.317 | 121.750 | | | |
| 1600 x 1200 | UXGA | 60.000 | 75.000 | 162.000 | | | |
| 640 x 480 @67Hz | MAC13 | 66.667 | 35.000 | 30.240 | | | |
| 832 x 624 @75Hz | MAC16 | 74.546 | 49.722 | 57.280 | | | |
| 1024 x 768 @75Hz | MAC19 | 74.93 | 60.241 | 80.000 | | | |
| 1152 x 870 @75Hz | MAC21 | 75.06 | 68.68 | 100.00 | | | |

 There 3D timing showing depend the EDID file and VGA display card. It is possible that user cannot choose the above 3D timings on VGA display card.

Support timing for Component - YPbPr input

| Timing | Resolution | Horizontal Frequency (KHz) | Vertical Frequency (Hz) | Dot Clock Frequency (MHz) | 3D Frame Sequential |
|----------|-------------|----------------------------|-------------------------|---------------------------|---------------------|
| 480i | 720 × 480 | 15.73 | 59.94 | 13.5 | ⊙ |
| 480p | 720 × 480 | 31.47 | 59.94 | 27 | ⊙ |
| 576i | 720 × 576 | 15.63 | 50 | 13.5 | |
| 576p | 720 × 576 | 31.25 | 50 | 27 | |
| 720/50p | 1280 × 720 | 37.5 | 50 | 74.25 | |
| 720/60p | 1280 × 720 | 45.00 | 60 | 74.25 | ⊙ |
| 1080/50i | 1920 × 1080 | 28.13 | 50 | 74.25 | |
| 1080/60i | 1920 × 1080 | 33.75 | 60 | 74.25 | |
| 1080/24p | 1920 × 1080 | 27 | 24 | 74.25 | |
| 1080/25p | 1920 × 1080 | 28.13 | 25 | 74.25 | |
| 1080/30p | 1920 × 1080 | 33.75 | 30 | 74.25 | |
| 1080/50p | 1920 × 1080 | 56.25 | 50 | 148.5 | |
| 1080/60p | 1920 × 1080 | 67.5 | 60 | 148.5 | |

Support timing for Video input

| Video mode | Horizontal Frequency (KHz) | Vertical Frequency (Hz) | Sub-carrier Frequency (MHz) | 3D Frame Sequential |
|------------|----------------------------|-------------------------|-----------------------------|---------------------|
| NTSC | 15.73 | 60 | 3.58 | ⊙ |
| PAL | 15.63 | 50 | 4.43 | |
| SECAM | 15.63 | 50 | 4.25 or 4.41 | |
| PAL-M | 15.73 | 60 | 3.58 | |
| PAL-N | 15.63 | 50 | 3.58 | |
| PAL-60 | 15.73 | 60 | 4.43 | |
| NTSC4.43 | 15.73 | 60 | 4.43 | |

Support timing for HDMI (HDCP) input

| Resolution | Mode | Refresh Rate (Hz) | H Frequency (kHz) | Clock (MHz) | 3D Frame Sequential | 3D Top Bottom | 3D side-by-side |
|-------------|----------------------------|-------------------|-------------------|-------------|---------------------|---------------|-----------------|
| 640 x 480 | VGA_60 | 59.940 | 31.469 | 25.175 | | | |
| | VGA_72 | 72.809 | 37.861 | 31.500 | | | |
| | VGA_75 | 75.000 | 37.500 | 31.500 | | | |
| | VGA_85 | 85.008 | 43.269 | 36.000 | | | |
| 720 x 400 | 720 x 400_70 | 70.087 | 31.469 | 28.3221 | | | |
| 800 x 600 | SVGA_60 | 60.317 | 37.879 | 40.000 | | | |
| | SVGA_72 | 72.188 | 48.077 | 50.000 | | | |
| | SVGA_75 | 75.000 | 46.875 | 49.500 | | | |
| | SVGA_85 | 85.061 | 53.674 | 56.250 | | | |
| | SVGA_120 (Reduce Blanking) | 119.854 | 77.425 | 83.000 | | | |
| 1024 x 768 | XGA_60 | 60.004 | 48.363 | 65.000 | | | |
| | XGA_70 | 70.069 | 56.476 | 75.000 | | | |
| | XGA_75 | 75.029 | 60.023 | 78.750 | | | |
| | XGA_85 | 84.997 | 68.667 | 94.500 | | | |
| | XGA_120 (Reduce Blanking) | 119.989 | 97.551 | 115.500 | | | |
| 1152 x 864 | 1152 x 864_75 | 75.00 | 67.500 | 108.000 | | | |
| 1024 x 576 | BenQ Notebook Timing | 60.00 | 35.820 | 46.996 | | | |
| 1024 x 600 | BenQ Notebook Timing | 64.995 | 41.467 | 51.419 | | | |
| 1280 x 720 | 1280 x 720_60 | 60 | 45.000 | 74.250 | | | |
| 1280 x 768 | 1280 x 768_60 | 59.870 | 47.776 | 79.5 | | | |
| 1280 x 800 | WXGA_60 | 59.810 | 49.702 | 83.500 | | | |
| | WXGA_75 | 74.934 | 62.795 | 106.500 | | | |
| | WXGA_85 | 84.880 | 71.554 | 122.500 | | | |
| | WXGA_120 (Reduce Blanking) | 119.909 | 101.563 | 146.25 | | | |
| 1280 x 1024 | SXGA_60 | 60.020 | 63.981 | 108.000 | | | |
| | SXGA_75 | 75.025 | 79.976 | 135.000 | | | |
| | SXGA_85 | 85.024 | 91.146 | 157.500 | | | |
| 1280 x 960 | 1280 x 960_60 | 60.000 | 60.000 | 108 | | | |
| | 1280 x 960_85 | 85.002 | 85.938 | 148.500 | | | |

| Resolution | Mode | Refresh Rate (Hz) | H Frequency (kHz) | Clock (MHz) | 3D Frame Sequential | 3D Top Bottom | 3D side-by-side |
|-------------------|----------------------------------|-------------------|-------------------|-------------|---------------------|---------------|-----------------|
| 1360 x 768 | 1360 x 768_60 | 60.015 | 47.712 | 85.500 | | | |
| 1440 x 900 | WXGA+_60 | 59.887 | 55.935 | 106.500 | | | |
| 1400 x 1050 | SXGA+_60 | 59.978 | 65.317 | 121.750 | | | |
| 1600 x 1200 | UXGA | 60.000 | 75.000 | 162.000 | | | |
| 1680 x 1050 | 1680 x 1050_60 | 59.954 | 65.290 | 146.250 | | | |
| 1920 x 1080 @60Hz | 1920 x 1080_60 (Reduce Blanking) | 60.000 | 67.500 | 148.500 | | | |
| 1920 x 1200 @60Hz | 1920 x 1200_60 (Reduce Blanking) | 59.950 | 74.038 | 154.000 | | | |
| 640 x 480 @67Hz | MAC13 | 66.667 | 35.000 | 30.240 | | | |
| 832 x 624 @75Hz | MAC16 | 74.546 | 49.722 | 57.280 | | | |
| 1024 x 768 @75Hz | MAC19 | 75.020 | 60.241 | 80.000 | | | |
| 1152 x 870 @75Hz | MAC21 | 75.06 | 68.68 | 100.00 | | | |

 There timing showing depend the EDID file and VGA graphic card limitation. It is possible that user cannot choose the above timings on VGA display card.

Supporting timing for HDMI Video input

| Timing | Resolution | Horizontal Frequency (KHz) | Vertical Frequency (Hz) | Dot Clock Frequency (MHz) | 3D Frame Sequential | 3D Frame Packing | 3D Top Bottom | 3D side-by-side |
|----------|------------------|----------------------------|-------------------------|---------------------------|---------------------|------------------|---------------|-----------------|
| 480i | 720 (1440) x 480 | 15.73 | 59.94 | 27 | ⊙ | | | |
| 480p | 720 x 480 | 31.47 | 59.94 | 27 | ⊙ | | | |
| 576i | 720 (1440) x 576 | 15.63 | 50 | 27 | | | | |
| 576p | 720 x 576 | 31.25 | 50 | 27 | | | | |
| 720/50p | 1280 x 720 | 37.5 | 50 | 74.25 | | ⊙ | ⊙ | ⊙ |
| 720/60p | 1280 x 720 | 45.00 | 60 | 74.25 | ⊙ | ⊙ | ⊙ | ⊙ |
| 1080/24p | 1920 x 1080 | 27 | 24 | 74.25 | | ⊙ | ⊙ | ⊙ |
| 1080/25p | 1920 x 1080 | 28.13 | 25 | 74.25 | | | | |
| 1080/30p | 1920 x 1080 | 33.75 | 30 | 74.25 | | | | |
| 1080/50i | 1920 x 1080 | 28.13 | 50 | 74.25 | | | | ⊙ |
| 1080/60i | 1920 x 1080 | 33.75 | 60 | 74.25 | | | | ⊙ |
| 1080/50p | 1920 x 1080 | 56.25 | 50 | 148.5 | | | ⊙ | ⊙ |
| 1080/60p | 1920 x 1080 | 67.5 | 60 | 148.5 | | | ⊙ | ⊙ |

Supporting timing for MHL input

| Timing | Resolution | Horizontal Frequency (KHz) | Vertical Frequency (Hz) | Dot Clock Frequency (MHz) |
|----------|------------------|----------------------------|-------------------------|---------------------------|
| 480i | 720 (1440) x 480 | 15.73 | 59.94 | 27 |
| 480p | 720 x 480 | 31.47 | 59.94 | 27 |
| 576i | 720 (1440) x 576 | 15.63 | 50 | 27 |
| 576p | 720 x 576 | 31.25 | 50 | 27 |
| 720/50p | 1280 x 720 | 37.5 | 50 | 74.25 |
| 720/60p | 1280 x 720 | 45.00 | 60 | 74.25 |
| 1080/24p | 1920 x 1080 | 27 | 24 | 74.25 |
| 1080/25p | 1920 x 1080 | 28.13 | 25 | 74.25 |
| 1080/30p | 1920 x 1080 | 33.75 | 30 | 74.25 |
| 1080/50i | 1920 x 1080 | 28.13 | 50 | 74.25 |
| 1080/60i | 1920 x 1080 | 33.75 | 60 | 74.25 |

Warranty and Copyright information

Limited warranty

BenQ warrants this product against any defects in material and workmanship, under normal usage and storage.

Proof of purchase date will be required with any warranty claim. In the event this product is found to be defective within the warranty period, BenQ's only obligation and your exclusive remedy shall be replacement of any defective parts (labor included). To obtain warranty service, immediately notify the dealer from which you purchased the product of any defects.

Important: The above warranty shall be void if the customer fails to operate the product in accordance with BenQ's written instructions, especially the ambient humidity must be in-between 10% and 85%, temperature in-between 5°C and 28°C, altitude lower than 4920 feet, and avoiding to operate the projector in a dusty environment. This warranty gives you specific legal rights, and you may have other rights which vary from country to country.

For other information, please visit www.BenQ.com.

Copyright

Copyright 2011 by BenQ Corporation. All rights reserved. No part of this publication may be reproduced, transmitted, transcribed, stored in a retrieval system or translated into any language or computer language, in any form or by any means, electronic, mechanical, magnetic, optical, chemical, manual or otherwise, without the prior written permission of BenQ Corporation.

Disclaimer

BenQ Corporation makes no representations or warranties, either expressed or implied, with respect to the contents hereof and specifically disclaims any warranties, merchantability or fitness for any particular purpose. Further, BenQ Corporation reserves the right to revise this publication and to make changes from time to time in the contents hereof without obligation to notify any person of such revision or changes.

*DLP, Digital Micromirror Device and DMD are trademarks of Texas Instruments. Others are copyrights of their respective companies or organizations.

Patents

Please go to <http://patmarking.benq.com/> for the details of the BenQ projector patent