

HITACHI
Inspire the Next

English

Projector
LP-WU9750B
User's Manual

Thank you for purchasing this product. Please read this manual before you operate your projector. Save it for future reference.

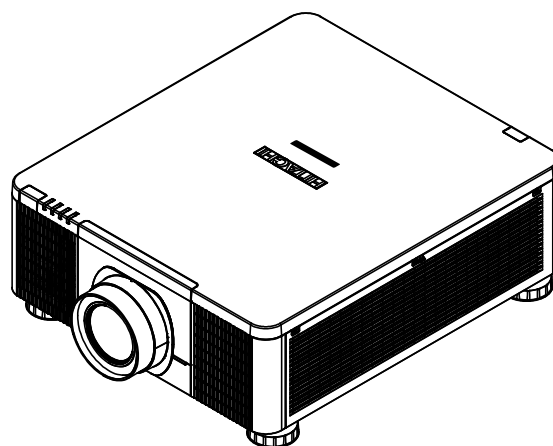

INDEX

Warning, Notices and Safety Instructions	4	Installation the projector.	22
Notice	4	1. Orient the projector towards the screen	22
Do not open	4	2. Remove the lens PU foam on the projector	22
Description pertaining to FCC Rules Part 15	4	3. Depending on your area, to select the correct input voltage.	22
About Waste Electrical and Electronic Equipment	5	4. Connect the power cord to the projector	22
Sun light Warning	5	5. Connect the projector to your PC and flip the switch to “I” to turn on the power.	22
Never look into the projector light source directly	5	6. Starting the projector up.	23
Electric shock	5	7. Adjusting the projector's angle, Lens Shift, Zoom and Focus	23
Do not overload wall outlets/extension cords	6	8. Correcting keystone caused by projection angle	23
Cleaning	6	9. Turning off the projector	24
Dampness, smoke, steam, dust, high temperature and direct exposure to sunlight	6	Throw distance	25
Ventilation	6	Modes of installation	25
Intrusion of foreign objects	6	Front Tabletop	25
Cooling fluid	6	Front Ceiling	26
Carrying the projector	6	Rear Tabletop	26
Please install the projector on an even and stable surface	7	Rear Ceiling	26
Servicing	7	RRear projection - submersive installation	26
Changing parts	7	Horizontal and vertical lens shift	27
Power cord	7	Moving the lens vertically	27
Notices you should read prior to the installation of the projector	8	Moving the lens horizontally	27
Take frequent breaks to let your eyes rest	8	Connecting the projector to other devices	28
Installation environment for the projector	8	HDMI / DVI connection	28
Configurations for projector operation at high altitudes	8	12V Trigger connection	28
Protect the projector with care	8	RGB connection	29
Keep the projector's ventilation inlets and outlets free from obstructions	8	HDBaseT connection	29
Caution for 3D	10	SDI connection	30
LASER WARNING	11	Turning on the projector	30
CLASS 3R LASER PRODUCT	11	Changing OSD language	30
Laser Parameters	11	Adjusting screen orientation	31
Product labels	12	Front Ceiling	31
Location of laser aperture	15	Rear Tabletop	31
Interlock switches	15	Rear ceiling	32
Name and quantity of toxic/hazardous substances/elements contained in the product	16	Adjusting the projector lens	32
Projector parts and functions	17	Remote control	33
Front view	17	OSD Menu Tree	35
Rear view	18		
Bottom view	20		
Range of effective remote control signal reception	21		
Installing batteries in the remote control	21		

OSD Description	38	SERVICE	59
MAIN	38	Model Name	59
Input	38	Serial Number	59
PinP	39	Software Version 1 / 2	59
PinP Selection	39	Active Source	59
PinP Position	39	Signal Format	59
Color Space	40	Laser Hours	60
3D	40	Thermal Status	60
Magnify & Shift	40	Lens Information	60
No Signal	40	Factory Reset	60
PICTURE	41	Cleaning	61
Picture Mode	41	Cleaning the Cabinet	61
Contrast	42	Cleaning the Lens	61
Color	42	Using the Kensington® Lock	62
Tint	42	Simple troubleshooting	63
Sharpness	42	LED STATUS	65
Color Temperature	44	Power LED	65
White Balance	44	Specifications	66
Aspect	45	Supported Signal Input Modes	67
Over Scan	46	SDI formats	68
Position and Phase	46	3D Timing Format	68
Auto Adjust	47	Dimensions	69
LASER	48	Communication settings	70
Power Mode	48	RS-232 Communication	70
Power Level	48	Connection	70
High Altitude	49	1. Protocol	71
ADVANCED	50	2. Command format	71
Installation	50	3. Response code / Error code	72
Lens Control	50	Communication command table	75
Lens Memory	51	Copyright information	88
Lens Centering	51	Copyright	88
Gamma	51	Disclaimer	88
Pattern	51	Trademark	88
Blanking	53	Warranty and after-service	88
Edge blending	53		
Memory	55		
Dynamic Black	55		
SETUP	56		
Network	56		
OSD Setting	57		
Infrared Remote	57		
Remote ID	57		
Start up logo	57		
Trigger	57		
Auto Search	58		
Auto Power Off	58		
Direct Power On	58		
Language	58		
AMX D.D.	58		
Web control/ Crestron Control	58		

Warning, Notices and Safety Instructions

Warning, Notices and Safety Instructions

Notice

This product is intended for the adults who have the ability to operate this machine.

Please write down your projector model number and serial number and keep the information for maintenance purposes in the future. Should the equipment be lost or stolen, the information could also be used for the police report.

Model number:

Serial number:

Please check the accessories that come with the projector with the following list. Should you find any missing accessory, contact your dealer immediately.

- | | | | |
|----------------------------|----------------------|------------------------|---------------------------|
| 1. AC Power Cord US 125V*1 | 4. Remote control *1 | 7. Printed Manual*1 | 10. WEEE Manual *1 |
| 2. AC Power Cord EU*1 | 5. AA battery *2 | 8. EAC Document *1 | 11. RS232 cable(cross) *1 |
| 3. Wire Remote Cable*1 | 6. CD-ROM *1 | 9. EU Recycle Sheet *1 | |

Do not open

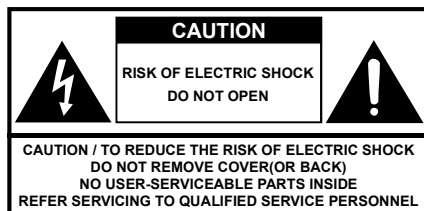

The lightning flash with an arrowhead within a triangle is intended to tell the user that inside this product may cause risk of electrical shock to persons.



The exclamation point within a triangle is intended to tell the user that important operating and/or servicing instructions are included in the technical documentation for this equipment.

This is a Class A product. In a domestic environment this product may cause radio interference in which case the user may be required to take adequate measures.

Description pertaining to FCC Rules Part 15

This device complies with Part 15 of the FCC Rules. Operation is subject to the following two conditions: (1) this device may not cause harmful interference, and (2) this device must accept any interference received, including interference that may cause undesired operation.

This device has been tested and found to comply with the limits for a Class A digital device, pursuant to Part 15 of the FCC Rules. These limits are designed to provide reasonable protection against harmful interference in a residential installation.

This equipment generates, uses and can radiate radio frequency energy. If not installed and used in accordance with the instructions, may cause harmful interference to radio or television reception. However, there is no guarantee that interference will not occur in a particular installation. If this equipment does cause interference to radio or television reception, which can be determined by turning the equipment off and on, the user is encouraged to try to correct the interference by one or the following measures:

- Reorient or relocate the receiving antenna.
- Increase the separation between the equipment and receiver.
- Connect the equipment into an outlet on a circuit different from that to which the receiver is connected.
- Consult the dealer or an experienced radio/TV technician for help.

Warning, Notices and Safety Instructions

CAUTION:

Changes or modifications not expressly approved by the manufacturer void the user's authority to operate the equipment.

This Class A digital apparatus meets all requirements of the Canadian ICES-003 Standards.

Cet appareil numérique de la classe A est conforme à la norme NMB-003 du Canada.

About Waste Electrical and Electronic Equipment



The mark is in compliance with the Waste Electrical and Electronic Equipment Directive 2002/96/EC (WEEE). The mark indicates the requirement NOT to dispose the equipment including any spent or discarded batteries or accumulators as unsorted municipal waste, but use the return and collection systems available. If the batteries or accumulators included with this equipment, display the chemical symbol Hg, Cd, or Pb, then it means that the battery has a heavy metal content of more than 0.0005% Mercury or more than, 0.002% Cadmium, or more than 0.004% Lead.

Sun light Warning

Avoid using this projector in direct sun light.

Sun light on the projector lens can severely damage the Digital Mirror Devices (DMD™).

Never look into the projector light source directly

When turn on the projector, make sure nobody's eye will effects by the projection of light.

Always avoid to let eyes contact to the light.

As with any bright source, do not stare into the direct beam, RG2 IEC 62471-5:2015



Electric shock

To protect your projector, avoid turning on the projector during lightning storms and unplug it from the wall outlet. This will prevent sudden electrical surges caused by the lightning from damaging the projector.

Warning, Notices and Safety Instructions

Do not overload wall outlets/extension cords

Pay attention to the current load of the outlet you are using, be it wall outlet or extension cord outlet to prevent fire or electric shock.

Cleaning

When cleaning the projector, be sure to unplug it from the wall outlet to prevent electric shock.

Do not use liquid or aerosol cleaners. Use a dry/damp cloth with excessive moisture removed for cleaning. Be sure to use cleaning cloth designed to clean monitors for the projector to prevent damages to the projector casing due to abrasion.

Dampness, smoke, steam, dust, high temperature and direct exposure to sunlight

Do not operate the projector in environments where it could be exposed to dampness, smoke, steam, dust, high temperature or direct sunlight. For example: bathroom, kitchen, adjacent to washing machine, damp basement rooms, electric heaters or similar environments. Keeping or operating the projector in the above-mentioned environment could lead to discoloration, mold formation, grease or damages to the projector.

Ventilation

The projector case is designed with slots and openings to remove the heat inside the projector so that it will not overheat and damage the components. Be sure to operate the projector in an environment with ideal ventilation and don't operate it on a sofa, rug or other closed-in environments that could obstruct ventilation.

Intrusion of foreign objects

Be sure to keep all foreign objects away from entering the projector because it could be exposed to hazardous voltages and cause parts to short circuit. This could in turn lead to fire hazard or electric shock. Examples of foreign objects include: cockroach, screws, liquid and so forth.

In addition, never spill liquid into the projector.

Cooling fluid

When the projector is damaged, cooling fluid may come out of internal radiator or the tank. Never touch and drink it. When the fluid is swallowed or contacted with your eyes, Please have doctor's medical examination immediately.

Carrying the projector

The projector net weight is 28kg(not include lens). When moving the projector on a cart, be sure to handle the cart with care as abrupt stops, jolts of excessive force or uneven ground could lead the projector to topple.



Warning, Notices and Safety Instructions

Please install the projector on an even and stable surface

Avoid placing the projector on unstable cart, tripod, table and so forth to prevent the projector from falling, becoming damaged or causing injuries.

Servicing

Should you encounter problem with the projector, please seek assistance from your local dealer or qualified service personnel. Do not attempt to service the projector by yourself so that you would not be exposed to high voltage or other potential hazards.



No service is allowed except by authorized personnel.

Should you encounter any of the following situation, please unplug your projector from the wall outlet and contact a qualified service personnel for assistance:

- Damaged power cord or power plug.
- If a foreign object has fallen into the projector or if you have spilled water or other liquid into the projector.
- If the projector has been dropped accidentally or damaged.
- If you experience noticeably poor performance or malfunctioning with the projector despite having followed instructions for normal operation.

Changing parts

Should any part of the projector be damaged, check with your servicing personnel that only manufacturer certified parts were used for replacement. Used of non-certified parts may result in damages to the projector or hazards such as fire or electric shock. After changing parts, be sure to remind the servicing personnel to perform safety inspections to ensure that the projector operates normally.



No maintenance allowed by end user, Do not open the cabinet.

No user servicable part inside.

Power cord

Don't place the projector where the cord can be walked on. This may result in fraying or damage to the power cord, especially at the plug and the point of connection between the power cord and the projector.

Please use the power cord that comes with the projector or the type of power cord specified for the projector (refer to the descriptions printed on the power cord). If you are not sure of the power available at the region you are in, consult your local power company to prevent damages to the projector due to the use of wrong power cord or potential fire hazards due to current overload.

Depending on the country and region you are in, the voltage and type of socket of the wall outlet may be different from the projector. If you are unable to fit the power plug into the wall outlet, contact your local dealer and do not remove the extra pin on the power plug to forcibly fit it to the socket at the risk of your own safety.

Connect the ground terminal for the AC inlet of this unit to the ground terminal of the building using an appropriate power cord (bundled).

Install the projector where you can access the power outlet easily.

Warning, Notices and Safety Instructions

Notices you should read prior to the installation of the projector

Take frequent breaks to let your eyes rest

Prolonged viewing of the projector screen could strain your eyes. Please be sure to rest your eyes adequately.

Installation environment for the projector

You should avoid installing the projector at place of excessive dampness, dust or smoke. If installation in such environment is unavoidable, be sure to have the interior of the projector

cleaned routinely to prolong the projector's lifecycle. Cleaning of the projector's interior should only be performed by qualified service personnel dispatched by your local dealer and you should not attempt to clean the inside of the projector by yourself.

If other light source is directly projected onto the projector screen, the color of the picture from the projector will appear to be pale and the picture quality will be lower. In addition, your eyes would be more prone to fatigue. Therefore, it is recommended that the projector be installed in places without direct exposure to sunlight or other sources of intense light.

The ideal operating temperature range for the projector is between 0°C ~ 40°C (32°F ~ 104°F)

The ideal storage temperature range for the projector is between -10°C ~ 60°C (14°F ~ 140°F)

Configurations for projector operation at high altitudes

When operating the projector at higher altitudes, be sure to manually set the fan mode to "High" or it could shorten the life of the optical system in the projector. High altitude is defined as places being 1219 meters (4000 feet) or higher.

Please refer to " Page 49 : High Altitude "

Protect the projector with care

When placing the projector at a high position, be sure to secure the projector firmly so that it would not fall and cause injuries. Take care to protect the projector's lens from collision, abrasion or other damages. Be sure to close the lens cover or cover the projector with a dust cover if you need to store the projector or if it will not be used for an extended time.

Keep the projector's ventilation inlets and outlets free from obstructions

Note the direction of air flow at the designated spot of installation. Do not let the hot air released from the outlet flow back to the inlet as it will prevent proper cooling and lead to damage of the projector's internal structure.

In the event of high temperature due to malfunctioning of the internal cooling fan caused by clogging at the ventilation inlets and outlets, the projector will activate its automatic protection mode and shutdown. When this happens, it does not necessary mean that the equipment is malfunctioning. Try to unplug the power cord from the wall outlet and wait for approximately 15 minutes before operating the projector again (remember to remove the objects that have caused poor ventilation so that the projector will not go into the protection mode again).

Description: The regulation of temperature inside the projector by the cooling fan is automatic. And as such, the sound of cooling fan changing its operating speed does not imply that a problem has occurred with the projector.

Warning, Notices and Safety Instructions

If there has the obstacles on projector both sides.

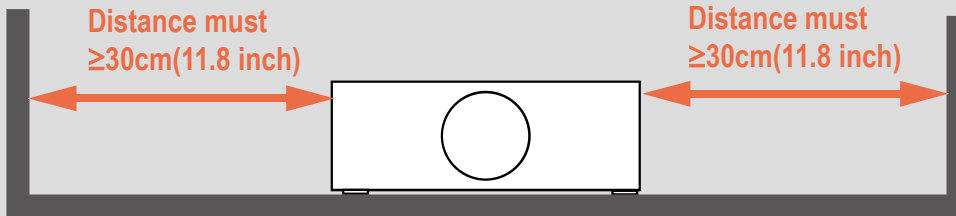

If there has the obstacles on projector both sides.

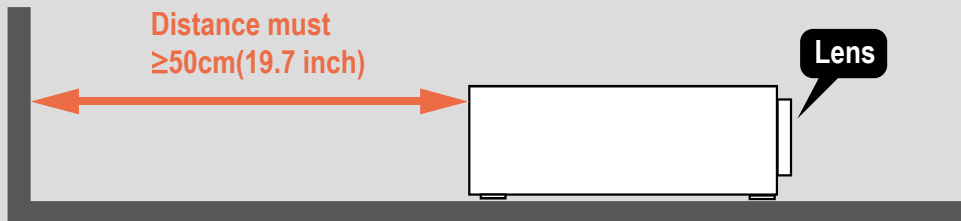

Positioning Precautions

This projector can be installed 360° range (include portrait). But life of optical parts will be shortened as following situation:

- 1.If the projector installed when the lens faces downward.
- 2.If the projector installed when the IO connect side upward at the portrait situation.

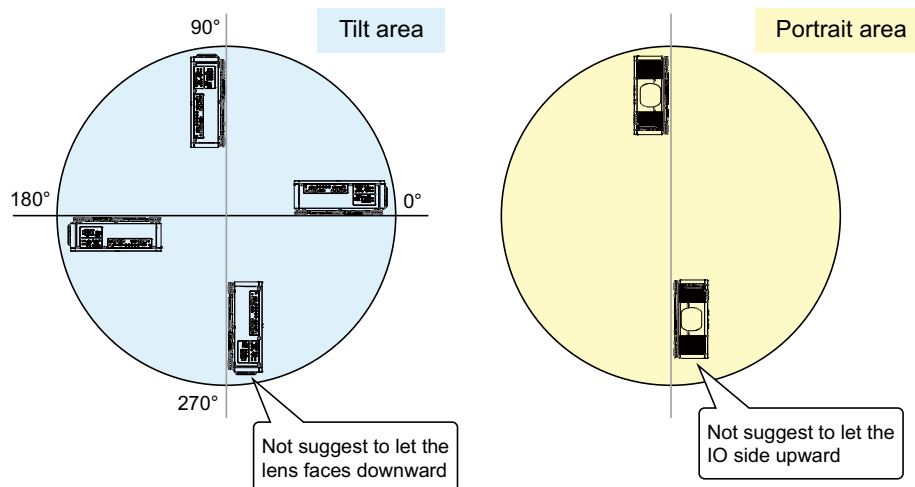

Warning, Notices and Safety Instructions

Caution for 3D

- Don't let children view the 3D by themselves , please always be accompanied by an adult.
- Although more than six years old can view the 3D. But children may not tell you if they are feeling unwell when viewing 3D content, so always be sure to check with the child.
- When viewing 3D content, be sure you are at an appropriate distance from the front of the screen. Suggest keep least three times the height of the screen away from the screen.
- Check that the settings are correct and that the 3D effect is being correctly applied. If the image is inversed and the left and right eye images are swapped, the 3D effect does not work, which could cause eye strain or cause you to feel unwell.

3D content not suitable for below situation, it could aggravate their pre-existing conditions.

- People with a history of photosensitive epilepsy.
- People has heart disease.
- Pregnant women.
- People with serious illnesses.
- People with a history of epileptic seizures.

Suggest stop to view the 3D, if has below situation:

- When you feel unwell , tired, sleep deprived, fatigued or inebriated,
- The 3D image doubled or not clear.
- Enjoying 3D content that rotates, rolls, or shakes, some person may feel they are moving and trigger a form of “sea sickness”.
- Take too long time for viewing 3D content, be sure to take regular breaks to avoid cause eyestrain.

Warning, Notices and Safety Instructions

LASER WARNING



this symbol indicates that there is a potential hazard of eye exposure to laser radiation unless the instructions are closely followed.

CLASS 3R LASER PRODUCT



This Laser Product is designated as Class 3R during all procedures of operation.

LASER LIGHT - AVOID DIRECT EYE EXPOSURE.

Do not point laser or allow laser light to be directed or reflected toward other people or reflective objects .

Direct or scattered light can be hazardous to eyes and skin.

There is a potential hazard of eye exposure to laser radiation if the included instructions are not followed.

Caution – use of controls or adjustments or performance of procedures other than those specified herein may result in hazardous radiation exposure

Laser Parameters

Wavelength	450nm - 460nm (Blue)
Mode of operation	Pulsed, due to frame rate
Pulse width	0.74ms
Pulse repetition rate	240Hz
Maximum laser energy	0.376mJ
Total internal power	>100W
Apparent source size	>10mm, at lens stop
Divergence	>100 mili Radian

Warning, Notices and Safety Instructions

Product labels

Below drawing show the label's location.

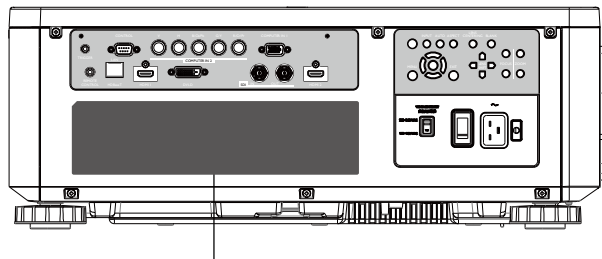

① .Manufacturer's ID

② .Serial No.

③ .Hazard Warning Symbol, Aperture Label, Certification Statement Label and Explanatory Label

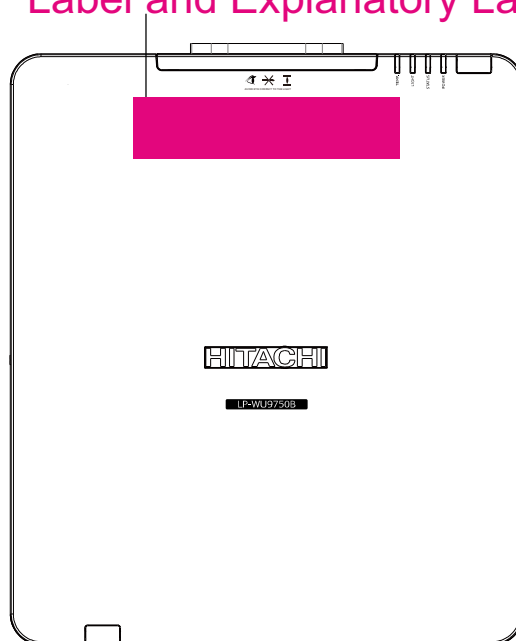

Warning, Notices and Safety Instructions

Manufacturer's ID Label and Serial No. Label.

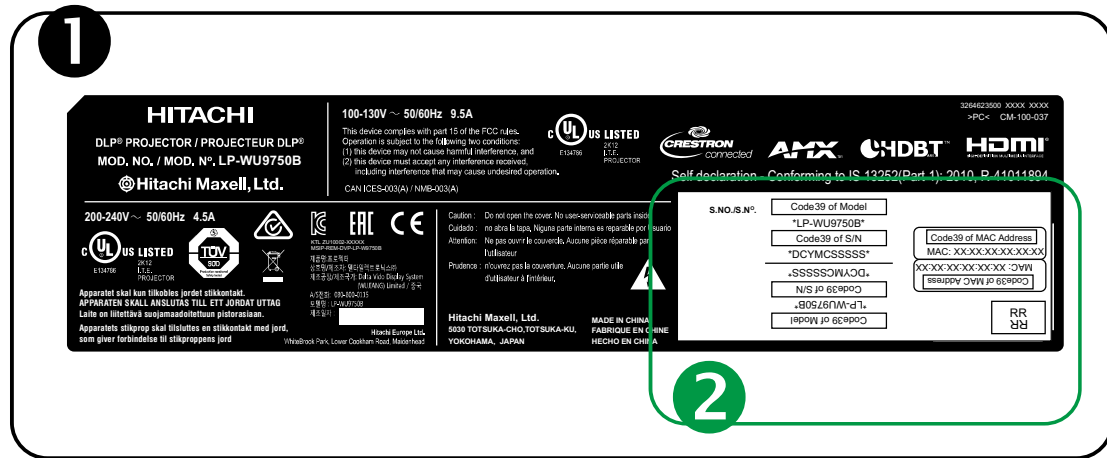

Warning, Notices and Safety Instructions

- a. Hazard Warning Symbol
- b. Aperture Label
- c. Certification Statement Label
- d. Explanatory Label

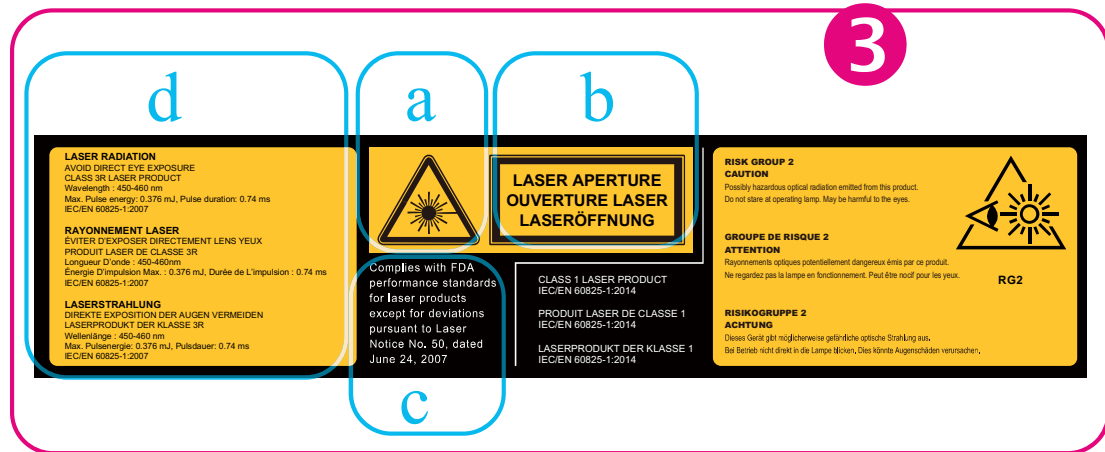

Warning, Notices and Safety Instructions

Location of laser aperture

For eye's safety - Don't stare into the lens, the laser aperture.

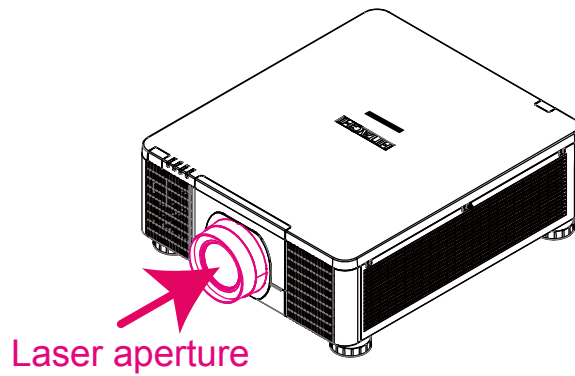

Interlock switches

This product is equipped with interlock switches to further protect end user from laser exposure.

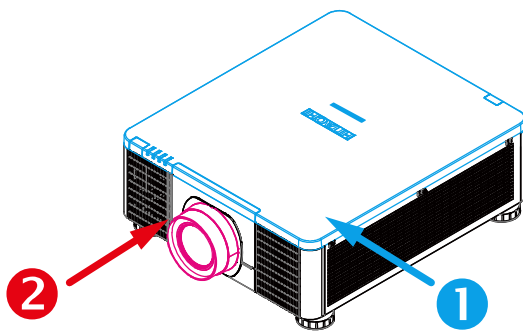

- ❶ Switch will power-off the system when the Top cover is opened.
- ❷ Switch will power-off the system when the lens is removed or not installed correctly.

Warning, Notices and Safety Instructions

Name and quantity of toxic/hazardous substances/elements contained in the product

Please refer to below Table for the names and contents of the toxic or hazardous substances or elements contained in electronic information products.

Marking Styles for Names and Contents of Toxic or Hazardous Substances or Elements

Part Name	Toxic or hazardous Substances and Elements						
	Lead (Pb)	Mercury (Hg)	Cadmium (Cd)	Hexavalent Chromium (Cr(VI))	Polybrominated biphenyls (PBB)	Polybrominated diphenyl ethers (PBDE)	
Optical Engine	○	○	○	○	○	○	
Optical Module	×	○	○	○	○	○	
Fans assy	×	○	○	○	○	○	
Metal bracket	○	○	○	○	○	○	
Plastic bracket	○	○	○	○	○	○	
Metal (Copper Pillars, Copper Nut etc.)	×	○	○	○	○	○	
Temperature switch	○	○	○	○	○	○	
PCB Assy	×	○	○	○	○	○	
Cable	○	○	○	○	○	○	
Power Cord	○	○	○	○	○	○	
Power Inlet	○	○	○	○	○	○	
Remote controller	×	○	○	○	○	○	

O: Indicates that this toxic or hazardous substance contained in all of the homogeneous materials for this part is below the limit requirement in SJ/T11363-2006.

X: Indicates that this toxic or hazardous substance contained in at least one of the homogeneous materials used for this part is above the limit requirement in SJ/T11363- 2006.

(Enterprises may further provide in this box technical explanation for marking "X" based on their actual conditions.)

Projector parts and functions

Front view

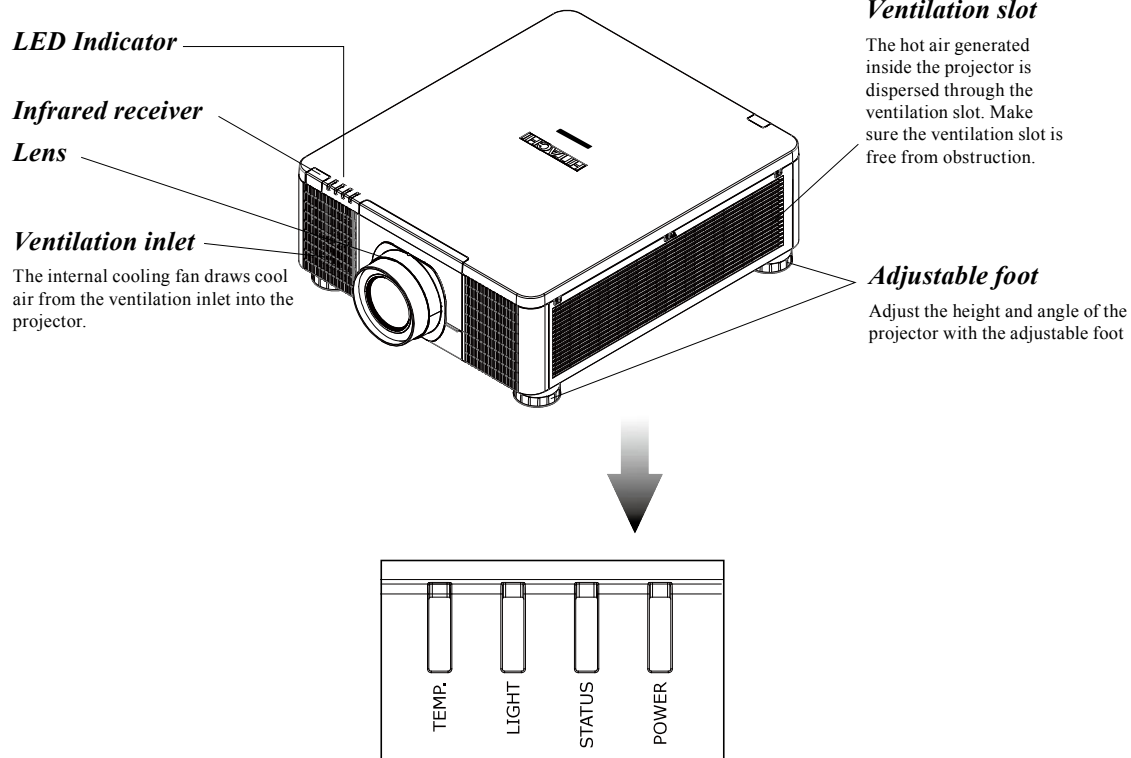

POWER (LED)

The indicator that shows the projector's power status.

STATUS (LED)

The indicator that shows the projector's standby status.

LIGHT (LED)

The indicator that shows the projector is on or off.

TEMP. (LED)

The indicator that shows the projector's error message.

Projector parts and functions

Rear view

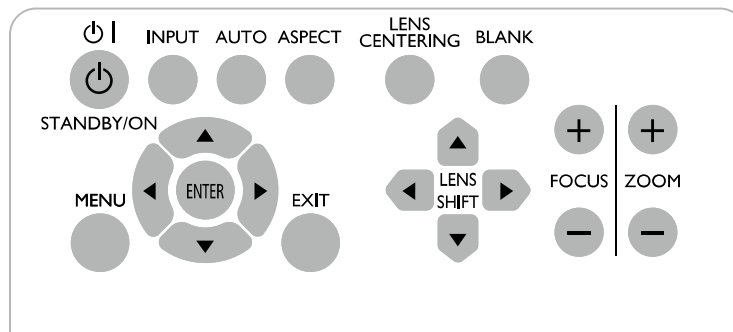
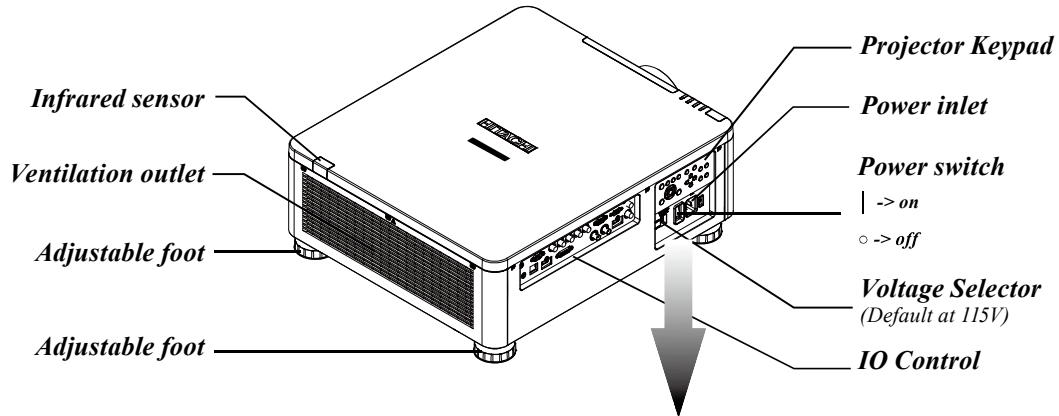

STANDBY.

Use this button to start up or shut down the projector .

INPUT

Used to toggle between different input signal source.

AUTO

Auto adjust the signal synchronization.

ASPECT

Adjust the aspect ratio. Refer to " Page 45 : Aspect "

LENS CENTERING

Press this button to center the lens and calibrate the parameter of lens shift, focusing and zooming.

BLANK

Press this button display the blank image.

MENU

Displays or hides the OSD adjustment screen.

▲▼▶◀ BUTTONS

Use these buttons to scroll, configure or adjust items on the OSD or toggle between different pictures.

ENTER

Press to confirm the changed settings

EXIT

Exit the OSD adjustment screen or return to previous osd level.

LENS SHIFT

Adjust the projected image position.

FOCUS

Adjust the projected image's focus.

ZOOM

Zoom in or zoom out the projected image.

Projector parts and functions

COMPUTER IN 2

Connects to five BNC inputs for PC (R/B/G/H/V) or for component (YPbPr) picture source and channel (Hs, Vs) source.

CONTROL

9-pin D-sub socket. Connects your PC or automatic home theater /control system.

TRIGGER

(3.5-mm, mini phone jack)

Offers 12 (+/- 1.5) V of output for 350mA monitor relay with short circuit protection.

To keep with cover while not in use.

COMPUTER IN 1

Standard 15-pin VGA connection socket to connect to RGB, high-definition component input or PC. The projector will automatically detect the resolution of the input signal.

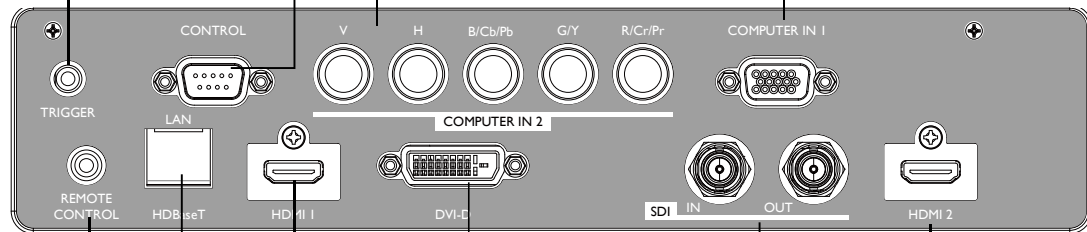

REMOTE CONTROL

Usable wired-remote-control with accessory cable. Available for Niles or Xantech IR repeater systems.

HDBaseT

HDBaseT is a technology to transmit image, sound, ethernet or serial control signal via LAN cable.

SDI IN/OUT

Serial digital interface, use BNC connects input or output the picture.

HDMI 1 & 2

HDCP compatible digital picture input; connects to sources using HDMI or DVI.

DVI-D

Connect to DVI source.

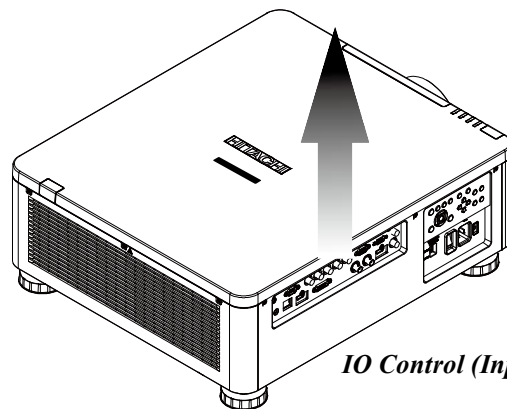

IO Control (Input / Output)

Projector parts and functions

Bottom view

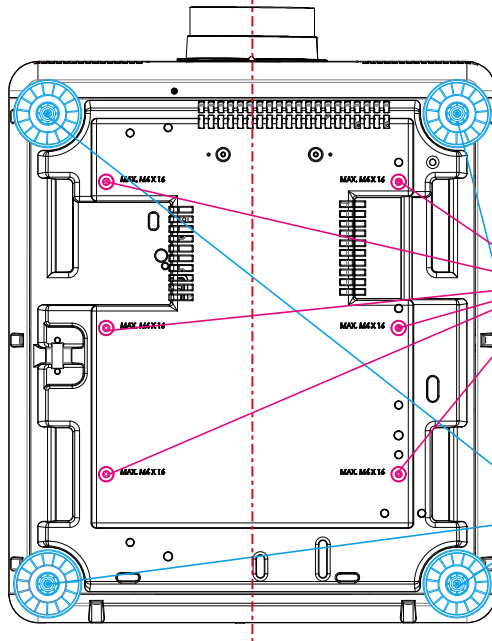
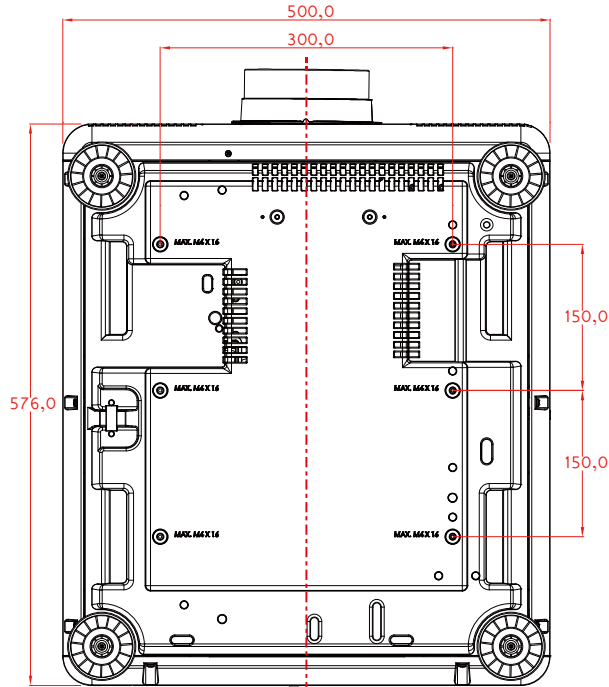

Mounting bracket screw hole

These screw holes are used to mount the projector to its designated mounting bracket using 6 M4x16 screws. The dimensions of the screw holes are shown in the picture below.

Adjustable foot

Adjust the height and angle of the projector with the adjustable foot

Projector parts and functions

Range of effective remote control signal reception

The diagram below illustrates the range of effective remote control signal reception (Unused new battery).

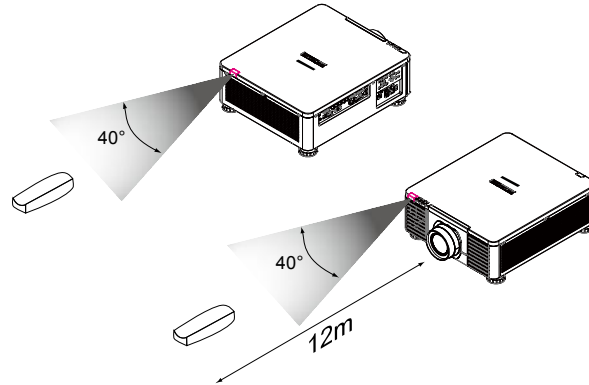

Note: Avoid placing the remote control at places of high temperature or humidity as it could cause the remote control to malfunction.

Installing batteries in the remote control

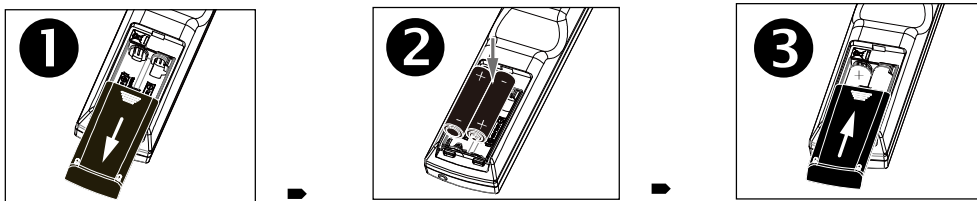

1. Remove the cover by sliding it in the direction indicated by the arrow.
2. Insert two new AA batteries (observe the polarity).
3. Replace the cover.

Note1: Be sure to insert the batteries in the corresponding orientations to match the polarities.

Note2: Do not mix new batteries with used batteries as it would shorten the life of new batteries or cause leakage.

Note3: Only used AA batteries as instructed; do not attempt to insert different types of batteries into the remote control.

Note4: If the remote is going to be unused for long periods of time, be sure to remove the batteries to prevent leakage, which could damage the remote control.

Note5: The liquid contents in the batteries is harmful to the skin; do not touch the leakage with your bare hands directly. When installing fresh batteries, be sure to clean up the leakage thoroughly.

Note6: Under most circumstances, you only need to point the remote control towards the screen and the IR signal would be reflected off the screen and picked up by the IR sensor on the projector. But under specific circumstances, the projector may fail to receive signals from the remote control due to environmental factors. When this happens, orient the remote control at the projector and try again.

Note7: If the range of effective remote control signal reception decreases or if the remote control stops working, replace the batteries.

Note8: If the infrared receiver is exposed to fluorescent lamp or strong sunlight, the remote control may not operate normally.

Note9: Refer to the regulations enforced by your local government on the disposal of used batteries; improper disposal could damage the environment.

Installation of the Projector

Installation the projector.

1. Orient the projector towards the screen

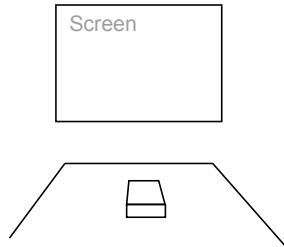

2. Remove the lens PU foam on the projector

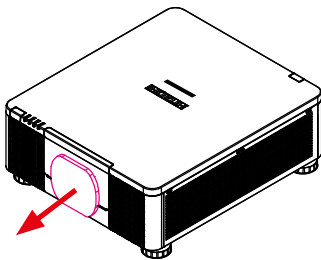

3. Depending on your area, to select the correct input voltage.

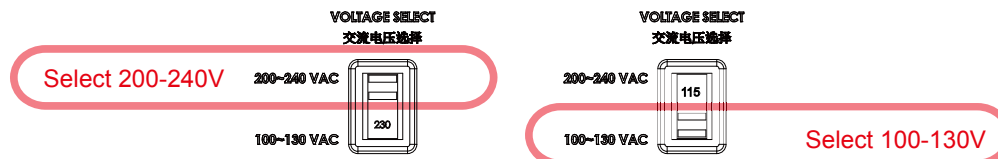

4. Connect the power cord to the projector

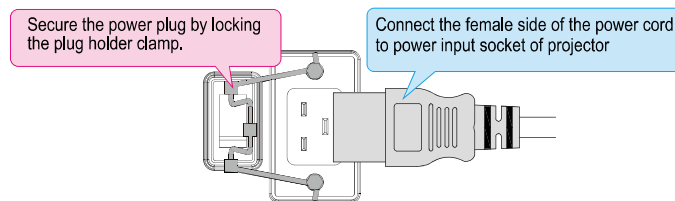

5. Connect the projector to your PC and flip the switch to “I” to turn on the power.

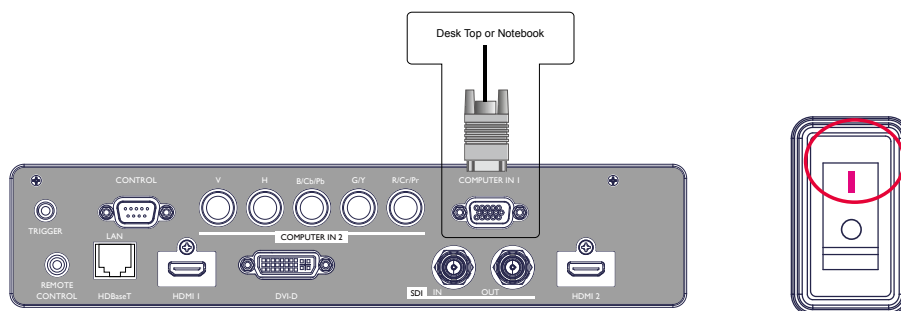

Installation of the Projector

6. Starting the projector up.

Press the  button on the projector or the  button on the remote control to start up the projector.

7. Adjusting the projector's angle, Lens Shift, Zoom and Focus



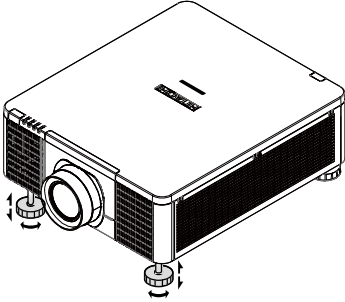

- a. Please use the adjustable feet to change the angle of the projector in order to achieve the most suitable angle for projection on the screen.



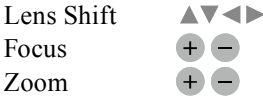





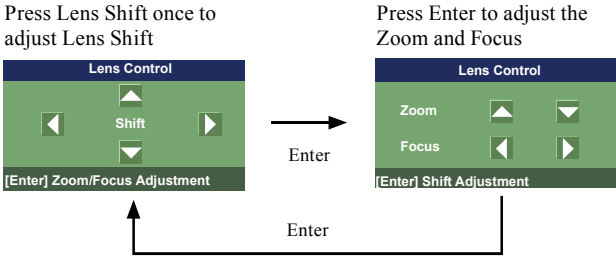

- b. Adjusting the lens by horizontal and vertical lens shift and adjust Zoom and Focus of lens

Method 1: Use the Keypad of







Method 2: Press the  button on the remote control to access Lens Control-Lens Shift. Use the     buttons to adjust the horizontal or vertical position of the lens. Then press **ENTER** to adjust the Zoom and Focus of the lens.



Method 3: Press the  button on the remote control or  Keypad and choose Advanced → Lens Control selected, then use the     buttons to adjust the horizontal or vertical position of the lens. If want to adjust Zoom and Focus. Press  to adjust it.

8. Correcting keystoneing caused by projection angle



- a. To adjust keystoneing, press the **MENU** button on the remote control and choose Advanced → Warping → Keystone adjust and use   buttons to adjust Vertical Keystone. Refer to fig3 on next page.
- b. To adjust keystoneing, press the **MENU** button on the remote control and choose Advanced → Warping → Keystone adjust and use   buttons to adjust Horizontal Keystone. Refer to Fig 4 on next page.

Installation of the Projector

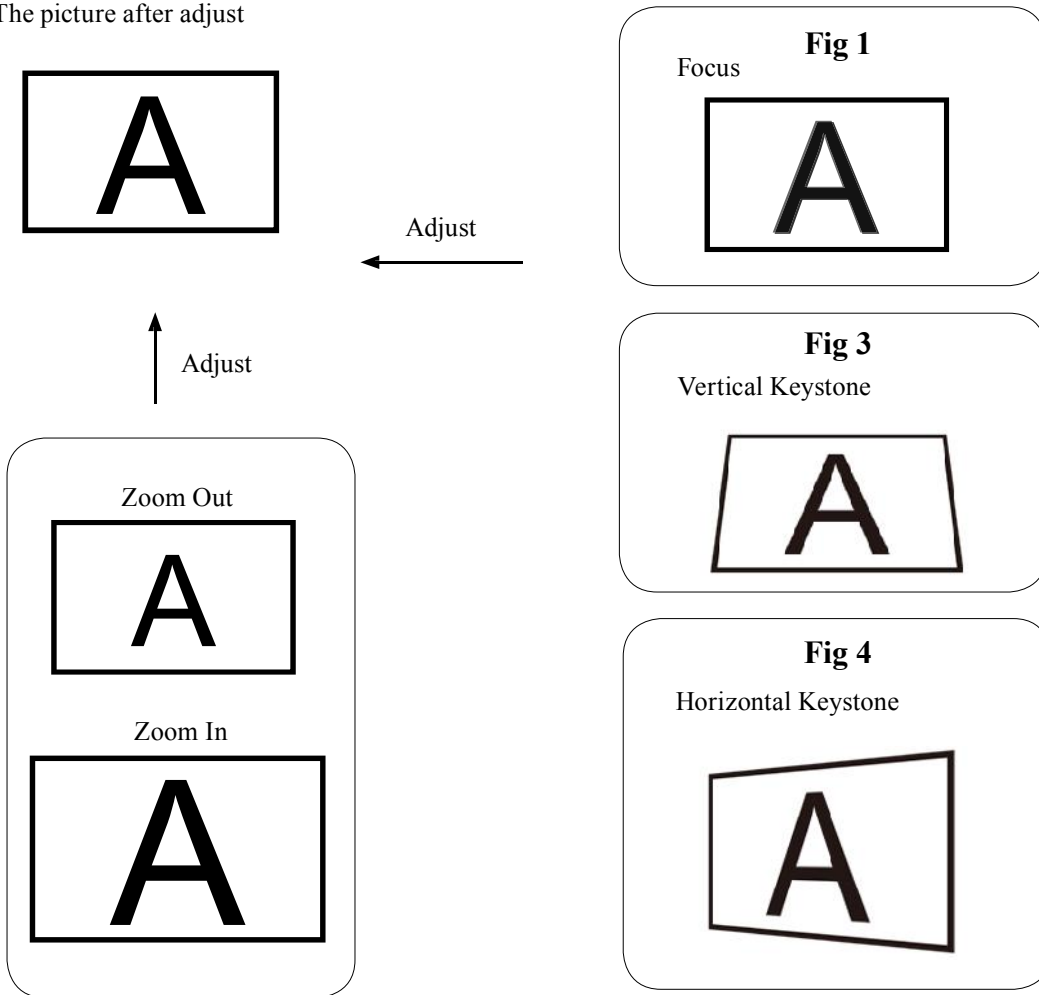
The picture after adjust



9. Turning off the projector

Press the  button on the projector or the  button on the remote control. The message will appear on the screen. Press the button again while the message appears. When the projector has been turned off, the cooling fan will remain in operation for approximately 10 seconds.

Installation of the Projector

Throw distance

Throw Distance (TD) = Screen Width (W) x Throw Ratio (TR)

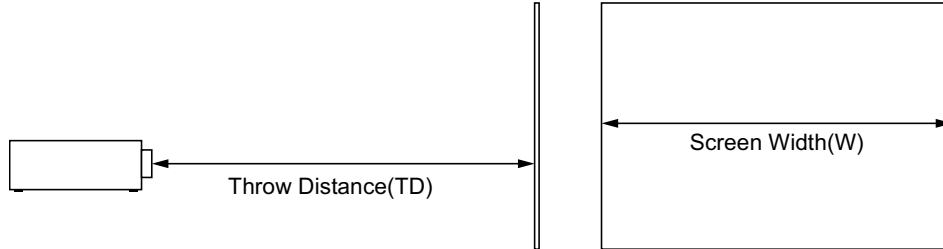

Coupled with the available projection lenses, the projector offers the following throw ratios:

- FL-920(FL-900) (0.32 : 1 100-350inch)
- USL-901 (0.76~0.95 : 1 50-600inch)
- SL-902 (1.14~1.72 : 1 50-600inch)
- SD-903 (1.61~2.44 : 1 50-600inch)
- ML-904 (2.38~3.64 : 1 50-600inch)
- LL-905 (3.47~5.63 : 1 50-600inch)
- UL-906 (5.53~8.79 : 1 50-600inch)

Note:

Projection lenses are optional accessories. Please contact your local dealer to acquire the projection lens that suits your need most.

Modes of installation

- Install the projector in an environment below 40°C (104°F). The projector should be kept clear from sources of heat and / or ventilation openings of air conditioner.
- The projector should be kept away from devices that emit electromagnetic energy, such as motor and transformer. Common devices that emit electromagnetic energy include slideshow system, speakers, power amplifiers and elevators.
- If you choose to install the projector on the ceiling, be sure to use the ceiling installation components manufactured by manufacturer-certified vendors. For details, please contact your local dealer.

Front Tabletop

Advantages: easy to install can be easily moved or adjusted easy to operate.

Disadvantage: occupies floor space and limits seating capacity.

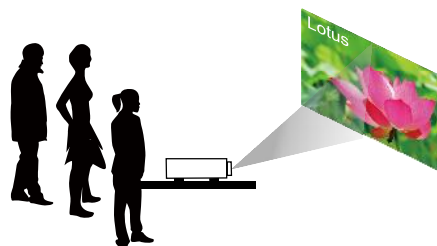

Installation of the Projector

Front Ceiling

Refer to " Page 31 : Front Ceiling "

Advantage: does not occupy floor space does not draw attention to it.

Eliminates the possibility that someone would accidentally move the projector.

Disadvantage: stricter installation requirements and conditions; care should be taken during the installation to ensure the projector has been securely mounted. operation of the projector becomes inconvenient without the remote control.

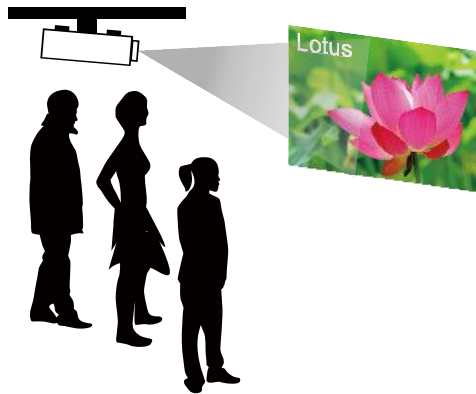

Rear Ceiling

Refer to " Page 32 : Rear ceiling "

Advantage: the projector is completely hidden from plain view this setup usually offers better reduction of ambient noise.

Disadvantage: requires an additional room for installation. Stricter installation requirements and conditions; care should be taken during the installation to ensure the projector has been securely mounted. operation of the projector becomes inconvenient without the remote control.

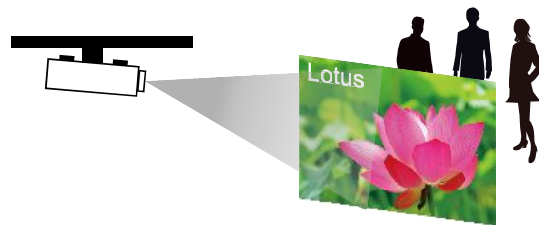

Rear Tabletop

Refer to " Page 31 : Rear Tabletop "

Advantage: the projector is completely hidden from plain view the projector can be easily operated this setup usually offers better reduction of ambient noise.

Disadvantage: requires an additional room for installation relatively higher costs for installation.

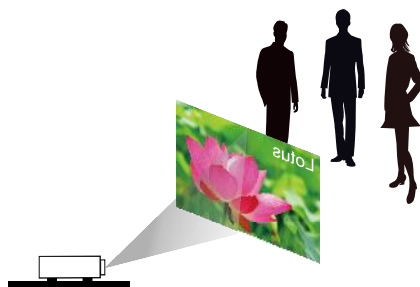

Rear projection - submersive installation

If you wish to have a rear projection setup with limited space to the rear of the projector, you can use a mirror to reflect the light path.

However, both the projector and the mirror have to be precisely located. If you are considering such installation, please contact your dealer for assistance.

Advantage: the projector is completely hidden from plain view this setup usually offers better reduction of ambient noise.

Disadvantage: requires an additional room for installation relatively higher costs for installation.

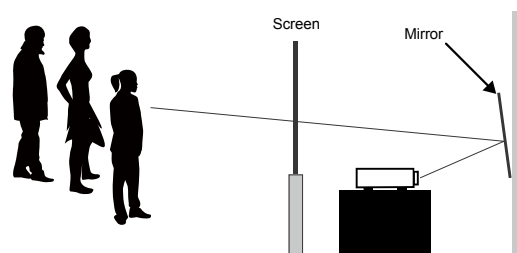

Installation of the Projector

Horizontal and vertical lens shift

In addition to using the adjustable feet to adjust projection angle, you can also use the Lens Shift function to adjust the projected picture.

Moving the lens vertically

The distance of vertical lens movement is +60% , -22% of half the screen height in both directions. For instance, if you are using a 2.03m × 1.27m screen, you will be able to move the picture upwards no more than 63.5cm or downwards no more than 31.8cm.

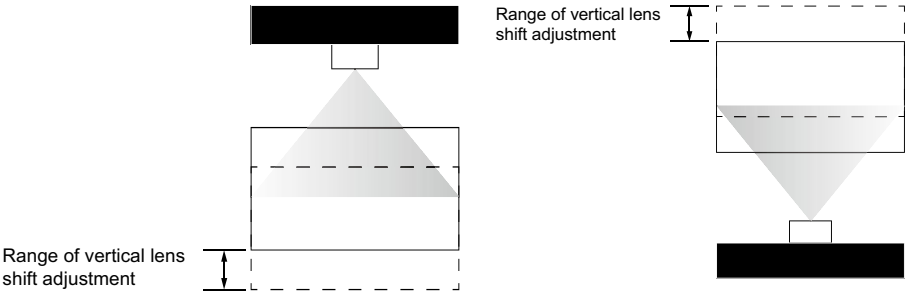

*This illustration shows normal vertical lens shift without the use of special specification lens or projector.
Note: Please make sure the center of lens is rectangular to the center of the screen.*

Moving the lens horizontally

The distance of horizontal lens movement is 20% of half the screen width in both directions. For instance, if you are using a 2.03m × 1.27m screen, you will be able to move the picture left or right by no more than 20.3cm.

H: Range of Horizontal lens shift adjustment

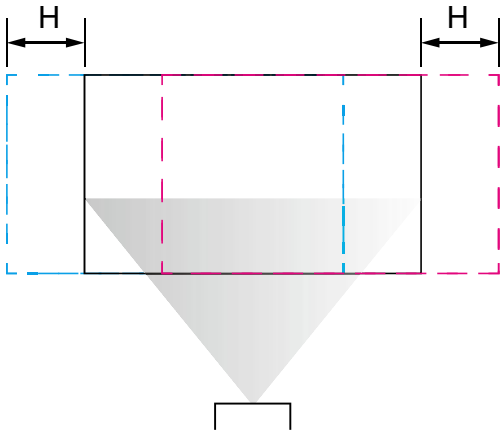

*This illustration shows normal horizontal lens shift without the use of special specification lens or projector.
Note: when the lens is in the neutral position (i.e. without horizontal or vertical shift), the center of the projection should be aligned with the center of the screen.*

Installation of the Projector

Connecting the projector to other devices

HDMI / DVI connection

Signals from picture source offer the best projection picture quality when sent through HDMI/DVI. Therefore, try to use input devices with HDMI/DVI output as the source of picture.

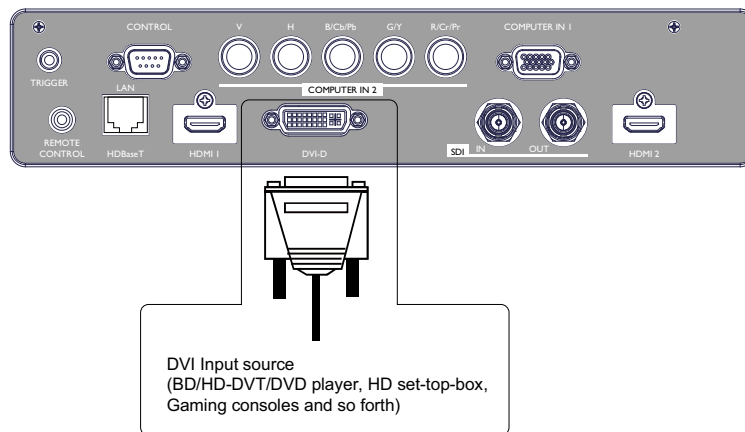
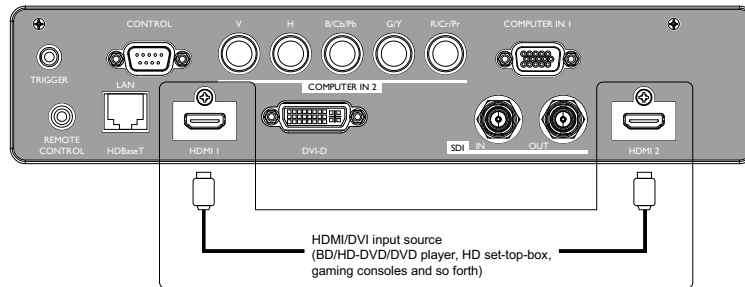

12V Trigger connection

If your home theater system includes a projector screen, screen cover or other 12V Trigger equipment, please connect such device/equipment to the projector's 12V Trigger output as illustrated. After you have done so,

Your screen will lower automatically whenever you turn on your projector for your convenience.

Refer to menu in the CD " Page 57 : Trigger "

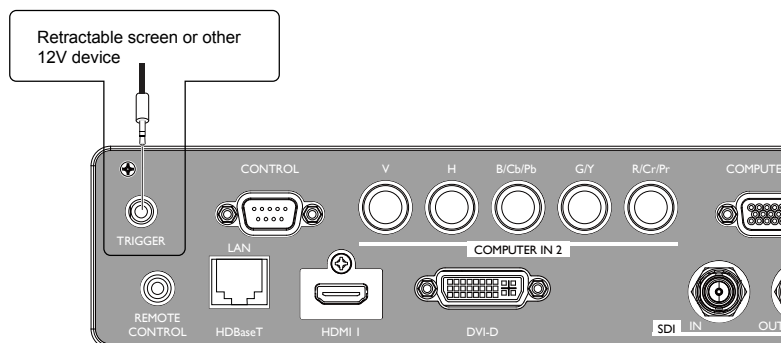

Installation of the Projector

RGB connection

Connect your PC or other devices with RGB output to the RGB input connectors on the projector to be used as the source of picture input.

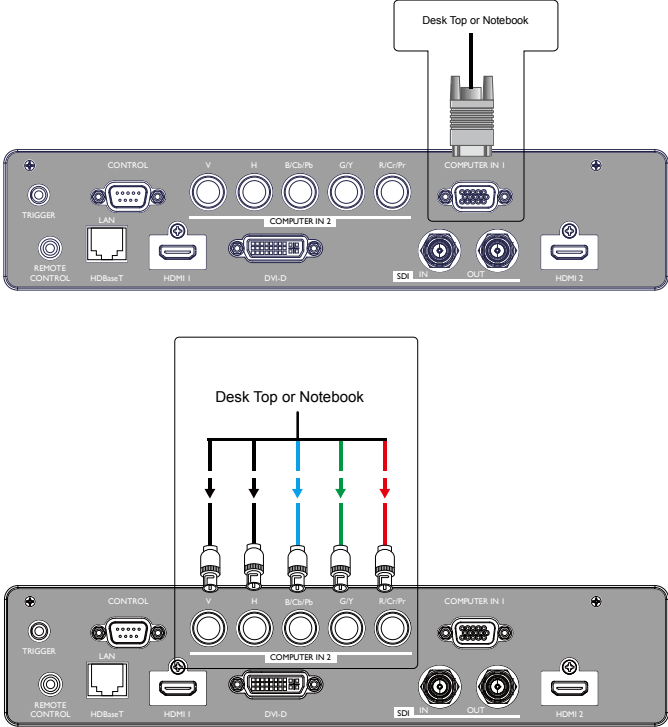

HDBaseT connection

HDBaseT is a technology to transmit image signal using a LAN cable.

Lan Connection - When this connector to be the Lan(RJ-45) function. Connect it to computer or Hub. Key in the correct IP Address or the computer host name which same as the projector's host name then you can remote control the projector by internet.

Video Signal - When this connector to be the video signal input. Connect it to HDBaseT output equipment(Such as high-definition TV source, Blu-ray Player....etc).

Use LAN cables of up to 100m long. Exceeding this length, the image will be deteriorated, and even experience malfunction on LAN transmission.

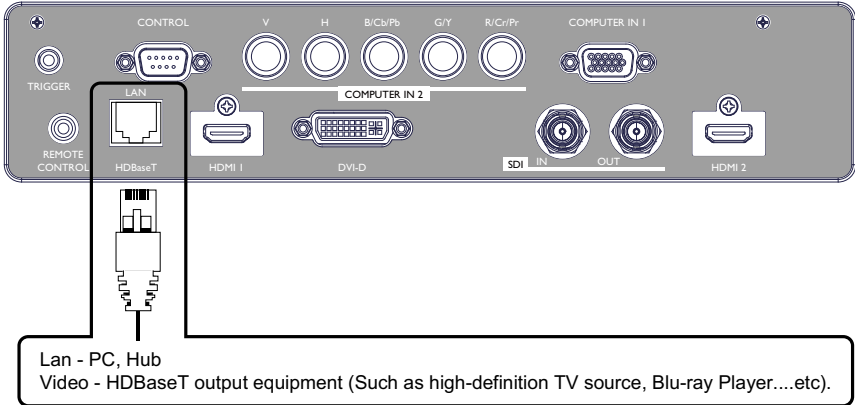

Installation of the Projector

SDI connection

This projector can be connected with other equipment that has SDI connector, but with some equipment the projector may not work properly.

Use a cable of 5CFB or greater (5CFB, 7CFB, and so on), or Belden 1694A or greater to transmit the image properly. Use a cable with a length of 100m or less..

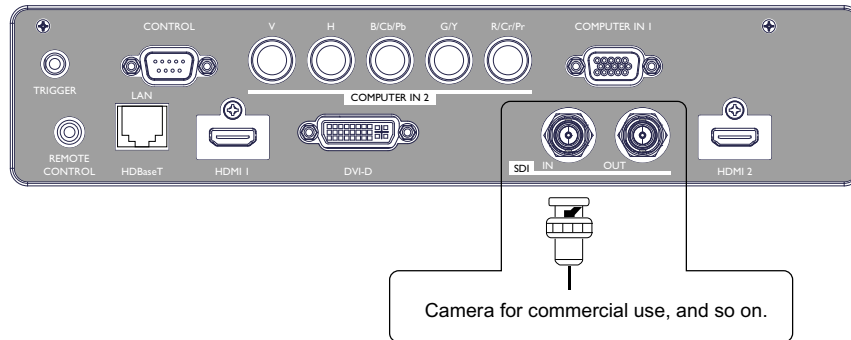

Turning on the projector

Refer to the instructions covered in " Page 22 : Installation the projector. "

Changing OSD language

By factory default, the OSD menu of the projector is displayed in English. If you wish to switch to a different language, you can go to **MENU** → **SETUP** → **Language** and choose the language you prefer for the OSD.

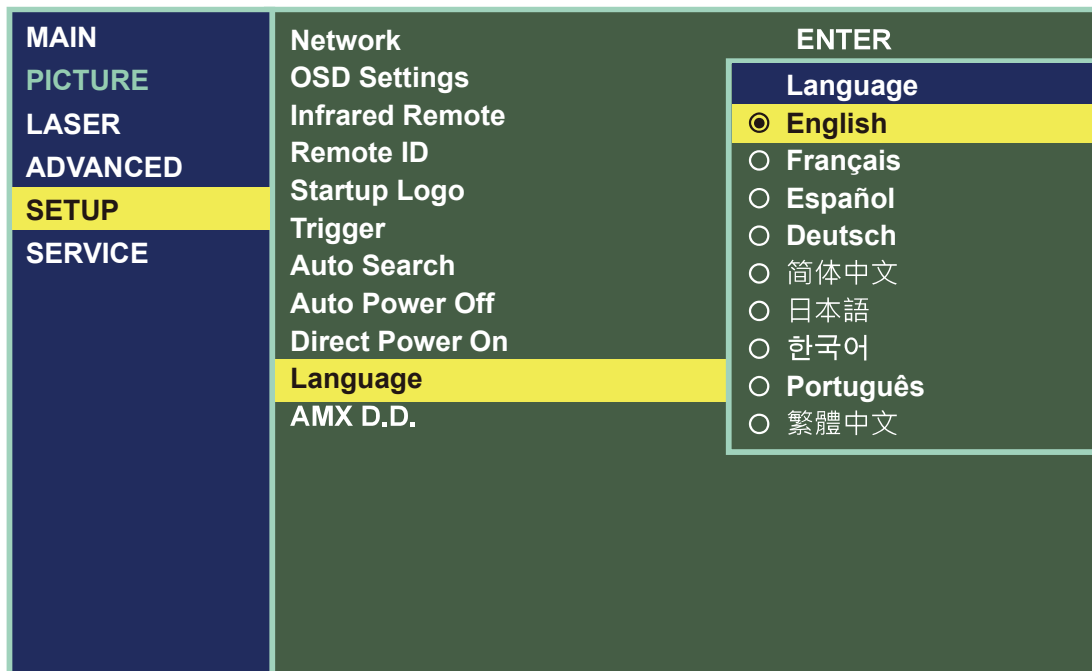

Installation of the Projector

Adjusting screen orientation

By default, the projector is configured for “Front Tabletop”. If you choose to install your projector in other setups, be sure to adjust the screen orientation to achieve the correct projection mode.

MAIN	Installation	Front Tabletop
PICTURE	Lens Control	ENTER
LASER	Lens Memory	ENTER
ADVANCED	Lens Centering	ENTER
SETUP	Gamma	2.2
SERVICE	Pattern	ENTER
	Color Management	ENTER
	Warping Blanking	ENTER
	Edge Blending	ENTER
	Memory Dynamic	ENTER
	Black	ENTER
		Off

Front Ceiling

Press **MENU** → Advanced → Installation → Front Ceiling and choose ON; the projector is now configured for “Front Ceiling”.

Correct Picture

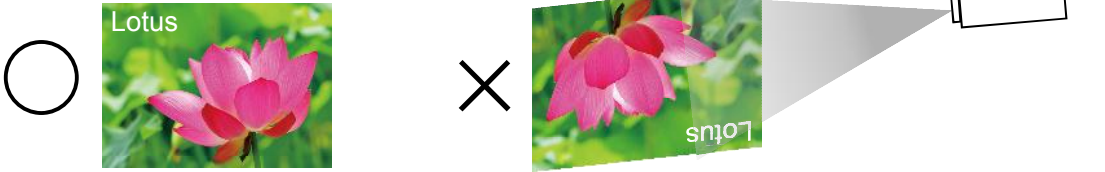

Rear Tabletop

Press **MENU** → Advanced → Installation → Rear Tabletop and choose ON; the projector is now configured for “Rear Tabletop”.

Correct Picture

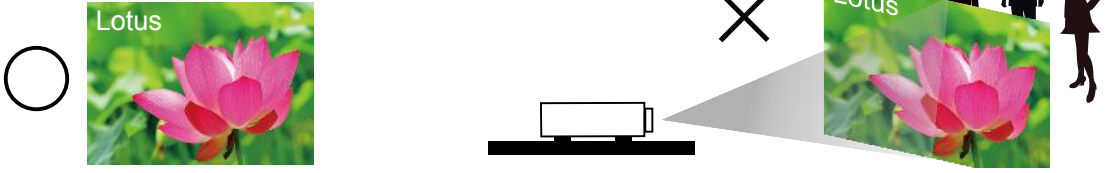

Installation of the Projector

Rear ceiling

Press **MENU** → Advanced → Installation → Rear Ceiling and choose ON; the projector is now configured for “Rear Ceiling”.

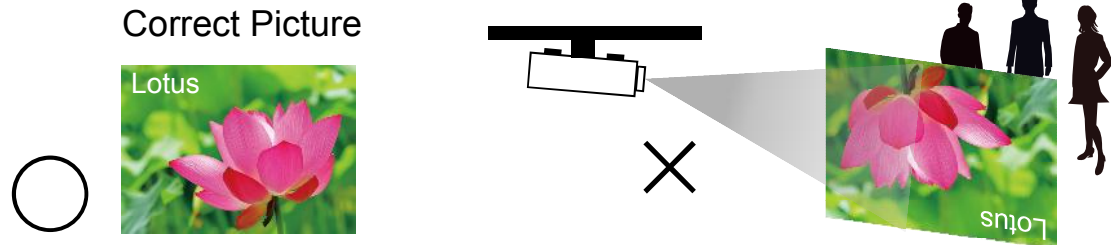







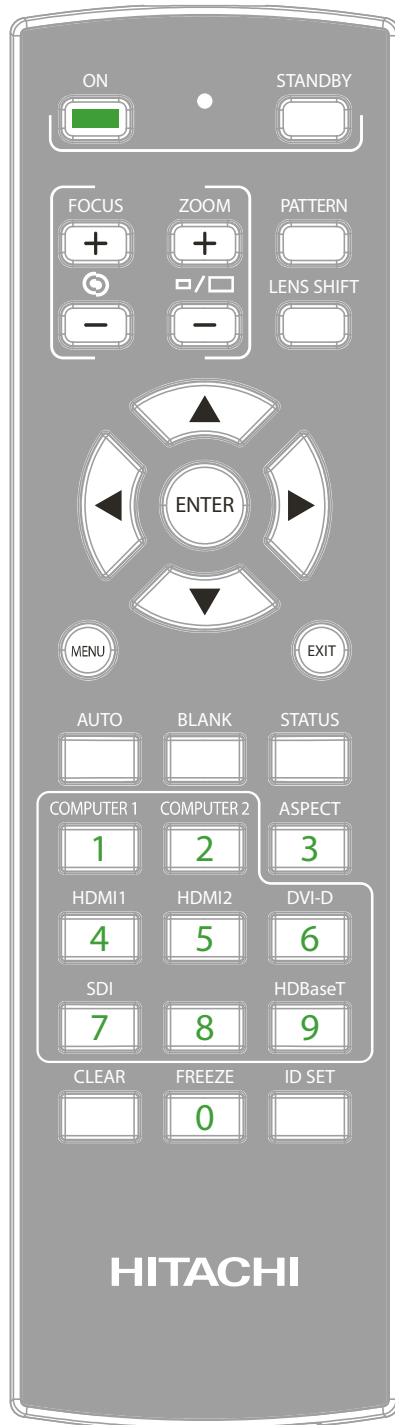













Adjusting the projector lens

Projector lens adjustment includes focus, zoom, horizontal/vertical picture shift. Please refer to " Page 23 : 7. Adjusting the projector's angle, Lens Shift, Zoom and Focus " and " Page 23 : 8. Correcting keystone caused by projection angle " for detailed instructions.





Remote control



1. **ON**  This button is used to turn on the projector.
2. **OFF**  This button is used to turn off the projector.
3. **FOCUS**  Adjust the image focus.
4. **ZOOM**  Adjust the image zoom.
5. **PATTERN**  Repeat press this button to select different test pattern.
6. **LENS SHIFT**  Repeat press this button to adjust the lens focus, zoom and control lens to center.
7. **ARROR KEY**  Use these buttons to make your selection or configure, adjust configuration or toggle between picture displays.
8. **ENTER**  Use this button to select items in the menu or confirm the settings you have changed.
9. **MENU**  Press this button to show or hide the OSD Menu.
10. **EXIT**  Press this button to exit , hide the OSD Menu or return to previous OSD Menu level.
11. **AUTO**  This button is used to Resync the picture; when the picture signal becomes unstable or picture quality deteriorates simply press this button and the projector will automatically adjust the screen dimension, phase, timing and so forth.(The adjustments also apply to PinP input).
12. **BLANK**  If the projector projected on the whiteboard. and you need to write something on the whiteboard. You can press this button let the projector not display anything and protect your eyes.
13. **STATUS**  Display the projector's information. Same as the OSD -> Service.
14. **ASPECT**  You can scroll through different aspect ratios by pressing this button repeatedly. Refer to " Page 45 : Aspect "
15. **COMPUTER 1**  Hotkeys to select the input source - Computer 1.
16. **COMPUTER 2**  Hotkeys to select the input source - Computer 2.
17. **HDMI 1**  Hotkeys to select the input source - HDMI 1.
18. **HDMI 2**  Hotkeys to select the input source - HDMI 2.
19. **DVI-D**  Hotkeys to select the input source - HDMI 2.
20. **SDI**  Hotkeys to select the input source - SDI.

REMOTE CONTROL

REMOTE CONTROL

21. **HDBaseT** 
 Hotkeys to select the input source - HDBaseT.
22. **FREEZE** 
 Press this button to freeze the projected image. But Sound still keep going. Only effect image.
23. **NUMBER KEY (0-9)**
 
 Only available for ID Set when these button to be the number keys.
24. **ID SET** 
 This function is for set the projector and Remote control's ID. The projector can set ID 01-99. After setup different ID, the remote control will only can control projector 1 by 1. Can't control other projector.
- Press "ID SET + MENU" together for 5 seconds, the remote control backlight will flash one time, then prepared the ID Set mode. Press "ID SET + MENU" for 5 seconds (backlight will flash 1 time) to release ID Set mode.
- After prepared the ID Set mode. press ID SET for 3 seconds. The remote control LED light will start flash and remote control backlight lights. Mean you can press number 0-9 to set the projector's ID. Example 1, press "0" for 1 second (LED light flash 3 times), then press "1" for 1 second(LED light flash 3 times then backlight off). success to set the projector ID 01. Example 2, press "1" for 1 second, then press "9" for 1 second. Success to set the projector ID 19.
- Note: This feature is disabled if the device is setting 00 to be the initial value.*
25. **CLEAR** 
 Press "ID SET + CLEAR" for 5 seconds(Remote control backlight flash 1 time) to release the ID SET setting.

Remote control
backlight

LED light

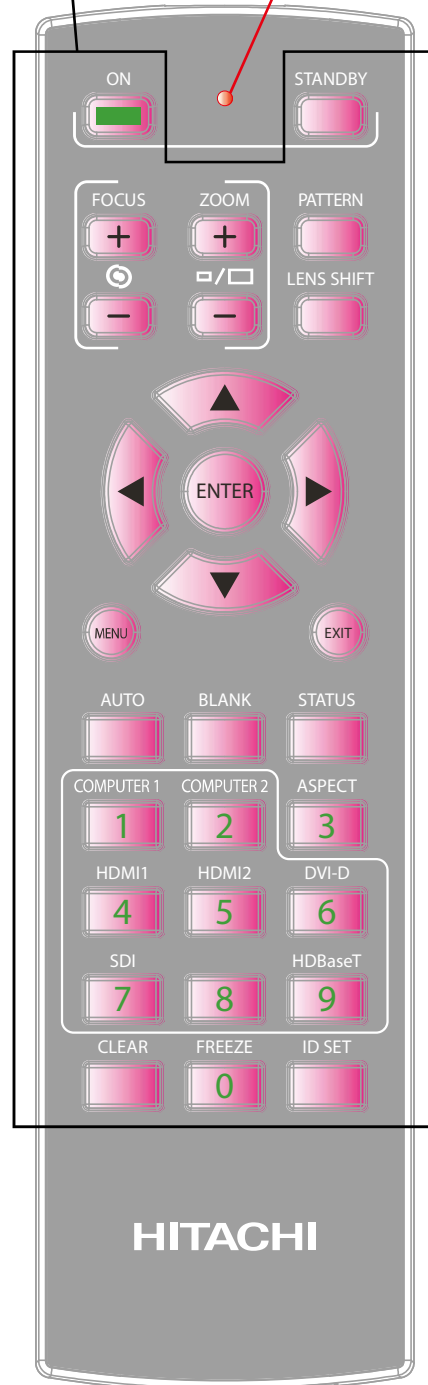

OSD Menu description

OSD Menu Tree

1st layer	2nd layer	3rd layer	4th layer	Selections
MAIN	Input			HDMI1 / HDMI2 COMPUTER IN 1 / COMPUTER IN 2 HDBaseT / SDI / DVI-D
		PinP		On / Off
	PinP Selection			HDMI1 / HDMI2 COMPUTER IN 1 / COMPUTER IN 2 HDBaseT / SDI / DVI-D
		PinP Position		Top Left / Top Right Bottom Left / Bottom Right PbyP
	Color Space			Auto REC709 / REC601 RGB PC / RGB Video
		3D	3D Format	
	Eye Swap			Normal / Reverse
	DLP Link			On / Off
	Magnify & Shift	Magnify		0 ~ 100
		Horz Shift		-480 ~ 480 (Dynamic)
		Vert Shift		-300 ~ 300 (Dynamic)
		RESET		(Execute)
	No Signal			Logo / Black Blue / White

1st layer	2nd layer	3rd layer	4th layer	Selections	
Picture	Picture Mode			High Bright / Presentation Video	
		Brightness		0 ~ 200	
	Contrast		0 ~ 200		
	Color		0 ~ 200		
	Tint		0 ~ 200		
	Sharpness		0 ~ 20		
	Noise Reduction		0 ~ 3		
	Color Temperature			5400K / 6500K 7500K / 9300K Native	
		White Balance	Red Offset		0 ~ 200
	Green Offset			0 ~ 200	
	Blue Offset			0 ~ 200	
	Red Gain			0 ~ 200	
	Green Gain			0 ~ 200	
	Blue Gain			0 ~ 200	
	Aspect			4:3 / 16:10 16:9 / Normal Native	
		Over Scan		Off / Crop / Zoom	
	Position and Phase		V Position		0 ~ 200 (Dynamic)
			H Position		0 ~ 200 (Dynamic)
		H Phase		0 ~ 200	
		H Size		0 ~ 200 (Dynamic)	
Auto Adjust			(Execute)		

1st layer	2nd layer	3rd layer	4th layer	Selections
Laser	Power Mode			ECO / Normal / Custom
	Power Level			20% ~ 100%
	High Altitude			Normal / High 1 / High 2 / Auto

OSD Menu description

1st layer	2nd layer	3rd layer	4th layer	Selections	
Advanced	Installation			Front Tabletop / Front Ceiling Rear Tabletop / Rear Ceiling	
	Lens Control			Zoom/Focus Shift	
	Lens Memory	Load Memory		Memory 1 / Memory 2 Memory 3 / Memory 4 Memory 5	
		Save Memory		Memory 1 / Memory 2 Memory 3 / Memory 4 Memory 5	
		Clear Memory		Memory 1 / Memory 2 Memory 3 / Memory 4 Memory 5	
	Lens Centering			(Execute)	
	Gamma			1.0 / 1.8 / 2.0 / 2.2 / 2.35 / 2.5 / DICOM SIM.	
	Pattern	Selecting by cursor button in OSD menu. Escaping by EXIT button.		White / Black / Red Green / Blue / Checkerboard CrossHatch / V Burst H Burst / ColorBar	
	Color Management	Red / Green / Blue Cyan / Magenta Yellow	Hue	0 ~ 200	
			Saturation	0 ~ 200	
			Gain	0 ~ 200	
		White	Red Gain	0 ~ 200	
			Green Gain	0 ~ 200	
			Blue Gain	0 ~ 200	
	Warping	Keystone		Horizontal -600 ~ +600 Vertical -400 ~ +400	
		Rotation		-100 ~ 100	
		Pincushion / Barrel		Horizontal -150 ~ 300 Vertical -150 ~ 300	
		Top Left Corner			192<X<-192 120<Y<-120
			Top Right Corner		192<X<-192 120<Y<-120
					192<X<-192 120<Y<-120
			Bottom Left Corner		192<X<-192 120<Y<-120
				192<X<-192 120<Y<-120	
		Reset		(Execute)	
		Blanking	Top		0 ~ 360
	Bottom			0 ~ 360	
	Left			0 ~ 534	
	Right			0 ~ 534	
	Reset			(Execute)	
	Edge Blending	Status		On / Off	
		Blending Region	Top / Bottom	0 / 100 ~ 500	
			Left / Right	0 / 100 ~ 800	
		Blending Level	Top / Bottom Left / Right	0 ~ 32	
			All / Red Green / Blue	0 ~ 255	
			Reset	(Execute)	
		Adjust Lines		On / Off	
	Memory	Load Memory		Preset A / Preset B / Preset C Preset D / Default	
		Save Settings		Preset A / Preset B Preset C / Preset D	
		Clear Settings		Preset A / Preset B Preset C / Preset D	
	Dynamic Black			On / Off	

OSD Menu description

1st layer	2nd layer	3rd layer	4th layer	Selections
Setup	Network	Network Mode		Projector Control / Service
		Standby Power		On / Off
		DHCP		On / Off
		IP Address		xxx.xxx.xxx.xxx
		Subnet Mask		xxx.xxx.xxx.xxx
		Gateway		xxx.xxx.xxx.xxx
		DNS		xxx.xxx.xxx.xxx
		MAC Address		xxx.xxx.xxx.xxx
	OSD Settings	Menu Position		Top Left / Top Right Bottom Left / Bottom Right Center
		Time Out		Always On / 10 Seconds 30 Seconds / 60 Seconds
		Message Box		On / Off
	Infrared Remote			On / Off
	Remote ID			0 ~ 99
	Startup Logo			On / Off
	Trigger			Screen / 4:3 / 16:10 16:9
	Auto Search			On / Off
	Auto Power Off			On / Off
	Direct Power On			On / Off
	Language			English / French / Spanish German / Chinese Simplified Japanese / Korean Portuguese / Traditional Chinese
	AMX D.D.			On / Off

1st layer	2nd layer	3rd layer	4th layer	Selections	
Service	Model Name				
	Serial Number				
	Software Version 1				
	Software Version 2				
	Active Source				
	Signal Format	Timing			
		H Freq			
		V Freq			
		Pixel Clock			
	Laser Hours				
	Thermal Status	Intake Temp.			
		DMD Temp.			
		Laser Temp.			
	Lens Information		1: USL-901		
			2: SL-902		
			3: SD-903		
			4: SD-903W		
		5: ML-904			
		6: LL-905			
	7: UL-906				
	8: FL-920				
	0: Unknown				
Factory Reset	(Execute)				

OSD Menu description

OSD Description

1. Press the MENU button on the remote control or on the side of the projector to bring up the OSD Menu.
2. You will see six functional menus (Main, Picture, Laser, Advanced, Setup and Service). Press ◀ or ▶ to select the desired sub menu.
3. Press ▲ or ▼ to select the desired sub menu.
4. Your current selection in each of the sub menu will be displayed in black text and highlighted in orange. Press ▶ or ENTER to access the configuration for the selected item or press ENTER to go to another sub menu.
5. Press MENU to return to the previous menu.
6. From the main menu, press MENU to close the OSD Menu.
7. Some items do not work at the condition of Source, Input signal and Menu setting.
8. Picture may be incorrect when the parameter value is exceeded.

MAIN

MAIN	Input	DVI-D
PICTURE	PinP	Off
LASER	PinP Selection	HDMI 2
ADVANCED	PinP Position	Top
SETUP	Color Space	Right
SERVICE	3D	Auto
	Magnify & Shift	ENTER
	No Signal	ENTER
		Logo

Input

This function is same as the hotkey which on Remote controller. You can use remote controller or this function to select the correct input source.

- **HDMI1/HDMI2**
HDMI input from PC or media device.
- **Computer In 1**
Analog RGB from PC.
- **Computer in 2 / 5BNC**
Analog interface from media device.
- **HDBaseT**
Uncompressed digital video from RJ45.
- **SDI**
Uncompressed digital video from a serial connection (coaxial).
- **DVI-D**
DVI input from PC.

OSD Menu description

PinP

If you wish to display PinP picture (Picture in Picture), you can make the configuration here. By choosing "ON", you will see two windows on the projected picture; the larger one is the primary picture and the smaller one is the sub picture. By choosing "OFF", the PinP function will be disabled and you will only see a single picture window.

please refer to the following main and PinP source matrix for a valid main and PinP source selection when PinP is ON.

PinP/Main Source Availability		MAIN SELECT						
		COMPUTER IN 1	COMPUTER IN 2	HDMI 1	HDMI 2	DVI-D	HDBaseT	SDI
PIP SELECT	COMPUTER IN 1			V		V	V	
	COMPUTER IN 2			V		V	V	
	HDMI 1	V	V		V			V
	HDMI 2			V		V	V	
	DVI-D	V	V		V			V
	HDBaseT	V	V		V			V
	SDI			V		V	V	

V -> Source available
Empty -> Not available

PinP Selection

Use this function to select the sub picture's input source. Refer to " Page 38 : Input " for detail information.



PinP Position

You can choose to display the sub window in five different location over the main picture according to your preference.

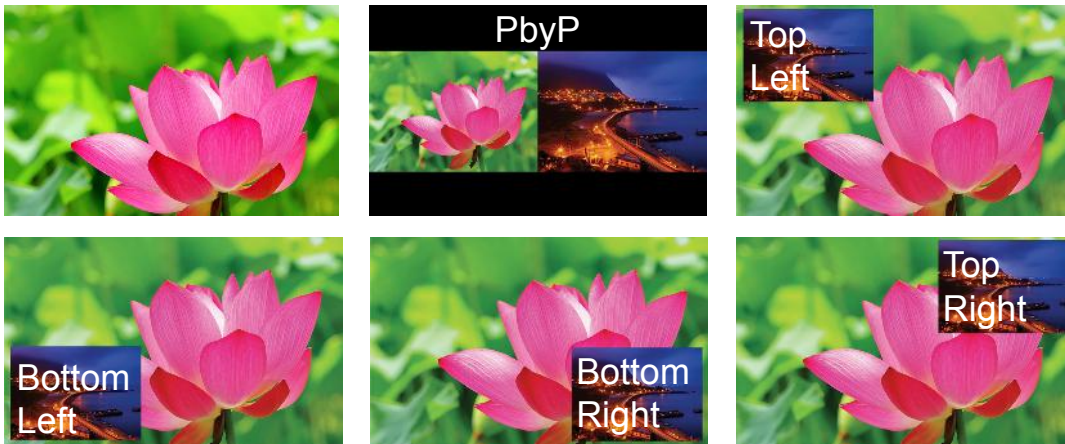

OSD Menu description

Color Space

Select Color Space from the Advanced menu to choose the color space of the source signal for HDMI, COMPUTER IN, and component connections.

The default setting, Auto, functions as follows:

- **Auto**
The Auto setting determines the correct color space to be used automatically. For HDMI input, this determination is based on the AVI infoframe conveying in the input signal. For other input sources, this determination is based on the timing format of the input signal, for PC/IT formats, RGB color space will be used, for CE/Video formats, REC601 or REC709 will be used. If the auto setting does not determine a correct color space matching the input source signal for some reason, you can force the Projector to use a specific color space. Choose one of the following:
- **REC709**
sets the color space matrix to that defined in ITU-R BT.709.
- **REC601**
sets the color space matrix to that defined in ITU-R BT.601.
- **RGB PC**
uses RGB color space and sets black at 0,0,0 RGB and white at 255,255,255 RGB.
- **RGB Video**
uses RGB color space and sets black at 16,16,16 RGB and white at 235,235,235.

Note: When SDI input is selected, this function is not available.

3D

For setting the 3D Video each value.

- **3D Format**
Default is "Auto". When 3D image is not display. Mean the input signal does not contain 3D detection signal or it can't be detected by the projector. This time, you need to select the correct 3D format manually. There has Off / Auto / Side by Side (Half) / Top and Bottom / Frame Sequential can choice.
- **Eye Swap**
Choice "Normal" or "Reverse" to display the correct picture.
- **DLP Link**
This projector only support DLP Link glasses. If your 3D Glasses is not DLP Link format, set this function "Off".

Magnify & Shift

- **Magnify** : Zoom in the projected image.
- **Horz Shift** : Horizontal direction to shift the projected image.
- **Vert Shift** : Vertical direction to shift the projected image.
- **Reset** : Clear all settings of Magnify & Shift.

No Signal

Use this function to specify the content or color to be displayed on the blank screen when no input signal is available. You can choose from **Logo**, **Blue**, **Black**, **White**. The default value is **Logo**.

OSD Menu description

PICTURE

MAIN	Picture Mode	Video
PICTURE	Brightness	100
LASER	Contrast	100
ADVANCED	Color	100
SETUP	Tint	100
SERVICE	Sharpness	10
	Noise Reduction	0
	Color Temperature	5400K
	White Balance	ENTER
	Aspect	Normal
	Over Scan	Off
	Position and Phase	ENTER
	Auto image	Execute

Picture Mode

Use ◀▶ to select the display mode.

- **High Bright**
When projector in the high ambient light conditions. You can select this mode to get the high brightness image Performance.
- **Presentation**
When projector is in the office to do the presentation. You can select this mode. This mode brightness is between High Bright and Video.
- **Video**
When projector in the low ambient light condition, You can select this mode to save power and optimized image quality.

Brightness

Use ◀▶ to adjust the brightness of the projected picture. You can connect the projector to an external picture source to display an picture resembling the one shown (PLUGE : Picture Line-Up Generation Equipment) for adjustment. Although there are numerous versions of PLUGE picture, they are typically comprised of blocks of black, white and gray on top of a black background.

OSD Menu description

It is recommended that you adjust the picture to the following status:

- The darkest black bar of the picture should disappear into the background.
- The dark gray area should be barely visible.
- The light gray area should be clearly visible.
- The white area should appear real and mellow.
- The picture should only display black, gray and white (with no other colors).

Contrast, Brightness, Color and Tint are interrelated options that affect one another; when you adjust one of them, you might have to fine tune other settings to get the best projection results.

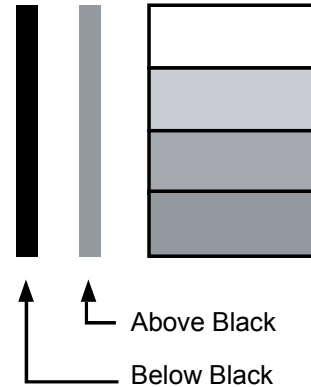

The picture fig 5 illustrates the results of direct brightness adjustment using a random picture:

Contrast

Use ◀▶ to adjust the contrast of the projected picture. You can connect the projector to an external picture source to display an picture resembling the one shown below for adjustment. It is recommended that you adjust the projected picture according to the results shown below so that the brightness of the spectrum remains constant throughout and achieve maximum contrast between black and white.

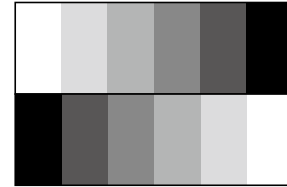

The picture fig 6 illustrates the results of direct contrast adjustment using a random picture:

Color

Use ◀▶ to adjust the color saturation of the projected image.

The picture fig 7 illustrates the results of direct brightness adjustment using a random picture:

Tint

Use ◀▶ to adjust the ratio of red to green in the color portion of the image.

The picture fig 8 illustrates the results of direct brightness adjustment using a random picture:

Sharpness

The adjustment of sharpness primarily changes the value of high frequency detail. You can connect the projector to an external picture source to display a picture resembling the one shown below to adjust the picture sharpness.

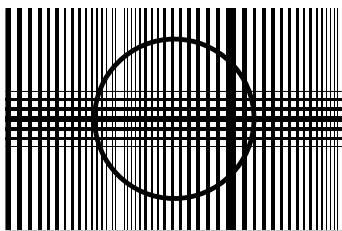

The picture fig 9 illustrates the results of direct sharpness adjustment using a random picture:

OSD Menu description

Noise Reduction

Use ◀▶ to adjust the noise of the projected picture. This function is suitable for the elimination of picture noise from interleaving SD input. Generally speaking, reducing picture noise will lower the value of high frequency detail and make the picture appear more mellow. Refer to Fig 10.

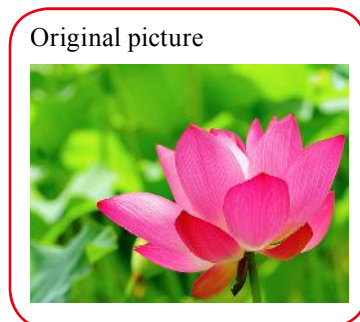
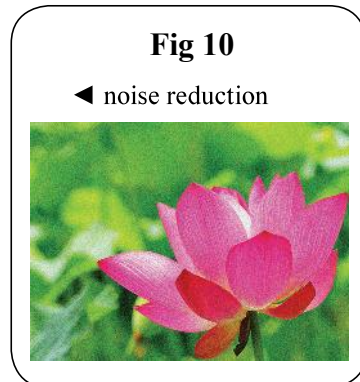
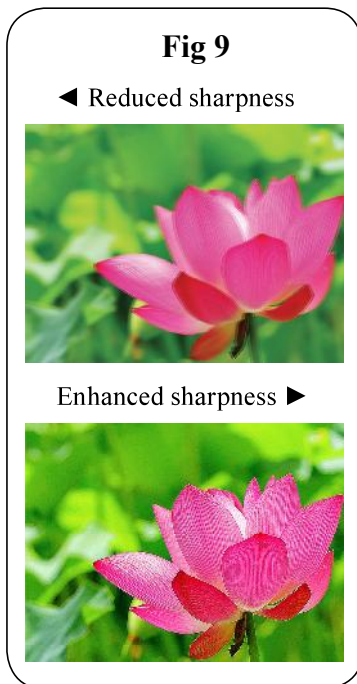
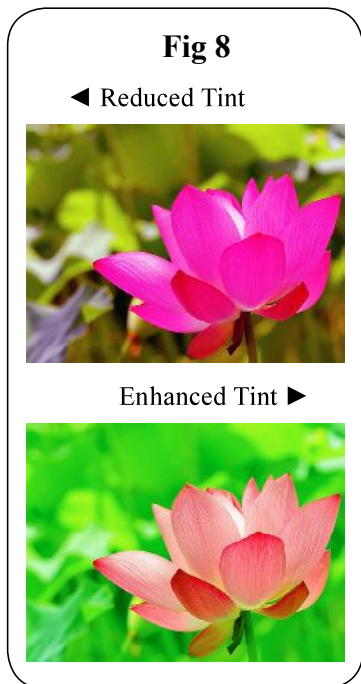
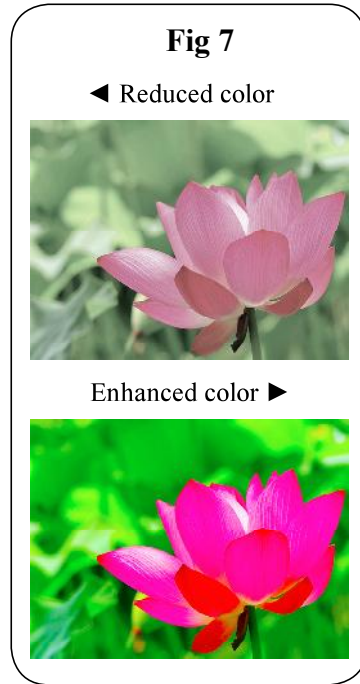
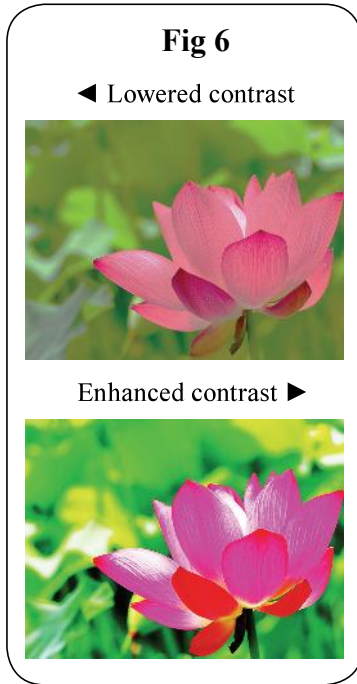
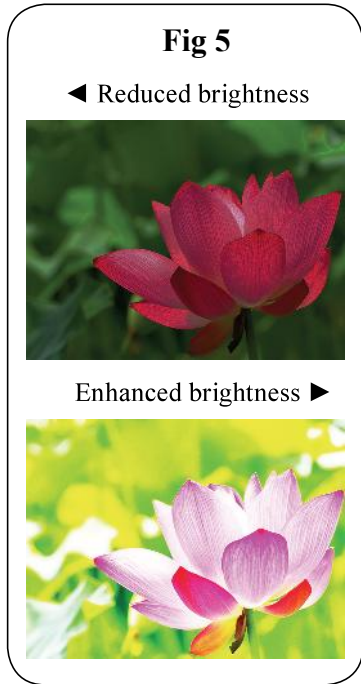

OSD Menu description

Color Temperature

You can choose from **5400K, 6500K, 7500K, 9300K and Native**.

Color temperature refers to the change in light color under different energies that is perceived by the naked eye. The change of color temperature from low to high for visible light goes from orange red → white → blue .

The projector's default color temperature is set at NATIVE and it is suitable for most situations. As color temperature rises, the picture will appear to be bluer; as it decreases, the picture will appear redder. When you choose "Native", the projector will disable the white adjustment function of the input device.

White Balance

Regardless of the change in ambient light, the human eye is equipped with an automatic adjustment mechanism that makes a white object appears white and black object black. However, since no machine has such an incredible innate feature, you may need to make certain adjustments to the projector's settings when the ambient light changes so that the picture will appear closer to the actual colors.

Offset

This refers to the control of color imbalance in the darker areas of the projected picture. It is recommended that you use an external test picture with many areas of dark and gray colors (i.e. an picture of 30IRE-window). If you notice minimal amount of red, green or blue in the gray areas, adjust the offset of the corresponding color accordingly. This function will shift the entire color spectrum for the whole picture and change its brightness.

Gain

This refers to the control of color imbalance in the brighter areas of the projected picture. It is recommended that you use an external test picture with many areas of white (i.e. an picture of 80IRE-window). If you notice minimal amount of red, green or blue in the gray areas, lower the gain of the corresponding color accordingly. This function is used to increase or decrease the range of color input for the entire picture.

Generally speaking, as gain increases, the contrast of the picture will become lower. By increasing the offset, the picture brightness will become lower.

- **Red Offset**
Press ◀▶ to adjust the offset of red in dark scales.
- **Green Offset**
Press ◀▶ to adjust the offset of green in dark scales.
- **Blue Offset**
Press ◀▶ to adjust the offset of blue in dark scales.
- **Red Gain**
Press ◀▶ to adjust the gain of red in bright scales.
- **Green Gain**
Press ◀▶ to adjust the gain of green in bright scales.
- **Blue Gain**
Press ◀▶ to adjust the gain of blue in bright scales.

OSD Menu description

Aspect

Use this function to adjust the aspect ratio of the projected picture. Use ◀▶ to adjust the ratio of picture length and width.

The projector's full picture size is 16:10 (1920×1200 dots).The following diagram illustrates the difference in various aspect ratio settings:

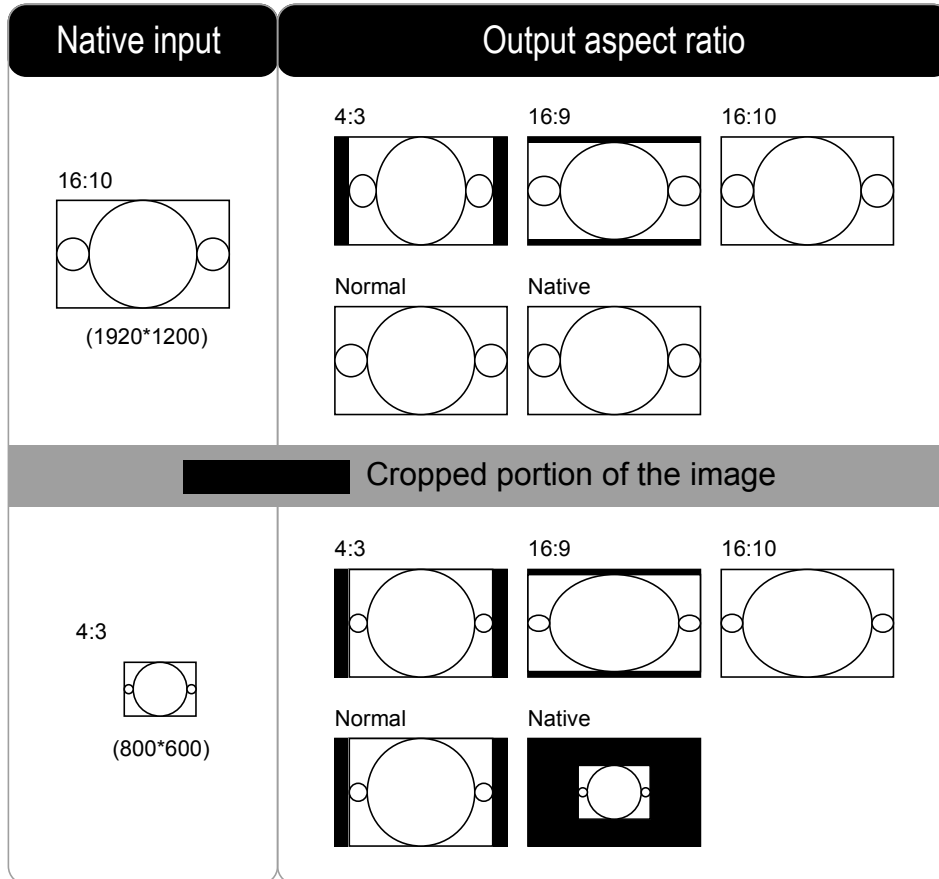

Note: When used for commercial purposes, including: projection of picture in movie theaters, hotels, cafeteria and other public venues, compression or extension of picture achieved through the change of aspect ratio may constitute copyright infringement to the rightful owner of the picture. Please do so at your own discretion.

Note: When Aspect Ratio set to Native. Function Over Scan can't adjust.

OSD Menu description

Over Scan

Due to the fact that some consumers may still be using older television systems, some TV programs may not display the edges of the picture. Use this function to hide the picture edge by choosing one of the following three options:

- **Off**
Setting it to off makes no change to the projected picture.
Note: When Over scan set to Off. Aspect Ratio can't adjust.
- **Crop**
Setting it to "Crop" will add two "masks" equivalent to 3% of horizontal resolution on either side of the picture and two similar masks above and below the projected picture.
- **Zoom**
You can use this function to enlarge the picture's horizontal resolution over the 106% of the default aspect ratio. Any portion that exceeds the original picture will be cropped.

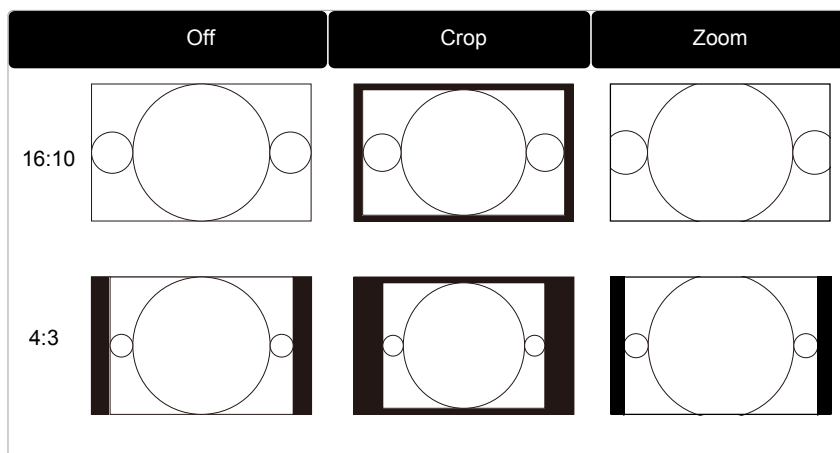

Position and Phase

• V Position

Use ◀▶ to adjust the projected picture's vertical position.

If the projected picture is not at the center of the screen (i.e. shifted up or down) and ends up being cropped, use this function to adjust the picture's vertical position. The following picture is an example of test picture from an external signal source:

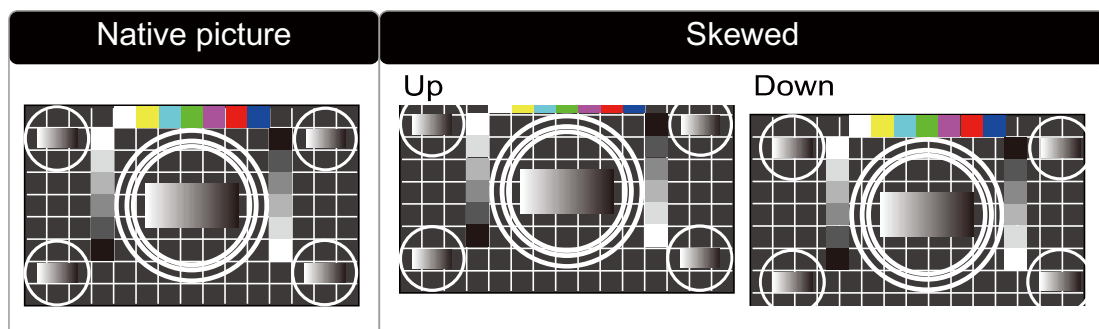

It is recommended that when adjusting the picture, the horizontal total should be adjusted before the horizontal phase. However, if the picture still flickers even after you have adjusted both, try lowering the picture noise.

OSD Menu description

• H Position

Use ◀▶ to adjust the projected picture's horizontal position.

If the projected picture is not at the center of the screen (i.e. shifted to right or left) and ends up being cropped, use this function to adjust the picture's horizontal position. The following picture is an example of test picture from an external signal source:

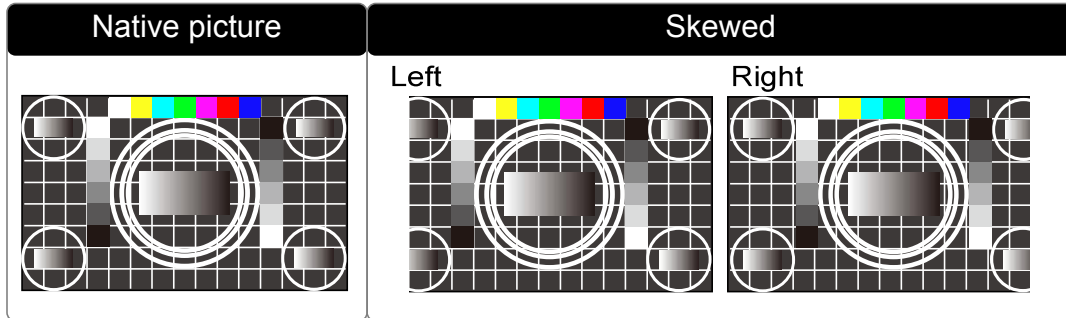

• H Phase

Use ◀▶ to adjust the projected picture's phase.

Use this function to adjust the phase of pixel sampling clock (relative to input signal).

Should the picture still flicker or show noise (i.e. edges on texts) after optimization, adjust phase accordingly.

• H Size

Press ◀▶ to adjust the horizontal total.

Use this function to adjust the clock frequency of pixel sampling (horizontal pixel frequency of the analog input source generated by the ADC). If you notice flickering or vertical lines in the picture, it means that the pixel sampling frequency is insufficient. You can use this function to adjust the frequency to achieve consistent picture quality.

The following picture is an example of test picture from an external signal source:

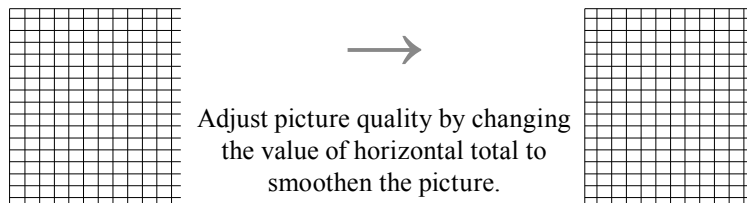

In order to adjust timings the pattern should be used is pixel (on/off)

Auto Adjust

When Auto image was selected in the OSD menu, press **ENTER** to execute the automatic picture adjustment function.

By executing this function, the projector will resync the picture. Use this function when the picture source is unstable or when you notice deterioration in picture quality and the projector will automatically adjust the picture size, phase and timing. (The adjustment also applies to PinP input source).

This function is identical to the  button on the remote control. You can simply use the hot key on the remote control to execute this function.

OSD Menu description

LASER

MAIN	Power Mode	Custom
PICTURE	Power Level	20%
LASER	High Altitude	Normal
ADVANCED		
SETUP		
SERVICE		

Power Mode

- **ECO**

When set to Eco mode, the brightness will 80% of the normal brightness(Operature temperature must lower then 35°C. The cooling fan will auto slow down the speed. If the surrounding environment is sufficiently dark or if you do not require intense brightness, you can set the power mode to Eco to save the power.

Note: ECO is automatically selected between 35~40°C(95~104°F), when the temperature is higher then 35°C. The fan speed will fully operational to exhaust the heat. This situation will not save the power.

- **Normal**

Brightness will 100%. When set to Normal mode. If the projection environment requires brighter picture, you can set the power mode to Normal for the highest projection brightness.

- **Custom**

If the picture brightness at Eco mode is too dark for you and the Normal mode gets too bright, you can set it to custom to specify the power mode to make fine adjustments to the brightness of the projected picture. you could encounter situations where the picture from projector A being brighter than projector B. When this occurs, you can use this function you could encounter situations where the picture from projector A being brighter than projector B. When this occurs, you can use this function to fine tune the brightness of the two projectors to achieve consistent picture brightness. To access this function, go to the OSD Menu → LASER→ POWER MODE→ CUSTOM and adjust accordingly.

Power Level

Press ◀ or ▶ to adjust custom power level. The function is only available when Power Mode is Custom.

High Altitude

Use this function to control the projector's cooling fan. You can set it to Off or On. The default setting is Off.

Under normal circumstances, the projector will operate normally with this function set to Off. By default, the projector will detect the temperature of the surrounding environment to regulate the speed of the cooling fan. When the ambient temperature rises, fan speed will increase (generates louder noise) to make sure the heat inside the projector gets discharged and keep the projector working normally.

However, if you were to operate the projector in environment of excessive heat or in areas of high altitude, the projector may automatically shut down. When this happens, you can enable this function by setting it to high altitude model 1 or 2 to force the cooling fan to work at a full speed to regulate the temperature inside the projector. There has 4 different model can choose as following:

- **Normal**

Suitable for 0 to 4000ft (0-1219M)

Operation temperature 0 ~35°C -> The Laser light power will 100% active.

Operation temperature 36~40°C-> The Laser light power will 80% active.

- **High 1**

Suitable for 4000ft to 5500ft (1219-1676M)

Operation temperature 0 ~30°C -> The Laser light power will 100% active.

Operation temperature 31~35°C -> The Laser light power will 90% active.

Operation temperature 36~40°C -> The Laser light power will 80% active.

- **High 2**

Suitable for 5500ft to 10000ft (1676-3048M)

Operation temperature 0 ~25°C -> The Laser light power will 100% active.

Operation temperature 26~30°C -> The Laser light power will 90% active.

Operation temperature 31~35°C -> The Laser light power will 80% active.

Operation temperature 36~40°C -> The Laser light power will 70% active.

- **Auto**

The projector will automatically sensing the surrounding and will automatic switching the High Altitude mode.

Note: Due to the air thinning substantially at high altitudes, the result of cooling achieved by the cooling fan is significantly reduced compared to operation on level ground. With low atmospheric pressure and high operating temperature, the cooling fan will not be able to disperse the heat adequately

OSD Menu description

ADVANCED

MAIN	Installation	Front Tabletop
PICTURE	Lens Control	ENTER
LASER	Lens Memory	ENTER
ADVANCED	Lens Centering	ENTER
SETUP	Gamma	2.2
SERVICE	Pattern	ENTER
	Color Management	ENTER
	Warping Blanking	ENTER
	Edge Blending	ENTER
	Memory Dynamic	ENTER
	Black	ENTER
		Off

Installation

Use these function to install the projection mode. Has below 4 mode can select:

- **Front Tabletop**
Refer to " Page 25 : Front Tabletop " for detail information.
- **Font Ceiling**
Refer to " Page 26 : Front Ceiling " for detail information.
- **Rear Tabletop**
Refer to " Page 26 : Rear Tabletop " for detail information.
- **Rear Ceiling**
Rear to " Page 26 : Rear Ceiling " for detail information.

Lens Control

- **Zoom**
This function is identical to the one covered in previous sections. Refer to " Page 23 : 7. Adjusting the projector's angle, Lens Shift, Zoom and Focus ".
 - **Focus**
This function is identical to the one covered in previous sections. Refer to " Page 23 : 7. Adjusting the projector's angle, Lens Shift, Zoom and Focus ".
 - **Shift**
This function is identical to the one covered in previous sections. Refer to " Page 23 : 7. Adjusting the projector's angle, Lens Shift, Zoom and Focus ".
- Note: The lens control is related with lens centering. Refer to " Page 51 : Lens Centering " for more information.*

OSD Menu description

Lens Memory

This projector can save 10 sets of lens position information (including Focus, Zoom and Lens shift setting). No matter how you adjust the lens, you can call these lens memory to restore the lens position setting that you record in the OSD.

- **Load Memory**
Select this item to load the your own setting for lens.
- **Save Setting**
You can adjust the OSD's color items by yourself then use this function to save your setting for lens.
- **Clear Memory**
Clear setting lens memory data.

Lens Centering

After series of lens shift operations, this function can be used to return the lens to the center position. This function need about 2 minutes. During the lens centering adjustment period. If you ask the projector to execute other instructions and cause the lens centering adjustment interrupt, or such as suddenly power failure...etc. Next time when you open on the projector or execute lens control function. The projector will pop on a warning message to ask execute Lens Centering again to force the lens to center. Then you can operate the lens other adjustment. If you execute Lens Centering. Suggest you not to Interrupt the execution of this action.

Gamma

Using different color gamut will create different color presentation in the projected picture. Generally speaking, when the surrounding are darker, it is recommended that Gamma be set higher to yield better picture quality in darker regions by sacrificing details in brighter areas. In contrast, when projecting brighter pictures, you can set the Gamma lower to give up details in the darker areas to make the brighter areas more visible.

You can choose from the following color gamma: 1.0 / 1.8 / 2.0 / 2.2 / 2.35 / 2.5 / DICOM SIM.

Pattern

The projector comes with some standard built-in patterns for testers to calibrate the equipment. These include: White / Black / Red / Green / Blue / Checkerboard / CrossHatch / V Burst / H Burst / ColorBar.

Color Management

Correct the color for all signals via adjusts the Hue/Saturation/Gain value of the Red, Green, Blue, Cyan, Magenta, Yellow and White.

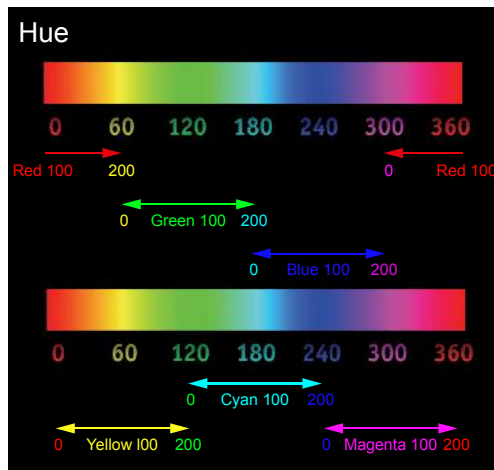

OSD Menu description

Warping

The function provides distortion correction on projected pictures.

- **Keystone**

Press ▲▼◀▶ to correct horizontal keystone due to projection angle.

Please refer to " Page 23 : 8. Correcting keystone caused by projection angle "

- **Rotation**

Press ◀▶ to correct incorrect picture angle. Refer to Fig 9.

- **Pincushion / Barrel**

Press ▲▼◀▶ to correct pincushion/barrel distortion. Refer to Fig 10.

Original picture



After Adjust
←

Fig 9

Press ◀ to adjust



Press ▶ to adjust



Fig 10

Press ◀▶ to correct pincushion distortion



Press ◀▶ to correct barrel distortion



Fig 11

Press ◀▶ to correct top left corner picture bias



Press ◀▶ to correct top left corner picture bias



Press ◀▶ to correct bottom left corner picture bias



Press ◀▶ to correct bottom right corner picture bias



- **Top Left Corner**

Press ◀▶ to correct top left corner picture bias. Refer to Fig 11

- **Top Right Corner**

Press ◀▶ to correct the right corner picture bias. Refer to Fig 11.

OSD Menu description

- **Bottom Left Corner**
Press ◀▶ to correct the bottom left picture bias. Refer to Fig 11.
- **Bottom Right Corner**
Press ◀▶ to correct the bottom left picture bias. Refer to Fig 11.

Blanking

- **TOP**
Press ▼▲ on the remote control to adjust the top blanking area on the projected picture.
- **Bottom**
Press ▼▲ on the remote control to adjust the bottom blanking area on the projected picture.
- **Left**
Press ◀▶ on the remote control to adjust the left blanking area on the projected picture.
- **Right**
Press ◀▶ on the remote control to adjust the right blanking area on the projected picture.
- **Reset**
It will reset all the blanking functions to the default settings that is without any blanking functions enabled.

Use Right and Top blanking function to block the additional picture on the screen.



Edge blending

- **Status**
Press ENTER to select ON or OFF. The function must be set to ON in order to enable the function of Edge blending. If the function is set to OFF, the function of Edge blending is disabled.
- **Blending Region** → Blending Region is to be used to set the overlapped area at the four sides for blending in multi-projection application. Adjusted lines, when enabled, will be shown for indicating the overlapped area boundary. Press ▲▼◀▶ to adjust the Blending Region at Top, Bottom, Left, Right directions on the projected picture.

Note: As shown in the below drawing, the Blending Region area is the overlap area of the projected picture 1 and the projected picture 2. The Blending Region lines that is set where the other projector last pixels ends.

OSD Menu description

- **Blending Level**→ The outward boundaries of overlapping edges might appear brighter than the rest of the image due to the lumens at the inactive DMD display area. The purpose of Blending Level is compensate the non overlap area vs the overlap area. It increases the Blending Level of non overlap area .It is used to adjust the Blending Level at Top, Bottom, Left, Right directions on the projected pictures.

After selecting and configuring the Blending Level adjustment area, each of the primary colors Red, Green, Blue can be adjusted to increase to a higher Blending Level independently, or optionally All colors together can be adjusted to increase to a higher Blending Level simultaneously.

Note: The function combination of Blending Level adjustment and 4 Corners is not available

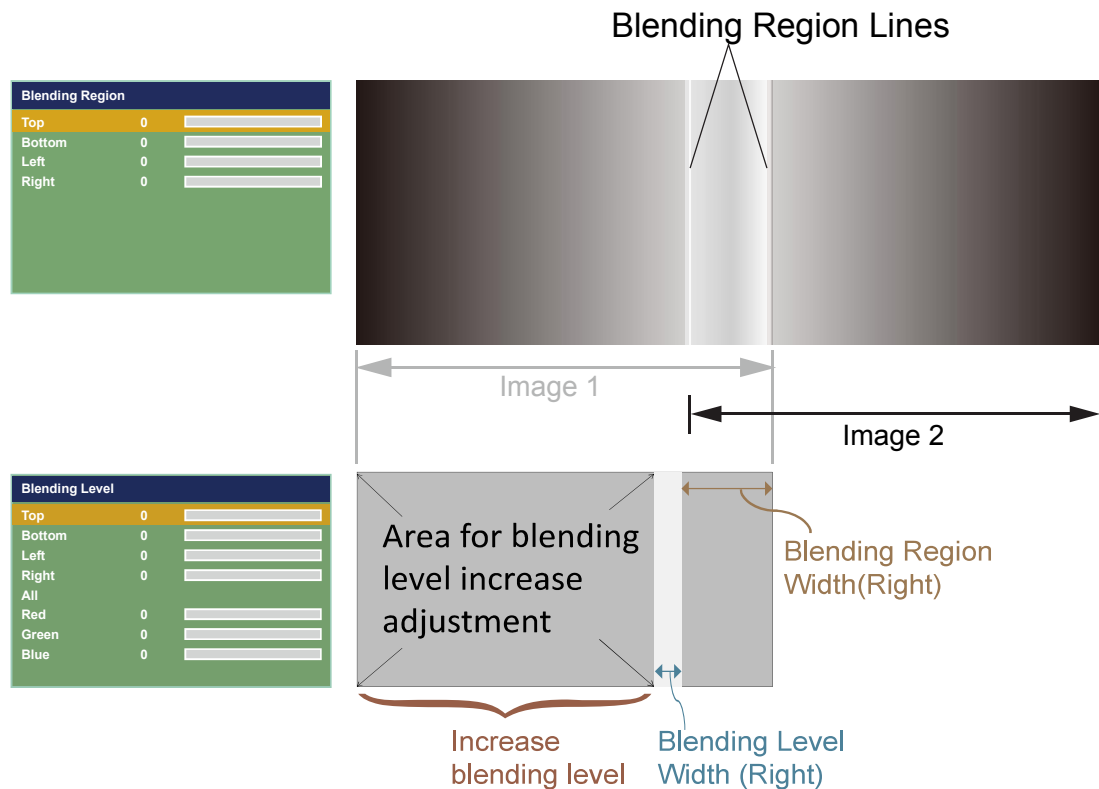

A black image is required to connect to the multiple projectors to be blended for the Blending Level adjustment. For projector projecting Image 1, Set the adjustment line of the Blending Level to the position where the inactive DMD's of another projector ends, for example: Adjust Blending Level of projector corresponding to Image 1 to match the Blending Level of inactive DMD display area of another projector. And performing the same adjustment on the projector corresponding to Image 2.

- **Reset**
The function can reset the Edge blending settings on the projector. It will restore to the pictures to the default that is without any Edge blending functions enabled.
- **Adjust Lines**
When the function is ON, there will be adjust lines on the picture in order to easily adjust multiple pictures. Press ▼▲◀▶ on the remote control to adjust the position of the lines on the picture.

OSD Menu description

The picture below is an example if 2 projectors are projecting at the same picture.

1. Horizontally place two projectors and have the two projected pictures with an overlap area and use the focus/zoom and lens shift functions with test grid pattern to set a proper overlap area for blending with a matched grid size.

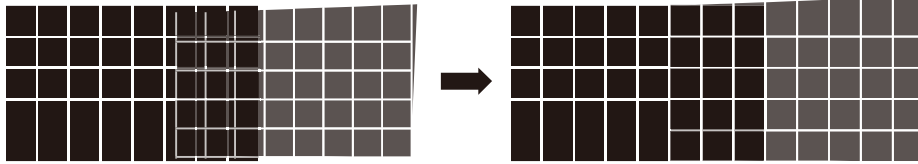

2. Color matching 2 projectors on white is done with Custom Color Space at ALIGNMENT menu.
3. Brightness matching 2 projectors can be done with the lamp power (Refer to adjustment by dimming the projector with higher lumens).
4. Use Edge blending-> Blending Region to set the blending size based on the overlap region size.
Use Edge blending-> Blending Level position to adjust the start position of Blending Level compensation.
Use Edge blending-> Blending Level to raise the brightness of non-overlap zone such that the brightness of the overlap zone and non-overlap zone are matched for Blending Level.



Note1: Please note that the following allowable warping, blanking and Edge blending combination based on the underlying chip specification

Note2: Edge blending / corner geometric correction combination is available when Blending Level is not adjusted.

Note3: Blending along corners is available when Blending Level is not adjusted.

Note: The function combination of Blending Level adjustment and blending along corners is not available.

Memory

• Load Memory

Select this item to load your own setting for projector.

• Save Setting

You can adjust the OSD's items by yourself then use this function to save your setting for projection.

Dynamic Black

Use this function to configure the projector to automatically adjust picture contrast from the source upon start up or shut down. When activated, the projector will dynamically adjust the picture contrast from the beginning of the projection until the content has ended.

Available while black image signal inputting.

This function might not work correctly, in the case of Analog signal with noise.

OSD Menu description

The picture below is an example if 2 projectors are projecting at the same picture.

1. Horizontally place two projectors and have the two projected pictures with an overlap area and use the focus/zoom and lens shift functions with test grid pattern to set a proper overlap area for blending with a matched grid size.

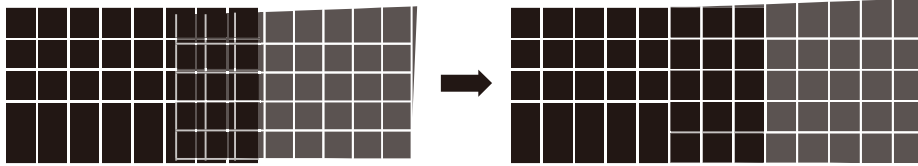

2. Color matching 2 projectors on white is done with Custom Color Space at ALIGNMENT menu.
3. Brightness matching 2 projectors can be done with the lamp power (Refer to adjustment by dimming the projector with higher lumens).
4. Use Edge blending-> Blending Region to set the blending size based on the overlap region size.
Use Edge blending-> Blending Level position to adjust the start position of Blending Level compensation.
Use Edge blending-> Blending Level to raise the brightness of non-overlap zone such that the brightness of the overlap zone and non-overlap zone are matched for Blending Level.



Note1: Please note that the following allowable warping, blanking and Edge blending combination based on the underlying chip specification

Note2: Edge blending / corner geometric correction combination is available when Blending Level is not adjusted.

Note3: Blending along corners is available when Blending Level is not adjusted.

Note: The function combination of Blending Level adjustment and blending along corners is not available.

Memory

• Load Memory

Select this item to load your own setting for projector.

• Save Setting

You can adjust the OSD's items by yourself then use this function to save your setting for projection.

Dynamic Black

Use this function to configure the projector to automatically adjust picture contrast from the source upon start up or shut down. When activated, the projector will dynamically adjust the picture contrast from the beginning of the projection until the content has ended.

Available while black image signal inputting.

This function might not work correctly, in the case of Analog signal with noise.

OSD Menu description

SETUP

MAIN	Network	ENTER
PICTURE	OSD Settings	ENTER
LASER	Infrared Remote	On
ADVANCED	Remote ID	0
SETUP	Startup Logo	On
SERVICE	Trigger	Screen
	Auto Search	Off
	Auto Power Off	Off
	Direct Power On	OFF
	Language	English
	AMX D.D.	Off

Network

- **Network Mode**

Projector Control : Choice this function to control the projector via the web.

Service : This function only for the professional service person. For download command use.

- **Standby Power**

Off : Set off, Power consumption 0.5W. Can't operate the projector via the web when projector is in standby mode.

On: Set on, Even if the projector is in standby mode, you can control the projector via the web.

Power consumption is more than "Off".

- **DHCP**

If the projector installation environment has the Dynamic Host Configuration Protocol server. You can set this function "ON" to let the projector get the auto ID from server. If no DHCP, even you set "ON" for this function. You still need to input the projector ID by yourself.

- **IP Address**

If has DHCP server and the function is on. The IP address will auto display here , or you need to enter IP by yourself.

- **Subnet Mask**

If has DHCP server and the function is on. The Subnet Mask address will auto display here , or you need to enter it value by yourself.

- **Gateway**

If has DHCP server and the function is on. The Gateway address will auto display here , or you need to enter it value by yourself.

- **DNS**

If has DHCP server and the function is on. The DNS address will auto display here , or you need to enter it value by yourself.

- **MAC Address** : Read only.

OSD Menu description

OSD Setting

- **Menu Position**

You can use this function to designate which area on the picture the OSD Menu will appear. As you can see from the diagram below, there are five positions where you can choose to have the OSD Menu displayed. The default setting is "Center".

- **Time Out**

Choice one value to display OSD on the screen time.

- **Message Box**

Machine will auto display the input signal message on screen if you select on. If you don't want to disable the message, please select off.

Infrared Remote

If you want to control the projector by Web, LAN or RS232. Suggest you set this function "Off" to prohibit control the projector via the infrared remote control.

Remote ID

Use ▲▼ to set the remote ID, after input correct ID. Press "Enter" to record the value. You can set the remote ID by remote control directly - refer to " Page 33 : Remote control " -ID Set. for detail message.

Note: This feature is disabled if the device is setting 00 to be the initial value.

Start up logo

You can use this function to have the projector display the HITACHI logo in the start up screen. Set **On** to display the HITACHI logo during start up and **Off** to display a blank picture.

If you hope to disappear the logo while no input detect, you had better change setting as page 40 "No Signal".



Trigger

The projector has one Trigger output. You can configure one devices connected to the projector via the trigger ports to be automatically turned on when the projector is on. There will be a 2-3 second delay prior to activation to prevent operation of this function when the user is choosing the desired aspect ratio.

- **Screen** Outputs 12V of power on Trigger when the user open the projector screen.
- **4:3** Outputs 12V of power on Trigger when the user chooses the 4:3 aspect ratio.
- **16:10** Outputs 12V of power on Trigger when the user chooses the 16:10 aspect ratio.
- **16:9** Outputs 12V of power on Trigger when the user chooses the 16:9 aspect ratio.

OSD Menu description

Auto Search

- **ON**

By enabling this function, the projector will automatically determine the source of input every time it is turned on so that the user will not have to make the selection on the OSD Menu.

- **OFF**

Setting the function off will require the user to specify source of picture input on the OSD Menu in order for the projector to display the intended picture.

Auto Power Off

The default value is OFF. If you set it to ON, the projector will automatically shut down after 20 minutes without any input signal.

Direct Power On

The default value is Off. If you set it to ON, the projector will automatically start up when it is connected to AC power. If you plug the projector's power cord into an AC socket with a AC switch on, you can use this function to start up the projector using the socket's switch instead of the remote. If you do not need this function, please set it to Off.

Note: When the standby power set off. Even direct AC off, the LED Light still keep lighting until 25seconds. During this period, the machine maybe can't power on normally.

Language

You can use this function to select the language you wish for the OSD Menu to be displayed in. You can choose from the following nine languages:

English, French, Spanish, German, Chinese Simplified , Japanese, Korean, Portuguese and Chinese Traditional .

AMX D.D.

Support AMX device discovery.

Connect to <http://www.amx.com/> get more information of this projector.

Web control/ Crestron Control

You can use "Web Control" function including "Crestron Control" on this projector.

To access the projector via the network from your PC, input projector's IP address to browser URL after network setting.(Refer page 56)

For example: <http://192.168.0.100/>

Then you can access "Web Control" page.

"Crestron Control" is available by selecting its sheet.

Further information about Crestron, refer to <http://www.crestron.com>



PS: IP address is the one of your projector. For example: <http://192.168.0.100/Crestron/PJeControl.html>etc.

Recommended web browser : Internet Explorer® 10/11.

Web browsers other than recommend ones may not work.

OSD Menu description

SERVICE

MAIN	Model Name	LP-WU9750B
PICTURE	Serial Number	W529ZARCY0025
LASER	Software Version 1	ME14v1-NA-FE09
ADVANCED	Software Version 2	LE07-14-RE02v1-3092
SETUP	Active Source	DVI-D
SERVICE	Signal Format	ENTER
	Laser Hours	00000 HRS
	Thermal Status	ENTER
	Factory Reset	Lens Information ENTER

The functions covered in this unit relate to the display of some basic information about the projector.

Memory of the custom timing files will be erased in the Factory Reset operation.

Model Name

the designated model number of the projector.

Serial Number

The designated serial number of the projector.

Software Version 1 / 2

The version of software installed on the projector.

Active Source

Displays the current input sources.

Signal Format

Displays the format of the current input signal.

- Timing: displays the Timing of the current input signal.
- H Freq: displays the horizontal Frequency refresh rates for the current picture.
- V Freq: displays the vertical Frequency refresh rates for the current picture.
- Pixel Clock: displays the pixel clock of the current input signal.

OSD Menu description

Laser Hours

displays Laser module current usage time.

When you notice the projected picture to be noticeably darker, please contact your local dealer.

Thermal Status

Display the thermal sensor current temperature, include Intake , DMD and Laser.

Lens Information

Lens Information Displays the lens ID and Lens name.

Factory Reset

Use this function to restore the configurations in the OSD Menu back to factory default. Note that this function will not apply to items including no signal, network, Projector control, startup Logo, language, High Altitude mode and lamp hours.

When Factory Reset is executed, all source memories created by the projector (i.e. timings files) will be erased.

Cleaning

Turn off the projector and unplug the power before cleaning. Suggest to wait at least 45 minute to let the projector cool down.

Cleaning the Cabinet

- Use a dry soft cloth to wipe off the cabinet dust.
Note: Not suggest to use cleanser. If too dirty, only use little neutral detergent to clean the cabinet.
- Use a vacuum cleaner to clean the cabinet.
Note: Poor ventilation → Cause overheat, reducing the life of the laser module. So periodically clean the machine can extended machine service life.
Note: Need to clean the interior of machine, please contact your dealer

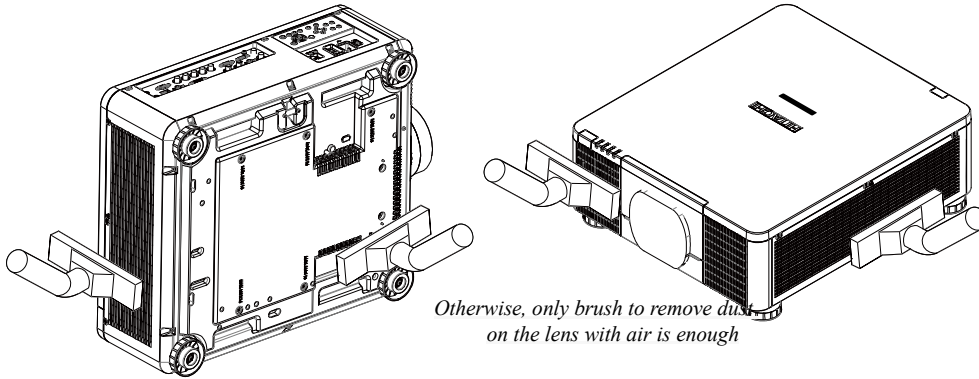

Cleaning the Lens

- Cleaning tool should include soft fur air brush, lens cleaning paper, lens cleaning fluid, soft cloth.
You can buy these items from the Camera stores.
- Use soft fur air brush to blow off dust on the lens surface. Then Gently brush the surface dust.
Note that the action should be gentle
- Fold the lens cleaning paper and add few drops of cleaning liquid on paper, follow the clockwise or counterclockwise direction to wipe lightly from Center to outside.
Cleaning liquid can't be added directly to the lens surface.
To avoid scratch the lens, do not wipe straightly back and forth.
- After the lens cleaning fluid a little dry. Get a new clean cleaning paper and using the same method to clean the lens.
- Finally, wipe the lens with a soft cloth.
Note: Not every time need to use the above method to clean the lens. Unless lenses has difficult remove soiled place.
Otherwise, only use soft fur air brush to remove dust on the lens is enough.

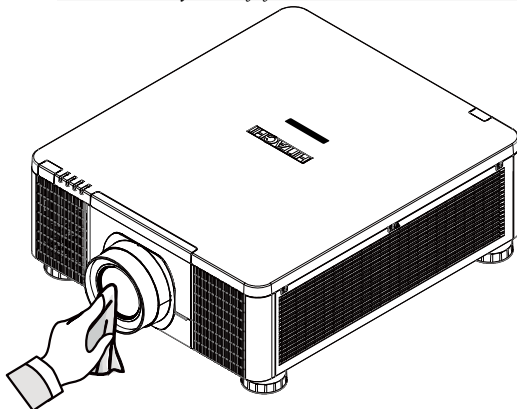

Kensington

Using the Kensington[®] Lock

Worry about the security of the projector. You can use Kensington lock the projector to avoid the it be stolen.

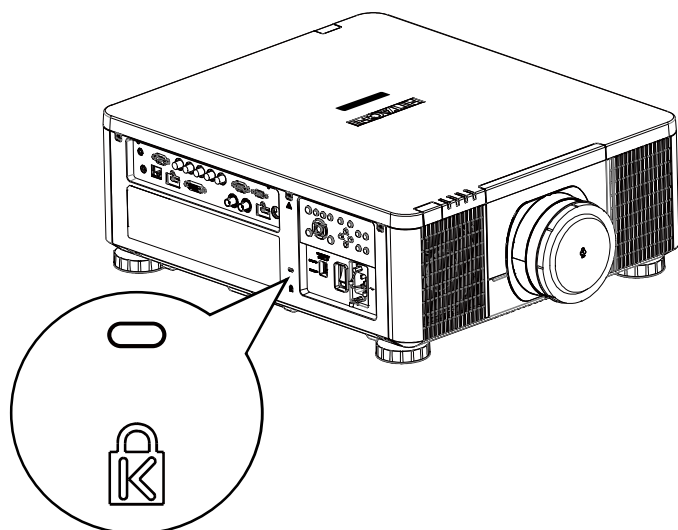

Note: For Kensington lock detail installation information. Please contact to the dealer.

Simple troubleshooting and definition of the LED indicators

Simple troubleshooting

The following table offers a list of common problems with projectors and how to troubleshoot. If the recommended solutions fail to resolve your problem, contact your local dealer to arrange for servicing; do not attempt to service the projector by yourself.

Problem	Possible cause	Solution
You cannot turn on the projector	<ol style="list-style-type: none"> 1. The projector may be unplugged 2. Check the AC POWER SWITCH on the back of the projector and see if it is flipped to Off (0). 3. The AC socket may be faulty 4. The lens is not attached. 	<ol style="list-style-type: none"> 1. Plug the projector's power cord into a wall outlet 2. Flip the power switch to "ON (1)". 3. Make sure the AC socket is working properly. 4. Mount the lens.
The remote control does not operate normally	<ol style="list-style-type: none"> 1. The battery might have run out 2. You might have inserted the batteries in the wrong orientations 3. You may be operating the remote control too far away from the projector's IR sensor or exceeded the maximum angle of signal reception ; there might be an obstacle between the projector and the remote control. Possibility interference of fluorescent light or direct sunlight. 4. Ø 3.5mm A wired remote connector might be connected to the projector's 3.5mm port. 5. The remote control's address is not consistent with the projector's address 6. Remote control is disabled by OSD menu . 	<ol style="list-style-type: none"> 1. Replace new batteries 2. Make sure the batteries are inserted in the right orientation. 3. Adjust the distance/angle between the projector and the remote control and try again; if there are obstacles between the projector and the remote or source of intense light near the IR sensor resolve these situations and try again. 4. Remove the wired remote cable or operate the projector using wired remote. 5. Refer to " Page 57 : Remote ID " for detail information. 6. Change "Infrared Remoto" setting on OSD menu.
You are able to turn on the projector and access the OSD Menu but no picture appears. "Blanc function maybe available"	<ol style="list-style-type: none"> 1. The projector may not be turned on properly or you have not selected the correct input source. 2. You might not have connected the source device correctly or the source might not be connected to the projector at all. 	<ol style="list-style-type: none"> 1. Make sure the projector is turned on properly and select the correct input source. 2. Check the connection between the projector and the input device.
You can turn on the projector. But projector display nothing on screen.	No image on screen. Only the sound of the machine operation.	Press "BLANK" of the remote control.
You have connected the projector to a DVD player as the input source but the picture appears broken or PbyP in halves.	The DVD player is connected to the projector through component cables and you have set it to progressive scan.	Disable the progress scanning function on the DVD player.
The picture looks dim	<ol style="list-style-type: none"> 1. The picture brightness, contrast, color and tint might need proper adjustment. 2. The laser setting lower power mode 	<ol style="list-style-type: none"> 1. Adjust the picture brightness, contrast, color and tint. 2. Refer to " Page 48 : Power Mode " to adjust the power mode.
The picture is too bright or the bright areas are blurry	The contrast might have been set too high.	Lower contrast settings.
The picture appears washed out or the dark areas appear too bright	The picture brightness might have been set too high.	Lower brightness settings.
The picture is blurry	<ol style="list-style-type: none"> 1. The lens may not be in focus. 2. The temperature or humidity of the projector's working environment may have changed in mid operation (i.e. going from cold to warm or dry to humid), leading to condensation of moisture inside the projector. 	<ol style="list-style-type: none"> 1. Adjust Lines focus. 2. Turn of the projector first and wait for the moisture in the projector to evaporate.
The color of the picture looks pale	<ol style="list-style-type: none"> 1. The input signal type might not have been connected properly 2. The Color is not correct setting. 	<ol style="list-style-type: none"> 1. Check to make sure that the connections between the projector and the input device are correct. 2. Press Menu to adjust the color related setting.
The picture flashes occasionally	1. The cables might not have been properly connected or the input device itself may be faulty.	1. Make sure the connector and the input device have been properly connected; check to see if the input device is in normal working order.
The colors of the projected picture are out of place (i.e. displaying red as blue)	The G/Y, R/Pr, B/Pb cables from the input might have been incorrectly connected to the input.	Please make sure the input source has been correctly connected to the projector.

Simple troubleshooting and definition of the LED indicators

Problem	Possible cause	Solution
The noise from the cooling fan suddenly grew louder	<ol style="list-style-type: none"> 1. The temperature inside the projector might have risen. 2. The OSD Menu set the Higt Altitude Mode 	<ol style="list-style-type: none"> 1. When the temperature inside the projector rises, the cooling fan will operate at a higher speed to discharge the internal heat more rapidly. 2. Set the High Altitude mode to Off or Auto if the projector is under 4000ft. Refer to " Page 49 : High Altitude "
The LED indicator on the projector's top panel is blinking in red	The cooling fan, power....etc. could be faulty.	Refer to the definition of " Page 65 : LED STATUS "
<ol style="list-style-type: none"> 1. During projection, the light suddenly goes off and the picture disappears. 2.The lights does not turn on even when the projector has been turned on. 	The light module might have been damaged; check the LED indicator on the rear panel of the projector and see if it is blinking in red.	The light meodu has reached the end of its service life; please replace it.

Simple troubleshooting and definition of the LED indicators

LED STATUS

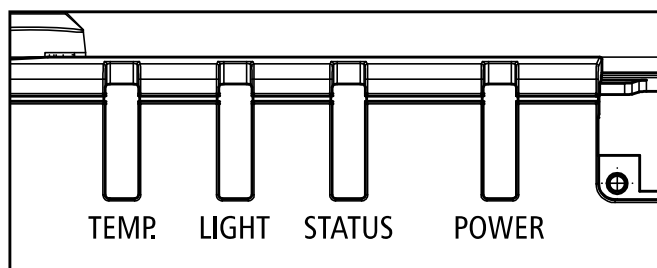

Power LED

LED Display		Projector Status	Procedure
Off		Power is off	
Flashing	Green	Prepare to turn on projector	wait till projector start displaying
	Orange	Projector cooling	wait until cooling finish (~ 10 sec)
On	Red	Standby mode	
	Green	Projectpr is on	

Status LED

LED Display		Projector Status	Procedure
Off		No Problem	
Flashing	Red (Cycles of 1)	Prepare to turn on projector	Use "op prerr" to see detail
	Red (Cycles of 4)	Projector cooling	Use "op prerr" to see detail
On	Red	Standby mode	Use "op prerr" to see detail

Light LED

LED Display		Projector Status	Procedure
Off		Laser is off	
Flashing	Green	Prepare to light laser	
	Red (Cycles of 6)	laser lit fail	
On	Red	Laser is end-of-life	
	Green	Laser is on	

Temp. LED

LED Display		Projector Status	Procedure
Off		No Problem	
Flashing	Red	Temperature problem	Use "op prerr" to see detail

Remark:

The time period of each step in the above LED blinking pattern is 500 milliseconds, e.g., for “Cooling / Warm up” state, the green LED will ON for 500 milliseconds, and then OFF 500 milliseconds, and then repeat the above LED pattern.

Projector specifications

Specifications

Description	Specifications
Resolution	1920 × 1200 (Native)
Micro display	1 x 0.67" WUXGA DMD
Contrast	1050:1(Native) / 10000:1 (Dynamic Black On)
Luminance uniformity	≥ 90%
Lamp	Laser Diode: Green and Red by laser phosphor Blue by diffuse laser
Projection lens - projection ratio	FL-920 (0.32 : 1 100-350inch) ML-904 (2.38~3.64 : 1 50-600inch) USL-901 (0.76~0.95 : 1 50-600inch) LL-905 (3.47~5.63 : 1 50-600inch) SL-902 (1.14~1.72 : 1 50-600inch) UL-906 (5.53~8.79 : 1 50-600inch) SD-903 (1.61~2.44 : 1 50-600inch)
Input/Output ports	1 x 3.5mm Mini Jack for 12V Trigger 1 x Computer In (5BNC RGBHV/YPbPr/YCbCr) 1 x Computer In (D-SUB) 1 x RS-232 1 x Wire Remote 1 x HDBaseT/LAN 2 x HDMI 1 x DVI -D 1 x SDI(IN/OUT)
Primary voltage range	100V - 130V (±10%) / 200V - 240V (±10%)
Standby power consumption	0.5W max power when Standby Power setting is disabled
Maximum input resolution	1920 × 1200
Operating temperature	0~40°C Note 1: The normal operating temperature of the DMD is between 10~65°C Note 2: The DMD may operate normally for approximately 10 minutes under 0~10°C short operation under such temperature will not result in DMD damage.
Weight	28 kg (Without PJ Lens, PD units)
Optional parts	Lens FL-900 (Reflective throw lens) FL-920 support metal FL-920 (Reflective throw lens and support metal) USL-901 (Short throw lens) SL-902 (Short throw lens) SD-903 (Standard lens) ML-904 (Middle throw lens) LL-905 (Long throw lens) UL-906 (Ultra long throw lens) Ceiling mount equipment HAS-304H (Long ceiling mount) HAS-204L (Standard ceiling mount) HAS-104S (Short ceiling mount) HAS-404U (Ceiling mount with 6-axis adjustment) HAS-L9750 (Attachment bracket)

Projector specifications

Supported Signal Input Modes

Signal Format	Resolution	H Freq. KHz	Frame Rate Hz	PCLK MHz	5 BNC	VGA RGBHV	5 BNC RGBHV	DVI-D	HDMI / HDBaseT			HD/SDI/3G	Remark
									RGB	YUV			
										8bit	10bit		
PC	640*480	31.469	59.94	25.175		X	X	X	X				VESA DMT
	640*480	37.500	74.99	31.500		X	X	X	X				VESA DMT
	640*480	43.269	85	36.000		X	X	X	X				VESA DMT
	800*600	37.879	60.32	40.000		X	X	X	X				VESA DMT
	800*600	46.875	75	49.500		X	X	X	X				VESA DMT
	800*600	53.674	85.06	56.250		X	X	X	X				VESA DMT
	848*480	23.674	47.95	25.000		X	X	X	X				VESA CVT
	848*480	31.020	60	33.750		X	X	X	X				VESA DMT
	1024*768	48.363	60	65.000		X	X	X	X				VESA DMT
	1024*768	60.023	75	78.750		X	X	X	X				VESA DMT
	1024*768	68.677	85	94.500		X	X	X	X				VESA DMT
	1280*720	35.531	47.95	57.987		X	X	X	X				VESA GTF
	1280*1024	63.981	60.02	108.000		X	X	X	X				VESA DMT
	1280*1024	91.146	85.02	157.500		X	X	X	X				VESA DMT
	1600*1200	75.000	60	162.000		X	X	X	X				VESA DMT
	1920*1080	53.225	47.95	135.403		X	X	X	X				VESA CVT
	1680*1050	65.290	60	146.250		X	X	X	X				VESA DMT
	1920*1200 RB	74.038	60	154.000		X	X	X	X				VESA CVT
	1400*1050	65.317	60	121.750		X	X	X	X				VESA DMT
	1366*768	47.712	60	85.500		X	X	X	X				VESA DMT
1440*900	55.935	60	106.500		X	X	X	X				VESA DMT	
1280*768	47.776	60	79.500		X	X	X	X				VESA DMT	
1280*800	49.702	60	83.500		X	X	X	X				VESA DMT	
1280*960	60.000	60	108.000		X	X	X	X				VESA DMT	
Apple MAC	640*480	35.000	66.67	30.240		X	X	X	X				Apple MAC
	832*624	49.720	74.54	57.280		X	X	X	X				Apple MAC
SDTV	480i	15.734	59.94	13.500	X							X	
	1440*480i	31.468	60	27.000					X	X	X	X	
	1440*576i	31.250	50	27.000					X	X	X	X	
	576i	15.625	50	13.500	X							X	
EDTV	480p	31.469	59.94	27.000	X	X	X	X	X	X	X	X	
	576p	31.250	50	27.000	X	X	X	X	X	X	X	X	
HDTV	1035i	33.750	60	74.250	X	X	X	X	X	X	X	X	X
	1080i	28.125	50	74.250	X	X	X	X	X	X	X	X	X
	1080i	33.716	59.94	74.176	X	X	X	X	X	X	X	X	X
	1080i	33.750	60	74.250	X	X	X	X	X	X	X	X	X
	720p	37.500	50	74.250	X	X	X	X	X	X	X	X	X
	720p	44.955	59.94	74.176	X	X	X	X	X	X	X	X	X
	720p	45.000	60	74.250	X	X	X	X	X	X	X	X	X
	1080p	26.973	23.98	74.176	X	X	X	X	X	X	X	X	X
	1080p	27.000	24	74.250	X	X	X	X	X	X	X	X	X
	1080p	28.125	25	74.250	X	X	X	X	X	X	X	X	X
	1080p	33.716	29.97	74.176	X	X	X	X	X	X	X	X	X
	1080p	33.750	30	74.250	X	X	X	X	X	X	X	X	X
	1080p	56.250	50	148.500	X	X	X	X	X	X	X	X	X
1080p	67.433	59.94	148.352	X	X	X	X	X	X	X	X	X	
1080p	67.500	60	148.500	X	X	X	X	X	X	X	X	X	
PsF formats	1080sf	33.750	30	74.250								X	
	1080sf	28.125	25	74.250								X	

Projector specifications

SDI formats

Timing	SDI Link mode	Signal Standards	Color Encode	Sampling Structure	Bit Depth
NTSC	SD	SMPTE 259M-C 270Mbps SD	YCbCr	4:2:2	10
PAL	SD	SMPTE 259M-C 270Mbps SD	YCbCr	4:2:2	10
1035i60	HD	SMPTE 292M 1.5Gbps HD	YCbCr	4:2:2	10
1080i59	HD	SMPTE 292M 1.5Gbps HD	YCbCr	4:2:2	10
1080i60	HD	SMPTE 292M 1.5Gbps HD	YCbCr	4:2:2	10
1080P30	HD	SMPTE 292M 1.5Gbps HD	YCbCr	4:2:2	10
1080P25	HD	SMPTE 292M 1.5Gbps HD	YCbCr	4:2:2	10
1080i50	HD	SMPTE 292M 1.5Gbps HD	YCbCr	4:2:2	10
1080P24	HD	SMPTE 292M 1.5Gbps HD	YCbCr	4:2:2	10
720P60	HD	SMPTE 292M 1.5Gbps HD	YCbCr	4:2:2	10
720P50	HD	SMPTE 292M 1.5Gbps HD	YCbCr	4:2:2	10
1080Sf25	HD	SMPTE 292M 1.5Gbps HD	YCbCr	4:2:2	10
1080Sf30	HD	SMPTE 292M 1.5Gbps HD	YCbCr	4:2:2	10
1080P50	3G Level A	SMPTE 424M 3Gbps	YCbCr	4:2:2	10
1080P59	3G Level A	SMPTE 424M 3Gbps	YCbCr	4:2:2	10
1080P60	3G Level A	SMPTE 424M 3Gbps	YCbCr	4:2:2	10
1080P50	3G Level B	SMPTE 424M 3Gbps	YCbCr	4:2:2	10
1080P59	3G Level B	SMPTE 424M 3Gbps	YCbCr	4:2:2	10
1080P60	3G Level B	SMPTE 424M 3Gbps	YCbCr	4:2:2	10

Test Cable: Belden 1694A

3D Timing Format

Standard	Resolution	V-Freq (Hz)	V-Total	H-Freq (kHz)	HDBaseT (*1)	HDMI1/2 (*1)	DVI-D (*2)	Remarks
720p50	Frame Packing	1280x720	50	1470	37.5	√	√	*3
720p59	Frame Packing	1280x720	59.94	1470	44.96	√	√	*3
720p60	Frame Packing	1280x720	60	1470	45	√	√	*3
720p50	Top-and-Bottom	1280x720	50	750	37.5	√	√	*3
720p59	Top-and-Bottom	1280x720	59.94	750	44.96	√	√	*3
720p60	Top-and-Bottom	1280x720	60	750	45	√	√	*3
1080p23	Frame Packing	1920x1080	23.98	2205	26.97	√	√	
1080p24	Frame Packing	1920x1080	24	2205	27	√	√	
1080i50	Side-by-Side (Half)	1920x1080	50	1125	56.25	√	√	*3
1080i59	Side-by-Side (Half)	1920x1080	59.94	1125	67.43	√	√	*3
1080i60	Side-by-Side (Half)	1920x1080	60	1125	67.5	√	√	*3
1080p50	Side-by-Side (Half)	1920x1080	50	1125	56.25	√	√	*3
1080p59	Side-by-Side (Half)	1920x1080	59.94	1125	67.43	√	√	*3
1080p60	Side-by-Side (Half)	1920x1080	60	1125	67.5	√	√	*3
1080p50	Top-and-Bottom	1920x1080	50	1125	56.25	√	√	*3
1080p59	Top-and-Bottom	1920x1080	59.94	1125	67.43	√	√	*3
1080p60	Top-and-Bottom	1920x1080	60	1125	67.5	√	√	*3
1080p50	Frame Sequential	1920x1080	50	1125	56.25	√	√	*3
1080p59	Frame Sequential	1920x1080	59.94	1125	67.43	√	√	*3
1080p60	Frame Sequential	1920x1080	60	1125	67.5	√	√	*3

*1: Based on IT6802 chip specification

*2: Based on IT6535 chip specification

*3: Frame drop at scaler and frame doubling at formatter

Projector specifications

Dimensions

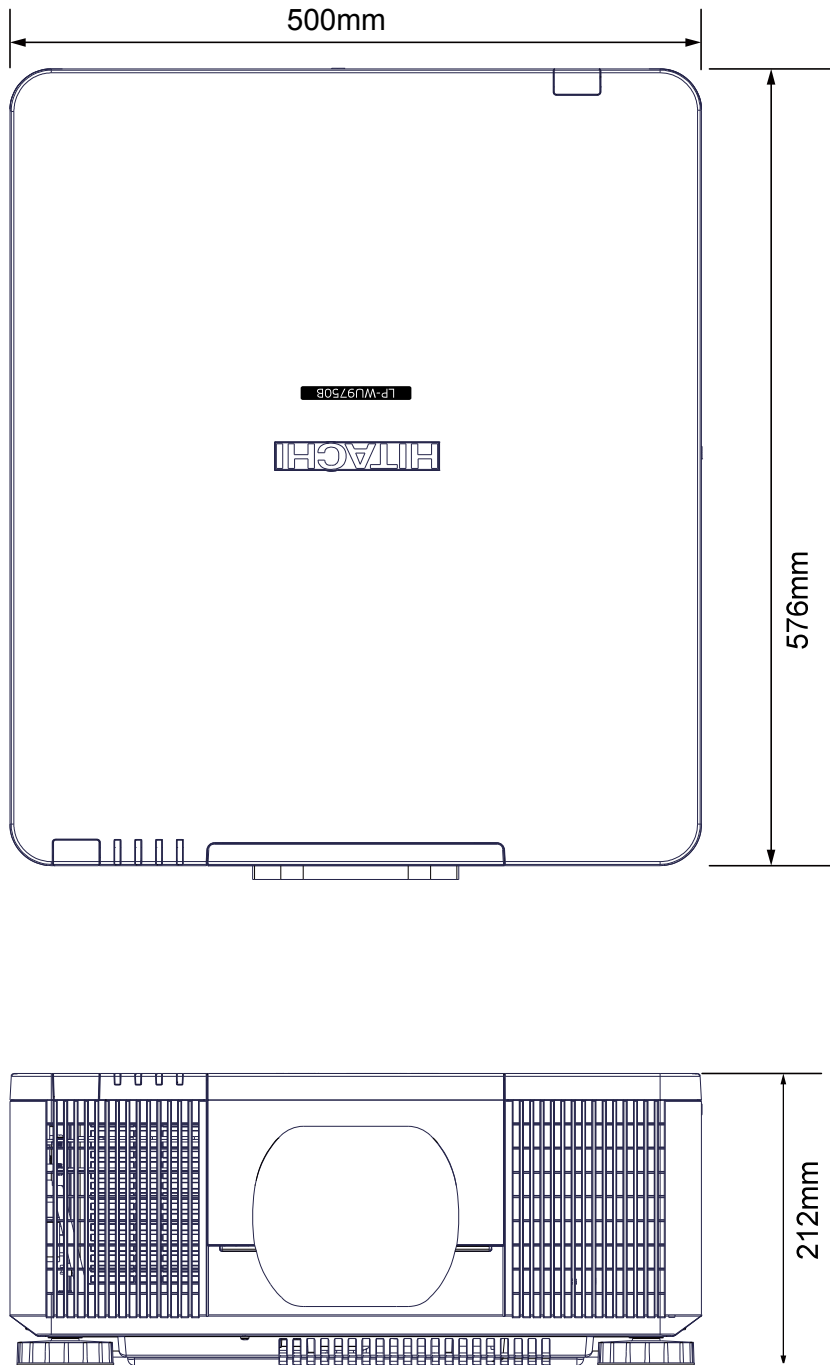

Communication settings

Communication settings

RS-232 Communication

When the projector connects to the computer by RS-232 communication, the projector can be controlled with RS-232 commands from the computer. For details of RS-232 commands, refer to RS-232 Communication command table.

Connection

1. Turn off the projector and the computer.
2. Connect the projector's RS232 port and the computer's RS-232 port with a RS-232 cable (straight) . Use the cable that fulfills the specification shown in the figure
3. Turn the computer on, and after the computer has started up turn the projector on.

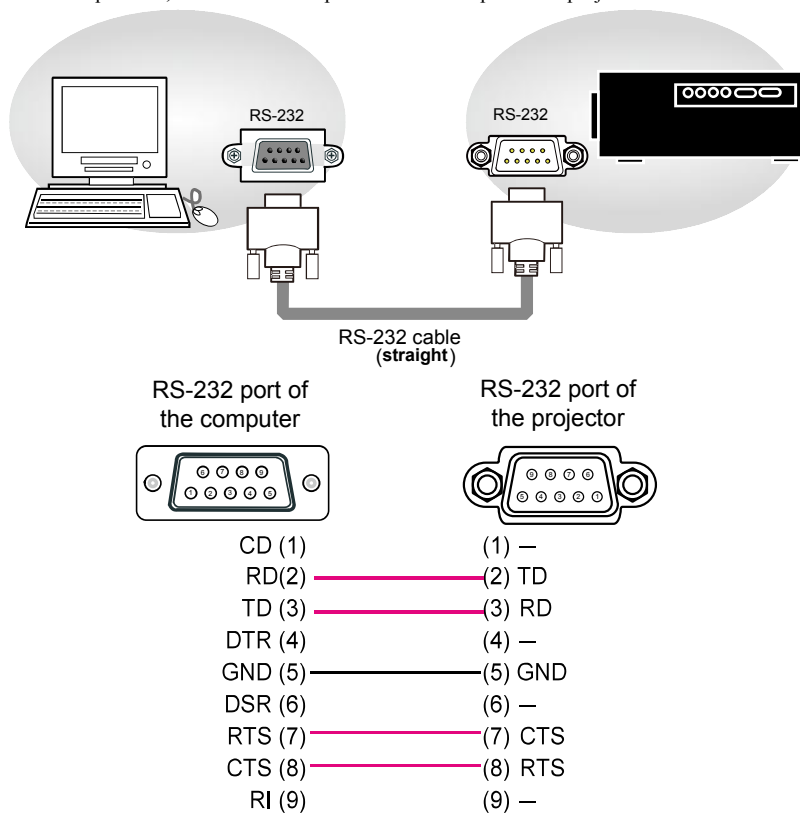

Note: In case of replacement and RS-232 cable (cross) has been installed, please add a packed RS-232 cable (cross) to make connection correctly.

Communication settings

1. Protocol

19200bps,8N1

2. Command format

("h" shows hexadecimal)

Byte Number	0	1	2	3	4	5	6	7	8	9	10	11	12
Command Action	Header						Data						
	Header code		Packet	Data size		CRC flag		Action		Type		Setting code	
	L	H		L	H	L	H	L	H	L	H	L	H
<SET>Change setting to desired value [(cL)(cH)] by [(bL)(bH)].	BEh	EFh	03h	06h	00h	(aL)	(aH)	01h	00h	(bL)	(bH)	(cL)	(cH)
<GET>Read projector internal setup value [(bL)(bH)] .						(aL)	(aH)	02h	00h	(bL)	(bH)	00h	00h
<INCREMENT> Increment setup value [(bL)(bH)] by 1.						(aL)	(aH)	04h	00h	(bL)	(bH)	00h	00h
<DECREMENT> Decrement setup value [(bL)(bH)] by 1.						(aL)	(aH)	05h	00h	(bL)	(bH)	00h	00h
<EXECUTE> Run a command [(bL)(bH)].						(aL)	(aH)	06h	00h	(bL)	(bH)	00h	00h

[Header code] [Packet] [Data size]

Set [BEh, EFh, 03h, 06h, 00h] to byte number 0~4.

[CRC flag]

For byte number 5, 6, refer to RS-232 Communication command table.

[Action]

Set functional code to byte number 7, 8.

<SET> = [01h, 00h], <GET> = [02h, 00h], <INCREMENT> = [04h, 00h]

<DECREMENT> = [05h, 00h], <EXECUTE> = [06h, 00h]

Refer to RS232 Communication command table

[Type] [Setting code]

For byte number 9~12 , , refer to RS-232 Communication command table.

Communication settings

3. Response code / Error code

("h" shows hexadecimal)

4. ACK reply : 06h
When the projector receives the Set, Increment, Decrement or Execute , command correctly, the projector changes the setting data for the specified , item by [Type], and it returns the code.
5. NAK reply : 15h
When the projector cannot understand the received command, the projector , returns the error code. In such a case, check the sending code and send the same command again.
6. Error reply : 1Ch + 0000h
When the projector cannot execute the received command for any reasons, the projector returns the error code. In such a case, check the sending code and the setting status of the projector
7. Data reply : 1Dh + xxxxh
When the projector receives the GET command correctly, the projector returns the response code and 2 bytes of data.

Note

-For connecting the projector to your devices, please read the manual for each devices, and connect them correctly with suitable cables.

-Operation cannot be guaranteed when the projector receives an undefined command or data.

-Provide an interval of at least 40ms between the response code and any other code.

-The projector outputs test data when the power supply is switched ON, and when the lamp is lit. Ignore this data.

-Commands are not accepted during warm-up.

-When the data length is greater than indicated by the data length code, the projector ignore the excess data code.

Conversely when the data length is shorter than indicated by the data length code, the projector returns the error code to the computer.

Communication settings

Command Control via the Network

When the projector connects network, the projector can be controlled with RS-232C commands from the computer with web browser.

For details of RS-232C commands, refer to RS-232C Communication / Network command table.

Connection

1. Turn off the projector and the computer.
2. If you use wired LAN, connect the projector's **HDBaseT™** port to the computer's LAN or **HDBaseT** port with a LAN cable. Use the cable that fulfills the specification shown in figure.
3. Turn the computer on, and after the computer has started up turn the projector on.

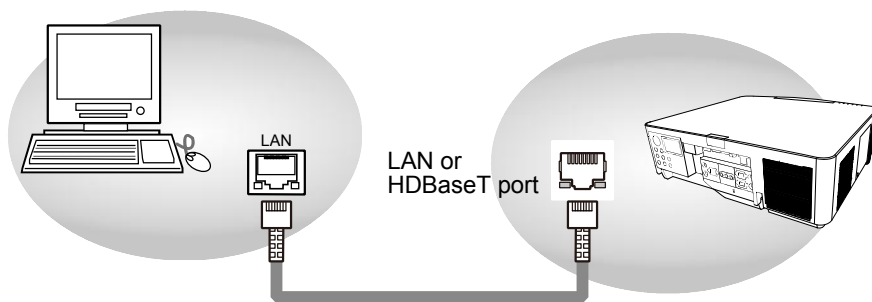

- LAN cable (CAT-5e or greater)
or
- For HDBaseT connection
 - CAT-5e or greater
 - shielded type (connectors included)
 - straight cable
 - single cable

Communication Port

The following two ports are assigned for the command control.

TCP #23

Communication settings

Command control settings

[TCP #23]

1. Command format

Same as RS-232C communication, refer to RS-232C Communication command format.

2. Response code / Error code ("h" shows hexadecimal)

Four of the response / error code used for TCP#23 are the same as RS-232C Communication (1)~(4).

(1) **ACK reply : 06h**

Refer to RS-232C communication.

(2) **NAK reply : 15h**

Refer to RS-232C communication.

(3) **Error reply : 1Ch + 0000h**

Refer to RS-232C communication.

(4) **Data reply : 1Dh + xxxh**

Refer to RS-232C communication.

NOTE • Operation cannot be guaranteed when the projector receives an undefined command or data.
• Provide an interval of at least 40ms between the response code and any other code.
• Commands are not accepted during warm-up.

Communication settings

Communication command table

	Hitachi Command									Description	
	Function	Operation	Header Data (7 bytes)				Command Data (6 bytes)				
			Header Code	Packet	Data Size	CRC	Action	Type	Setting Code		
Main	Input Source	Set	HDMI 1	BE EF	03	06 00	0E D2	01 00	00 20	03 00	
			HDMI 2	BE EF	03	06 00	6E D6	01 00	00 20	0D 00	
			Computer In 1	BE EF	03	06 00	FE D2	01 00	00 20	00 00	
			Computer In 2	BE EF	03	06 00	3E D0	01 00	00 20	04 00	
			HDBaseT	BE EF	03	06 00	AE DE	01 00	00 20	11 00	
			SDI	BE EF	03	06 00	5E DE	01 00	00 20	12 00	
		DVI-D	BE EF	03	06 00	AE D4	01 00	00 20	09 00		
		Get	BE EF	03	06 00	CD D2	02 00	00 20	00 00		
	PinP	Set	Off	BE EF	03	06 00	3E 26	01 00	10 23	00 00	
			On	BE EF	03	06 00	5E 27	01 00	10 23	02 00	
			Get	BE EF	03	06 00	0D 26	02 00	10 23	00 00	
	PinP Selection	Set	HDMI 1	BE EF	03	06 00	B6 23	01 00	02 23	03 00	
			HDMI 2	BE EF	03	06 00	D6 27	01 00	02 23	0D 00	
			Computer In 1	BE EF	03	06 00	46 23	01 00	02 23	00 00	
			Computer In 2	BE EF	03	06 00	86 21	01 00	02 23	04 00	
			HDBaseT	BE EF	03	06 00	16 2F	01 00	02 23	11 00	
			SDI	BE EF	03	06 00	E6 2F	01 00	02 23	12 00	
		DVI-D	BE EF	03	06 00	16 25	01 00	02 23	09 00		
		Get	BE EF	03	06 00	75 23	02 00	02 23	00 00		
	PinP Position	Set	Top left	BE EF	03	06 00	02 23	01 00	01 23	00 00	
			Top right	BE EF	03	06 00	92 22	01 00	01 23	01 00	
			Bottom left	BE EF	03	06 00	62 22	01 00	01 23	02 00	
			Bottom right	BE EF	03	06 00	F2 23	01 00	01 23	03 00	
		PbyP	BE EF	03	06 00	C2 2E	01 00	01 23	10 00		
		Get	BE EF	03	06 00	31 23	02 00	01 23	00 00		
	Color Space	Set	Auto	BE EF	03	06 00	02 68	01 00	71 22	00 00	
			REC709	BE EF	03	06 00	92 69	01 00	71 22	01 00	
			REC601	BE EF	03	06 00	62 69	01 00	71 22	02 00	
			RGB PC	BE EF	03	06 00	F2 68	01 00	71 22	03 00	
		RGB Video	BE EF	03	06 00	C2 6A	01 00	71 22	04 00		
		Get	BE EF	03	06 00	31 68	02 00	71 22	00 00		
	3D Format	Set	Off	BE EF	03	06 00	DA 58	01 00	8B 22	00 00	
			Auto	BE EF	03	06 00	4A 59	01 00	8B 22	01 00	
Side by Side			BE EF	03	06 00	BA 59	01 00	8B 22	02 00		
Top and Bottom			BE EF	03	06 00	2A 58	01 00	8B 22	03 00		
Frame Sequential		BE EF	03	06 00	1A 5A	01 00	8B 22	04 00			
	Get	BE EF	03	06 00	E9 58	02 00	8B 22	00 00			
3D - Eye Swap	Set	Normal	BE EF	03	06 00	AE 59	01 00	8C 22	00 00		
		Reverse	BE EF	03	06 00	3E 58	01 00	8C 22	01 00		
	Get	BE EF	03	06 00	9D 59	02 00	8C 22	00 00			
3D - DLP Link	Set	Off	BE EF	03	06 00	52 58	01 00	8D 22	00 00		
		On	BE EF	03	06 00	C2 59	01 00	8D 22	01 00		
	Get	BE EF	03	06 00	61 58	02 00	8D 22	00 00			
Magnify		Increment	BE EF	03	06 00	1A D2	04 00	07 30	00 00		
		Decrement	BE EF	03	06 00	CB D3	05 00	07 30	00 00		
		Get	BE EF	03	06 00	7C D2	02 00	07 30	00 00		
Horz Shift		Increment	BE EF	03	06 00	5B 5F	04 00	94 22	00 00		
		Decrement	BE EF	03	06 00	8A 5E	05 00	94 22	00 00		
		Get	BE EF	03	06 00	3D 5F	02 00	94 22	00 00		
Vert Shift		Increment	BE EF	03	06 00	A7 5E	04 00	95 22	00 00		
		Decrement	BE EF	03	06 00	76 5F	05 00	95 22	00 00		
		Get	BE EF	03	06 00	C1 5E	02 00	95 22	00 00		

Communication settings

Communication command table (continue)

Hitachi Command											
Function	Operation	Header Data (7 bytes)				Command Data (6 bytes)			Description		
		Header Code	Packet	Data Size	CRC	Action	Type	Setting Code			
Main	Horz Shift	Increment	BE EF	03	06 00	AED7	04 00	10 30	00 00		
		Decrement	BE EF	03	06 00	7F D6	05 00	10 30	00 00		
		Get	BE EF	03	06 00	C8 D7	02 00	10 30	00 00		
	Vert Shift	Increment	BE EF	03	06 00	52 D6	04 00	11 30	00 00		
		Decrement	BE EF	03	06 00	83 D7	05 00	11 30	00 00		
		Get	BE EF	03	06 00	34 D6	02 00	11 30	00 00		
	Magnify & Shift Reset	Execute	BE EF	03	06 00	EC D6	06 00	17 70	00 00		
	"No Signal (Start up)"	Set	Logo	BE EF	03	06 00	CB E3	01 00	04 30	40 00	
			Black	BE EF	03	06 00	AB D1	01 00	04 30	06 00	
			Blue	BE EF	03	06 00	FB D2	01 00	04 30	03 00	
			White	BE EF	03	06 00	5B D1	01 00	04 30	05 00	
Get			BE EF	03	06 00	38 D2	02 00	04 30	00 00		
Picture	Picture Mode	Set	High Bright	BE EF	03	06 00	23 CA	01 00	BA 30	50 00	
			Presentation	BE EF	03	06 00	B3 CB	01 00	BA 30	51 00	
			Video	BE EF	03	06 00	43 CB	01 00	BA 30	52 00	
		Get	BE EF	03	06 00	10 F6	02 00	BA 30	00 00		
	Brightness	Increment	BE EF	03	06 00	EF D2	04 00	03 20	00 00		
		Decrement	BE EF	03	06 00	3E D3	05 00	03 20	00 00		
		Get	BE EF	03	06 00	89 D2	02 00	03 20	00 00		
	Contrast	Increment	BE EF	03	06 00	9B D3	04 00	04 20	00 00		
		Decrement	BE EF	03	06 00	4A D2	05 00	04 20	00 00		
		Get	BE EF	03	06 00	FD D3	02 00	04 20	00 00		
	Color	Increment	BE EF	03	06 00	D3 72	04 00	02 22	00 00		
		Decrement	BE EF	03	06 00	02 73	05 00	02 22	00 00		
		Get	BE EF	03	06 00	B5 72	02 00	02 22	00 00		
	Tint	Increment	BE EF	03	06 00	2F 73	04 00	03 22	00 00		
		Decrement	BE EF	03	06 00	FE 72	05 00	03 22	00 00		
		Get	BE EF	03	06 00	49 73	02 00	03 22	00 00		
	Sharpness	Increment	BE EF	03	06 00	97 72	04 00	01 22	00 00		
		Decrement	BE EF	03	06 00	46 73	05 00	01 22	00 00		
		Get	BE EF	03	06 00	F1 72	02 00	01 22	00 00		
	Noise Reduction	Increment	BE EF	03	06 00	7F 70	04 00	0F 22	00 00		
		Decrement	BE EF	03	06 00	AE 71	05 00	0F 22	00 00		
		Get	BE EF	03	06 00	19 70	02 00	0F 22	00 00		
	Color Temperature	Set	5400K	BE EF	03	06 00	5B E2	01 00	B0 30	36 00	
			6500K	BE EF	03	06 00	AB C5	01 00	B0 30	41 00	
			7500K	BE EF	03	06 00	0B C3	01 00	B0 30	4B 00	
			9300K	BE EF	03	06 00	6B CD	01 00	B0 30	5D 00	
			Native	BE EF	03	06 00	0B B4	01 00	B0 30	FF 00	
	Get	BE EF	03	06 00	C8 F5	02 00	B0 30	00 00			
	White Balance - Red Offset	Increment	BE EF	03	06 00	62 F5	04 00	B5 30	00 00		
		Decrement	BE EF	03	06 00	B3 F4	05 00	B5 30	00 00		
		Get	BE EF	03	06 00	04 F5	02 00	B5 30	00 00		
	White Balance - Green Offset	Increment	BE EF	03	06 00	26 F5	04 00	B6 30	00 00		
		Decrement	BE EF	03	06 00	F7 F4	05 00	B6 30	00 00		
		Get	BE EF	03	06 00	40 F5	02 00	B6 30	00 00		
	White Balance - Blue Offset	Increment	BE EF	03	06 00	DA F4	04 00	B7 30	00 00		
		Decrement	BE EF	03	06 00	0B F5	05 00	B7 30	00 00		
		Get	BE EF	03	06 00	BC F4	02 00	B7 30	00 00		

Communication settings

Communication command table (continue)

Hitachi Command											
Function	Operation	Header Data (7 bytes)				Command Data (6 bytes)			Description		
		Header Code	Packet	Data Size	CRC	Action	Type	Setting Code			
Picture	White Balance - Red Gain	Increment	BE EF	03	06 00	52 F4	04 00	B1 30	00 00		
		Decrement	BE EF	03	06 00	83 F5	05 00	B1 30	00 00		
		Get	BE EF	03	06 00	34 F4	02 00	B1 30	00 00		
	White Balance - Green Gain	Increment	BE EF	03	06 00	16 F4	04 00	B2 30	00 00		
		Decrement	BE EF	03	06 00	C7 F5	05 00	B2 30	00 00		
		Get	BE EF	03	06 00	70 F4	02 00	B2 30	00 00		
	White Balance - Blue Gain	Increment	BE EF	03	06 00	EA F5	04 00	B3 30	00 00		
		Decrement	BE EF	03	06 00	3B F4	05 00	B3 30	00 00		
		Get	BE EF	03	06 00	8C F5	02 00	B3 30	00 00		
	Aspect	Set	4:3	BE EF	03	06 00	9E D0	01 00	08 20	00 00	
			16:10	BE EF	03	06 00	3E D6	01 00	08 20	0A 00	
			16:9	BE EF	03	06 00	0E D1	01 00	08 20	01 00	
			Normal	BE EF	03	6 00	5E DD	01 00	08 20	10 00	
			Native	BE EF	03	6 00	5E D7	01 00	08 20	08 00	
		Get	BE EF	03	06 00	AD D0	02 00	08 20	00 00		
	Over Scan	Set	Off	BE EF	03	06 00	AB D4	01 00	1C 30	00 00	
			Crop	BE EF	03	06 00	3B D5	01 00	1C 30	01 00	
			Zoom	BE EF	03	06 00	CB D5	01 00	1C 30	02 00	
		Get	BE EF	03	06 00	98 D4	02 00	1C 30	00 00		
	V Position	Increment	BE EF	03	06 00	6B 83	04 00	00 21	00 00		
		Decrement	BE EF	03	06 00	BA 82	05 00	00 21	00 00		
		Get	BE EF	03	06 00	0D 83	02 00	00 21	00 00		
	H Position	Increment	BE EF	03	06 00	97 82	04 00	01 21	00 00		
		Decrement	BE EF	03	06 00	46 83	05 00	01 21	00 00		
		Get	BE EF	03	06 00	F1 82	02 00	01 21	00 00		
	H Phase	Increment	BE EF	03	06 00	2F 83	04 00	03 21	00 00		
		Decrement	BE EF	03	06 00	FE 82	05 00	03 21	00 00		
Get		BE EF	03	06 00	49 83	02 00	03 21	00 00			
H Size	Increment	BE EF	03	06 00	D3 82	04 00	02 21	00 00			
	Decrement	BE EF	03	06 00	02 83	05 00	02 21	00 00			
	Get	BE EF	03	06 00	B5 82	02 00	02 21	00 00			
Auto Adjust	Execute		BE EF	03	06 00	91 D0	06 00	0A 20	00 00		
Laser	Power Mode	Set	Eco	BE EF	03	06 00	AB 22	01 00	00 33	01 00	
			Normal	BE EF	03	06 00	3B 23	01 00	00 33	00 00	
			Custom	BE EF	03	06 00	3B 37	01 00	00 33	30 00	
		Get	BE EF	03	06 00	08 23	02 00	00 33	00 00		
	Power Level	Increment	BE EF	03	06 00	1A 22	04 00	07 33	00 00		
		Decrement	BE EF	03	06 00	CB 23	05 00	07 33	00 00		
		Get	BE EF	03	06 00	7C 22	02 00	07 33	00 00		
	High Altitude	Set	Normal	BE EF	03	06 00	E3 12	01 00	00 4C	00 00	
			High-1	BE EF	03	06 00	73 13	01 00	00 4C	01 00	
			High-2	BE EF	03	06 00	83 13	01 00	00 4C	02 00	
Auto			BE EF	03	06 00	23 1F	01 00	00 4C	10 00		
Get	BE EF	03	06 00	D0 12	02 00	00 4C	00 00				
Advanced	Installation	Set	Front Tabletop	BE EF	03	06 00	C7 D2	01 00	01 30	00 00	
			Front Ceiling	BE EF	03	06 00	37 D2	01 00	01 30	03 00	
			Rear Tabletop	BE EF	03	06 00	57 D3	01 00	01 30	01 00	
			Rear Ceiling	BE EF	03	06 00	A7 D3	01 00	01 30	02 00	
			Rear Ceiling	BE EF	03	06 00	A7 D3	01 00	01 30	02 00	
		Get	BE EF	03	06 00	F4 D2	02 00	01 30	00 00		

Communication settings

Communication command table (continue)

	Hitachi Command									Description	
	Function	Operation	Header Data (7 bytes)				Command Data (6 bytes)				
			Header Code	Packet	Data Size	CRC	Action	Type	Setting Code		
Advanced	Lens Control - Zoom	Increment	BE EF	03	06 00	96 92	04 00	01 24	00 00		
		Decrement	BE EF	03	06 00	47 93	05 00	01 24	00 00		
	Lens Control - Focus	Increment	BE EF	03	06 00	6A 93	04 00	00 24	00 00		
		Decrement	BE EF	03	06 00	BB 92	05 00	00 24	00 00		
	Lens Control - Shift V	Increment	BE EF	03	06 00	D2 92	04 00	02 24	00 00		
		Decrement	BE EF	03	06 00	03 93	05 00	02 24	00 00		
	Lens Control - Shift H	Increment	BE EF	03	06 00	2E 93	04 00	03 24	00 00		
		Decrement	BE EF	03	06 00	FF 92	05 00	03 24	00 00		
	Lens Memory Index	Set	1	BE EF	03	06 00	4B 92	01 00	07 24	00 00	
			2	BE EF	03	06 00	DB 93	01 00	07 24	01 00	
			3	BE EF	03	06 00	2B 93	01 00	07 24	02 00	
			4	BE EF	03	06 00	BB 92	01 00	07 24	03 00	
			5	BE EF	03	06 00	8B 90	01 00	07 24	04 00	
		Get	BE EF	03	06 00	78 92	02 00	07 24	00 00		
	Lens Memory Load	Execute	BE EF	03	06 00	E8 90	06 00	08 24	00 00		
	Lens Memory Save	Execute	BE EF	03	06 00	14 91	06 00	09 24	00 00		
	Lens Memory Clear	Execute	BE EF	03	06 00	50 91	06 00	0A 24	00 00		
	Lens Centering	Execute	BE EF	03	06 00	B8 93	06 00	04 24	00 00		
	Gamma	Set	1.0	BE EF	03	06 00	FB DB	01 00	A0 30	64 00	
			1.8	BE EF	03	06 00	3B 86	01 00	A0 30	B4 00	
			2.0	BE EF	03	06 00	FB A6	01 00	A0 30	C8 00	
			2.2	BE EF	03	06 00	FB A9	01 00	A0 30	DC 00	
			2.35	BE EF	03	06 00	CB BF	01 00	A0 30	EB 00	
			2.5	BE EF	03	06 00	9B B3	01 00	A0 30	FA 00	
		Dicom Sim.	BE EF	03	06 00	8B F0	01 00	A0 30	FF FF		
	Get	BE EF	03	06 00	08 F1	02 00	A0 30	00 00			
	Pattern	Set	Off	BE EF	03	06 00	FB FA	01 00	80 30	00 00	
			White	BE EF	03	06 00	0B F5	01 00	80 30	17 00	
			Black	BE EF	03	06 00	FB F0	01 00	80 30	18 00	
			Red	BE EF	03	06 00	FB F5	01 00	80 30	14 00	
			Green	BE EF	03	06 00	6B F4	01 00	80 30	15 00	
			Blue	BE EF	03	06 00	9B F4	01 00	80 30	16 00	
			Checkerboard	BE EF	03	06 00	AB F3	01 00	80 30	1D 00	
			CrossHatch	BE EF	03	06 00	5B F6	01 00	80 30	12 00	
			V Burst	BE EF	03	06 00	CB F7	01 00	80 30	13 00	
			H Burst	BE EF	03	06 00	5B F3	01 00	80 30	1E 00	
		Color Bar	BE EF	03	06 00	AB F6	01 00	80 30	11 00		
	Get	BE EF	03	06 00	C8 FA	02 00	80 30	00 00			
	Red Hue	Increment	BE EF	03	06 00	6A 63	04 00	00 27	00 00		
		Decrement	BE EF	03	06 00	BB 62	05 00	00 27	00 00		
		Get	BE EF	03	06 00	0C 63	02 00	00 27	00 00		
	Red Saturation	Increment	BE EF	03	06 00	AA 67	04 00	10 27	00 00		
		Decrement	BE EF	03	06 00	7B 66	05 00	10 27	00 00		
		Get	BE EF	03	06 00	CC 67	02 00	10 27	00 00		
	Red Gain	Increment	BE EF	03	06 00	AA 68	04 00	20 27	00 00		
		Decrement	BE EF	03	06 00	7B 69	05 00	20 27	00 00		
		Get	BE EF	03	06 00	CC 68	02 00	20 27	00 00		
Green Hue	Increment	BE EF	03	06 00	D2 62	04 00	02 27	00 00			
	Decrement	BE EF	03	06 00	03 63	05 00	02 27	00 00			
	Get	BE EF	03	06 00	B4 62	02 00	02 27	00 00			

Communication settings

Communication command table (continue)

	Hitachi Command									Description
	Function	Operation	Header Data (7 bytes)				Command Data (6 bytes)			
			Header Code	Packet	Data Size	CRC	Action	Type	Setting Code	
Advanced	Green Saturation	Increment	BE EF	03	06 00	12 66	04 00	12 27	00 00	
		Decrement	BE EF	03	06 00	C3 67	05 00	12 27	00 00	
		Get	BE EF	03	06 00	74 66	02 00	12 27	00 00	
	Green Gain	Increment	BE EF	03	06 00	12 69	04 00	22 27	00 00	
		Decrement	BE EF	03	06 00	C3 68	05 00	22 27	00 00	
		Get	BE EF	03	06 00	74 69	02 00	22 27	00 00	
	Blue Hue	Increment	BE EF	03	06 00	5A 62	04 00	04 27	00 00	
		Decrement	BE EF	03	06 00	8B 63	05 00	04 27	00 00	
		Get	BE EF	03	06 00	3C 62	02 00	04 27	00 00	
	Blue Saturation	Increment	BE EF	03	06 00	9A 66	04 00	14 27	00 00	
		Decrement	BE EF	03	06 00	4B 67	05 00	14 27	00 00	
		Get	BE EF	03	06 00	FC 66	02 00	14 27	00 00	
	Blue Gain	Increment	BE EF	03	06 00	9A 69	04 00	24 27	00 00	
		Decrement	BE EF	03	06 00	4B 68	05 00	24 27	00 00	
		Get	BE EF	03	06 00	FC 69	02 00	24 27	00 00	
	Cyan Hue	Increment	BE EF	03	06 00	2E 63	04 00	03 27	00 00	
		Decrement	BE EF	03	06 00	FF 62	05 00	03 27	00 00	
		Get	BE EF	03	06 00	48 63	02 00	03 27	00 00	
	Cyan Saturation	Increment	BE EF	03	06 00	EE 67	04 00	13 27	00 00	
		Decrement	BE EF	03	06 00	3F 66	05 00	13 27	00 00	
		Get	BE EF	03	06 00	88 67	02 00	13 27	00 00	
	Cyan Gain	Increment	BE EF	03	06 00	EE 68	04 00	23 27	00 00	
		Decrement	BE EF	03	06 00	3F 69	05 00	23 27	00 00	
		Get	BE EF	03	06 00	88 68	02 00	23 27	00 00	
	Magenta Hue	Increment	BE EF	03	06 00	A6 63	04 00	05 27	00 00	
		Decrement	BE EF	03	06 00	77 62	05 00	05 27	00 00	
		Get	BE EF	03	06 00	C0 63	02 00	05 27	00 00	
	Magenta Saturation	Increment	BE EF	03	06 00	66 67	04 00	15 27	00 00	
		Decrement	BE EF	03	06 00	B7 66	05 00	15 27	00 00	
		Get	BE EF	03	06 00	00 67	02 00	15 27	00 00	
	Magenta Gain	Increment	BE EF	03	06 00	66 68	04 00	25 27	00 00	
		Decrement	BE EF	03	06 00	B7 69	05 00	25 27	00 00	
		Get	BE EF	03	06 00	00 68	02 00	25 27	00 00	
	Yellow Hue	Increment	BE EF	03	06 00	96 62	04 00	01 27	00 00	
		Decrement	BE EF	03	06 00	47 63	05 00	01 27	00 00	
		Get	BE EF	03	06 00	F0 62	02 00	01 27	00 00	
	Yellow Saturation	Increment	BE EF	03	06 00	56 66	04 00	11 27	00 00	
		Decrement	BE EF	03	06 00	87 67	05 00	11 27	00 00	
		Get	BE EF	03	06 00	30 66	02 00	11 27	00 00	
	Yellow Gain	Increment	BE EF	03	06 00	56 69	04 00	21 27	00 00	
		Decrement	BE EF	03	06 00	87 68	05 00	21 27	00 00	
		Get	BE EF	03	06 00	30 69	02 00	21 27	00 00	
	White Gain R	Increment	BE EF	03	06 00	CA 6A	04 00	28 27	00 00	
		Decrement	BE EF	03	06 00	1B 6B	05 00	28 27	00 00	
		Get	BE EF	03	06 00	AC 6A	02 00	28 27	00 00	
	White Gain G	Increment	BE EF	03	06 00	72 6B	04 00	2A 27	00 00	
		Decrement	BE EF	03	06 00	A3 6A	05 00	2A 27	00 00	
		Get	BE EF	03	06 00	14 6B	02 00	2A 27	00 00	

Communication settings

Communication command table (continue)

		Hitachi Command								
Function	Operation	Header Data (7 bytes)				Command Data (6 bytes)			Description	
		Header Code	Packet	Data Size	CRC	Action	Type	Setting Code		
Advanced	White Gain B	Increment	BE EF	03	06 00	FA 6B	04 00	2C 27	00 00	
		Decrement	BE EF	03	06 00	2B 6A	05 00	2C 27	00 00	
		Get	BE EF	03	06 00	9C 6B	02 00	2C 27	00 00	
	H Keystone	Increment	BE EF	03	06 00	8F D0	04 00	0B 20	00 00	
		Decrement	BE EF	03	06 00	5E D1	05 00	0B 20	00 00	
		Get	BE EF	03	06 00	E9 D0	02 00	0B 20	00 00	
	V Keystone	Increment	BE EF	03	06 00	DF D3	04 00	07 20	00 00	
		Decrement	BE EF	03	06 00	0E D2	05 00	07 20	00 00	
		Get	BE EF	03	06 00	B9 D3	02 00	07 20	00 00	
	Rotation	Increment	BE EF	03	06 00	AB 99	04 00	70 21	00 00	
		Decrement	BE EF	03	06 00	7A 98	05 00	70 21	00 00	
		Get	BE EF	03	06 00	CD 99	02 00	70 21	00 00	
	H Pincushion / Barrel	Increment	BE EF	03	06 00	57 97	04 00	41 21	00 00	
		Decrement	BE EF	03	06 00	86 96	05 00	41 21	00 00	
		Get	BE EF	03	06 00	31 97	02 00	41 21	00 00	
	V Pincushion / Barrel	Increment	BE EF	03	06 00	9B 97	04 00	44 21	00 00	
		Decrement	BE EF	03	06 00	4A 96	05 00	44 21	00 00	
		Get	BE EF	03	06 00	FD 97	02 00	44 21	00 00	
	Top Left Corner - x	Increment	BE EF	03	06 00	57 89	04 00	21 21	00 00	
		Decrement	BE EF	03	06 00	86 88	05 00	21 21	00 00	
		Get	BE EF	03	06 00	31 89	02 00	21 21	00 00	
	Top Left Corner - y	Increment	BE EF	03	06 00	13 89	04 00	22 21	00 00	
		Decrement	BE EF	03	06 00	C2 88	05 00	22 21	00 00	
		Get	BE EF	03	06 00	75 89	02 00	22 21	00 00	
	Top Right Corner - x	Increment	BE EF	03	06 00	EF 88	04 00	23 21	00 00	
		Decrement	BE EF	03	06 00	3E 89	05 00	23 21	00 00	
		Get	BE EF	03	06 00	89 88	02 00	23 21	00 00	
	Top Right Corner - y	Increment	BE EF	03	06 00	9B 89	04 00	24 21	00 00	
		Decrement	BE EF	03	06 00	4A 88	05 00	24 21	00 00	
		Get	BE EF	03	06 00	FD 89	02 00	24 21	00 00	
	Bottom Left Corner - x	Increment	BE EF	03	06 00	67 88	04 00	25 21	00 00	
		Decrement	BE EF	03	06 00	B6 89	05 00	25 21	00 00	
		Get	BE EF	03	06 00	01 88	02 00	25 21	00 00	
	Bottom Left Corner - y	Increment	BE EF	03	06 00	23 88	04 00	26 21	00 00	
		Decrement	BE EF	03	06 00	F2 89	05 00	26 21	00 00	
		Get	BE EF	03	06 00	45 88	02 00	26 21	00 00	
	Bottom Right Corner - x	Increment	BE EF	03	06 00	DF 89	04 00	27 21	00 00	
		Decrement	BE EF	03	06 00	0E 88	05 00	27 21	00 00	
		Get	BE EF	03	06 00	B9 89	02 00	27 21	00 00	
	Bottom Right Corner - y	Increment	BE EF	03	06 00	CB 8A	04 00	28 21	00 00	
		Decrement	BE EF	03	06 00	1A 8B	05 00	28 21	00 00	
		Get	BE EF	03	06 00	AD 8A	02 00	28 21	00 00	
	Warping - Reset	Execute	BE EF	03	06 00	F1 99	06 00	72 21	00 00	
	Blanking - Top	Increment	BE EF	03	06 00	8A DA	04 00	2B 30	00 00	
		Decrement	BE EF	03	06 00	5B DB	05 00	2B 30	00 00	
		Get	BE EF	03	06 00	EC DA	02 00	2B 30	00 00	