

ViewSonic®

PJD2121 SVGA DLP Projector

- User Guide
- Guide de l'utilisateur
- Bedienungsanleitung
- Guía del usuario
- Руководство пользователя
- 使用手冊 (繁體)
- 使用手冊 (简体)

IMPORTANT: Please read this User Guide to obtain important information on installing and using your product in a safe manner, as well as registering your product for future service. Warranty information contained in this User Guide will describe your limited coverage from ViewSonic Corporation, which is also found on our web site at <http://www.viewsonic.com> in English, or in specific languages using the Regional selection box in the upper right corner of our website.

"Antes de operar su equipo lea cuidadosamente las instrucciones en este manual"



ViewSonic®

Model No.: VS12617

Compliance Information

FCC Statement

This device complies with part 15 of FCC Rules. Operation is subject to the following two conditions: (1) this device may not cause harmful interference, and (2) this device must accept any interference received, including interference that may cause undesired operation.

This equipment has been tested and found to comply with the limits for a Class B digital device, pursuant to part 15 of the FCC Rules. These limits are designed to provide reasonable protection against harmful interference in a residential installation. This equipment generates, uses, and can radiate radio frequency energy, and if not installed and used in accordance with the instructions, may cause harmful interference to radio communications. However, there is no guarantee that interference will not occur in a particular installation. If this equipment does cause harmful interference to radio or television reception, which can be determined by turning the equipment off and on, the user is encouraged to try to correct the interference by one or more of the following measures:

- Reorient or relocate the receiving antenna.
- Increase the separation between the equipment and receiver.
- Connect the equipment into an outlet on a circuit different from that to which the receiver is connected.
- Consult the dealer or an experienced radio/TV technician for help.

Warning: You are cautioned that changes or modifications not expressly approved by the party responsible for compliance could void your authority to operate the equipment.

For Canada

- This Class B digital apparatus complies with Canadian ICES-003.
- Cet appareil numérique de la classe B est conforme à la norme NMB-003 du Canada.

Following information is only for EU-member states:

The mark is in compliance with the Waste Electrical and Electronic Equipment Directive 2002/96/EC (WEEE).

The mark indicates the requirement NOT to dispose the equipment including any spent or discarded batteries or accumulators as unsorted municipal waste, but use the return and collection systems available.



If the batteries, accumulators and button cells included with this equipment, display the chemical symbol Hg, Cd, or Pb, then it means that the battery has a heavy metal content of more than 0.0005% Mercury or more than, 0.002% Cadmium, or more than 0.004% Lead.



Important Safety Instructions

1. Read these instructions.
2. Keep these instructions.
3. Heed all warnings.
4. Follow all instructions.
5. Do not use this unit near water.
6. Clean with a soft, dry cloth.
7. Do not block any ventilation openings. Install the unit in accordance with the manufacturer's instructions.
8. Do not install near any heat sources such as radiators, heat registers, stoves, or other devices (including amplifiers) that produce heat.
9. Do not defeat the safety purpose of the polarized or grounding-type plug. A polarized plug has two blades with one wider than the other. A grounding type plug has two blades and a third grounding prong. The wide blade and the third prong are provided for your safety. If the provided plug does not fit into your outlet, consult an electrician for replacement of the obsolete outlet.
10. Protect the power cord from being walked on or pinched particularly at plugs. Convenience receptacles and the point where they exit from the unit. Be sure that the power outlet is located near the unit so that it is easily accessible.
11. Only use attachments/accessories specified by the manufacturer.
12.  Use only with the cart, stand, tripod, bracket, or table specified by the manufacturer, or sold with the unit. When a cart is used, use caution when moving the cart/unit combination to avoid injury from tipping over.
13. Unplug this unit when unused for long periods of time.
14. Refer all servicing to qualified service personnel. Servicing is required when the unit has been damaged in any way, such as: if the power-supply cord or plug is damaged, if liquid is spilled onto or objects fall into the unit, if the unit is exposed to rain or moisture, or if the unit does not operate normally or has been dropped.

Declaration of RoHS Compliance

This product has been designed and manufactured in compliance with Directive 2002/95/EC of the European Parliament and the Council on restriction of the use of certain hazardous substances in electrical and electronic equipment (RoHS Directive) and is deemed to comply with the maximum concentration values issued by the European Technical Adaptation Committee (TAC) as shown below:

Substance	Proposed Maximum Concentration	Actual Concentration
Lead (Pb)	0.1%	< 0.1%
Mercury (Hg)	0.1%	< 0.1%
Cadmium (Cd)	0.01%	< 0.01%
Hexavalent Chromium (Cr ⁶⁺)	0.1%	< 0.1%
Polybrominated biphenyls (PBB)	0.1%	< 0.1%
Polybrominated diphenyl ethers (PBDE)	0.1%	< 0.1%

Certain components of products as stated above are exempted under the Annex of the RoHS Directives as noted below:

Examples of exempted components are:

1. Mercury in compact fluorescent lamps not exceeding 5 mg per lamp and in other lamps not specifically mentioned in the Annex of RoHS Directive.
2. Lead in glass of cathode ray tubes, electronic components, fluorescent tubes, and electronic ceramic parts (e.g. piezoelectronic devices).
3. Lead in high temperature type solders (i.e. lead-based alloys containing 85% by weight or more lead).
4. Lead as an alloying element in steel containing up to 0.35% lead by weight, aluminium containing up to 0.4% lead by weight and as a copper alloy containing up to 4% lead by weight.

Copyright Information

Copyright© ViewSonic® Corporation, 2009. All rights reserved.

Macintosh and Power Macintosh are registered trademarks of Apple Inc.

Microsoft, Windows, Windows NT, and the Windows logo are registered trademarks of Microsoft Corporation in the United States and other countries.

ViewSonic, the three birds logo, OnView, ViewMatch, and ViewMeter are registered trademarks of ViewSonic Corporation.

VESA is a registered trademark of the Video Electronics Standards Association. DPMS and DDC are trademarks of VESA.

PS/2, VGA and XGA are registered trademarks of International Business Machines Corporation.

Disclaimer: ViewSonic Corporation shall not be liable for technical or editorial errors or omissions contained herein; nor for incidental or consequential damages resulting from furnishing this material, or the performance or use of this product.

In the interest of continuing product improvement, ViewSonic Corporation reserves the right to change product specifications without notice. Information in this document may change without notice.

No part of this document may be copied, reproduced, or transmitted by any means, for any purpose without prior written permission from ViewSonic Corporation.

Product Registration

To meet your future needs, and to receive any additional product information as it becomes available, please register your product on the Internet at: www.viewsonic.com. The ViewSonic® Wizard CD-ROM also provides an opportunity for you to print the registration form, which you may mail or fax to ViewSonic.

For Your Records

Product Name:	PJD2121 ViewSonic SVGA DLP Projector
Model Number:	VS12617
Document Number:	PJD2121_UG_ENG Rev. 1A 06-12-09
Serial Number:	_____
Purchase Date:	_____



The lamp in this product contains mercury.

Please dispose of in accordance with local, state or federal laws.

Table of contents

Introduction..... 2	Menu operation..... 16
Projector features 2	Description of each menu..... 17
Shipping contents..... 3	Maintenance 18
Projector exterior view..... 4	Care of the projector..... 18
Controls and functions 5	Lamp information 18
Positioning your projector..... 7	Indicators 20
Choosing a location..... 7	Troubleshooting..... 21
Projection dimensions 7	Specifications..... 22
Connection 8	Projector specifications..... 22
Connecting a computer or monitor 8	Dimensions 23
Connecting Video source devices..... 9	Timing chart 23
Operation 10	Appendix..... 25
Starting up the projector..... 10	IR control table..... 25
Using the menus..... 10	
Switching input signal..... 11	
Adjusting the projected image 11	
Adjusting the projection angle 11	
Correcting keystone 12	
Selecting the aspect ratio..... 12	
Magnifying and searching for details..... 13	
Pan and Scan 13	
Optimizing the image..... 13	
Fine-tuning the image quality in user modes. 14	
Hiding the image 14	
Shutting down the projector 15	

Introduction

Projector features

The projector integrates high-performance optical engine projection and a user-friendly design to deliver high reliability and ease of use.

The projector offers the following features.

- Quick auto search speeding up the signal detecting process
- Digital keystone correction to correct distorted images
- Ability to display 16.7 million colors
- Multi-language On-Screen Display (OSD) menus
- Component HDTV compatibility (YPbPr)
- ViewMatch for Accurate Color Correction.
- Short throw projection lens.
- Easy to use.
- Compact size.

Shipping contents

Carefully unpack and verify that you have all of the items shown below. If any of these items are missing, please contact your place of purchase.

Standard accessories

The supplied accessories will be suitable for your region, and may differ from those illustrated.

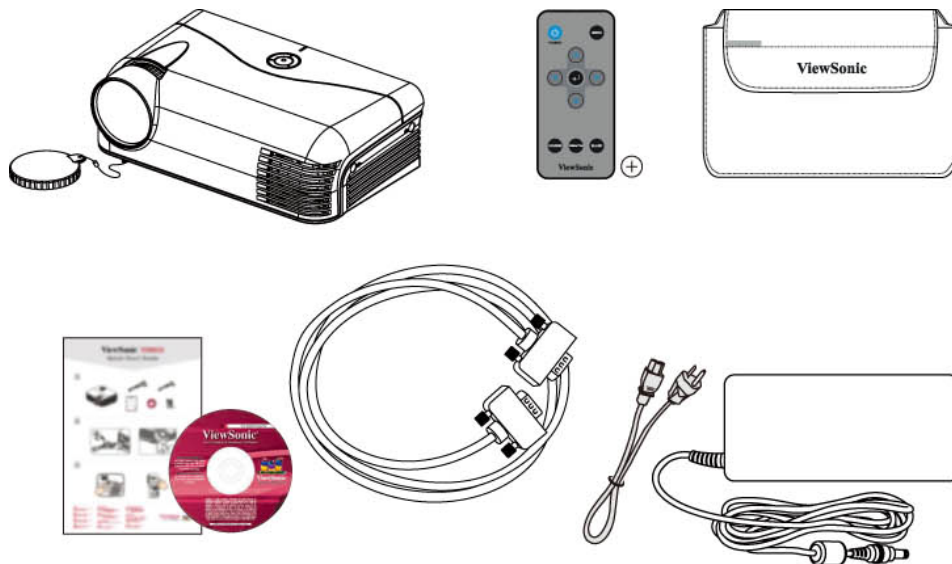

Optional accessories

Replacement lamp

Projector exterior view

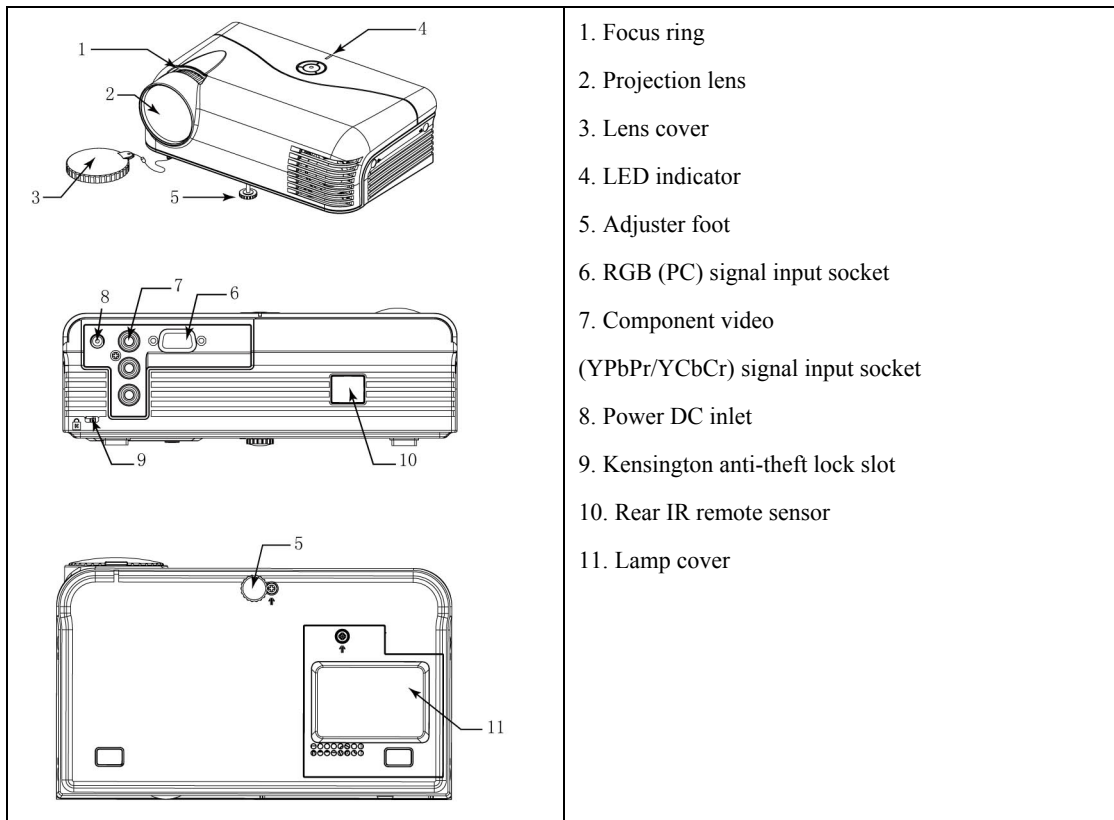

Controls and functions

Projector and remote control

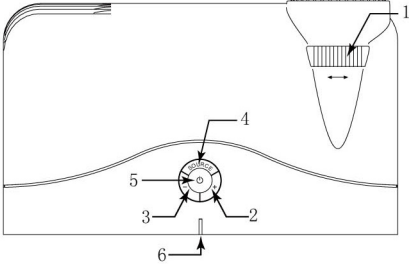
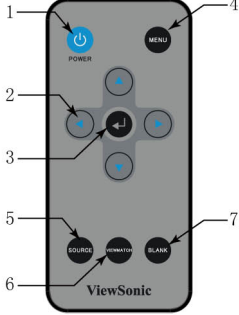
	
<p>1. Focus ring Adjusts the focus of the projected image. See "Fine-tuning the image size and clarity" on page 15 for details.</p> <p>2. Keystone + Manually corrects distorted images resulting from an angled projection.</p> <p>3. Keystone – Manually corrects distorted images resulting from an angled projection.</p> <p>4. SOURCE Displays the source selection bar. See "Switching input signal" on page 15 for details.</p> <p>5. Power button To turn on/off power.</p> <p>6. Temperature/Power indicator light Lights up red if the projector's temperature becomes too high. See "Indicators" on page 22 for details.</p>	<p>1. POWER To turn on/off power.</p> <p>2. Arrow keys (Left/Right/ Up /Down) Selects the desired menu items and makes adjustments.</p> <p>3. Enter Selects an available OSD function setup mode.</p> <p>4. MENU/EXIT Turns on the On-Screen Display (OSD) menu. Goes back to previous OSD menu, exits and saves menu settings. See "Using the menus" on page 14 for details.</p> <p>5. Source Displays the source selection bar. See "Switching input signal" on page 15 for details.</p> <p>6. ViewMatch Switch in between high brightness performance or Accuracy color performance.</p> <p>7. BLANK Hides the screen picture. See "Hiding the image" on page 18 for details.</p>

Remote control effective range

Infra-Red (IR) remote control sensor is located on the Back of the projector. The remote control must be held at an angle within 30 degrees perpendicular to the projector's IR remote control sensor to function correctly. The distance between the remote control and the sensor should not exceed 8 meters (~ 26 feet). Make sure that there are no obstacles between the remote control and the IR sensor on the projector that might obstruct the infra-red

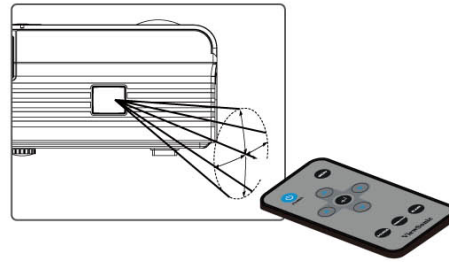

Replacing the Battery

1. Pull out the battery, **Please follow the illustrated instructions. Push and hold the locking arm while pulling out the battery holder.**
2. Insert the new battery in the holder. Note the positive polarity should face outward.

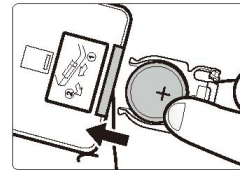
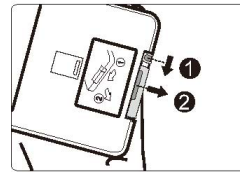

Positioning your projector

Choosing a location

Your room layout or personal preference will dictate which installation location you select.

Take into consideration the size and position of your screen, the location of a suitable power outlet, as well as the location and distance between the projector and the rest of your equipment.

Your projector is designed to be installed in the following installation locations:

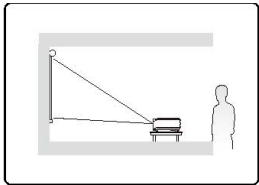
<p>1. Front Table</p> <p>Select this location with the projector placed near the floor in front of the screen. This is the most common way to position the projector for quick setup and portability.</p>	
--	--

Projection dimensions

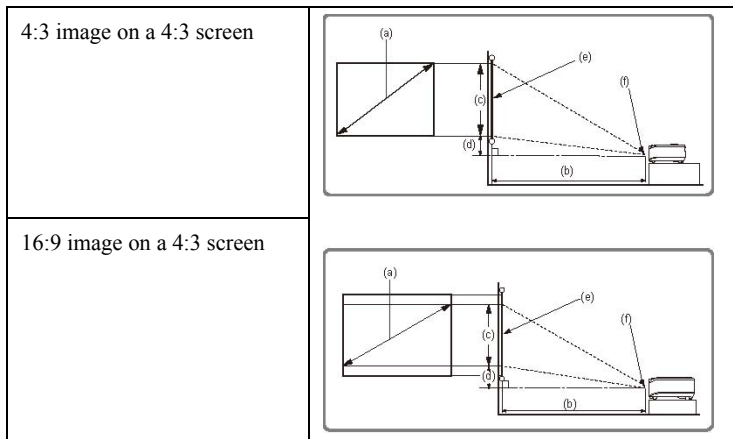

(e): Screen (f): Center of lens

(a)Image Diagonal [inch(m)]	4:3 Screen			16:9 Screen		
	(b)Projection Distance [m(inch)]	(c)image height [cm(inch)]	(d)Vertical offset [cm(inch)]	(b)Projection Distance [m(inch)]	(c)image height [cm(inch)]	(d)Vertical offset [cm(inch)]
40 (1.0)	0.8 (32)	61 (24)	5 (2)	0.88(34.6)	48(18.9)	9.5(3.7)
60 (1.3)	1.2 (48)	91 (36)	7 (3)	1.34(52.8)	74(29)	13(5)
80 (1.5)	1.6 (64)	122 (48)	9 (4)	1.8(70.9)	98(38.6)	17(6.7)
100 (1.8)	2.0(79)	152(60)	11(4.3)	2.26(89)	121(47.6)	21.5(8.5)
120 (2.0)	2.4 (94)	183(72)	14(5.5)	2.72(107)	142(55.9)	25.5(10)
150 (2.0)	3.0(118)	229(90)	17(6.7)	3.4(134.3)	160(63)	32.3(12.7)

There is +/- 2% tolerance among these numbers due to optical component variations.

This will help you determine the exact mounting position so that it best suits your installation location.

Connection

When connecting a signal source to the projector, be sure to:

- 1 Turn all equipment off before making any connections.
- 2 Use the correct signal cables for each source.
- 3 Ensure the cables are firmly inserted.

 In the connections shown below, some cables may not be included with the projector (see "Shipping contents" on page 5.) They are commercially available from electronics stores.

Connecting a computer or monitor

Connecting a computer

The projector provides one VGA input socket that allow you to connect them to both IBM® compatibles and Macintosh® computers. A Mac adapter is needed if you are connecting legacy version Macintosh computers.

To connect the projector to a notebook or desktop computer:

- 1 Take the supplied VGA cable and connect one end to the D-Sub output socket of the computer.
- 2 Connect the other end of the VGA cable to the VGA signal input socket on the projector.

The final connection path should be like that shown in the following diagram:

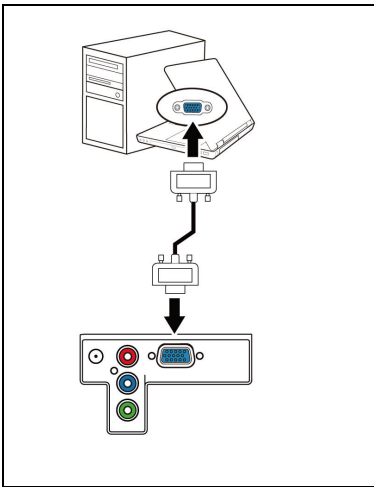

 Many notebooks do not turn on their external video ports when connected to a projector.

Refer to your notebook's documentation to switch between monitor and projector.

Connecting a Component Video source device

The projector provides one Component input socket that allows you to connect Component Video output from DVD player or other equipment.

- Make sure you have Component cable; this cable is not a standard part in shipping content.

The final connection path should be like that shown in the following diagram:

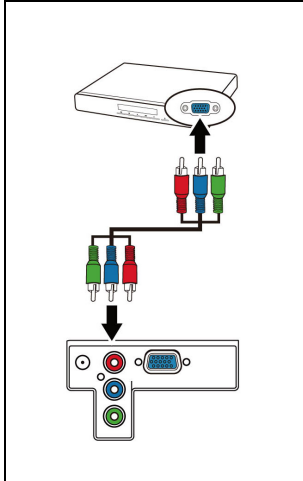

Operation

Starting up the projector

1. Plug the power cord into the projector and into a wall socket and power adaptor. Plug DC jack to projector. Check that the **POWER indicator light** on the projector flashes blue after power has been applied.
2. Remove the lens cap. If it is closed, it could become deformed due to the heat produced by the projection lamp.
3. Press POWER on the projector or remote control to start the projector. The POWER indicator light stays blue when the projector is on. The start up procedure takes about 20 seconds. In the later stage of start up, a startup logo is projected. (If necessary) Rotate the focus ring to adjust the image clearness.

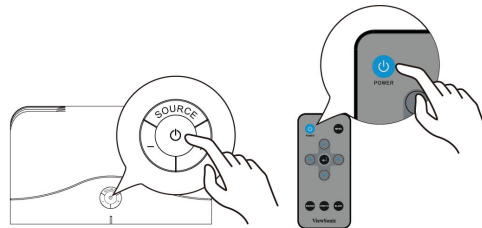
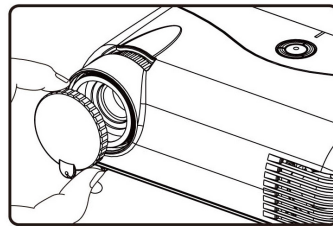
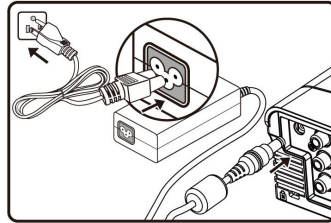

If the frequency/resolution of the input signal exceeds the projector's operating range, you will see the message "Signal out of range", please set the computer output to 800X600'

Use the Menu



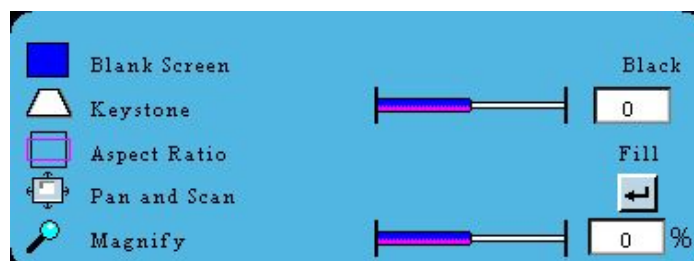

The projector is equipped with On-Screen Display (OSD) menus for making various adjustments and settings. Below is the overview of the OSD menu.

Important: Use ◀▶ to highlight function and press Enter to select.

Main menu icon

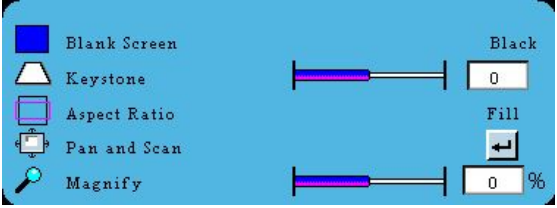

To use the OSD menus, please set them to your familiar language first.

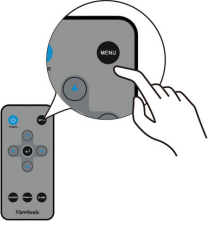
<p>1. Press MENU on the remote control to turn on the OSD. Press Enter to select.</p>  	<p>3. Press ▼ to select the language you need and press Enter.</p> 
<p>2. Use ◀▶ to highlight the LANGUAGE, press Enter to select.</p>  	<p>4. Press MENU on the remote control to leave and save the settings.</p> 

Switching input signal

The projector can be connected to multiple devices at the same time. However, it can only display one full screen at a time.

Be sure the **Auto Source Select** function in the **Advance** menu is **On** (which is the default of this projector) if you want the projector to automatically search for the signals.

You can also manually cycle through the available input signals. Press **SOURCE** on the projector or remote control.

Adjusting the projected image

Adjusting the projection angle

The projector is equipped with 1 adjuster foot. This adjuster changes the image height and projection angle. To adjust the projector:

Screw the front adjuster foot to adjust the height.

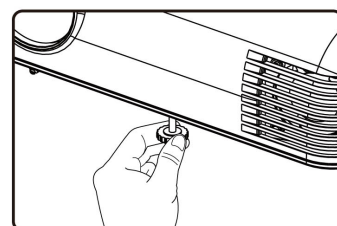

If the projector is not placed on a flat surface or the screen and the projector are not perpendicular to each other, the projected image becomes trapezoidal.

Do not look into the lens while the lamp is on. The strong light from the lamp may cause damage to your eyes. Be careful when you press the adjuster button as it is close to the exhaust vent where hot air comes from.

Fine-tuning the image size and clarity

Sharpen the image by rotating the focus ring.

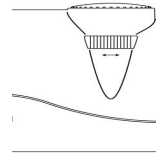

Correcting keystone

Keystoning refers to the situation where the projected image is noticeably wider at either the top or bottom. It occurs when the projector is not perpendicular to the screen. To correct this, press + / - on the projector.

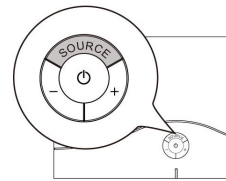

Selecting the aspect ratio

The 'aspect ratio' is the ratio of the image width to the image height. Most analog TV and computers are in 4:3 ratio, which is the default for this projector, and digital TV and DVDs are usually in 16:9 ratio

With the advent of digital signal processing, digital display devices like this projector can dynamically stretch and scale the image output to a different aspect than that of the image input signal.

To change the projected image ratio (no matter what aspect the source is):

Press **MENU** and then press ◀▶ until the **DISPLAY** menu is highlighted and press Enter.

Press ▼ to highlight **Aspect Ratio**.

Select an aspect ratio to suit the format of the video signal and your display requirements.

About the aspect ratio

 In the pictures below, the black portions are inactive areas and the white portions are active areas. OSD menus can be displayed on those unused black areas.

<p>1 Fill: Scales an image to fill the projection size no matter the aspect ratio is 4:3 or 16:9.</p>	
<p>2 Native: Scales an image proportionally to fit the projector's native resolution in its horizontal width.</p>	
<p>3 4:3: Scales an image so that it is displayed in the center of the</p>	

screen with a 4:3 aspect ratio. This is most suitable for 4:3 images like computer monitors, standard definition TV and 4:3 aspect DVD movies, as it displays them without aspect alteration.

4 **16:9:** Scales an image so that it is displayed in the center of the screen with a 16:9 aspect ratio. This is most suitable for images which are already in a 16:9 aspect, like high definition TV, as it displays them without aspect alteration.

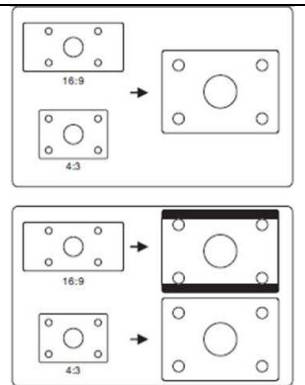

Magnifying and searching for details

If you need to zoom in the details on the projected picture, magnify the picture. Use the direction arrow keys for navigating the picture.

1. Press **MENU** until the **DISPLAY** menu is highlighted and press Enter.
2. Press **▼** to highlight **Magnify** and press **◀▶** to select a desired value.

Pan and Scan

When you zoom in the detail on the projected picture, you may use Pan and Scan to see the details.

1. Press **MENU** until the **DISPLAY** menu is highlighted.
2. Press **▼** to highlight **Pan and Scan** and press Enter.
3. Press **◀▶** to select a desired value.

Optimizing the image

Selecting a picture mode

The projector is preset with several predefined picture modes so that you can choose one to suit your operating environment and input signal picture type.

To select an operation mode that suits your need, you can follow one of the following steps.

Press **MENU** on the remote control or projector repeatedly until your desired mode is selected.

Go to the **PICTURE > Image** menu, press **ENTER** and **◀▶** to select a desired mode.

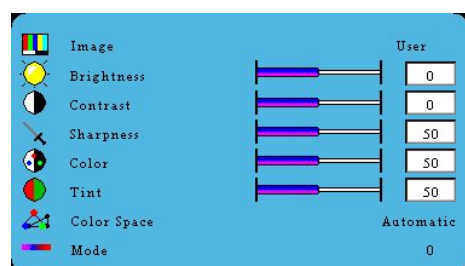

Picture modes for different types of signals

The picture modes available for different types of signals are listed below.

- 1 **VGA (Default):** Maximizes the brightness of the projected image. This mode is suitable for presentation.
- 2 **ViewMatch mode:** Switch in between high brightness performance or Accuracy color performance.
- 3 **Video:** Is appropriate for playing colorful movies, video clips from digital cameras or DVs through the PC input for best viewing in a blackened (little light) environment.
- 4 **User:** Allows user to adjust prefer picture modes. See "Setting the User mode" on the following for details.

Setting the User mode



There is one user-definable mode if the current available picture modes are not suitable for your need. You can use one of the picture modes (except the **User**) as a starting point and customize the settings

1. Press **MENU** to open the On-Screen Display (OSD) menu
2. Go to the **PICTURE > Image** menu and press Enter.
3. Press **◀ ▶** to select **User**.
4. Press **▼** to select a sub-menu item to be changed and adjust the value with **◀ ▶**.

 This function is only available when User mode is selected up in the Picture Mode sub-menu item.

Fine-tuning the image quality in user modes

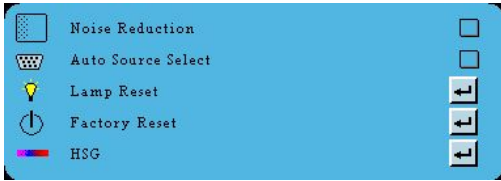
Adjusting color

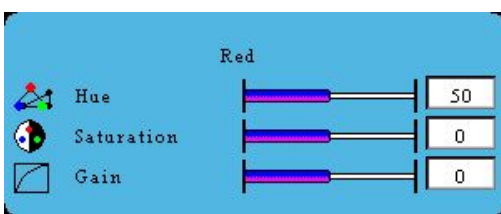
<p>1. Go to the ADVANCE > HSG menu.</p>	
<p>2. Press ◀ ▶ to select color you want to adjust. There are 7 color can be adjusted.</p>	
<p>3. Press ▼ to select a sub-menu item to be changed and adjust the value with ◀ ▶</p> <p>Please be noticed this is one of the colors.</p>	

Hiding the image

In order to draw the audience's full attention to the presenter, you can use **BLANK** on the remote control to hide the screen. Press again to restore.

Shutting down the projector

Press **POWER** and a confirmation message displays prompting you. If you don't respond in a few seconds, the message will disappear.

Press **POWER** a second time. The **POWER indicator light** flashes RED, the projection lamp shuts down, and the fans will continue to run for approximately 60 seconds to cool down the projector.

Disconnect the power cord from the wall socket if the projector will not be used in an extended period of time.

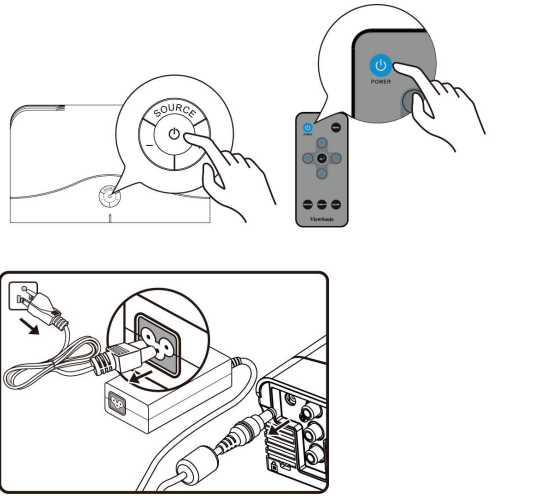











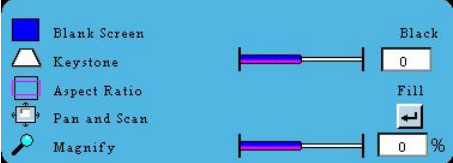

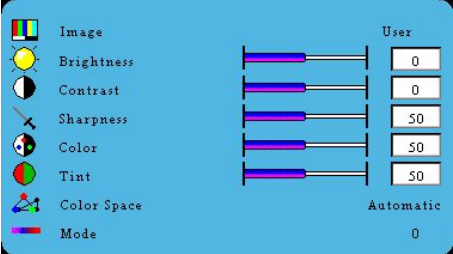
Menu operation

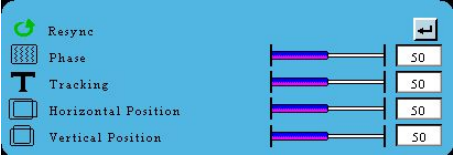
Menu system

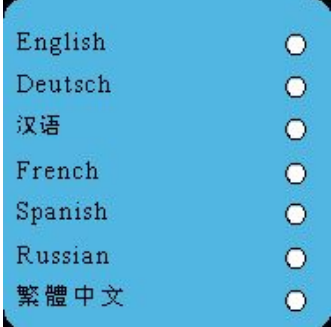
Please note that the on-screen display (OSD) menus vary according to the signal type selected.

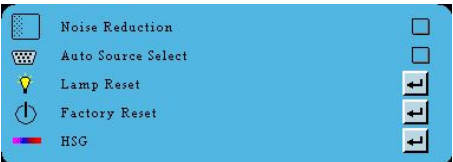
The menu items are available when the projector detects at least one valid signal. If there is no equipment connected to the projector or no signal detected, limited menu items are accessible.

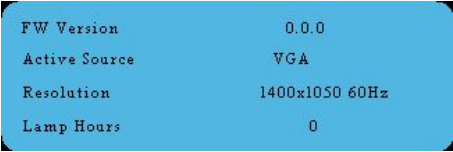
Main menu	Sub-menu Options	
		
1. DISPLAY		
2. PICTURE		
3. Resync (VGA Input only)		
4. Language		
5. Advance		
6. About		

Description of each menu

Feature	Description	min	Max	Default
Blank Screen	Allows you to select which logo screen will display during projector start-up.	N/A	N/A	ViewSonic
Keystone	Vertical Keystone function by using DDP2230 of “TP” chip to provide vertical keystone correction	-30	+30	0°
Aspect Ratio	Aspect Ratio allows the user to set the aspect ratio of the image displayed on the projector. This is helpful when the input resolution is not at the native resolution of the content or if the user wishes to fill the projector. 1. Fill 2. Native 3. 4:3 4. 16:9	N/A	N/A	Fill
Magnify	To zoom in the details one the projected screen.	0	100	0
Mode	User can choose different mode. Such as User, VGA, Video and ViewMatch.	N/A	N/A	PC: VGA Component: Video
Brightness	When Picture mode is selected on User mode, this function can be active. Adjusts the brightness of the image. The higher the setting the brighter the image. And the lower the setting, the darker the image.	-100	100	0
Contrast	When Picture mode is selected on User mode, this function can be active. Adjusts the degree of difference between the dark and light in the image. The higher the value, the greater the contrast.	-50	50	0
Sharpness	When Picture mode is selected on User mode, this function can be active. Adjusts the image to make it look sharper. (At higher values, will switch to Detail Enhancement)	0	31	16
Color Space	User can set different Color Space such as Auto, RGB, YCbCr and YPbPr.	N/A	N/A	Automatic
Noise Reduction	Reduce signal noise. But depends on the input signal.	ON	OFF	ON
Lamp Reset	To reset the lamp hours after replaced the lamp.	NA	NA	NA
Factory Reset	Return to the factory pre-set value.	NA	NA	NA
HSG	Refer to Page 16, “Fine-tuning the image quality in user modes”	NA	NA	NA
Active Source	Shows the input source. 1. VGA 2. Component	NA	NA	NA
Resolution	Shows the current input resolution.	NA	NA	NA
Lamp Hours	Shows the current lamp using hours.	NA	NA	NA

The following setup value will be changed after calibration.

Phase	Adjusts the clock phase to reduce image distortion.
Tracking	Adjusts the image size to fit the screen
Horizontal Position	Adjusts the horizontal width of the image.
Vertical Position	Adjusts the Vertical width of the image.

Maintenance

Care of the projector

Your projector needs little maintenance. The only thing you need to do on a regular basis is to keep the lens clean.

Never remove any parts of the projector except the lamp. Contact your dealer if other parts need replacing.

Cleaning the lens

Clean the lens whenever you notice dirt or dust on the surface.

Use a canister of compressed air to remove dust.

If there is dirt or smears, use lens-cleaning paper or moisten a soft cloth with lens cleaner and gently wipe the lens surface.

Cleaning the projector case

Before you clean the case, turn the projector off using the proper shutdown procedure as described in "Shutting down the projector" on page 8 and unplug the power cord.

To remove dirt or dust, wipe the case with a soft, lint-free cloth.

To remove stubborn dirt or stains, moisten a soft cloth with water and a neutral pH detergent. Then wipe the case.

Storing the projector

If you need to store the projector for an extended time, please follow the instructions below:

Make sure the temperature and humidity of the storage area are within the recommended range for the projector. Please refer to "Specifications" on page 25 or consult your dealer about the range.

Retract the adjuster feet.

Remove the battery from the remote control.

Pack the projector in its original packing or equivalent.

Transporting the projector

It is recommended that you ship the projector with its original packing or equivalent.

Lamp information

Getting to know the lamp hour

When the projector is in operation, the duration (in hours) of lamp usage is automatically calculated by the built-in timer.

To obtain the lamp hour information:

Press **MENU** and then press ► until the **About** menu is highlighted. You will see the lamp hours.

Timing of replacing the lamp

When the lamp's total working time accumulates to over 2000 hours, the On-Screen Display (OSD) will deliver a message recommending that you replace the lamp. Please contact a service center to replace the lamp as soon as possible

The following lamp warning displays will remind you to change the lamp.

Status	Message
The lamp has been in operation for 2000 hours. Install a new lamp for optimal performance. You may continue to operate the projector.	Please change the lamp Please replace the lamp

Replacing the lamp

Type number : RLC-052

To reduce the risk of injuries to fingers and damage to internal components, use caution when removing lamp glass that has shattered into sharp pieces. Before replacing the lamp, clean the lamp compartment and dispose of cleaning materials. Be careful of sharp edges in the lamp compartment. Wash hands after lamp replacement.

Only ViewSonic certified lamps are tested with this projector. Use of other lamps may cause electrical shock and fire.

Turn the power off and disconnect the projector from the wall socket before replace the lamp. Follow with below instruction.. Contact your dealer for details.

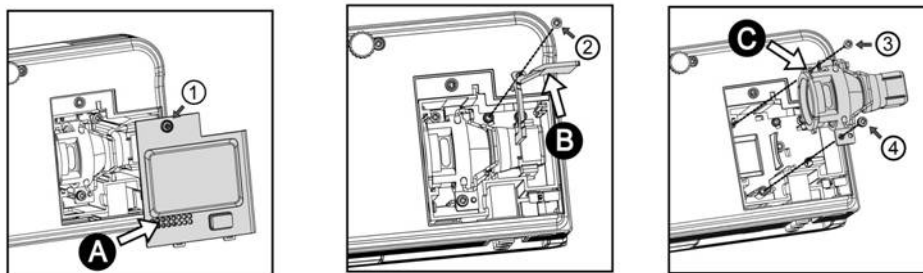

Resetting the lamp timer

1. Press **MENU** to open the On-Screen Display (OSD) menu
2. Go to the **Advance** menu and press Enter.
3. Press **▼** to select **Lamp Reset** and press Enter.

Indicators

Light	Status & Description
Power events	
Flashing blue (1 sec interval)	Stand-by mode
Blue	Powering up
Blue	Normal operation
Red	This projector needs 60 seconds to cool down.
Lamp events	
Flashing blue (10 sec interval)	This projector will go into hot-ignite by 4 times.
Thermal events	
Purple	The projector needs 60 seconds to cool down. Or
Flashing red (1 sec interval)	Please contact your dealer for assistance.

Troubleshooting

- The projector does not turn on.

Cause	Remedy
There is no power from the power cord.	Plug the power cord into the AC inlet on the projector, and plug the power cord into the power outlet.
Attempting to turn the projector on again during the cooling process.	Wait until the cooling down process has completed.

- No picture

Cause	Remedy
The video source is not turned on or connected correctly.	Turn the video source on and check that the signal cable is connected correctly.
The projector is not correctly connected to the input signal device.	Check the connection.
The input signal has not been correctly selected.	Select the correct input signal with the SOURCE key on the projector or remote control.
The lens cover is still closed.	Open the lens cover.

- Blurred image

Cause	Remedy
The projection lens is not correctly focused.	Adjust the focus of the lens using the focus ring.
The projector and the screen are not aligned properly.	Adjust the projection angle and direction as well as the height of the projector if necessary.
The lens cover is still closed.	Open the lens cover.

- Remote control does not work

Cause	Remedy
The battery is out of power.	Replace the battery with a new one.
There is an obstacle between the remote control and the projector.	Remove the obstacle.
You are too far away from the projector.	Stand within 6 meters of the projector.

Specifications

Projector specifications

 All specifications are subject to be changed without notice.

General	
Product name	Digital Projector
Model name	PJD2121
Optical	
Resolution	800 x 600 SVGA
Display system	1-CHIP DMD
Lens F/Number	F = 2.6
Lamp	50W lamp
Electrical	
Power supply	AC Adaptor 100–240V, Input 19V==4.74A
Power consumption	90 W (Max)
Mechanical	
Dimensions	205 mm (W) x 65 mm (H) x 121 mm (D)
Weight	2.2 lbs (1.0 Kg)
Input terminal	
Computer input	
RGB input	D-Sub 15-pin (female) x 1
Video signal input	
VIDEO	RCA jack x 1
Environmental Requirements	
Operating temperature	0°C–40°C at sea level
Operating relative humidity	10%–90% (without condensation)
Operating altitude	• 0–1499 m at 0°C–35°C • 1500–3000 m at 0°C–30°C

Dimensions

205 mm (W) x 65 mm (H) x 121 mm (D)

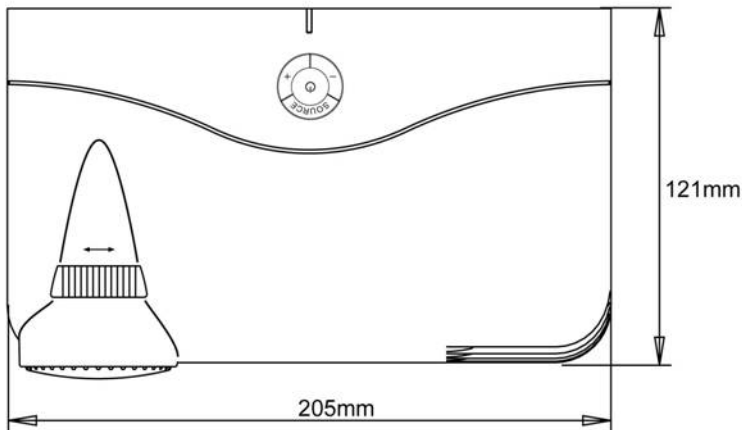
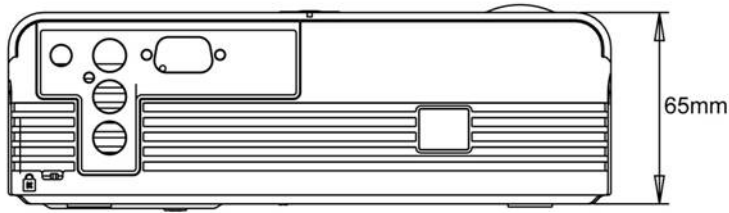

Timing chart

Mode	Resolution	V-Sync (Hz)	H Sync (kHz)
VGA (Expanded) DOS/Text mode visible	640x350	70	31.5
	640x350	85	37.9
	640x400	85	37.9
	640x480	60	31.5
	640x480	72	37.9
	640x480	75	37.5
	640x480	85	43.3
	720x400	70	31.5
	720x400	85	37.9
SVGA (Native)	800x600	56	35.2
	*800x600	60	37.9
	800x600	72	48.1
	800x600	75	46.9
	800x600	85	53.7

XGA (Compressed)	1024x768	60	48.4
	1024x768	70	56.5
	1024x768	75	60.0
	1024x768	85	68.7
SXGA (Compressed)	1280x1024	60	64
	1280x1024	75	80
UXGA	1600x1200	60	75
Mac, Apple	640*480	67	35
	832x624	75	49.7
	1024x768	75	60
	1152x870	75	68.68
	1280x960	75	75
Others**	1280x800	60	49.67
	1440x900	60	55.91
	1680x1050	60	65.29
PC: Full scan			
7.4 Compatible/Supportive Modes			
Note: the Projector may need minor adjustment in the OSD to get optimized performance.			
1080i	1920x1080	30	33.75
1080i	1920x1080	25	28.13
720p	1280x720	60	45
720p	1280x720	50	37.5
480p	640x480	60	31.5
480i	640x480	30	15.75
576i	720x576	25	15.75
576p	720x576	50	31.25

Appendix

IR control table

Key	1st Byte	2nd Byte	3rd Byte
POWER	83	F4	0x02
MENU	83	F4	0x0F
UP (VOL+)	83	F4	0x11
DOWN (VOL-)	83	F4	0x14
LEFT	83	F4	0x16
RIGHT	83	F4	0x18
ENTER	83	F4	0x10
SOURCE	83	F4	0x04
VIEWMATCH	83	F4	0x19
BLANK	83	F4	0x1A

Customer Support

For technical support or product service, see the table below or contact your reseller.

Note : You will need the product serial number.

Country/Region	Web Site	T=Telephone F=Fax	E-mail
Australia/New Zealand	www.viewsonic.com.au	AUS=1800 880 818 NZ=0800 008 822	service@au.viewsonic.com
Canada	www.viewsonic.com	T (Toll-Free)= 1-866-463-4775 T (Toll)= 1-424-233-2533 F= 1-909-468-1202	service.ca@viewsonic.com
Europe/Middle East/Baltic countries/North Africa	www.viewsoniceurope.com	Contact your reseller	
Hong Kong	www.hk.viewsonic.com	T= 852 3102 2900	service@hk.viewsonic.com
India	www.in.viewsonic.com	T= 1800 11 9999	service@in.viewsonic.com
Korea	www.kr.viewsonic.com	T= 080 333 2131	service@kr.viewsonic.com
Latin America (Argentina)	www.viewsonic.com/la/	T= 0800 666 0194	soporte@viewsonic.com
Latin America (Brazil)	www.viewsonic.com/la/	T= 0800 891 6984	soporte@viewsonic.com
Latin America (Chile)	www.viewsonic.com/la/	T= 800 440 303	soporte@viewsonic.com
Latin America (Columbia)	www.viewsonic.com/la/	T= 01 800 915 6588	soporte@viewsonic.com
Latin America (Mexico)	www.viewsonic.com/la/	T= 001 800 514 6518	soporte@viewsonic.com
Renta y Datos, 29 SUR 721, COL. LA PAZ, 72160 PUEBLA, PUE. Tel: 01.222.891.55.77 CON 10 LINEAS Electroser, Av Reforma No. 403Gx39 y 41, 97000 Merida, Yucatan. Tel: 01.999.925.19.16 Other places please refer to http://www.viewsonic.com/la/soporte/index.htm#Mexico			
Latin America (Peru)	www.viewsonic.com/la/	T= 0800 53458	soporte@viewsonic.com
Macau	www.hk.viewsonic.com	T= 853 700 303	service@hk.viewsonic.com
Puerto Rico & Virgin Islands	www.viewsonic.com	T= 1-800-688-6688 (English) T= 1-866-379-1304 (Spanish) F= 1-909-468-1202	service.us@viewsonic.com soporte@viewsonic.com
Singapore/Malaysia/Thailand	www.ap.viewsonic.com	T= 65 6461 6044	service@sg.viewsonic.com
South Africa	www.viewsoniceurope.com	www.viewsoniceurope.com/uk/Support/Calldesk.htm	
United Kingdom	www.viewsoniceurope.com/uk/	www.viewsoniceurope.com/uk/Support/Calldesk.htm	
United States	www.viewsonic.com	T (Toll-Free)= 1-800-688-6688 T (Toll)= 1-424-233-2530 F= 1-909-468-1202	service.us@viewsonic.com

Limited Warranty

VIEWSONIC® PROJECTOR

What the warranty covers:

ViewSonic warrants its products to be free from defects in material and workmanship, under normal use, during the warranty period. If a product proves to be defective in material or workmanship during the warranty period, ViewSonic will, at its sole option, repair or replace the product with a like product. Replacement product or parts may include remanufactured or refurbished parts or components.

Limited Three (3) year General Warranty

Subject to the more limited one (1) year warranty set out below, North and South America: Three (3) years warranty for all parts excluding the lamp, three (3) years for labor, and one (1) year for the original lamp from the date of the first consumer purchase; Europe except Poland: Three (3) years warranty for all parts excluding the lamp, three (3) years for labor, and ninety (90) days for the original lamp from the date of the first consumer purchase; Poland: Two (2) years warranty for all parts excluding the lamp, two (2) years for labor, and ninety (90) days for the original lamp from the date of the first consumer purchase.

Limited One (1) year Heavy Usage Warranty:

Under heavy usage settings, where a projector's use includes more than four (4) hours average daily usage, North and South America: One (1) year warranty for all parts excluding the lamp, one (1) year for labor, and ninety (90) days for the original lamp from the date of the first consumer purchase; Europe: One (1) year warranty for all parts excluding the lamp, one (1) year for labor, and ninety (90) days for the original lamp from the date of the first consumer purchase.

Other regions or countries: Please check with your local dealer or local ViewSonic office for the warranty information.

Lamp warranty subject to terms and conditions, verification and approval. Applies to manufacturer's installed lamp only. All accessory lamps purchased separately are warranted for 90 days.

Who the warranty protects:

This warranty is valid only for the first consumer purchaser.

What the warranty does not cover:

1. Any product on which the serial number has been defaced, modified or removed.
2. Damage, deterioration, failure, or malfunction resulting from:
 - a. Accident, abuse, misuse, neglect, fire, water, lightning, or other acts of nature, improper maintenance, unauthorized product modification, or failure to follow instructions supplied with the product.
 - b. Operation outside of product specifications.
 - c. Operation of the product for other than the normal intended use or not under normal conditions.
 - d. Repair or attempted repair by anyone not authorized by ViewSonic.
 - e. Any damage of the product due to shipment.
 - f. Removal or installation of the product.
 - g. Causes external to the product, such as electric power fluctuations or failure.
 - h. Use of supplies or parts not meeting ViewSonic's specifications.
 - i. Normal wear and tear.
 - j. Any other cause which does not relate to a product defect.
3. Removal, installation, and set-up service charges.

How to get service:

1. For information about receiving service under warranty, contact ViewSonic Customer Support (please refer to “Customer Support” page). You will need to provide your product’s serial number.
2. To obtain warranted service, you will be required to provide (a) the original dated sales slip, (b) your name, (c) your address, (d) a description of the problem, and (e) the serial number of the product.
3. Take or ship the product freight prepaid in the original container to an authorized ViewSonic service center or ViewSonic.
4. For additional information or the name of the nearest ViewSonic service center, contact ViewSonic.

Limitation of implied warranties:

There are no warranties, express or implied, which extend beyond the description contained herein including the implied warranty of merchantability and fitness for a particular purpose.

Exclusion of damages:

ViewSonic’s liability is limited to the cost of repair or replacement of the product. ViewSonic shall not be liable for:

1. Damage to other property caused by any defects in the product, damages based upon inconvenience, loss of use of the product, loss of time, loss of profits, loss of business opportunity, loss of goodwill, interference with business relationships, or other commercial loss, even if advised of the possibility of such damages.
2. Any other damages, whether incidental, consequential or otherwise.
3. Any claim against the customer by any other party.

Effect of state law:

This warranty gives you specific legal rights, and you may also have other rights which vary from state to state. Some states do not allow limitations on implied warranties and/or do not allow the exclusion of incidental or consequential damages, so the above limitations and exclusions may not apply to you.

Sales outside the U.S.A. and Canada:

For warranty information and service on ViewSonic products sold outside of the U.S.A. and Canada, contact ViewSonic or your local ViewSonic dealer.

The warranty period for this product in mainland China (Hong Kong, Macao and Taiwan Excluded) is subject to the terms and conditions of the Maintenance Guarantee Card.

For users in Europe and Russia, full details of warranty provided can be found in www.viewsoniceurope.com under Support/Warranty Information.

Mexico Limited Warranty

VIEWSONIC® PROJECTOR

What the warranty covers:

ViewSonic warrants its products to be free from defects in material and workmanship, under normal use, during the warranty period. If a product proves to be defective in material or workmanship during the warranty period, ViewSonic will, at its sole option, repair or replace the product with a like product. Replacement product or parts may include remanufactured or refurbished parts or components & accessories.

How long the warranty is effective:

3 years for all parts excluding the lamp, 3 years for labor, 1 year for the original lamp from the date of the first consumer purchase. Lamp warranty subject to terms and conditions, verification and approval. Applies to manufacturer's installed lamp only. All accessory lamps purchased separately are warranted for 90 days.

Who the warranty protects:

This warranty is valid only for the first consumer purchaser.

What the warranty does not cover:

1. Any product on which the serial number has been defaced, modified or removed.
2. Damage, deterioration or malfunction resulting from:
 - a. Accident, misuse, neglect, fire, water, lightning, or other acts of nature, unauthorized product modification, unauthorized attempted repair, or failure to follow instructions supplied with the product.
 - b. Any damage of the product due to shipment.
 - c. Causes external to the product, such as electrical power fluctuations or failure.
 - d. Use of supplies or parts not meeting ViewSonic's specifications.
 - e. Normal wear and tear.
 - f. Any other cause which does not relate to a product defect.
3. Any product exhibiting a condition commonly known as "image burn-in" which results when a static image is displayed on the product for an extended period of time.
4. Removal, installation, insurance, and set-up service charges.

How to get service:

For information about receiving service under warranty, contact ViewSonic Customer Support (Please refer to the attached Customer Support page). You will need to provide your product's serial number, so please record the product information in the space provided below on your purchase for your future use. Please retain your receipt of proof of purchase to support your warranty claim.

For Your Records

Product Name: _____

Model Number: _____

Document Number: _____

Serial Number: _____

Purchase Date: _____

Extended Warranty Purchase? _____ (Y/N)

If so, what date does warranty expire? _____

1. To obtain warranty service, you will be required to provide (a) the original dated sales slip, (b) your name, (c) your address, (d) a description of the problem, and (e) the serial number of the product.
2. Take or ship the product in the original container packaging to an authorized ViewSonic service center.
3. Round trip transportation costs for in-warranty products will be paid by ViewSonic.

Limitation of implied warranties:

There are no warranties, express or implied, which extend beyond the description contained herein including the implied warranty of merchantability and fitness for a particular purpose.

Exclusion of damages:

ViewSonic's liability is limited to the cost of repair or replacement of the product. ViewSonic shall not be liable for:

1. Damage to other property caused by any defects in the product, damages based upon inconvenience, loss of use of the product, loss of time, loss of profits, loss of business opportunity, loss of goodwill, interference with business relationships, or other commercial loss, even if advised of the possibility of such damages.
2. Any other damages, whether incidental, consequential or otherwise.
3. Any claim against the customer by any other party.
4. Repair or attempted repair by anyone not authorized by ViewSonic.

Contact Information for Sales & Authorized Service (Centro Autorizado de Servicio) within Mexico:**Name, address, of manufacturer and importers:**

México, Av. de la Palma #8 Piso 2 Despacho 203, Corporativo Interpalmas,
Col. San Fernando Huixquilucan, Estado de México
Tel: (55) 3605-1099
<http://www.viewsonic.com/la/soporte/index.htm>

NÚMERO GRATIS DE ASISTENCIA TÉCNICA PARA TODO MÉXICO: 001.866.823.2004**Hermosillo:**

Distribuciones y Servicios Computacionales SA de CV.
Calle Juarez 284 local 2
Col. Bugambilias C.P: 83140
Tel: 01-66-22-14-9005
E-Mail: disc2@hmo.megared.net.mx

Villahermosa:

Compumantenimientos Garantizados, S.A. de C.V.
AV. GREGORIO MENDEZ #1504
COL, FLORIDA C.P. 86040
Tel: 01 (993) 3 52 00 47 / 3522074 / 3 52 20 09
E-Mail: compumantenimientos@prodigy.net.mx

Puebla, Pue. (Matriz):

RENTA Y DATOS, S.A. DE C.V. Domicilio:
29 SUR 721 COL. LA PAZ
72160 PUEBLA, PUE.
Tel: 01(52).222.891.55.77 CON 10 LINEAS
E-Mail: datos@puebla.megared.net.mx

Veracruz, Ver.:

CONEXION Y DESARROLLO, S.A DE C.V. Av. Americas #
419
ENTRE PINZÓN Y ALVARADO
Fracc. Reforma C.P. 91919
Tel: 01-22-91-00-31-67
E-Mail: gacosta@qplus.com.mx

Chihuahua

Soluciones Globales en Computación
C. Magisterio # 3321 Col. Magisterial
Chihuahua, Chih.
Tel: 4136954
E-Mail: Cefeo@soluglobales.com

Cuernavaca

Compusupport de Cuernavaca SA de CV
Francisco Leyva # 178 Col. Miguel Hidalgo
C.P. 62040, Cuernavaca Morelos
Tel: 01 777 3180579 / 01 777 3124014
E-Mail: aquevedo@compusupporteva.com

Distrito Federal:

QPLUS, S.A. de C.V.
Av. Coyoacán 931
Col. Del Valle 03100, México, D.F.
Tel: 01(52)55-50-00-27-35
E-Mail : gacosta@qplus.com.mx

Guadalajara, Jal.:

SERVICRECE, S.A. de C.V.
Av. Niños Héroes # 2281
Col. Arcos Sur, Sector Juárez
44170, Guadalajara, Jalisco
Tel: 01(52)33-36-15-15-43
E-Mail: mmiranda@servicrece.com

Guerrero Acapulco

GS Computación (Grupo Sesicomp)
Progreso #6-A, Colo Centro
39300 Acapulco, Guerrero
Tel: 744-48-32627

Monterrey:

Global Product Services
Mar Caribe # 1987, Esquina con Golfo Pérsico
Fracc. Bernardo Reyes, CP 64280
Monterrey N.L. México
Tel: 8129-5103
E-Mail: aydem@gps1.com.mx

MÉRIDA:

ELECTROSER
Av Reforma No. 403Gx39 y 41
Mérida, Yucatán, México CP97000
Tel: (52) 999-925-1916
E-Mail: rrrb@sureste.com

Oaxaca, Oax.:

CENTRO DE DISTRIBUCION Y
SERVICIO, S.A. de C.V.
Murguía # 708 P.A., Col. Centro, 68000, Oaxaca
Tel: 01(52)95-15-15-22-22
Fax: 01(52)95-15-13-67-00
E-Mail: gpotai2001@hotmail.com

Tijuana:

STD
Av Ferrocarril Sonora #3780 L-C
Col 20 de Noviembre
Tijuana, Mexico

FOR USA SUPPORT:

ViewSonic Corporation
381 Brea Canyon Road, Walnut, CA. 91789 USA
Tel: 800-688-6688 (English); 866-323-8056 (Spanish);
Fax: 1-800-685-7276
E-Mail: <http://www.viewsonic.com>



ViewSonic®