

EPSON





User's Guide

**Multimedia Projector
EMP-6100
EMP-6000**

projectisle
.com.au

Where Projectors Roam Free



Attention	Indicates procedures which may result in damage or injury if sufficient care is not taken.
	Indicates additional information and points which may be useful to know regarding a topic.
	Indicates a page where detailed information regarding a topic can be found.
	Indicates that an explanation of the underlined word or words in front of this symbol appears in the glossary of terms. See the "Glossary" section of the "Appendices".  p.68
Procedure	Indicates operating methods and the order of operations. The procedure indicated should be carried out in the order of the numbered steps.
[(Name)]	Indicates the name of the buttons on the remote control or the control panel. Example: [Esc] button
"(Menu Name)"	Indicates configuration menu items. Example: "Image" - "Brightness"

Projector Features	4
Part Names and Functions	5
Front/Top.....	5
Rear (EMP-6100)	6
Rear (EMP-6000).....	7
Control Panel	8
Remote Control	9
Base	10

Useful Functions

Changing the Projected Image	12
Automatically Detect Incoming Signals and Change the Projected Image (Source Search)	12
Changing Directly from the Remote Control	13
Functions for Enhancing Projection	14
Selecting the Projection Quality (Selecting Colour Mode)	14
Hiding the Image and Sound Temporarily (A/V Mute)	15
Freezing the Image (Freeze).....	15
Changing the Aspect Ratio (Resize)	16
Pointer Function (Pointer)	17
Enlarging Part of the Image (E-Zoom)	18
Adjusting Colour for Several Projectors (Multi-Screen Colour Adjustment)	19
Summary of Adjustment Procedure	19
Setting Screen ID	19
Image Correction Method.....	20
Security Functions	22
Managing Users (Password Protect)	22
Restricting Operation (Operation Lock).....	25
Anti-Theft Lock	26

Configuration Menu

Using the Configuration Menu	28
List of Functions	29
Image Menu	29
Signal Menu	30
Settings Menu	31
Extended Menu	33
Network Menu (EMP-6100 Only)	35
Info Menu (Display Only).....	38
Reset Menu.....	39

Troubleshooting

Using the Help	41
Problem Solving	42
Reading the Indicators.....	42
When the Indicators Provide No Help.....	45

Appendices

Installation Methods	53
Cleaning	54
Cleaning the Projector's Surface	54
Cleaning the Lens Cover Glass	54
Cleaning the Air Filter	54
Replacing Consumables	56
Replacing the Remote Control Batteries	56
Replacing the Lamp.....	57
Replacing the Air Filter	60
Saving a User's Logo	62
Screen Size and Distance	64
Connecting to External Equipment	65
Connecting to an External Monitor	65
Connecting to External Speakers (EMP-6100 Only)	65
Connecting a LAN Cable (EMP-6100 Only)	66
Optional Accessories and Consumables	67
Glossary	68
List of ESC/VP21 Commands	70
Command List.....	70
Cable Layouts.....	70
PJLink (EMP-6100 Only)	71
List of Supported Monitor Displays	72
Specifications	73
Appearance	76
Index	77

High reliability

■ A highly efficient air filter is installed

Decreases the amount of dust that enters the projector.

■ A message and an indicator inform you when it is time to replace the air filter

The projector detects when the air filter is becoming clogged up and alerts you with a message and an indicator to give you advanced notice that the filter will soon need cleaning or replacing (EMP-6100 only).  [p.44](#)

■ Easy to detach, instantly-removable filter

There is only one air filter and it can be removed and installed easily.

 [p.60](#)

Enhanced security functions

■ Password Protect to restrict and manage users

By setting a password you can restrict who can use the projector.  [p.22](#)

■ Operation Lock restricts button operation on the control panel

You can use this to prevent people changing projector settings without permission at events, in schools, and so on.  [p.25](#)

■ Equipped with various anti-theft devices

The projector is equipped with the following security devices.  [p.26](#)

- Security slot
- Security cable installation point
- Cable cover key installation hole

Control and monitor from a remote location by a LAN

■ Control and monitor from a computer using EMP Monitor (EMP-6100 only)

You can use the EMP Monitor software supplied with the projector to display and check the projector's status on a computer monitor and control it from a computer.  [EMP Monitor Operation Guide](#)

■ Mail notification function when problems occur

When problems occur in the projector a mail notification is sent to a nominated e-mail address to inform the recipient of the projector's status.

 [p.36](#)

Multi-screen colour adjustment allows you to adjust the colour of several projectors

When several projectors are lined up and projecting images, you can adjust the colour tone of each image with multi-screen colour adjustment.

 [p.19](#)

Easy to handle

■ Direct power On/Off

In places where power is managed centrally, such as in a conference room, the projector can be set to power on and off automatically when the power source to which the projector is connected is switched on or off.

■ No cool down delay

You can disconnect the projector's power cable without having to wait for the projector to cool down first.

■ High powered, 1.6 times zoom lens

The 1.6 times zoom allows for a wide range of installation positions to suit most room layouts, whether the projector is on a stand, a table, or ceiling mounted.

Front/Top

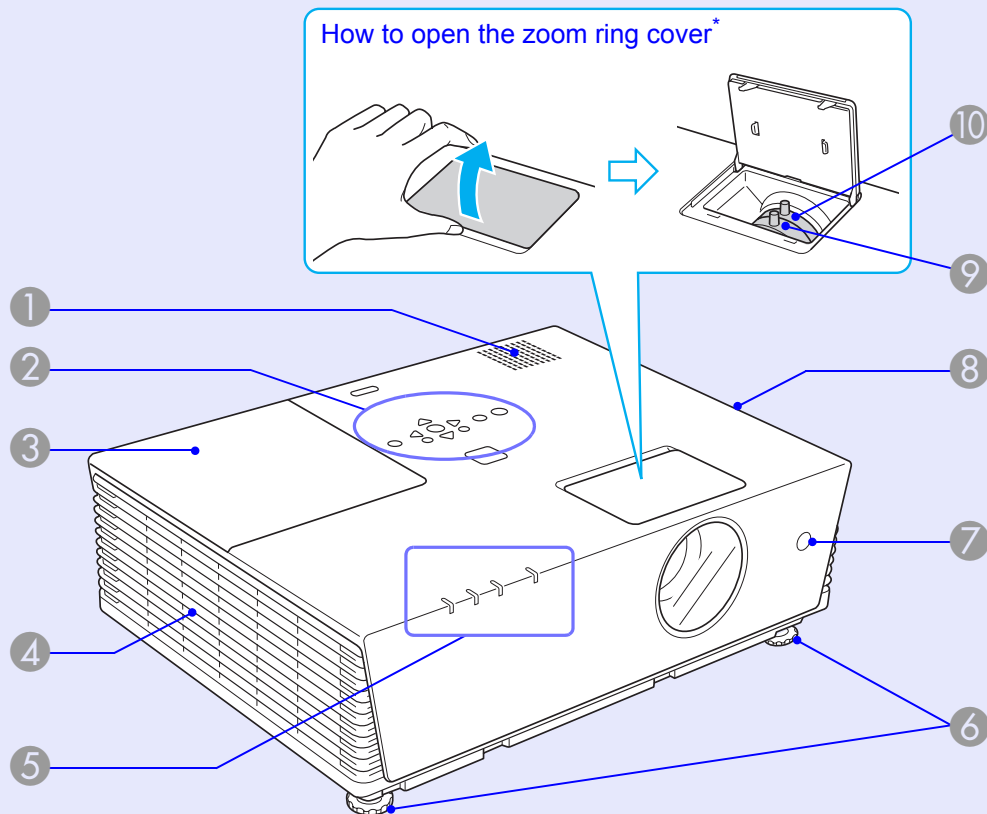

* Do not remove the zoom ring cover, and do not use the projector when it is open. Otherwise dust can enter into the projector and shorten the optical engine's service life.

Name	Function
1 Speaker	
2 Control panel	☞ p.8

Name	Function
3 Lamp cover	Open this cover when replacing the projector's lamp. ☞ p.57
4 Air exhaust vent	Attention Do not place objects that may become warped or otherwise affected by heat near the air exhaust vent and do not put your face or hands near the air exhaust vent while projection is in progress.
5 Status indicators	The colour of the indicators and whether they are flashing or lit indicates the status of the projector. ☞ p.42
6 Front adjustable feet	Turn to extend and adjust the position of the projected image when the projector is placed on a surface such as a desk. ☞ Quick Start Guide
7 Remote receiver	Receives signals from the remote control. ☞ Quick Start Guide
8 Air filter (Air intake vent)	This prevents dust and other foreign particles from getting inside the projector when air is drawn in. The projector displays a warning message when it is time to clean or replace the air filter. ☞ p.54, 60
9 Zoom ring	Adjusts the image size. ☞ Quick Start Guide
10 Focus ring	Adjusts the image focus. ☞ Quick Start Guide

Rear (EMP-6100)

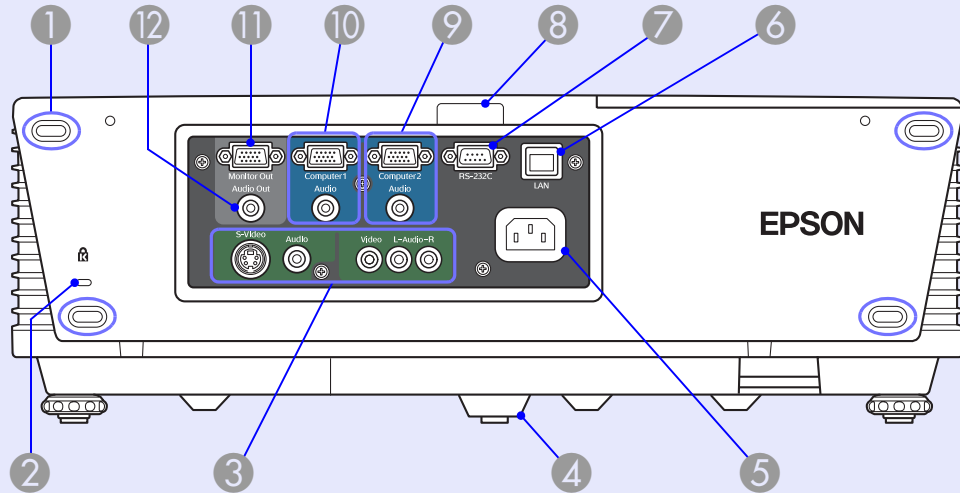

Name	Function
1 Storage feet	When storing the projector upright, make sure that these feet are at the bottom.
2 Security slot (🔒)	👉 p.26
3 S-Video port	For <u>S-video</u> signals from video sources.
Video port	For <u>composite video</u> signals from video sources.
Audio port L-Audio-R port	These connect to the audio out port of equipment that is connected to the S-Video or Video port. 👉 Quick Start Guide , p.31
4 Rear foot	
5 Power inlet	Connects to the power cable. 👉 Quick Start Guide

Name	Function
6 LAN port	When a LAN cable is connected, you can monitor and control the projector over a LAN. 👉 p.66
7 RS-232C port	When controlling the projector from a computer, connect it to the computer with an RS-232C cable. This port is for control use and should not normally be used. 👉 p.70
8 Remote receiver	Receives signals from the remote control. 👉 Quick Start Guide
9 Computer2 port	For video signals from a computer and <u>component video</u> signals from other video sources.
Audio port	Connect to the audio out port of the computer connected to the Computer2 port. 👉 Quick Start Guide
10 Computer1 port	For video signals from a computer and <u>component video</u> signals from other video sources.
Audio port	Connect to the audio out port of the computer connected to the Computer1 port. 👉 Quick Start Guide
11 Monitor Out port	Outputs the computer image signal connected to the Computer1 port to an external monitor. This is not available for <u>component video</u> signals or other signals being input to any port other than Computer1 port. 👉 p.65
12 Audio Out port	Outputs the sound of the image currently being projected to external speakers.

Rear (EMP-6000)

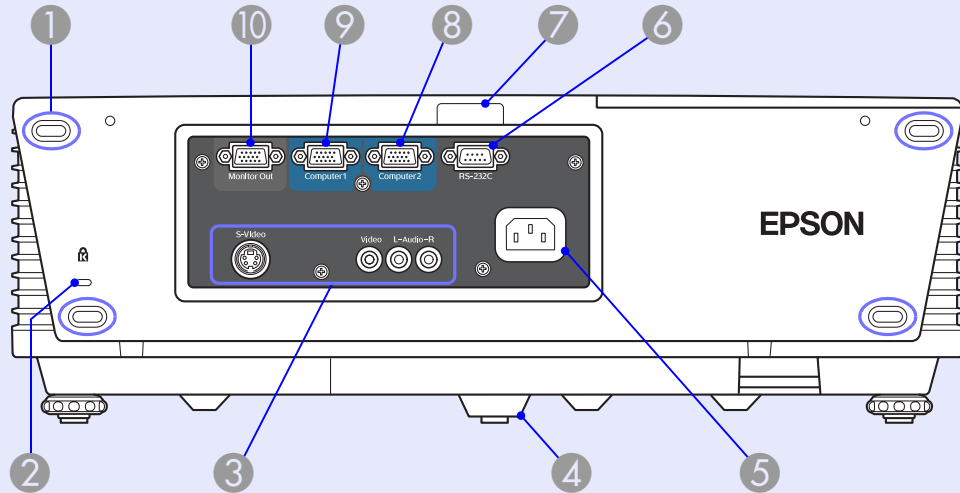







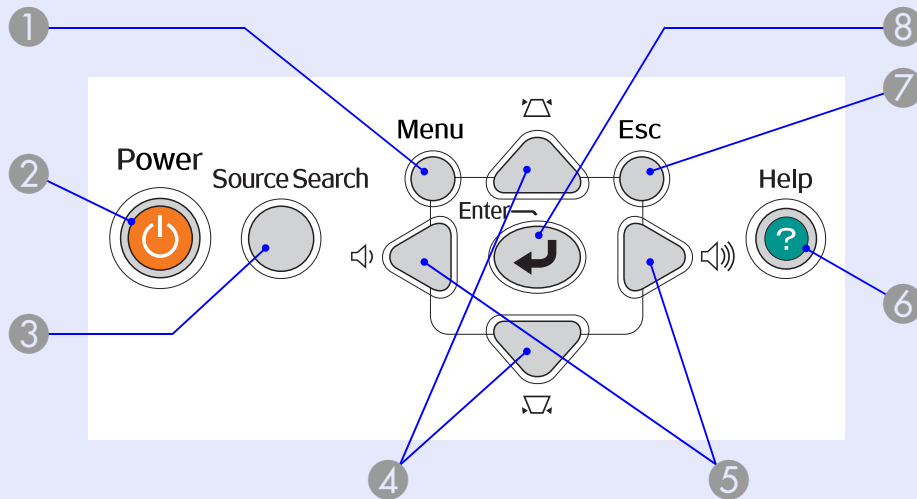

Name	Function
① Storage feet	When storing the projector upright, make sure that these feet are at the bottom.
② Security slot (🔒)	👉 p.26
③ S-Video port	For <u>S-video</u> signals from video sources.
Video port	For <u>composite video</u> signals from video sources.
L-Audio-R port	Connects to the audio out port of the equipment that is providing the image source to input the audio. 👉 Quick Start Guide
④ Rear foot	
⑤ Power inlet	Connects to the power cable. 👉 Quick Start Guide

Name	Function
⑥ RS-232C port	When controlling the projector from a computer, connect it to the computer with an RS-232C cable. This port is for control use and should not normally be used. 👉 p.70
⑦ Remote receiver	Receives signals from the remote control. 👉 Quick Start Guide
⑧ Computer2 port	For video signals from a computer and <u>component video</u> signals from other video sources. 👉 Quick Start Guide
⑨ Computer1 port	For video signals from a computer and <u>component video</u> signals from other video sources. 👉 Quick Start Guide
⑩ Monitor Out port	Outputs the computer image signal connected to the Computer1 port to an external monitor. This is not available for <u>component video</u> signals or other signals being input to any port other than Computer1 port. 👉 p.65

Control Panel









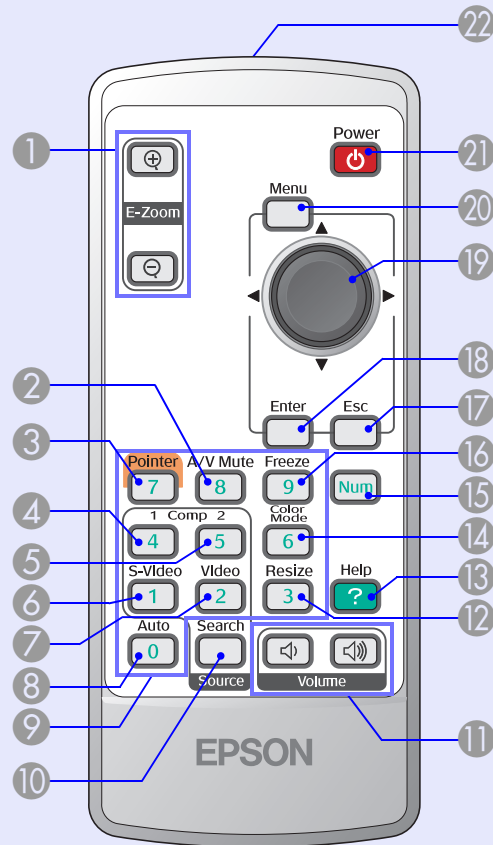









Name	Function
① [Menu] button	Displays and closes the configuration menu.  p.28
② [Power] button	Turns the projector power on or off.  Quick Start Guide
③ [Source Search] button	Changes to the next input source that is connected to the projector and is sending an image.  p.12
④ [△] [▽] buttons	Corrects keystone distortion. If pressed when a configuration menu or a help screen is displayed, these buttons select menu items and setting values.  Quick Start Guide, p.28









Name	Function
⑤ [◀] [▶] buttons	Adjusts the sound volume. If pressed when a configuration menu or a help screen is displayed, these buttons select menu items and setting values.  Quick Start Guide, p.28
⑥ [Help] button	Displays and closes the help screen which shows you how to deal with problems if they occur.  p.41
⑦ [Esc] button	Stops the current function. If pressed when a configuration menu is displayed, it moves to the previous menu level.  p.28
⑧ [Enter] button	If pressed during projection of computer signal images, it automatically adjusts the tracking, synchronization, and position to project the optimum image. When a configuration menu or a help screen is displayed, it accepts and enters the current selection and moves to the next level.  p.28

Remote Control





Name	Function
1 [E-Zoom] buttons (+) (-)	(+) Enlarges the image without changing the projection size. (-) Reduces parts of images that have been enlarged using the [+] button.  p.18
2 [A/V Mute] button	Turns the video and audio on or off.  p.15

Name	Function
3 [Pointer] button	Press to activate the on screen pointer.  p.17
4 [Comp1] button	Displays images from the Computer1 port.  p.13
5 [Comp2] button	Displays images from the Computer2 port.  p.13
6 [S-Video] button	Displays images from the S-Video port.  p.13
7 [Video] button	Displays images from the Video port.  p.13
8 [Auto] button	If pressed during projection of computer signal images, it automatically adjusts the tracking, synchronization, and position to project the optimum image.  p.30
9 Numeric buttons	Use these buttons when entering a password or screen ID.  p.24, 19
10 [Search] button	Changes to the next input source that is connected to the projector and is sending an image.  p.12
11 [Volume] buttons	() Decreases the volume. () Increases the volume.  Quick Start Guide
12 [Resize] button	The <u>aspect ratio</u>  changes each time the button is pressed.  p.16
13 [Help] button	Displays and closes the help screen which shows you how to deal with problems if they occur.  p.41
14 [Color Mode] button	Each time the button is pressed, the colour mode changes.  p.14

Name	Function
15 [Num] button	Use this button when entering a password or screen ID.  p.24, 19
16 [Freeze] button	Images are paused or unpaused.  p.15
17 [Esc] button	Stops the current function. If pressed when a configuration menu is displayed, it moves to the previous level.  p.28
18 [Enter] button	When a configuration menu or a help screen is displayed, it accepts and enters the current selection and moves to the next level.  p.28
19 [⊙] button	When a configuration menu or help screen is displayed, it selects menu items and setting values.  p.28
20 [Menu] button	Displays and closes the configuration menu.  p.28
21 [Power] button	Turns the projector power on or off.  Quick Start Guide
22 Remote control light-emitting area	Outputs remote control signals.  Quick Start Guide

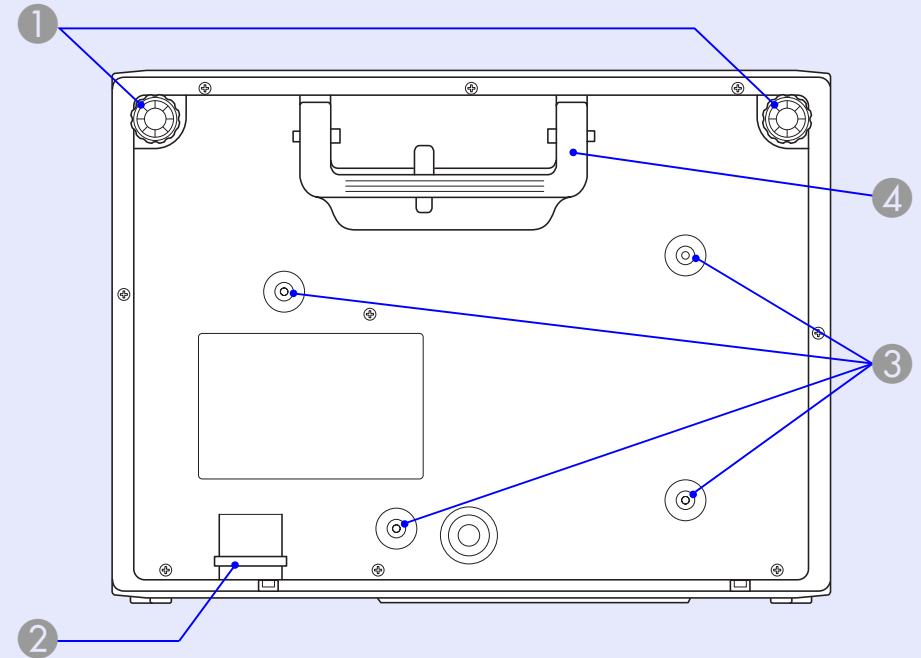
Base



Name	Function
1 Front adjustable feet	Turn to extend and adjust the position of the projected image when the projector is placed on a surface such as a desk.
2 Security cable installation point	Pass a commercially available anti-theft wire lock through here when you want to secure the projector to a fixed object.  p.26
3 Suspension bracket fixing points (4 points)	Attach the optional ceiling mount here when suspending the projector from a ceiling.  p.53, 67
4 Handle	Use this handle when carrying the projector.



Useful Functions

This chapter explains useful functions for giving presentations and so on, and the security functions.

Changing the Projected Image 12

- Automatically Detect Incoming Signals and Change the Projected Image (Source Search)12
- Changing Directly from the Remote Control13

Functions for Enhancing Projection 14

- Selecting the Projection Quality (Selecting Colour Mode)14
- Hiding the Image and Sound Temporarily (A/V Mute)15
- Freezing the Image (Freeze)15
- Changing the Aspect Ratio» (Resize)16
- Pointer Function (Pointer)17
- Enlarging Part of the Image (E-Zoom)18

Adjusting Colour for Several Projectors (Multi-Screen Colour Adjustment) 19

- Summary of Adjustment Procedure 19
- Setting Screen ID 19
- Image Correction Method 20

Security Functions 22

- Managing Users (Password Protect) 22
 - Type of Password Protect 22
 - Setting Password Protect 23
 - Entering the password 24
- Restricting Operation (Operation Lock) 25
- Anti-Theft Lock 26
 - Installing the wire lock 26
 - Cable cover locking method (EMP-6100 only) 26

You can change the projected image in the following two ways.

- Changing by Source Search
The projector automatically detects signals being input from connected equipment, and the image being input from the equipment is projected.
- Changing directly
You can use the remote control buttons to change to the target input port.

Automatically Detect Incoming Signals and Change the Projected Image (Source Search)

You can project the target image quickly as input ports with no image signal being input are ignored when you change by pressing the [Source Search] button.

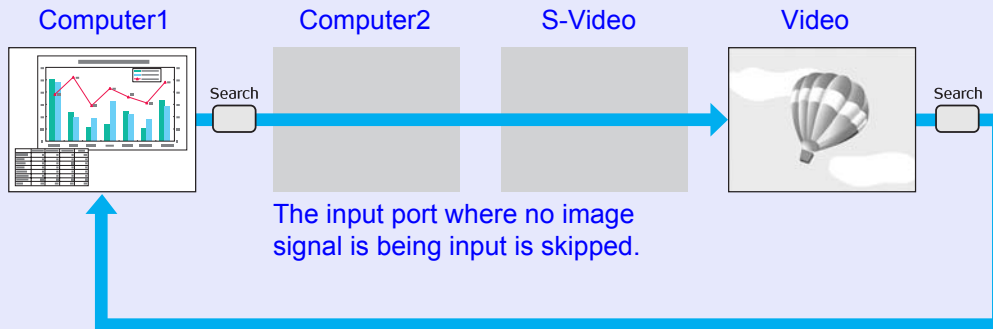

Procedure

When your video equipment is connected, start playback before beginning this operation.

Using the remote control

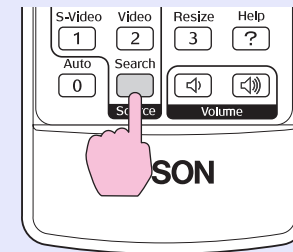

Using the control panel

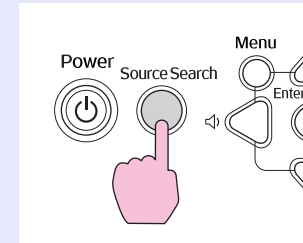

When two or more pieces of equipment are connected, press the [Source Search] button until the target image is projected.



The following screen showing the status of image signals is displayed when only the image that the projector is currently displaying is available, or when no image signal can be found. You can select the input port where the connected equipment you want to use is projecting. If no operation is performed after about 10 seconds, the screen closes.

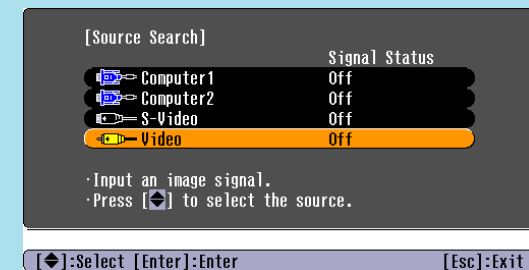

Changing Directly from the Remote Control

You can change directly to the target image by pressing the following buttons on the remote control.

Remote control

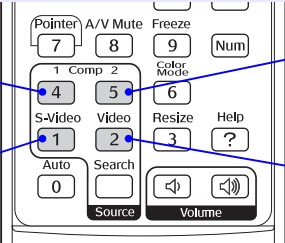

Changes to images from the Computer1 port.

Changes to images from the Computer2 port.

Changes to images from the S-Video port.

Changes to images from the Video port.

Selecting the Projection Quality (Selecting Colour Mode)

You can easily obtain the optimum image quality simply by selecting the setting that best corresponds to your surroundings when projecting. The brightness of the image varies depending on the mode selected.

Mode	Application
Photo	(When computer images are input) Ideal for projecting still pictures, such as photos, in a bright room. The images are vivid and brought into contrast.
Sports	(When component video, S-video, or composite video images are input) Ideal for watching TV programmes in a bright room. The images are vivid and brought to life.
Presentation	Ideal for giving presentations in a bright room.
Theatre	Ideal for watching films in a dark room. Gives images a natural tone.
Game	Ideal for playing video games in a bright room. Excels at emphasizing dark gradations.
<u>sRGB</u> ▶▶	Ideal for images that conform to the sRGB colour standard.
Blackboard	Even if you are projecting onto a blackboard (greenboard), this setting gives your images a natural tint, just like when projecting onto a screen.

Procedure

Remote control

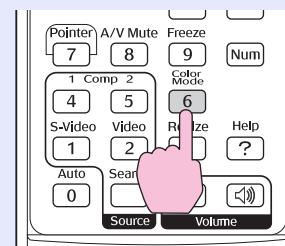

Each time you press the button, the colour mode name is displayed on the screen and the colour mode changes.

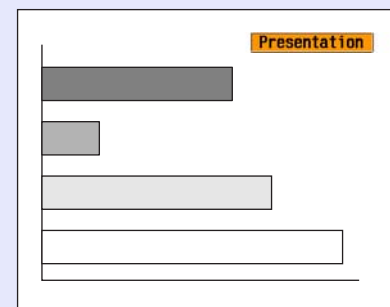

If you press the button while the colour mode name is displayed on the screen, it changes to the next colour mode.



The colour mode can also be set using "Color Mode" in the "Image" menu from the configuration menu. [p.29](#)

Hiding the Image and Sound Temporarily (A/V Mute)

You can use this when you want to focus the audience's attention on what you are saying, or if you do not want to show details such as when you are changing between files during presentations from a computer.

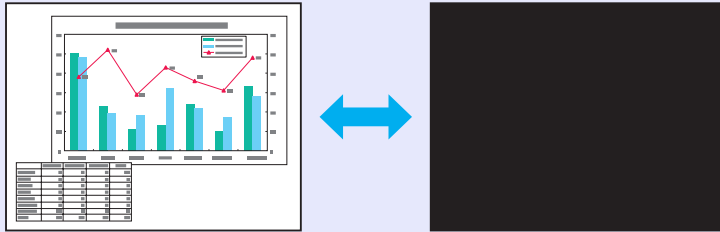

Procedure

Remote control

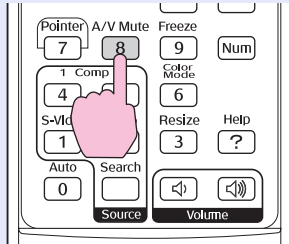

Each time you press the button, A/V Mute turns on or off.



- If you use this function when projecting moving images, the images and sound continue to be played back by the source, and you cannot return to the point where A/V Mute was activated.
- You can choose to display black, blue, or logo as the A/V Mute display using the "Extended"- "Display"- "A/V Mute" setting from the configuration menu. p.33

Freezing the Image (Freeze)

When the moving image on the screen is frozen, the image continues to project, so you can project a moving image one frame at a time like a still photo. Also, you can perform operations such as changing between files during presentations from a computer without projecting any images if the freeze function is activated beforehand.

Procedure

Remote control

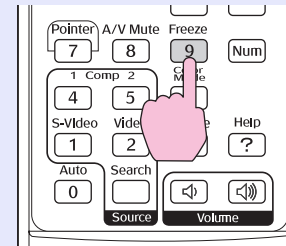

Each time you press the button, Freeze turns on or off.



- **Audio does not stop.**
- **The image source continues to playback the moving images even while the screen is frozen, and so it is not possible to resume projection from the point where it was paused.**
- **If the [Freeze] button is pressed while the configuration menu or a help screen is displayed, the menu or help screen being displayed is cleared.**
- **Freeze still works while E-Zoom is being used.**

Changing the Aspect Ratio» (Resize)

When video equipment is connected, images that have been recorded in digital video or onto DVDs can be viewed in 16:9 wide-screen format. You can change the aspect ratio for images in squeeze mode» as follows.

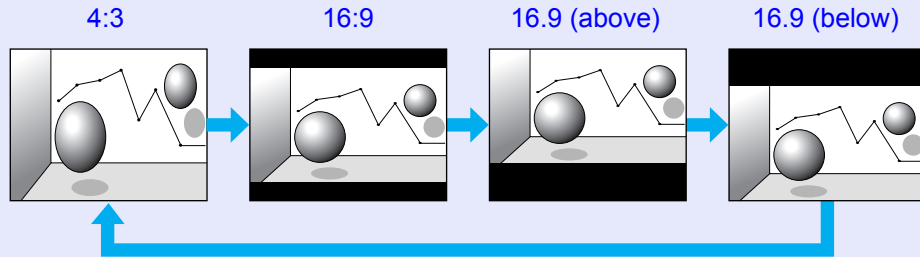

Procedure

Remote control

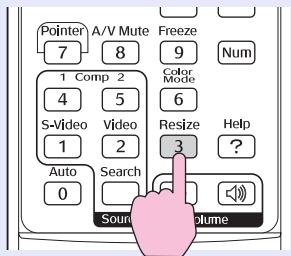

Each time you press the button, the aspect name is displayed on the screen and the aspect changes.

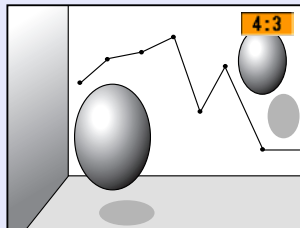

If you press the button while the aspect name is displayed on the screen, it changes to the next aspect mode.



The colour mode can also be set using "Resize" in the "Signal" menu from the configuration menu. 📖 p.30

Pointer Function (Pointer)

This allows you to move a pointer icon on the projected image, and helps you draw attention to the area you are talking about.

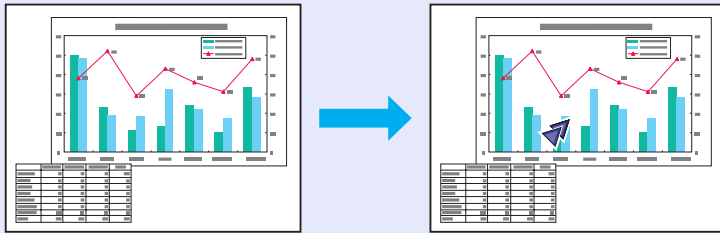

Procedure

1 Display the pointer.

Remote control

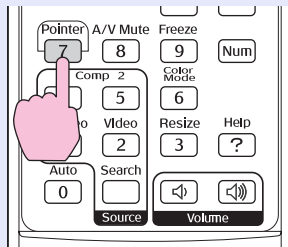

Each time you press the button, the pointer appears or disappears.

2 Move the pointer icon.

Remote control

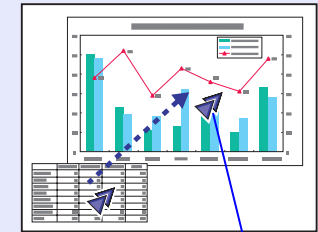
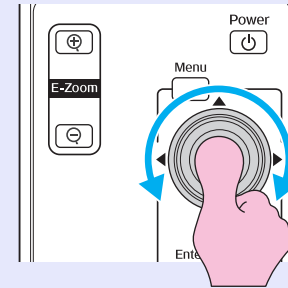

Pointer icon



You can choose from three different kinds of pointer icon (➤, ✖, ➤) in "Pointer Shape" in the "Settings" menu from the configuration menu. [p.31](#)

Enlarging Part of the Image (E-Zoom)

This is useful when you want to expand images to see them in greater detail, such as graphs and tables.

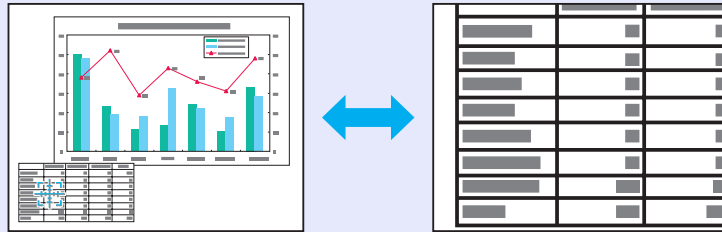

Procedure

1 Start E-Zoom.

Remote control

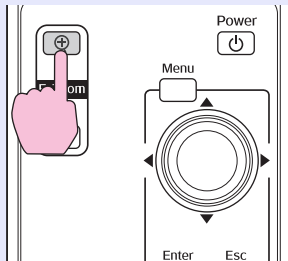

2 Move the cross to the area of the image that you want to enlarge.

Remote control

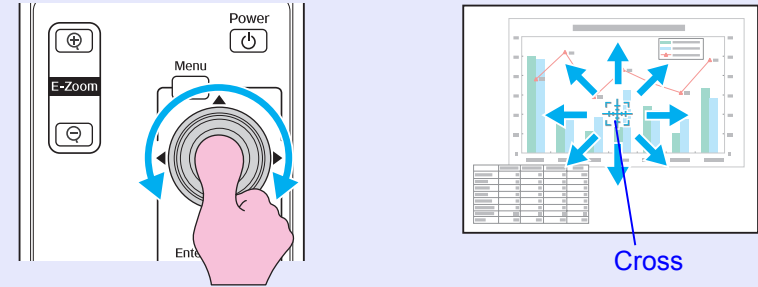

3 Enlarge.

Remote control

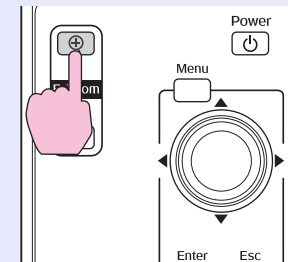

Each time the button is pressed, the area is expanded. You can expand quickly by holding the button down. You can reduce the enlarged image by pressing the [Q] button. Press the [Esc] button to cancel.



- *The enlargement ratio appears on the screen. The selected area can be enlarged to between 1 to 4 times in 25 incremental steps.*
- *Tilt the [D] button to scroll the image.*

When several projectors are lined up and projecting images, you can adjust the brightness and colour tone of each projector's image with multi-screen colour adjustment so that the colours of images from each projector match closely.

In some cases the brightness and colour tone may not match completely even after adjustment.

Summary of Adjustment Procedure

Make adjustments according to the following procedure.

1. Setting screen ID

Before setting up the projectors, set one screen ID for each.

When making adjustments for two or more projectors using the remote control, you can operate them individually by setting individual screen IDs for each projector.

2. Making image corrections

After the projectors are setup, you can adjust the image for each projector.

Using Image Correction you can adjust from black to white in five stages called levels 1 to 5, and in each level 1 to 5 you can adjust the following two points.

- Adjusting brightness
Adjust each image by levels 1 to 5 so that they are all equal.
- Adjusting colour
Adjust each image by levels 1 to 5 so that the colours match using "Color Correct. (G/R)" and "Color Correct. (B/Y)".

Setting Screen ID

For instance, after setting one projector as screen ID3, when you press button [3] while holding down the [Num] button, even if there is more than one projector setup, you can operate just the one set as screen ID3.

Procedure



Press the [Menu] button and select "Extended" - "Multi-screen" - "Screen ID" from the configuration menu. ➡ "Using the Configuration Menu" p.28

Using the remote control

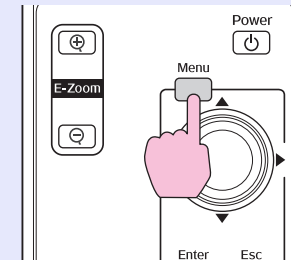

Using the control panel

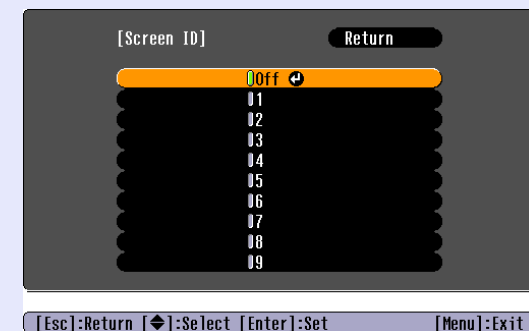
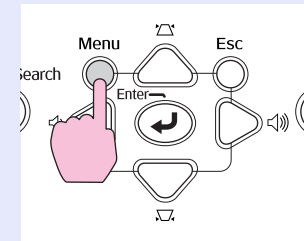

Check the buttons you can use and the operations they perform in the guide under the menu.

2 Choose the ID you want to set and press the [Enter] button.

3 Press the [Menu] button to close the configuration menu.

- Point the remote control at the remote receiver on the projector you want to operate, press the numeric button corresponding to the screen ID set while holding down the [Num] button, and then you can operate only the projector specified with the ID number.
- You can operate all projectors regardless of the screen ID settings by pointing the remote control at the remote receiver on the projector, and pressing the [0] button while holding down the [Num] button.



- *The screen IDs set here are only effective during "Image Correction" for "Multi-screen".*
- *If a projector that is not the object of operation reacts to the remote control, point the remote control at the remote receiver on that projector and press the number set as that projector's screen ID while holding down the [Num] button.*

Image Correction Method

After setting up the projectors, adjust the brightness and tone for each image.

Procedure

1 Press the [Menu] button and select "Extended" - "Multi-screen" - "Image Correction" from the configuration menu.  "Using the Configuration Menu" p.28

2 Select the level to be adjusted in "Adjustment Level".

- Each time a level is selected, the pattern of the level selected is displayed.
- You can start adjusting from any level, usually you can make it darker or lighter by adjusting 1 to 5 or 5 to 1.

3 Adjust the brightness with "Brightness Correct."

- When you select level 5, it adjusts to the darkest image from several projectors.
- When you select level 1, it adjusts to the brightest image from several projectors.
- When you select level 2 to 4, it adjusts to the mid-range brightness image from several projectors.
- Each time the [Enter] button is pressed the image displayed changes between the pattern display and the actual image, and you can check the adjustment results and make corrections in the actual image.

4 Adjusting "Color Correct. (G/R)" and "Color Correct. (B/Y)".

Each time the [Enter] button is pressed the image displayed changes between the pattern display and the actual image, and you can check the adjustment results and make corrections in the actual image.

5 Repeat procedures 2 to 4 until adjustments are finished.

6 When all adjustments are finished, press the [Menu] button to close the configuration menu.

The projector has the following enhanced security functions.

- **Password Protect**
You can limit who can use the projector.
- **Operation Lock**
You can prevent people changing the settings on the projector without permission.
- **Security Lock**
The projector is equipped with various types of anti-theft security devices.

Managing Users (Password Protect)

When Password Protect is activated, people who do not know the password cannot use the projector to project images even if the projector power is on. Furthermore, the user's logo that is displayed when you turn on the projector cannot be changed. This acts as an anti-theft device as the projector cannot be used even if it is stolen. At the time of purchase, Password Protect is not activated.

■ Type of Password Protect

The following four kinds of password protect settings can be made according to how the projector is being used.

1. "Power On Protect"

When "Power On Protect" is "On", the password must be entered whenever the projector is turned on after it has been disconnected from the power supply it was connected to the last time the password was entered.

If the correct password is not entered, projection does not start.

2. "Password Timer"

When "Password Timer" is set to "On" and a time limit is set, the projector requests the password after the time limit has passed.

3. "User's Logo Protect"

When "User's Logo Protect" is set to "On" the user's logo cannot be changed and the following setting changes for user's logo are prohibited.

- Capturing a user's logo
- Settings for "Display Background", "Startup Screen", and "A/V Mute" from "Display" on the configuration menu.

4. "Network Protect" (EMP-6100 only)

When "Network Protect" is set to "On" setting changes for "Network" in the configuration menu are prohibited.

■ Setting Password Protect

Use the following procedure to set Password Protect.

Procedure

1 Hold down the [Freeze] button for about five seconds.

The password protect setting menu is displayed.

Remote control

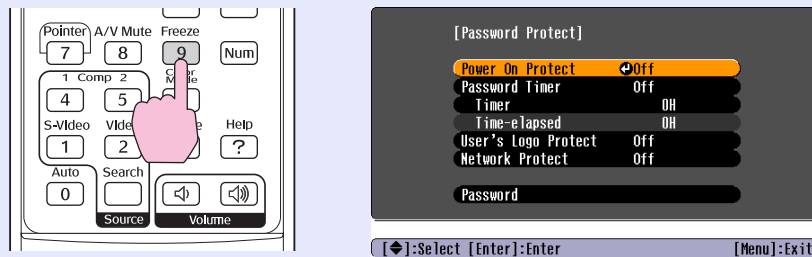

- *If Password Protect is already activated, you must enter the password.
If the password is entered correctly, the password protect setting menu is displayed. ➡ "Entering the password" p.24*
- *When the password is set, stick the password protect sticker in a visible position on the projector as a further theft deterrent (EMP-6100 only).*

2 Turn on "Power On Protect".

- (1) Select "Power On Protect", and then press the [Enter] button.
- (2) Select "On", and then press the [Enter] button.
- (3) Press the [Esc] button.

3

Turn on "Password Timer".

If you do not use this setting, go to step 4.

- (1) Select "Password Timer", and then press the [Enter] button.
- (2) Select "On", and then press the [Enter] button.
- (3) Press the [Esc] button.
- (4) Select "Timer", and then press the [Enter] button.
- (5) While holding down the [Num] button, use the numeric buttons to enter the setting time within a range of 1 to 9999 hours and then press the [Enter] button. If you make a mistake entering the time, press the [Esc] button and re-enter the time. The time counter begins when you close the password protect setting menu. The count is only done while the lamp is lit, and not while it is turned off.
The time already counted is displayed in "Time-elapsed".

4

Turn on "User's Logo Protect".

- (1) Select "User's Logo Protect", and then press the [Enter] button.
- (2) Select "On", and then press the [Enter] button.
- (3) Press the [Esc] button.

5

Turn on "Network Protect" (EMP-6100 only).

- (1) Select "Network Protect", and then press the [Enter] button.
- (2) Select "On", and then press the [Enter] button.
- (3) Press the [Esc] button.

6

Set the password.

- (1) Select "Password", and then press the [Enter] button.
- (2) The message "Change the password?" is displayed, select "Yes" and then press the [Enter] button. The default setting for the password is "0000". Change this to your own desired password. If you select "No", the screen shown in step 1 is displayed again.
- (3) While holding down the [Num] button, enter a four digit number using the numeric buttons. The number entered is displayed as "****". When you enter the fourth digit, the confirmation screen is displayed.

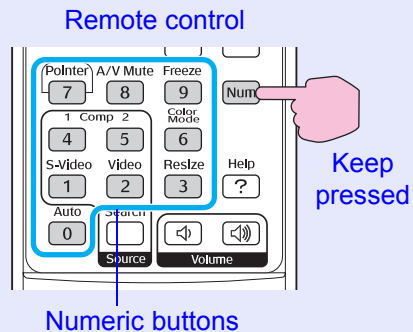

- (4) Re-enter the password.
The message "Password accepted." is displayed.
If you enter the password incorrectly, a message is displayed prompting you to re-enter the password.

Entering the password

When the password entry screen is displayed, enter the password using the numeric buttons on the remote control.

Procedure

While holding down the [Num] button, enter the password by pressing the numeric buttons.

When you enter the correct password, projection begins.

Attention

- *If an incorrect password is entered three times in succession, the message "The projector's operation will be locked." is displayed for about five minutes, and then the projector switches to standby mode. If this happens, disconnect the power plug from the electrical outlet and then reinsert it and turn the projector's power back on. The projector displays the password entry screen again so that you can enter the correct password.*
- *If you have forgotten the password, make a note of the "Request Code: xxxxx" number that appears on the screen and contact the nearest address provided in the World-Wide Warranty Terms.*
👉 *Inquiries*
- *If you continue to repeat the above operation and input the wrong password thirty times in succession, the following message is displayed and the projector does not accept any more password entries. "The projector's operation will be locked. Contact Epson as described in your documentation."* 👉 *Inquiries*

Restricting Operation (Operation Lock)

Do one of the following to lock the operation buttons on the control panel.

- Full lock
All of the buttons on the control panel are locked. You cannot perform any operations from the control panel, including turning the power on or off.
- Partial lock
All of the buttons on the control panel, except for the [Power] button, are locked.

This is useful at events or shows when you want to deactivate all buttons and only project, or at schools when you want to limit button operation. The projector can still be operated using the remote control.

Procedure

- 1 Press the [Menu] button and select "Settings" - "Operation Lock". "Using the Configuration Menu" p.28

Using the remote control

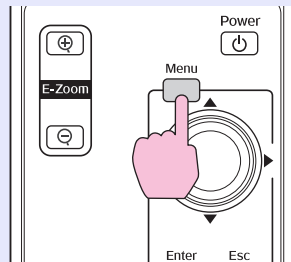

Using the control panel

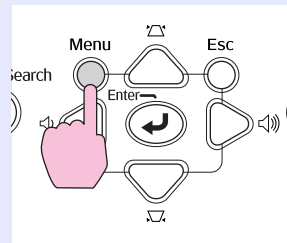

Check the buttons you can use and the operations they perform in the guide under the menu.

- 2 Select either "Full Lock" or "Partial Lock".

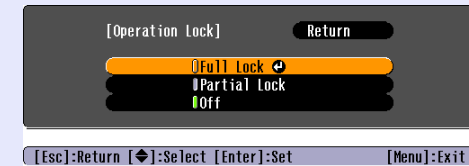

- 3 Select "Yes" when the confirmation message is displayed.

The control panel buttons are locked according to the setting you chose.



You can release the control panel lock by one of the following two methods.

- From the remote control, select "Off" in "Settings"- "Operation Lock" from the configuration menu.
- Press and hold down the [Enter] button on the control panel for about seven seconds, a message is displayed and the lock is released.

Anti-Theft Lock

As the projector is often setup on ceiling mounts and left in rooms unattended, it is possible that someone may try and take the projector, so the projector includes the following security devices.

- **Security slot**

The security slot is compatible with the Microsaver Security System manufactured by Kensington. You can find details about the Microsaver Security System on the Kensington homepage <http://www.kensington.com/>.

- **Security cable installation point**

A commercially available theft-prevention wire lock can be passed through the installation point to secure the projector to a desk or pillar.

- **Cable cover padlock hole (EMP-6100 only)**

Lock the cable cover using a commercially available padlock, because the power cable and connection cables cannot be unplugged from the projector once the cable cover is locked, the projector cannot easily be removed.

- **Installing the wire lock**

Pass an anti-theft wire lock through the installation point. See the documentation supplied with the wire lock for locking instructions.

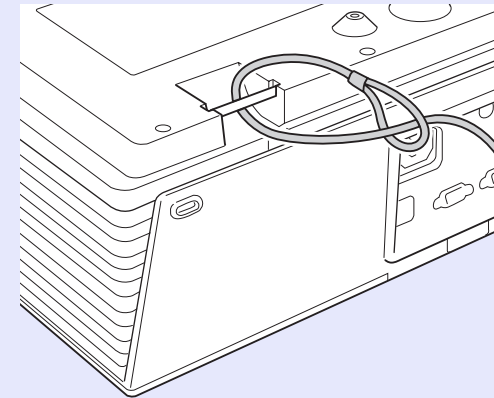

- **Cable cover locking method (EMP-6100 only)**

After fitting the cable cover, lock it using a commercially available padlock.

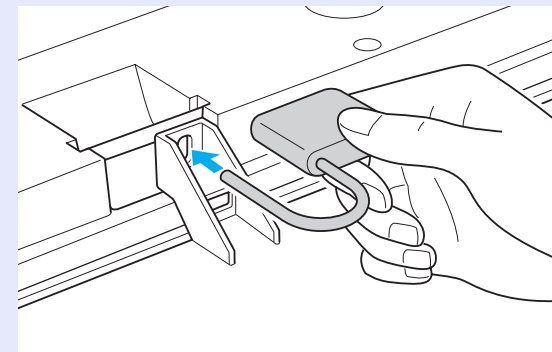



Configuration Menu

This chapter explains how to use the configuration menu and its functions.

Using the Configuration Menu	28
List of Functions	29
• Image Menu	29
• Signal Menu	30
• Settings Menu	31
• Extended Menu	33
• Network Menu (EMP-6100 Only)	35
• Info Menu (Display Only).....	38
• Reset Menu	39

1 Selecting from the top menu

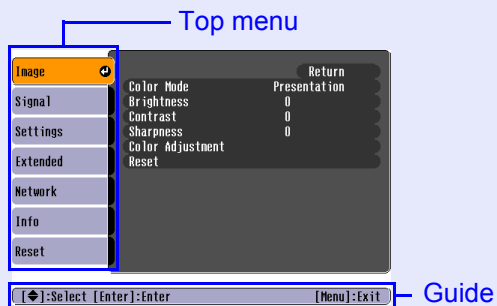

2 Selecting from the sub menu

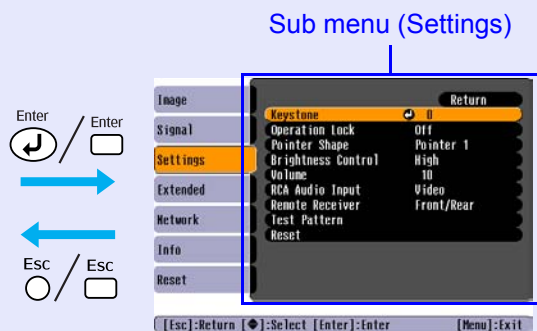

3 Changing the selected item

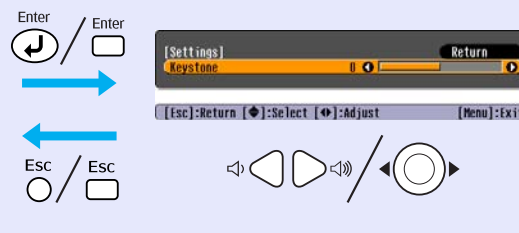

4 Exit

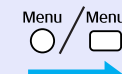
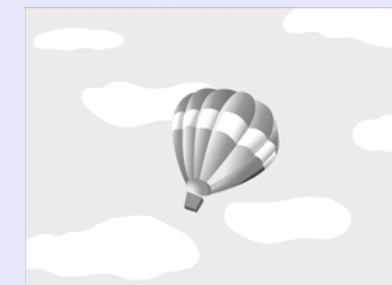

Select the setting to change

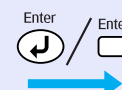

Buttons used

Using the control panel

Using the remote control

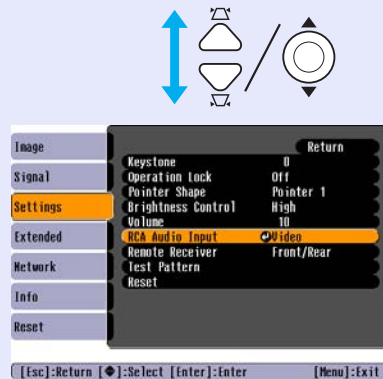
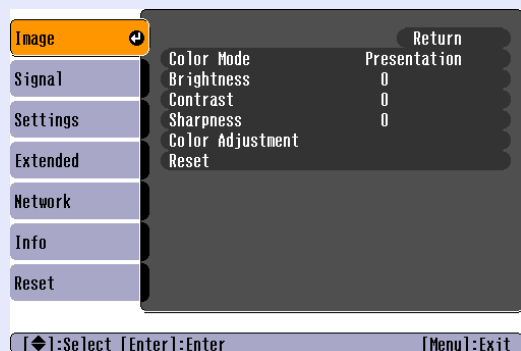

Image Menu



Items that can be set vary depending on the image signal currently being projected as shown in the following screen shots. Setting details are saved for each image signal.

Computer image



Component video▶▶/Composite video▶▶/S-video▶▶



Sub Menu	Function
Color Mode	You can select the quality of the image to suit your surroundings.  p.14
Brightness	You can adjust the image brightness.
<u>Contrast</u> ▶▶	You can adjust the difference between light and shade in the images.
Color Saturation	You can adjust the colour saturation for the images.
Tint	(Adjustment is only possible when NTSC signals are being input if you use composite video/S-video.) You can adjust the image tint.
Sharpness	You can adjust the image sharpness.
Color Adjustment	You can make adjustments by choosing one of the following. Abs. Color Temp.: You can adjust the overall tint of images. You can adjust tints in 10 stages from 5000 K to 10000 K. When a high value is selected the image becomes tinged with blue, when a low value is selected the image becomes tinged with red. Red, Green, Blue: You can adjust the saturation of each colour individually. (This item cannot be selected if " <u>sRGB</u> ▶▶" is selected as the "Color Mode" setting in the "Image" menu.)
Reset	You can reset all adjustment values for the "Image" menu functions to their default settings. To return all menu items to their default settings, see  p.39

Signal Menu

Items that can be set vary depending on the image signal currently being projected as shown in the following screen shots. Setting details are saved for each image signal.

Computer image

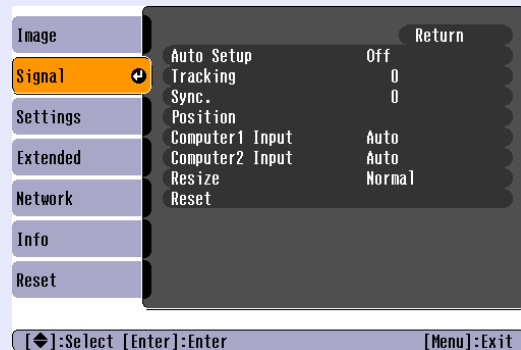



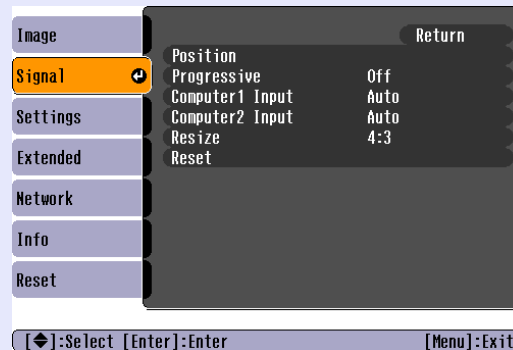

Component video

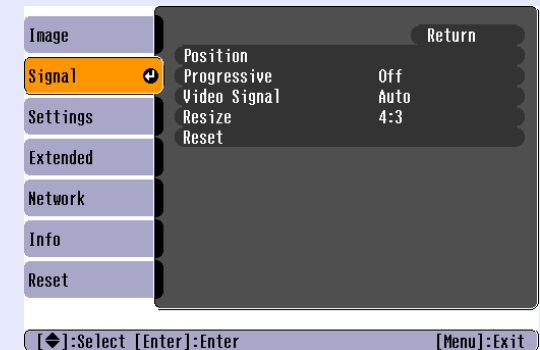







Composite video/S-video

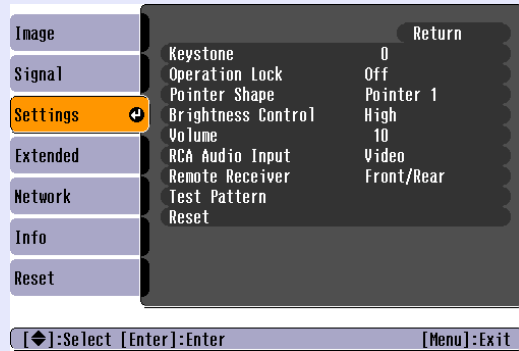

Sub Menu	Function
Auto Setup	You can select whether, when the input signal changes, the image is automatically adjusted to the optimum state (On) or not (Off).  p.48
Tracking	You can adjust computer images when vertical stripes appear in the images.  p.48
Sync.	You can adjust computer images when flickering, fuzziness, or interference appears in the images.  p.48
Position	You can adjust the display position up, down, left, and right when a part of the image is missing so that all of the image is projected.
Progressive	(Component video can only be adjusted when 525i/625i signals are being input) Off: IP conversion is carried out for each field in the screen. This is ideal for viewing images with a large amount of movement. On: <u>interlace</u> (i) signals are converted into <u>progressive</u> (p) signals. This is ideal for viewing still images.
Computer1 Input	You can select the input signal from Computer1 port or Computer2 port.
Computer2 Input	If set to "Auto" the input signal is set automatically according to the connected equipment. If colours do not appear correctly when set to "Auto", select the appropriate signal according to the connected equipment.
Video Signal	If set to "Auto", video signals are recognized automatically. If interference appears in the image or a problem occurs such as no image is being projected when set to "Auto", select the appropriate signal according to the connected equipment.
Resize	You can set the <u>aspect ratio</u> for projected images.  p.16
Reset	You can reset all adjustment values on the "Signal" menu to their default settings, except for "Computer1 Input" and "Computer2 Input". To return all menu items to their default settings, see  p.39

Settings Menu



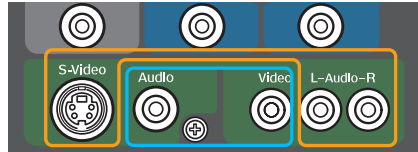

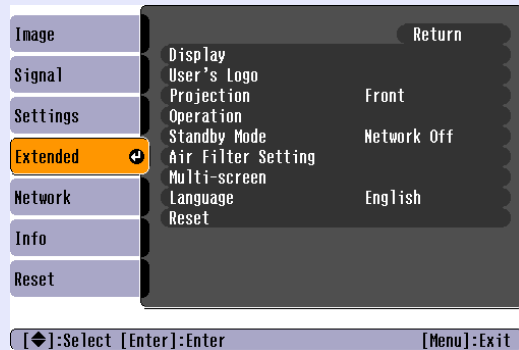

Sub Menu	Function	
Keystone	You can correct vertical keystone distortion in images.  Quick Start Guide	
Operation Lock	You can use this to restrict operation of the projector's control panel.  p.25	
Pointer Shape	You can select the shape of the pointer.  p.17 Pointer 1:  Pointer 2:  Pointer 3: 	
Brightness Control	You can set the lamp brightness to one of two settings. Select "Low" if the images being projected are too bright such as when projecting images in a dark room or onto a small screen. When "Low" is selected, the amount of electricity consumed is changed as follows, and fan rotation noise during projection is reduced. Electrical consumption: about a 46 W decrease	
Volume	You can adjust the volume.	
RCA Audio Input (EMP-6100 only)	You can select whether to use the RCA audio port (L-Audio-R) as audio input for either the equipment connected to the Video port or the equipment connected to the S-Video port. For example, the illustration on the right shows how the image port and the audio port are combined when "S-Video" is selected.	<p>When you select "S-Video"</p> 
Remote Receiver	You can limit the reception of the operation signal from the remote control. When you want to prohibit operation by remote control, or if the remote receiver has a fluorescent light too close to it, you can make settings to deactivate the remote receiver you do not want used or that is experiencing interference.	

Sub Menu	Function
Test Pattern	When the projector is setup, a test pattern is displayed so that you can adjust the projection without connecting other equipment. While displaying the test pattern, you can perform Zoom, Focus, and Keystone adjustments. To cancel the test pattern, press the [Esc] button on the remote control or the control panel.
Reset	You can reset all adjustment values for the "Settings" menu, except for "RCA Audio Input (EMP-6100 only)", to their default settings. To return all menu items to their default settings, see  p.39

Extended Menu



Sub Menu	Function
Display	<p>You can make settings related to the projector's display.</p> <p>Messages: You can set whether to display (On) or not display (Off) the source name when you change the input source, the colour mode name when you change the colour mode, a message when no image signal is input, and so on.</p> <p>Display Background*1: You can set the screen status for when no image signal is available to "Black", "Blue", or "Logo".</p> <p>Startup Screen*1: You can set if the startup screen (the image projected when starting the projector) is displayed or not.</p> <p>A/V Mute*1: You can set the screen displayed during A/V Mute as "Black", "Blue", or "Logo".</p>
User's Logo*1	You can change the user's logo that is displayed as a background and displayed during A/V Mute.  p.62
Projection	<p>You can set from the following according to the way the projector is setup.  p.53</p> <p>"Front" "Front/Ceiling" "Rear" "Rear/Ceiling"</p> <p>You can change the setting as follows by pressing down the [A/V Mute] button on the remote control for about five seconds.</p> <p>"Front" ↔ "Front/Ceiling"</p> <p>"Rear" ↔ "Rear/Ceiling"</p>
Operation	<p>Direct Power On: You can set whether Direct Power On is enabled (On) or disabled (Off).</p> <p>When it is set to "On" and the projector power cable is connected to an electrical outlet, be aware that sudden surges of electricity when power comes back on after a power outage may cause the projector to turn on automatically.</p> <p>Sleep Mode: You can set whether projection stops automatically (On) or not (Off) when no operations are carried out for about 30 minutes while no image signals are being input.</p> <p>High Altitude Mode: Set to "On" when using the projector above an altitude of 1500 m.</p>
Standby Mode	<p>You can use network monitoring and control functions while the projector is in standby mode when this is set to "Network On".</p> <p>Depending on the model, you can use the following methods to monitor and control the state of the projector.</p> <p>EMP-6100: You can use SNMP or EMP Monitor software supplied with this product.</p> <p>EMP-6000: You can download the EMP Monitor software*2 from the your local Epson homepage.</p>

Sub Menu	Function
Air Filter Setting	<p>You can set information regarding the replacement time for the air filter.</p> <p>Alarm Timer: You can set whether you are informed (On) or not (Off) when it is time to replace the air filter. Make sure you set this to "On" if you are using the smoke type air filter.</p> <p>Timer: You can set whether or not to display a message indicating length of use. The projector automatically detects the type of air filter installed and sets the appropriate time for filter replacement. However, you can set the message to warn you earlier depending on the projector's environment to give you more notice that maintenance will soon be required.</p>
Multi-screen	<p>You can adjust the hue and brightness of each projected image when multiple projectors are lined up and projecting.  p.19</p> <p>Screen ID: When performing "Image Correction" for "Multi-screen" by using one remote control for multiple projector's, you can define which projector to use when individual IDs are set. The IDs set here are only effective during "Image Correction" for "Multi-screen".</p> <p>Image Correction: You can make the following adjustments.</p> <p>Adjustment Level: You can adjust from black to white in five stages called levels 1 to 5, and in each level 1 to 5 you can adjust "Brightness Correct." and "Color Correct."</p> <p>Brightness Correct.: Corrects the difference in the brightness of each product.</p> <p>Color Correct. (G/R) / Color Correct. (B/Y) :Corrects the difference in the colour of each product.</p>
Language	<p>You can set the language for message displays.</p>
Reset	<p>You can reset "Display^{*1}", "Operation^{*3}", and "Air Filter Setting" in the "Extended" menu to their default settings. To return all menu items to their default settings, see  p.39</p>

*1 When "User's Logo Protect" is set to "On" in "Password Protect", settings relating to user's logo cannot be changed. You can make changes after setting "User's Logo Protect" to "Off".  [p.23](#)

*2 To download EMP Monitor software, go to <http://www.epson.com>, select your local Epson Web site and then select the support section. EMP Monitor is software that uses a computer to monitor and control the state of one or more projectors on a network.



You will need a serial ↔ IP conversion adapter and cable to connect an EMP-6000 to a network so that you can monitor it with EMP Monitor. You can check product information and operation compatibility at the homepage address mentioned above.

*3 Except for "High Altitude Mode".

Network Menu (EMP-6100 Only)

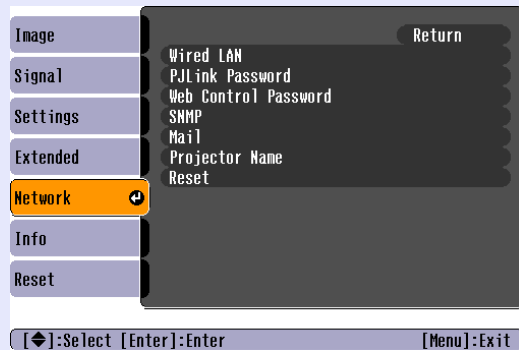
When "Network Protect" is set to "On" in "Password Protect", a message is displayed and the settings cannot be changed. You can make changes after setting "Network Protect" to "Off".  [p.23](#)



Sub Menu	Function
Wired LAN	<p>DHCP: You can set whether to use DHCP (On) or not (Off). If this is set to "On" you cannot set any more addresses.</p> <p>IP Address: You can input the IP address assigned to the projector.*¹ You can input a number from 0 to 255 in each field of the address. However, the following IP addresses cannot be used. 0.0.0.0, 0.x.x.x, 127.x.x.x, 224.0.0.0 to 255.255.255.255 (where x is a number from 0 to 255)</p> <p>Subnet Mask: You can input the subnet mask for the projector.*¹ You can input a number from 0 to 255 in each field of the address. However, the following subnet masks cannot be used. 0.0.0.0, 255.255.255.255</p> <p>Gateway Address: You can input the IP address for the gateway for the projector.*¹ You can input a number from 0 to 255 in each field of the address. However, the following gateway addresses cannot be used. 0.0.0.0, 127.x.x.x, 224.0.0.0 to 255.255.255.255 (where x is a number from 0 to 255)</p> <p>MAC Address: You can display the MAC address for the projector.</p>
PJLink Password	<p>You can input the authentication password when accessing the projector by using the PJLink compatible application software.*¹  p.71</p> <p>You can use numbers and letters and it can be up to 32 characters in length.</p>
Web Control Password	<p>You can input the authentication password when setting and controlling the projector using Web control.*¹ You can use numbers and letters and it can be up to 8 characters in length.</p> <p>Web control is a computer function that allows you to control the projector by using a computer's Web browser when starting up EMP Monitor.</p> <p> EMP Monitor Operation Guide</p>

Sub Menu	Function
<u>SNMP</u> ▶▶	<p>Set the SNMP.</p> <p>Trap IP Address 1/Trap IP Address 2: You can register up to two for the SNMP trap notification destination. The IP address registered in "Trap IP Address 2" is used when the IP address registered in "Trap IP Address 1" cannot be accessed.</p> <p>Community Name: Enter the community name for SNMP. You can enter up to 8 numbers and letters. You have to install the SNMP program on your computer to monitor the projector using SNMP. SNMP should be managed by a network expert.</p>
Mail	<p>When this is set, if the projector enters an abnormal/warning state you are notified by e-mail.*2</p> <p>Mail Notification: You can set whether to be notified by mail (On) or not (Off).</p> <p>SMTP Server: You can input the IP address for the SMTP server for the projector.*1 You can input a number from 0 to 255 in each field of the address. However, the following IP addresses cannot be used. 127.x.x.x, 224.0.0.0 to 255.255.255.255 (where x is a number from 0 to 255)</p> <p>Port Number: You can input the port number for the SMTP server.*1 The initial value is 25. You can input numbers between 1 to 65535.</p> <p>Address 1 Setting/Address 2 Setting/Address 3 Setting: You can input the mail address*1 and the contents of the message to receive notification when an abnormality or a warning occurs. You can input up to three destinations. You can use numbers and letters for the mail address and it can be up to 32 characters in length.</p>
Projector Name	You can display an individual name to identify the projector on the network.
Reset	<p>You can reset all adjustment values for the "Network" menu functions to their default settings.</p> <p>To return all menu items to their default settings, see  p.39</p>

*1 When inputting numbers and passwords, the following soft keyboards are displayed. Tilt the remote control [⊙] button to move the cursor to the target key, and press the [Enter] button to input. After inputting, press [Finish] on the keyboard to confirm your input. Press [Cancel] on the keyboard to cancel your input.

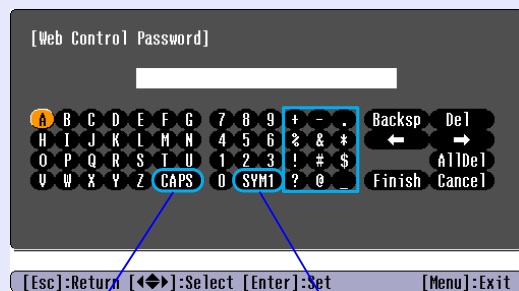

Each time this key is selected, it sets and changes between upper case and lower case letters.

Each time this key is selected, it sets and changes the symbol keys for the section enclosed by the frame.

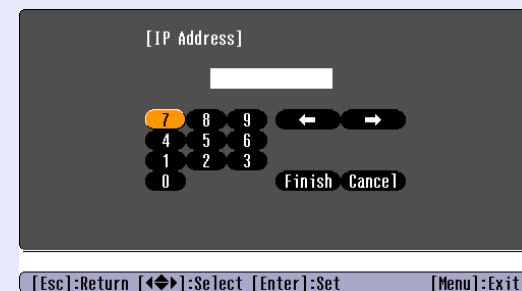

*2 When the mail notification function is set to "On" and the projector enters an abnormal/warning state, the following mail is sent.

Subject: EPSON Projector

First line: The projector name of the projector where the abnormality occurs

Second line: The IP address set for the projector where the abnormality occurs

Third line and on: Details of the abnormality

The details of the abnormality are described one by one, one line at a time. The following table explains the details shown in the message.

For details on dealing with abnormalities/warnings, see "Reading the Indicators" (🖱️ p.42).

Message	Cause
Internal error	An internal error has occurred.
Fan related error	A fan error has occurred.
Sensor error	A sensor error has occurred.
Lamp cover is open.	The lamp cover is open.
Lamp timer failure	Lamp failure has occurred.
Lamp out	A lamp error has occurred.
Internal temperature error	A high temperature error has occurred. (Overheating)
High-speed cooling in progress	A high temperature warning has occurred.
Lamp replacement notification	It is time to replace the lamp.
Air Filter Replace	It is time to replace the air filter.
No Air Filter	There is no air filter installed.
Low Air Flow	A low air flow error has occurred.
Air Flow Sensor Error	An air flow sensor error has occurred.
No-signal	No Signal No image signal is being input to the projector. Check the connection status for the projector and that the power supply for the connected equipment is turned on.

The (+) or (-) at the beginning of the sentence

(+): An error has occurred in the projector

(-): An error in the projector has been dealt with

Info Menu (Display Only)

Lets you check the status of the image signals being projected and the status of the projector. Items displayed vary depending on the image signal currently being projected as shown in the following screen shots.

Computer image/Component video»

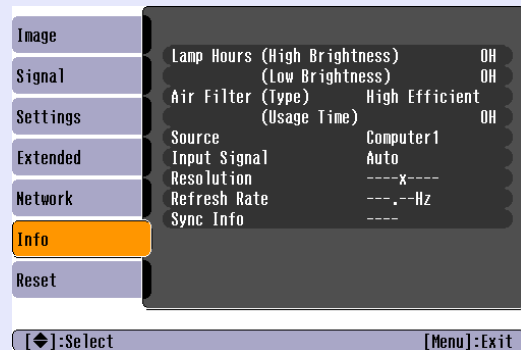

Composite video»/S-video»

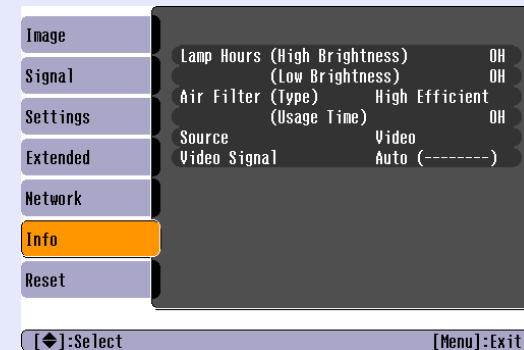

Sub Menu	Function
Lamp Hours	You can display the cumulative lamp operating time* . When it reaches the lamp warning time, the characters are displayed in yellow.
Air Filter	You can display the type of air filter and the cumulative use time* . If the "Alarm Timer" is set to "On" in "Air Filter Setting" from the "Extended" menu, when it reaches the air filter replacement time, the characters are displayed in yellow.
Source	You can display the input port name for the connected equipment currently being projected.
Input Signal	You can display the content of "Computer1" or "Computer2" set in the "Signal" menu according to the "Source".
Resolution	You can display the input resolution.
Video Signal	You can display the content of "Video Signal" set in the "Signal" menu.
<u>Refresh Rate</u> »	You can display the refresh rate.
<u>Sync.</u> » Info	You can display the image signal information. This information may be needed if service is required.

* The cumulative use time is displayed as "OH" for the first 10 hours.

Reset Menu



Sub Menu	Function
Reset All	You can reset all items in the configuration menus to their default settings. The following items are not reset to their defaults: "Computer1 Input", "Computer2 Input", "User's Logo", "Multi-screen", all items for "Network" menus (EMP-6100 only), "Air Filter Usage Time", "Lamp Hours", and "Language".
Reset Air Filter Time	You can clear the cumulative air filter use time, and return it to "0H". Reset when you replace the air filter.
Reset Lamp Hours	You can clear the cumulative lamp hours use time, and return it to "0H". Reset when you replace the lamp.



Troubleshooting

This chapter describes how to identify problems and what to do if a problem is found.

Using the Help	41
Problem Solving	42
• Reading the Indicators	42
⏻ Power indicator lights red	43
☀ · 📶 · 📶 Indicator is lit or flashing orange	44
• When the Indicators Provide No Help	45
Problems relating to images	46
Problems when projection starts.....	50
Other problems	50

If a problem occurs with the projector, Help uses on-screen displays to assist you in solving the problem.

Procedure

- 1 Press the [Help] button.**
The help screen is displayed.

Using the remote control

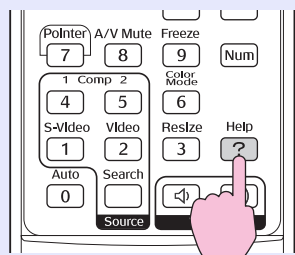

Using the control panel

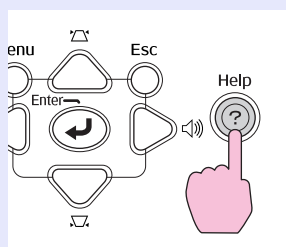

- 2 Select a menu item.**

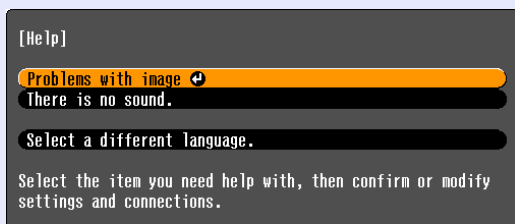

[◀]:Select [Enter]:Enter [Help]:Exit

Using the remote control

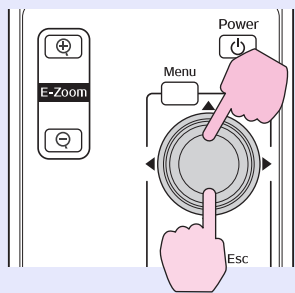

Using the control panel

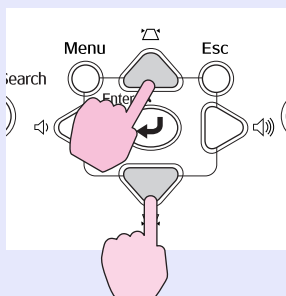

- 3 Confirm the selection.**

Using the remote control

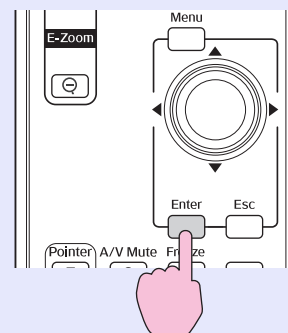

Using the control panel

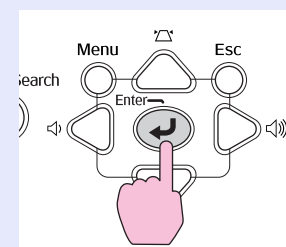

- 4 Use the same operations as procedures 2 and 3 to proceed through the menu to more detailed items.**
Press the [Help] button to exit Help.

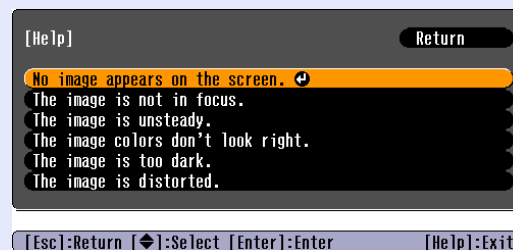

If Help does not provide a solution to the problem, refer to "Problem Solving" (p.42).

If you are having a problem with the projector, first check the projector's indicators and refer to "Reading the Indicators" below. If the indicators do not show clearly what the problem might be, refer to "When the Indicators Provide No Help".  [p.45](#)

Reading the Indicators

The projector is provided with the following four indicators that indicate the operating status of the projector.

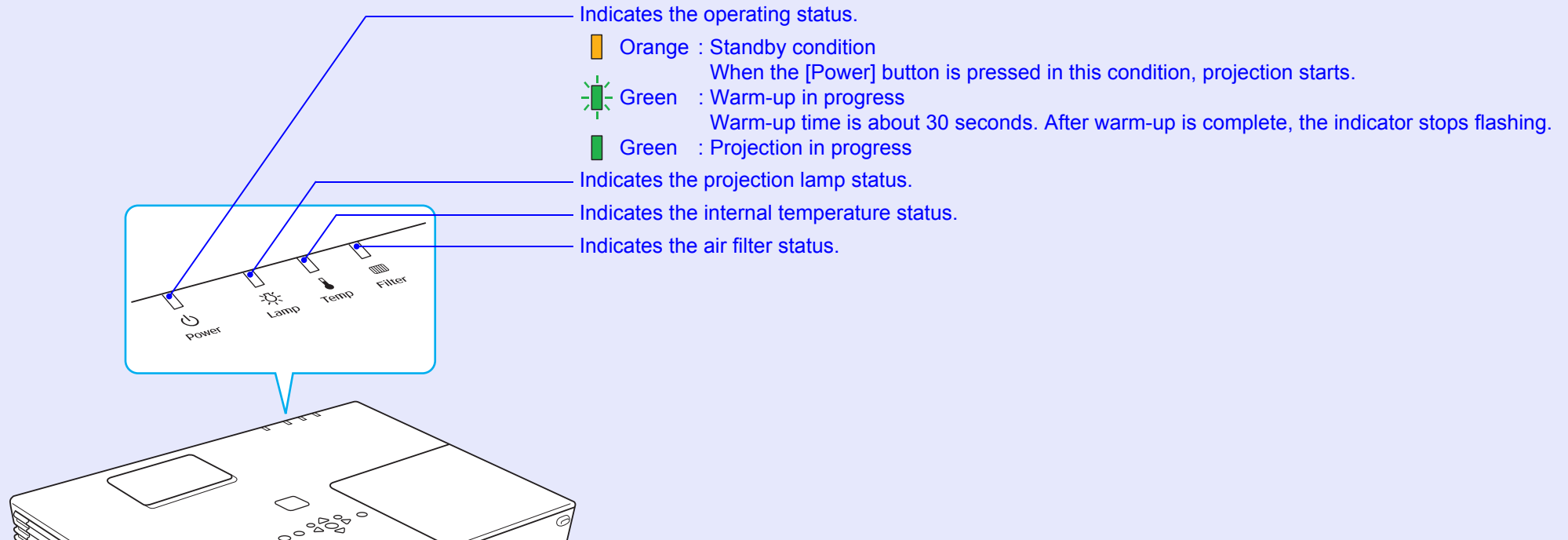

Refer to the following table to see what the indicators mean and how to remedy problems that they indicate.

If all indicators are off, check that the power cable is connected correctly and that the power is being supplied normally. Sometimes, when the power cable is unplugged, the  indicator remains lit for a short period, this is not a fault.

■ Power indicator lights red **Abnormal**

: Lit : Flashing: : Off

Status	Cause	Remedy or Status
<p>Red Red Red</p>	Internal Error	Stop using the projector, disconnect the power cable from the electrical outlet, and contact your local dealer or the nearest address provided in the <i>World-Wide Warranty Terms</i> . Inquiries
<p>Red</p>	Fan Error Sensor Error	Stop using the projector, disconnect the power cable from the electrical outlet, and contact your local dealer or the nearest address provided in the <i>World-Wide Warranty Terms</i> . Inquiries
<p>Red</p>	High Temp Error (overheating)	<p>The lamp turns off automatically and projection stops. Wait for about five minutes. After about five minutes the projector switches to standby mode, so check the following two points.</p> <ul style="list-style-type: none"> • Check that the air filter and air exhaust vent are clear, and that the projector is not positioned against a wall. • If the air filter is clogged, clean or replace it. p.54, 60 <p>If the error continues after checking the points above, stop using the projector, disconnect the power cable from the electrical outlet, and contact your local dealer or the nearest address provided in the <i>World-Wide Warranty Terms</i>. Inquiries</p> <p>When using at an altitude of 1500 m or more, set "High Altitude Mode" to "On". p.33</p>
<p>Red Red</p>	Lamp Error Lamp Failure Lamp Cover Open	<p>Check the following two points.</p> <ul style="list-style-type: none"> • Take out the lamp and check if it is cracked. p.57 • Clean the air filter. p.54 <p>If it is not cracked → Re-fit the lamp and turn on the power. If the error continues → Replace the lamp with a new lamp and turn on the power. If the error continues → Stop using the projector, disconnect the power cable from the electrical outlet, and contact your local dealer or the nearest address provided in the <i>World-Wide Warranty Terms</i>. Inquiries</p> <p>If it is cracked → Replace it with a new lamp, or contact your local dealer for further advice. If replacing the lamp yourself, be careful to avoid pieces of broken glass (you cannot continue projecting until the lamp is replaced).</p> <p>Check that the lamp cover and the lamp are securely installed. p.57 If the lamp cover or the lamp is not securely installed, the lamp does not switch on.</p> <p>When using at an altitude of 1500 m or more, set "High Altitude Mode" to "On". p.33</p>

■ ☀ · 🔌 · 📊 Indicator is lit or flashing orange **Warning**

■: Lit ■: Flashing □: Off ▨: Varies according to the projector status

Status	Cause	Remedy or Status
<p>Red Orange</p> <p>■ □ ■ □</p> <p>☀ 🔌 🔌 📊</p>	High Temp Warning	<p>(This is not an abnormality. However, if the temperature rises too high again, projection stops automatically.)</p> <ul style="list-style-type: none"> • Check that the air filter and air exhaust vent are clear, and that the projector is not positioned against a wall. • If the air filter is clogged, clean or replace it. 🖱️ p.54, 60
<p>Orange</p> <p>▨ ■ □ □</p> <p>☀ 🔌 🔌 📊</p>	Replace Lamp	<p>Replace it with a new lamp. 🖱️ p.57</p> <p>If you continue to use the lamp after the replacement period has passed, the possibility that the lamp may explode increases. Replace it with a new lamp as soon as possible.</p>
<p>Orange</p> <p>▨ □ □ ■</p> <p>☀ 🔌 🔌 📊</p>	No Air Filter	<p>Check that the air filter is securely installed. 🖱️ p.60</p>
<p>Orange</p> <p>▨ □ □ ■</p> <p>☀ 🔌 🔌 📊</p>	Air Flow Sensor Err. (EMP-6100 only)	<p>Check that the air filter is securely installed. 🖱️ p.60</p> <p>If the error continues when an air filter is installed, the air filter sensor is malfunctioning. Stop using the projector, disconnect the power cable from the electrical outlet, and contact your local dealer or the nearest address provided in the <i>World-Wide Warranty Terms</i>. 🖱️ Inquiries</p>
<p>Orange</p> <p>▨ □ □ ■</p> <p>☀ 🔌 🔌 📊</p>	Low Air Flow (EMP-6100 only)	<p>If the message "The air filter is clogged. Clean or replace the air filter." is displayed, check the following two points.</p> <ul style="list-style-type: none"> • Check that the air filter and air exhaust vent are clear, and that the projector is not positioned against a wall. • If the air filter is clogged, clean or replace it. 🖱️ p.54, 60 <p>Replace the air filter if the force of the air flow through the air filter decreases even after repeated cleaning. 🖱️ p.60</p> <p>If the error continues after checking the points above, stop using the projector, disconnect the power cable from the electrical outlet, and contact your local dealer or the nearest address provided in the <i>World-Wide Warranty Terms</i>. 🖱️ Inquiries</p>
	Replace Air Filter	<p>If the message "Clean or replace the air filter." is displayed, clean the air filter.</p> <p>If the air filter has become brown because of tobacco smoke and so on, and you cannot clean it well, replace it with a new air filter.</p> <p>* The indicator and the message telling you when to replace the air filter are only displayed when "Alarm Timer" is set to "On" in the "Air Filter Setting" menu from the "Extended" menu. 🖱️ p.34</p>













- If the projector is not operating properly, even though the indicators are all showing normal, refer to "When the Indicators Provide No Help" (🖱️ p.45).
- If an indicator is displaying a status not described in the tables, contact your local dealer or the nearest address provided in the *World-Wide Warranty Terms*.

When the Indicators Provide No Help

If any of the following problems occur and the indicators do not offer a solution, refer to the pages given for each problem.



Problems relating to images

- **No images appear**  [p.46](#)
Projection does not start, the projection area is completely black, the projection area is completely blue, and so on.
- **Moving images are not displayed**  [p.46](#)
Moving images being projected from a computer appear black and nothing is projected.
- **Projection stops automatically**  [p.46](#)
- **The message "Not supported." is displayed**  [p.47](#)
- **The message "No Signal." is displayed**  [p.47](#)
- **Images are fuzzy or out of focus**  [p.47](#)
- **Interference or distortion appears in images**  [p.48](#)
Problems such as interference, distortion, or black & white checked patterns appear.
- **The image is truncated (large) or small, or the aspect is not suitable**  [p.48](#)
Only part of the image is displayed, or the height and width ratios of the image are not correct, and so on.
- **Image colours are not right**  [p.49](#)
The whole image appears purplish or greenish, images are black & white, colours appear dull, and so on.
(Computer monitors and LCD screens have different colour reproduction performance, so that the colours projected by the projector and the colours appearing on the monitor may not necessarily match, but this is not a sign of a problem.)
- **Images appear dark**  [p.49](#)
- **Nothing appears on the external monitor**  [p.49](#)

Problems when projection starts

- **Power does not turn on**  [p.50](#)



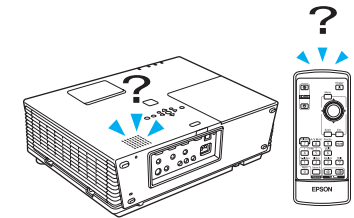

Other problems

- **No sound can be heard or the sound is faint**  [p.50](#)
- **The remote control does not work**  [p.50](#)
- **Mail is not received even if an abnormality occurs in the projector (EMP-6100 only)**  [p.51](#)



■ Problems relating to images



■ No images appear

Check	Remedy
Did you press the [Power] button?	Press the [Power] button to turn the power on.
Are the indicators switched off?	The power cable is not connected correctly or power is not being supplied normally. Connect the projector's power cable correctly.  <i>Quick Start Guide</i> Check that your electrical outlet or power source is functioning correctly.
Is A/V Mute active?	Press the [A/V Mute] button on the remote control to cancel A/V Mute.  p.15
Are the configuration menu settings correct?	Reset all of the settings.  "Reset"- "Reset All" p.39
Is the projected image completely black? Only when projecting computer images	Some input images, such as screen savers, may be completely black.
Is the image signal format setting correct? Only when projecting images from a video source	Change the setting according to the signal for the connected equipment.  "Signal"- "Video Signal" p.30



■ Moving images are not displayed

Check	Remedy
Is the computer's image signal being output to the LCD and the monitor? Only when projecting images from a laptop computer or a computer with a built-in LCD screen	Change the image signal to external output only.  Check your computer's documentation.



■ Projection stops automatically

Check	Remedy
Is "Sleep Mode" set to "On"?	Press the [Power] button to turn the power on. If you do not want to use "Sleep Mode", change the setting to "Off".  "Extended"- "Operation"- "Sleep Mode" p.33
Is an air filter installed?	A message is displayed if the projector is used without an air filter, and the power turns off automatically after about one minute. Install an air filter and then turn the projector on.  p.60



■ The message "Not supported." is displayed

Check	Remedy
Is the image signal format setting correct? Only when projecting images from a video source	Change the setting according to the signal for the connected equipment.  "Signal"- "Video Signal" p.30
Do the image signal resolution and the refresh rate correspond to the mode? Only when projecting computer images	Refer to the computer's documentation for how to change the image signal resolution and the refresh rate output from the computer.  "List of Supported Monitor Displays" p.72

■ The message "No Signal." is displayed

Check	Remedy
Are the cables connected correctly?	Check that all the cables required for projection are securely connected.  <i>Quick Start Guide</i>
Is the correct input port selected?	Change the image by pressing the [Source Search] button on the remote control or the control panel.  p.12
Is the power for the computer or video source turned on?	Turn the power on for the equipment.
Are the image signals being output to the projector? Only when projecting images from a laptop computer or a computer with a built-in LCD screen	If the image signals are only being output to the computer's LCD monitor or to the accessory monitor, you need to change the output to an external destination as well as the computer's own monitor. For some computer models, when the image signals are output externally, they no longer appear on the LCD monitor or accessory monitor.  Computer's documentation, under a title such as "External output" or "Connecting an external monitor" If the connection is made while the power of the projector or computer is already turned on, the function [Fn] key that changes the computer's image signal to external output may not work. Turn the power for the computer and the projector off and then back on again.

■ Images are fuzzy or out of focus

Check	Remedy
Is the focus adjusted correctly?	Turn the focus ring to adjust the focus.  <i>Quick Start Guide</i>
Is the projector at the correct distance?	The recommended projection distance ranges from 83 to 1469 cm (2.7 to 48.2 ft). Setup within this range.  p.64
Is the Keystone adjustment value too large?	Lower the projection angle to reduce the amount of keystone correction.  <i>Quick Start Guide</i>
Has condensation formed on the lens?	If the projector is suddenly taken from a cold environment to a warm environment, or if sudden ambient temperature changes occur, condensation may form on the surface of the lens, and this may cause the images to appear fuzzy. Set the projector up in the room about one hour before it is used. If condensation forms on the lens, turn the projector off and wait for the condensation to disappear.









■ Interference or distortion appear in images

Check	Remedy
Is the image signal format setting correct? Only when projecting images from a video source	Change the setting according to the signal for the connected equipment. 🖱️ "Signal"- "Video Signal" p.30
Are the cables connected correctly?	Check that all the cables required for projection are securely connected. 🖱️ <i>Quick Start Guide</i>
Is an extension cable being used?	If an extension cable is used, electrical interference may affect the signals. Use the cables supplied with the projector to check if the cables you are using may be causing the problem.
Is the correct resolution selected? Only when projecting computer images	Set the computer so that the signals being output are compatible with the projector. 🖱️ "List of Supported Monitor Displays" p.72 🖱️ Computer documentation
Are the "Sync.▶▶" and "Tracking▶▶" settings adjusted correctly? Only when projecting computer images	Press the [Auto] button on the remote control or the [Enter] button on the control panel to perform automatic adjustment. If the images are not adjusted correctly after using automatic adjustment, you can make the adjustments using "Sync." and "Tracking" from the configuration menu. 🖱️ "Signal"- "Tracking", "Sync." p.30





■ The image is truncated (large) or small, or the aspect is not suitable

Check	Remedy
Is a wide panel computer image being projected? Only when projecting computer images	Press the [Resize] button on the remote control to change the aspect mode in the order of "Normal", "4:3", and "16:9". Change the aspect mode according to the resolution.
Is the image still being enlarged by E-Zoom?	Press the [Esc] button on the remote control to cancel E-Zoom. 🖱️ p.18
Is "Position" adjusted correctly?	Press the [Auto] button on the remote control or the [Enter] button on the control panel to perform automatic adjustment of the computer image being projected. If the images are not adjusted correctly after using automatic adjustment, you can make the adjustments using "Position" from the configuration menu. Apart from computer image signals, you can adjust other signals while projecting by adjusting "Position" from the configuration menu. 🖱️ "Signal"- "Position" p.30
Is the computer set for dual display? Only when projecting computer images	If dual display is activated in the "Display Properties" of the computer's control panel, only about half of the image on the computer screen is projected. To display the entire image on the computer screen, turn off the dual display setting. 🖱️ Computer video driver documentation
Is the correct resolution selected? Only when projecting computer images	Set the computer so that the signals being output are compatible with the projector. 🖱️ "List of Supported Monitor Displays" p.72 🖱️ Computer documentation

■ Image colours are not right

Check	Remedy
Do the input signal settings match the signals from the connected device?	Change the following settings according to the signal for the connected equipment. When projecting images from equipment connected to Computer1 or Computer2 port  "Signal"- "Computer1/2 Input" p.30 When projecting images from equipment connected to Video or S-Video port  "Signal"- "Video Signal" p.30
Is the image brightness adjusted correctly?	Adjust the "Brightness" setting from the configuration menu.  "Image"- "Brightness" p.29
Are the cables connected correctly?	Check that all the cables required for projection are securely connected.  Quick Start Guide
Is the <u>contrast</u>  setting adjusted correctly?	Adjust the "Contrast" setting from the configuration menu.  "Image"- "Contrast" p.29
Is the colour adjusted correctly?	Adjust the "Color Adjustment" setting from the configuration menu.  "Image"- "Color Adjustment" p.29
Are the colour saturation and tint adjusted correctly?	Adjust the "Color Saturation" and "Tint" settings from the configuration menu.  "Image"- "Color Saturation", "Tint" p.29
Only when projecting images from a video source	

■ Images appear dark





Check	Remedy
Are the image brightness and luminance adjusted correctly?	Adjust the "Brightness" and "Brightness Control" settings from the configuration menu.  "Image"- "Brightness" p.29  "Settings"- "Brightness Control" p.31
Is the <u>contrast</u>  setting adjusted correctly?	Adjust the "Contrast" setting from the configuration menu.  "Image"- "Contrast" p.29
Is the lamp due for replacement?	When the lamp is nearly ready for replacement, the images become darker and the colour quality becomes poorer. When this happens, replace the lamp with a new lamp.  p.57

■ Nothing appears on the external monitor

Check	Remedy
Are images from a port other than the Computer1 port being projected?	The only images that can be displayed on an external monitor are computer images from Computer1 port.  p.65



■ **Problems when projection starts**

■ **Power does not turn on**

Check	Remedy
Did you press the [Power] button?	Press the [Power] button to turn the power on.
Are the indicators switched off?	The power cable is not connected correctly or power is not being supplied normally. Connect the projector's power cable correctly.  Quick Start Guide Check that your electrical outlet or power source is functioning correctly
Do the indicators turn on and off when the power cable is touched?	There is probably a poor contact in the power cable, or the power cable may be defective. Reinsert the power cable. If this does not solve the problem, stop using the projector, disconnect the power cable from the electrical outlet, and contact your local dealer or the nearest address provided in the <i>World-Wide Warranty Terms</i> .  Inquiries
Is the operation lock set to "Full Lock"?	Press and hold down the [Enter] button on the control panel for about seven seconds, a message is displayed and the lock is released.  p.25
Is the correct setting for the remote receiver selected?	Check "Remote Receiver" from the configuration menu.  "Settings"->"Remote Receiver" p.31
Was the power cable plugged back in immediately after Direct Power Off, or is the breaker turned off?	When the operation to the left is performed when "Direct Power On" is set to "On", the power may not turn back on. Press the [Power] button to turn the power back on.



■ **Other problems**



■ **No sound can be heard or the sound is faint**

Check	Remedy
Is the audio source connected correctly?	Check that the cable is connected to the Audio port.
Is the volume adjusted to the minimum setting?	Adjust the volume so that sound can be heard.  Quick Start Guide
Is A/V Mute active?	Press the [A/V Mute] button on the remote control to cancel A/V Mute.  p.15
Is the audio source setting correct?	Check the "RCA Audio Input" setting on the configuration menu.  p.31





Only when video equipment is connected to the EMP-6100

■ **The remote control does not work**

Check	Remedy
Is the remote control light-emitting area pointing towards the remote receiver on the projector when it is operated?	Point the remote control towards the remote receiver. The operating angle for the remote control is about 30° horizontally, and about 15° vertically.  Quick Start Guide
Is the remote control too far from the projector?	The operating range for the remote control is about 6 m.  Quick Start Guide

Check	Remedy
Is direct sunlight or strong light from fluorescent lamps shining onto the remote receiver?	Set the projector up in a location where strong light does not shine onto the remote receiver. Or, set the remote receiver to "Off" in "Remote Receiver" from the configuration menu.  "Settings"->"Remote Receiver" p.31
Is the correct setting for the remote receiver selected?	Check the "Remote Receiver" from the configuration menu.  "Settings"->"Remote Receiver" p.31
Are the batteries dead or have the batteries been inserted correctly?	Make sure the batteries are inserted correctly or replace the batteries with new ones if necessary.  p.56
Was a remote control button pressed for more than 30 seconds?	If any of the buttons on the remote control are pressed down for more than 30 seconds, the remote control stops sending signals (remote control's sleep mode). This feature is to prevent the batteries running down if the remote control buttons are held down accidentally such as when it is stored in a bag or if an object is placed on top of it. When the button is released, normal remote control operation resumes.

■ Mail is not received even if an abnormality occurs in the projector (EMP-6100 only)

Check	Remedy
Is the LAN cable connected correctly?	Check that the LAN cable is connected correctly. Reconnect it if it is not connected or it is not connected correctly.  p.66
Is "Mail" set correctly in the configuration menu?	Mail notification of abnormalities is sent according to the "Mail" settings in the configuration menu. Check if it is set correctly.  "Network"->"Mail" p.36
Is "Standby Mode" set to "Network On"?	To use the mail notification function when the projector is in standby, set "Network On" in "Standby Mode" from the configuration menu.  "Extended"->"Standby Mode" p.33
Did a fatal abnormality occur and the projector come to a sudden stop?	When it comes to a sudden stop, mail cannot be sent. If the abnormal state continues, contact your local dealer or the nearest address provided in the <i>World-Wide Warranty Terms</i> .  Inquiries
Is power being supplied to the projector?	Check that your electrical outlet or power source is functioning correctly.



Appendices

This chapter provides information on maintenance procedures to ensure the best level of performance from the projector for a long time to come.

Installation Methods	53	Connecting a LAN Cable (EMP-6100 Only)	66
Cleaning.....	54	Optional Accessories and Consumables	67
• Cleaning the Projector's Surface.....	54	Optional accessories.....	67
• Cleaning the Lens Cover Glass.....	54	Consumables	67
• Cleaning the Air Filter.....	54	Glossary	68
Replacing Consumables	56	List of ESC/VP21 Commands.....	70
• Replacing the Remote Control Batteries	56	• Command List	70
• Replacing the Lamp	57	• Cable Layouts	70
Lamp replacement period.....	57	Serial connection.....	70
How to replace the lamp.....	57	PJLink (EMP-6100 Only)	71
Resetting the lamp operating time.....	59	List of Supported Monitor Displays	72
• Replacing the Air Filter	60	Computer image.....	72
Air filter replacement period	60	Component video	72
How to replace the air filter.....	60	Composite video/S-video.....	72
Resetting the air filter operating time.....	61	Specifications	73
Saving a User's Logo	62	Appearance.....	76
Screen Size and Distance	64	Index.....	77
Connecting to External Equipment.....	65		
• Connecting to an External Monitor	65		
• Connecting to External Speakers (EMP-6100 Only).....	65		

The projector supports the following four different projection methods.

Attention

- *A special method of installation is required when suspending the projector from the ceiling (ceiling mount). If it is not installed correctly, it could fall causing an accident and injury.*
- *If you use adhesives on the ceiling mount to prevent the screws from loosening, or if you use things such as lubricants or oils on the projector, the projector case may crack causing it to fall from its ceiling mount. This could cause serious injury to anyone under the ceiling mount and could damage the projector. When installing or adjusting the ceiling mount, do not use adhesives to prevent the screws from loosening and do not use oils or lubricants and so on.*
- *Do not use the projector on its side. This may cause malfunctions to occur.*

- **Project images from in front of the screen (Front projection)**

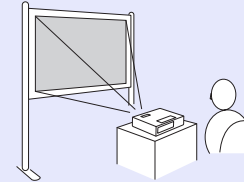

- **Project images from behind a translucent screen (Rear projection)**

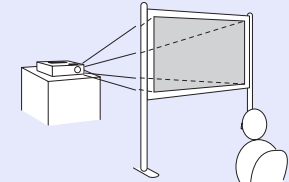

- **Suspend the projector from the ceiling and project images from in front of the screen. (Front/Ceiling projection)**

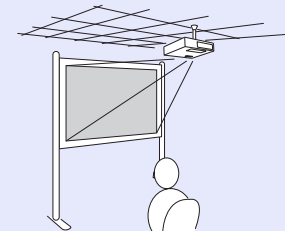

- **Suspend the projector from the ceiling and project images from behind a translucent screen. (Rear/Ceiling projection)**

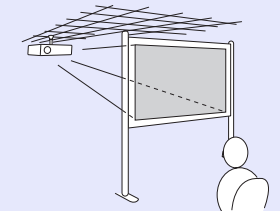

- *An optional ceiling mount is required when suspending the projector from the ceiling. [p.67](#)*
- *You can change the setting as follows by pressing down the [A/V Mute] button on the remote control for about five seconds.
"Front" ↔ "Front/Ceiling"
Set "Rear" or "Rear/Ceiling" from the configuration menu. [p.33](#)*

You should clean the projector if it becomes dirty or if the quality of projected images starts to deteriorate.

Cleaning the Projector's Surface

Clean the projector's surface by wiping it gently with a soft cloth. If the projector is particularly dirty, moisten the cloth with water containing a small amount of neutral detergent, and then firmly wring the cloth dry before using it to wipe the projector's surface.

Attention

Do not use volatile substances such as wax, alcohol, or thinner to clean the projector's surface. The quality of the case may change or become discoloured.

Cleaning the Lens Cover Glass

Use a commercially available cloth for cleaning glasses to gently wipe the lens cover glass.

Attention

Do not rub the lens cover glass with harsh materials or subject the lens to shocks, as it can easily become damaged.

Cleaning the Air Filter

Clean the air filter when the following message is displayed.

- "The air filter is clogged. Clean or replace the air filter."
- "Clean or replace the air filter."

However, if the air filter has turned brown because it has been stained by tobacco smoke and so on, it cannot be cleaned. In this case, replace it with a new air filter.  "How to replace the air filter" [p.60](#)

Attention

- *If dust collects on the air filter it can cause the internal temperature of the projector to rise, and this can lead to problems with operation and shorten the optical engine's service life. Clean the air filter immediately when the message is displayed.*
- *If you continue to use the air filter after it has turned brown and been stained with tobacco resin, the optical engine deteriorates quickly and the luminance intensity falls.*

Procedure**1 Open the air filter cover.**

While pushing the air filter catches, pull the cover down.

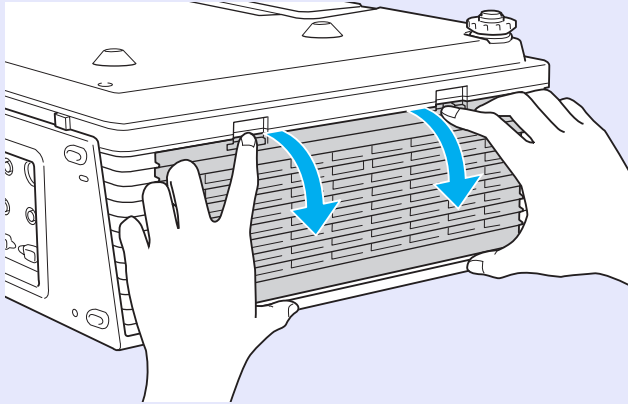
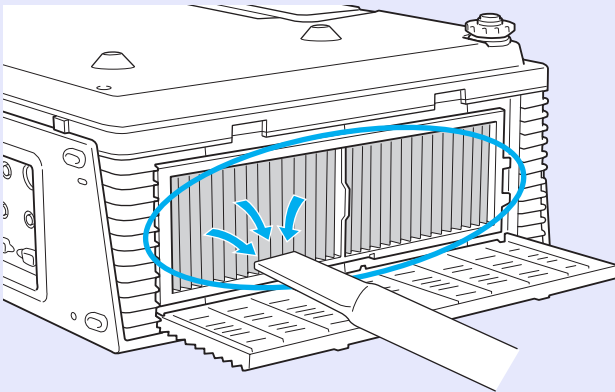
**2 Use a vacuum cleaner to remove dust from the air filter.**

- After cleaning the air filter, make sure you set "Reset Air Filter Time" from the configuration menu. [p.39](#)
- If a message is frequently displayed, even after cleaning, it is time to replace the air filter. Replace it with a new air filter. [p.60](#)

This section explains how to replace the remote control batteries, the lamp, and the air filter.

Replacing the Remote Control Batteries

If delays in the responsiveness of the remote control occur or if it does not operate after it has been used for some time, it probably means that the batteries are becoming flat. When this happens, replace them with new batteries. Have two spare AAA-size alkali batteries ready to use when required.

Attention

Make sure you read the Safety Instructions/World-Wide Warranty Terms before handling the batteries.  [Safety Instructions](#)

Procedure

1 Remove the battery cover.

While pushing the battery compartment cover catch, lift the cover up.

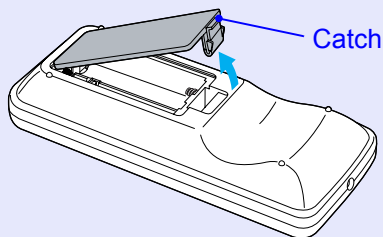

2 Replace the old batteries with new batteries.

Attention

Check the positions of the (+) and (-) marks inside the battery holder to ensure the batteries are inserted the correct way.

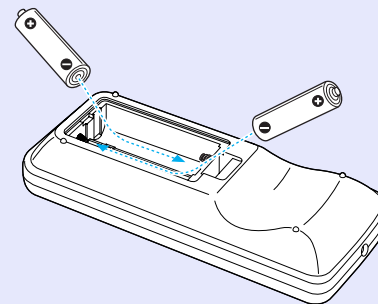

3 Replace the battery cover.

Press the battery compartment cover until it clicks into place.

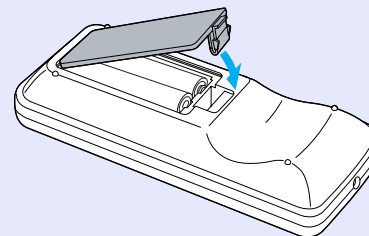

Replacing the Lamp

Lamp replacement period

It is time to replace the lamp when:

- The message "Replace the lamp." is displayed when you start projecting.

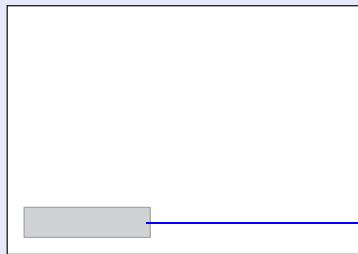

A message is displayed.

- The lamp indicator flashes orange.

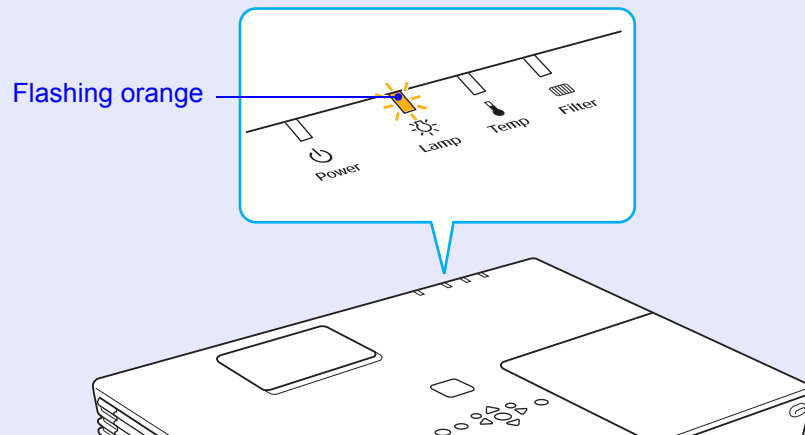

- The projected image gets darker or starts to deteriorate

Attention

- *The lamp replacement message is set to appear after the following time periods in order to maintain the initial brightness and quality of the projected images. ["Brightness Control" p.31](#)*
 - *When used continually at high brightness: About 1900 hours*
 - *When used continually at low brightness: About 2900 hours*
- *If you continue to use the lamp after the replacement period has passed, the possibility that the lamp may explode increases. When the lamp replacement message appears, replace the lamp with a new one as soon as possible, even if it is still working.*
- *Depending on the characteristics of the lamp and the way it has been used, the lamp may become darker or stop working before the lamp warning message appears. You should always have a spare lamp ready incase it is needed.*

How to replace the lamp

Attention

- *When replacing the lamp because it has stopped illuminating, there is a possibility that the lamp may be broken. If replacing the lamp of a projector which has been installed on the ceiling, you should always assume that the lamp is broken, and you should stand to the side of the lamp cover, not underneath it. Remove the lamp cover gently. Small pieces of glass may fall out when the lamp cover is opened. If pieces of glass get into your eyes or mouth, seek medical advice immediately.*
- *Wait until the lamp has cooled down sufficiently before removing the lamp cover. If the lamp is still hot, burns or other injuries may result. It takes about one hour after the power has been turned off for the lamp to be cool enough.*

Procedure

1 After you turn off the projector's power and the confirmation buzzer beeps twice, disconnect the power cable.

2 Wait until the lamp has cooled down, then remove the lamp cover from the surface of the projector.

Open the lamp cover by inserting the screwdriver supplied with the new lamp into the lamp cover side switch, and remove the lamp cover without removing the screwdriver.

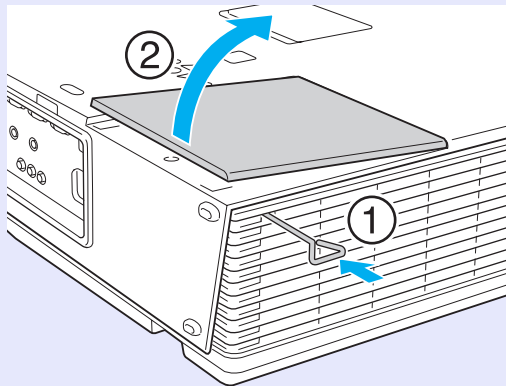

3 Loosen the two lamp fixing screws.

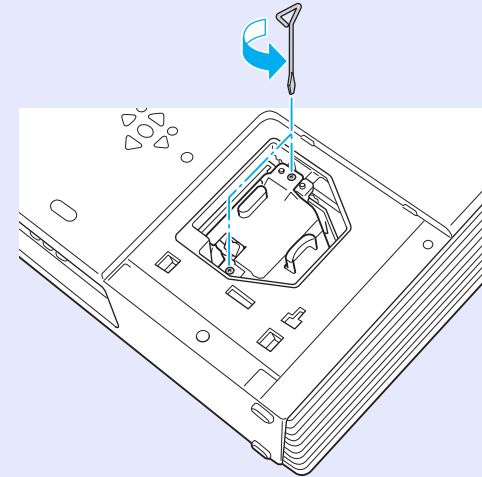

4 Take out the old lamp.

If the lamp is cracked, replace it with a new lamp, or contact your local dealer for further advice. If replacing the lamp yourself, be careful to avoid pieces of broken glass.

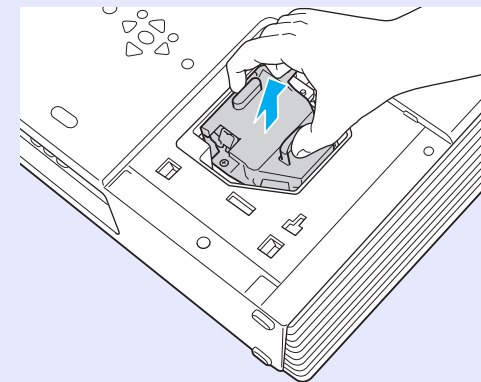

5 Install the new lamp.

Insert the new lamp so that the lamp fits in place correctly and, once it is fully inserted, tighten the two screws.

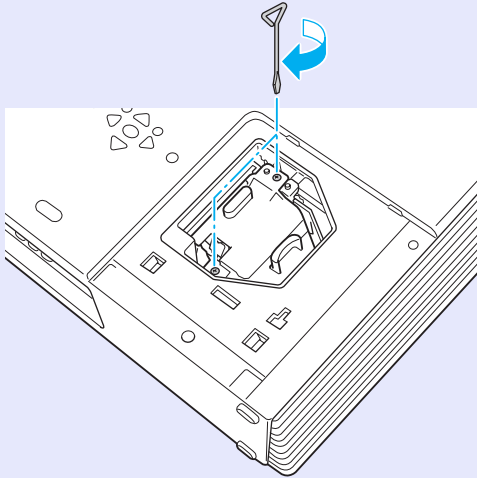

Attention

- *Make sure you install the lamp securely. If the lamp cover is removed, the lamp turns off automatically as a safety precaution. If the lamp or the lamp cover is not installed correctly, the lamp does not turn on.*
- *This product includes a lamp component that contains mercury (Hg). Please consult your local regulations regarding disposal or recycling. Do not dispose of it with normal household waste.*

6 Replace the lamp cover.

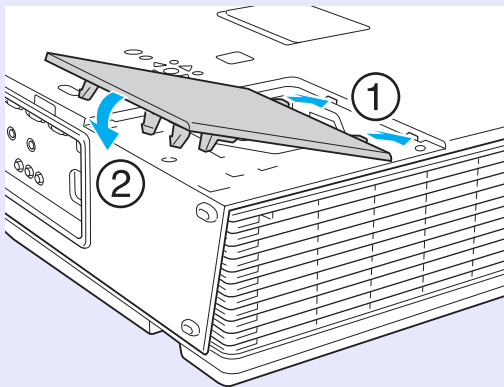

Resetting the lamp operating time

The projector records how long the lamp is turned on and a message and indicator notify you when it is time to replace the lamp. After replacing the lamp, make sure you reset the lamp hours from the configuration menu. [p.39](#)



Only reset the lamp operating time after the lamp has been replaced, otherwise the lamp replacement period is not indicated correctly.

Replacing the Air Filter

Air filter replacement period

It is time to replace the air filter when:

- The air filter has been turned brown by such things as tobacco resin.
- When the message "The air filter is clogged. Clean or replace the air filter." is frequently displayed, even though the air filter has been cleaned.

How to replace the air filter

The air filter can be replaced even when the projector is suspended from a ceiling.

Procedure

- 1** After you turn off the projector's power and the confirmation buzzer beeps twice, disconnect the power cable.

2 Open the air filter cover.

While pushing the air filter cover catches, pull the cover down.

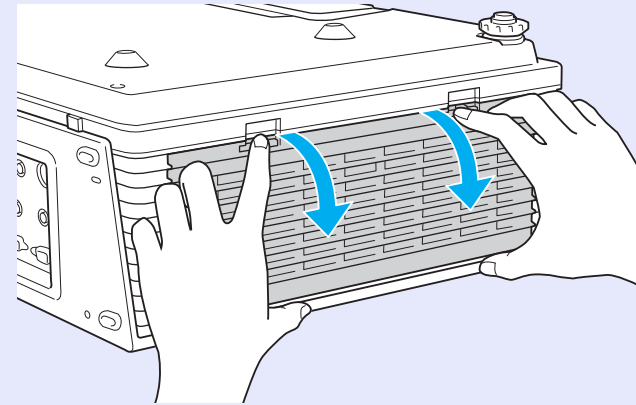

3 Remove the air filter.

Grip the raised part at the centre of the air filter and pull it straight out.

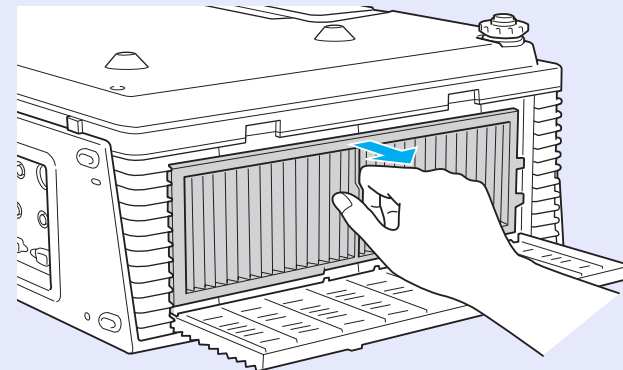

4 Install the new air filter.

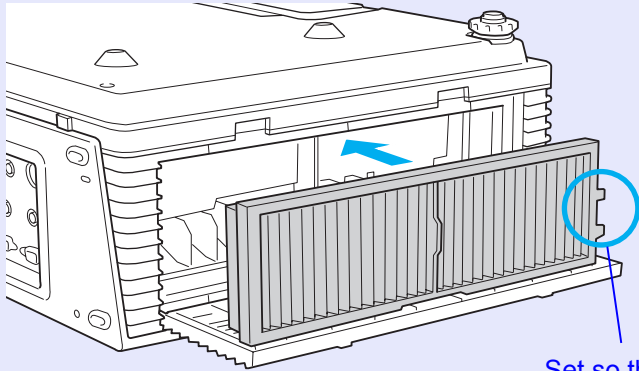

Set so that the projected ridge points to the front of the projector.

5 Close the air filter cover.

Press the cover until it clicks into place.

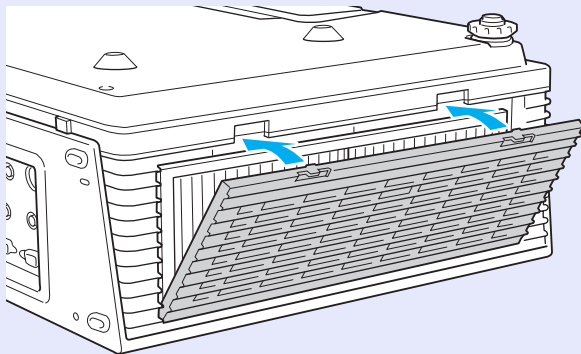

- *Make sure you install an air filter. A message is displayed if the projector is used without an air filter, and the power turns off automatically after about one minute.*
- *Dispose of used air filters properly in accordance with your local regulations.
Material quality of the frame section: PP
Material quality of the filter section: PP-PET*

■ **Resetting the air filter operating time**

The projector keeps a running total of the time the air filter is used and a message and indicator notify you when it is time to replace the air filter. After replacing the air filter, make sure you reset the air filter time from the configuration menu. p.39



- *Do not reset the air filter operating time except after replacing or cleaning the air filter.*
- *If "Alarm Timer" is set to "Off" in "Air Filter Setting" from the configuration menu, the projector does not inform you when it is time to replace the air filter even if the air filter replacement time is reached.*

You can save the image that is currently being projected as a user's logo.



When a user's logo is saved, the previous user's logo is erased.

Procedure

1 Project the image you want to use as the user's logo, and then press the [Menu] button.

Using the remote control

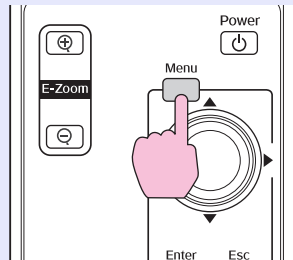

Using the control panel

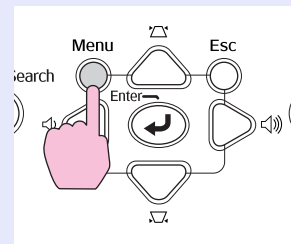

2

From the configuration menu, select "Extended" - "User's Logo". "Using the Configuration Menu" p.28

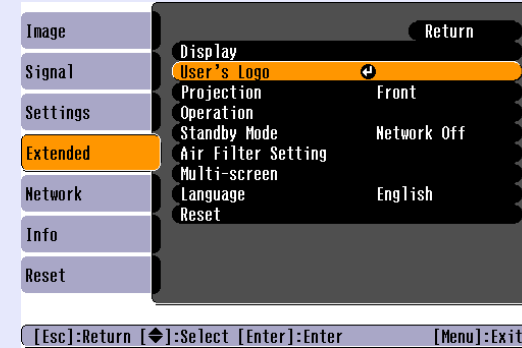

Check the buttons you can use and the operations they perform in the guide under the menu.



- If "User's Logo Protect" from "Password Protect" is set to "On", a message is displayed and the user's logo cannot be changed. You can make changes after setting "User's Logo Protect" to "Off". p.23
- If "User's Logo" is selected when Keystone, E-Zoom, Resize, and Progressive are being performed, the function currently being performed is cancelled.

3

When "Choose this image as the User's Logo?" is displayed, select "Yes".



When you press the [Enter] button on the remote control or the control panel, the screen size may change according to the signal as it changes to the resolution of the image signal.

- 4** The image is recorded and a selection marquee box is displayed. Move the box to select the part of the image to use as the user's logo.

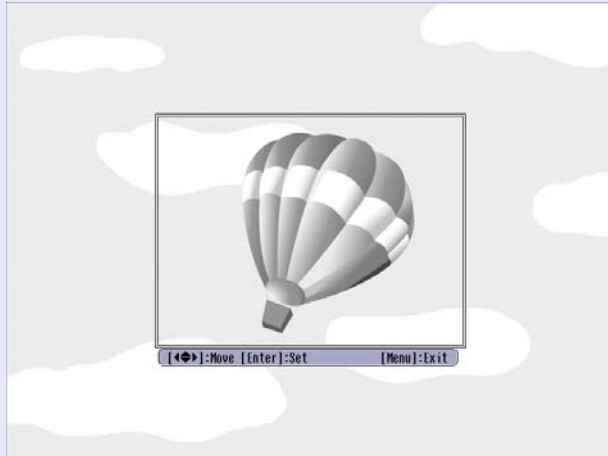

Using the remote control

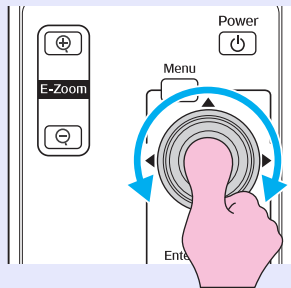

Using the control panel

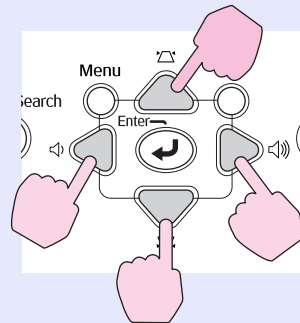

- 5** When "Select this image?" is displayed, select "Yes".
- 6** Select the zoom factor from the zoom setting screen.

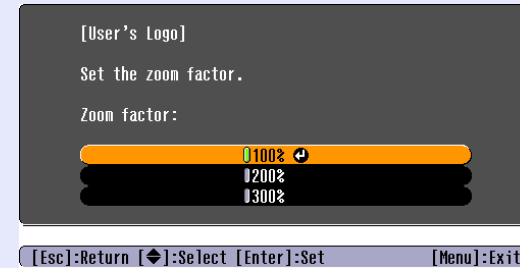

- 7** When the message "Save this image as the User's Logo?" is displayed, select "Yes".

The image is saved. After the image has been saved, the message "Completed" is displayed.



- Saving the user's logo may take about 15 seconds. Do not use the projector or any connected equipment while it is saving, otherwise malfunctions may occur.
- Once a user's logo has been saved, the logo cannot be returned to the factory default.



You can save at up to 400 × 300 dots in size.

See the following table to choose the best position for your projector. The values are only a guide.

Units: cm (in.)

Units: cm (ft)

Units: cm (in.)

4:3 Screen Size		Projection Distance A		Distance from the Centre of the Lens to the Base of the Screen B
		Minimum (Zoom Adjustment Wide)	Maximum (Zoom Adjustment Tele)	
30"	61 × 46 (24.0 × 18.1)	83 to 139 (2.7 to 4.6)		4 (1.6)
40"	81 × 61 (31.9 × 24.0)	114 to 189 (3.7 to 6.2)		6 (2.2)
50"	100 × 76 (39.4 × 30.0)	144 to 238 (4.7 to 7.8)		7 (2.7)
60"	120 × 90 (47.2 × 35.4)	174 to 287 (5.7 to 9.4)		8 (3.3)
80"	160 × 120 (63.0 × 47.2)	235 to 386 (7.7 to 12.6)		11 (4.4)
100"	200 × 150 (78.7 × 59.1)	296 to 484 (9.7 to 15.9)		14 (5.5)
120"	240 × 180 (94.4 × 70.8)	357 to 583 (11.7 to 19.1)		17 (6.5)
150"	300 × 230 (118.1 × 90.6)	449 to 730 (14.7 to 24.0)		21 (8.2)
200"	410 × 300 (161.4 × 118.1)	601 to 977 (19.7 to 32.0)		28 (10.9)
300"	610 × 460 (240.2 × 181.1)	906 to 1469 (29.7 to 48.2)		42 (16.4)

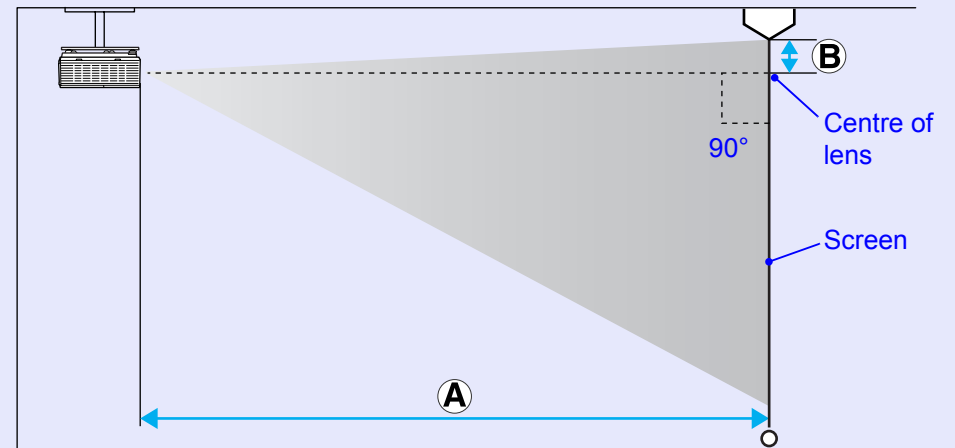
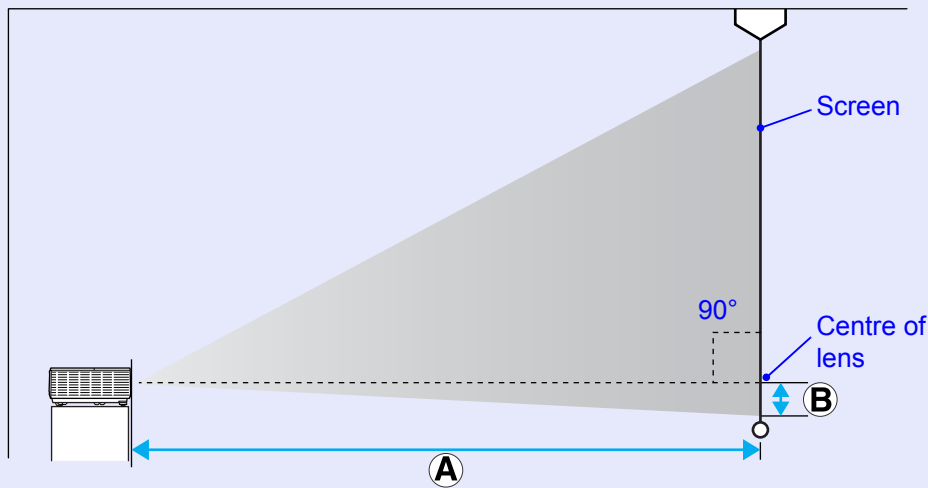

Connecting to an External Monitor

Computer images being input to the Computer1 port can be displayed on an external monitor and the screen at the same time when connected to the projector. This means that you can check projected images on an external monitor when giving presentations even if you cannot see the screen. Connect to an external monitor using the cable supplied with the monitor.

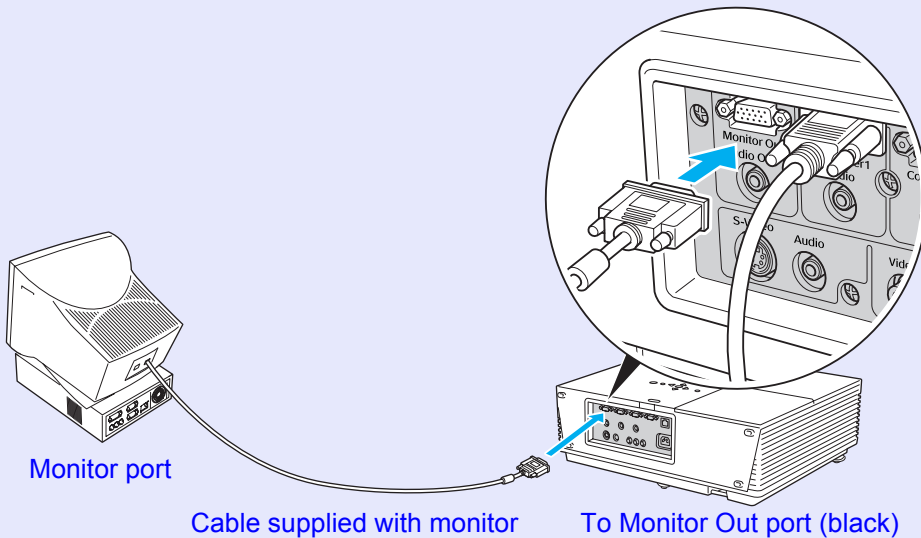

- **Component video signals and equipment connected to the Computer2 port, Video port, and S-Video port cannot be output to an external monitor.**
- **The setting gauge for Keystone, the configuration and help screen, and so on are not output to an external monitor.**

Connecting to External Speakers (EMP-6100 Only)

You can connect speakers with built-in amplifiers to the projector's Audio Out port to enjoy a fuller quality of sound. Connect with a commercially available audio cable (pin plug ↔ 3.5 mm stereo mini plug and so on). Use an audio cable compatible with the connector on the external speakers.

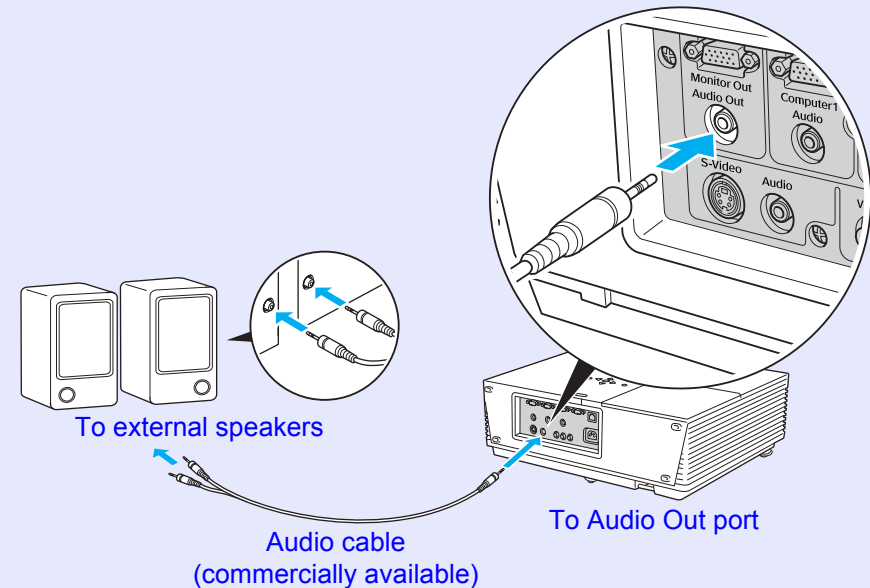

When an audio cable plug is inserted in the Audio Out port, the audio changes to the external destination, and audio is no longer emitted from the projector's built-in speaker.

Connecting a LAN Cable (EMP-6100 Only)



Connect with a commercially available 100baseTX or 10baseT type LAN cable.

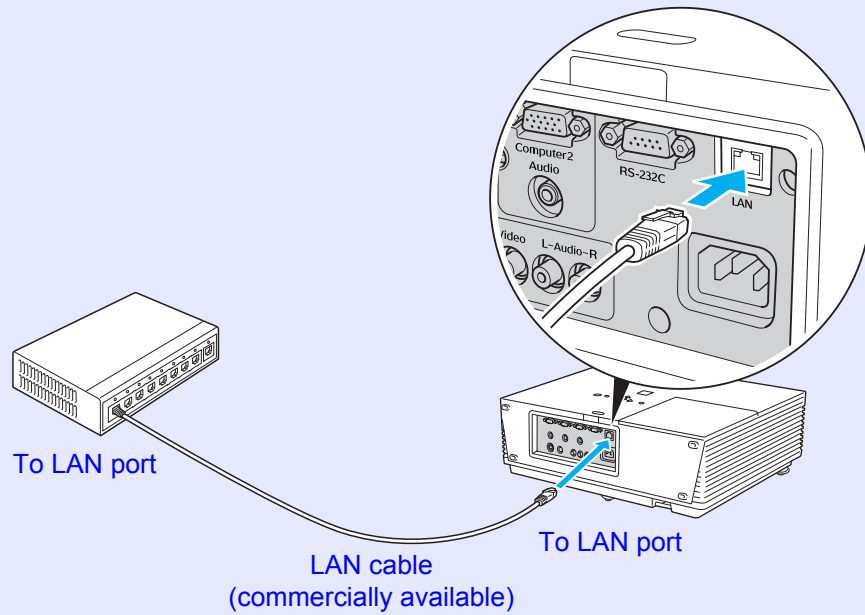

Attention
To prevent malfunctions, use a category 5 shielded LAN cable.

The following list of optional accessories is current as of July, 2006. Details of accessories are subject to change without notice and availability may vary depending on the country of purchase.

■ Optional accessories

60" portable screen ELPSC07
80" portable screen ELPSC08
100" screen ELPSC10
Portable roll-type screens ([Aspect ratio](#)▶▶4:3)

50" portable screen ELPSC06
A compact screen that can be carried easily (Aspect ratio 4:3)

HD-15 cable ELPKC02
(1.8 m - for mini D-Sub 15-pin/mini D-Sub 15-pin)
This is the same as the computer cable supplied with the projector.

HD-15 cable ELPKC09
(3 m - for mini D-Sub 15-pin/mini D-Sub 15-pin)
HD-15 PC cable ELPKC10
(20 m - for mini D-Sub 15-pin/mini D-Sub 15-pin)
Use one of these longer cables if the computer cable supplied with the projector is too short.

Component video cable ELPKC19
(3 m - for mini D-Sub 15-pin/RCA male × 3)
Use to connect a [component video](#)▶▶ source.

Ceiling plate* ELPFC03
Ceiling pipe 370 mm (silver)* ELPFP04
Ceiling pipe 570 mm (silver)* ELPFP05
Ceiling pipe 770 mm (silver)* ELPFP06
Suspension adapter 450 mm (cable cover attachment for ELPMB21)* ELPFP11
Suspension adapter 700 mm (cable cover attachment for ELPMB21)* ELPFP12
Use when installing the projector on a high ceiling.

Ceiling mount* ELPMB07
Ceiling mount (for use as ceiling plate)* ELPMB21
Use when installing the projector on a ceiling.

* A special method of installation is required to suspend the projector from a ceiling. Contact your local dealer or the nearest address provided in the *World-Wide Warranty Terms* if you want to use this installation method.  [Inquiries](#)

■ Consumables

Lamp unit ELPLP37
Use as a replacement for used lamps.

Air filter (high efficient) ELPAF11
(Use to filter general dust, clouds of dust, and chalk dust)

Air filter (smoke) ELPAF12
(Use to filter cigarette smoke)
Use as a replacement for used air filters. Choose one of the two types depending on the projector's environment.

This section explains easily terms that are used with the projector and difficult terms that are not explained in the text of this guide. For details, refer to other commercially available publications.

Aspect ratio	The ratio between an image's length and its height. HDTV images have an aspect ratio of 16:9 and appear elongated. The aspect ratio for standard images is 4:3.
Component video	A video signal which has the luminance component and colour component separated to provide better image quality. Refers to images that consist of three independent signals: Y (luminance signal), Pb and Pr (colour difference signals).
Composite video	Video signals that have the video brightness signals and colour signals mixed together. The type of signals commonly used by household video equipment (NTSC, PAL, and SECAM formats). The carrier signal Y (luminance signal) and chroma (colour) signal that are contained in the colour bar are overlapped to form a single signal.
Contrast	The relative brightness of the light and dark areas of an image can be increased or decreased to make text and graphics stand out more clearly, or to make them appear softer. Adjusting this particular property of an image is called "contrast adjustment".
Dolby Digital	A sound format developed by Dolby Laboratories. Normal stereo is a 2-channel format that uses two speakers. Dolby Digital is a 6-channel (5.1-channel) system which adds to this a centre speaker, two rear speakers, and a sub-woofer.
HDTV	An abbreviation for High-Definition Television that refers to high-definition systems which satisfy the following conditions. <ul style="list-style-type: none"> • Vertical resolution of 750p or 1125i or greater (p =<u>progressive</u>, i =<u>interlace</u>) • Screen <u>aspect ratio</u> of 16:9 • <u>Dolby Digital</u> audio reception and playback (or output)
Interlace	A method of image scanning whereby the image data is divided into fine horizontal lines that are displayed in sequence starting from left to right and then from top to bottom. The even-numbered lines and odd-numbered lines are displayed alternately.
Progressive	A method of image scanning whereby the image data from a single image is scanned sequentially from top to bottom to create a single image.
Refresh rate	The light-emitting element of a display maintains the same luminosity and colour for an extremely short time. Because of this, the image must be scanned many times per second to refresh the light-emitting element. The number of refresh operations per second is called the Refresh rate and is expressed in hertz (Hz).
SDTV	An abbreviation for Standard Definition Television that refers to standard television systems which do not satisfy the conditions for <u>HDTV</u> High-Definition Television.
SNMP	An abbreviation for Simple Network Management Protocol, which is the protocol for monitoring and controlling devices such as routers and computers connected to a TCP/IP network.
Squeeze mode	In this mode, wide-screen images in 16:9 mode are compressed in the horizontal direction so that they are stored on the recording medium as 4:3 images. When these images are played back by the projector in squeeze mode, they are restored to their original 16:9 format.
sRGB	An international standard for colour intervals that was formulated so that colours that are reproduced by video equipment can be handled easily by computer operating systems (OS) and the Internet. If the connected source has an sRGB mode, set both the projector and the connected signal source to sRGB.

SVGA	A type of video signal with a resolution of 800 (horizontal) × 600 (vertical) dots that is used by IBM PC/AT-compatible computers.
S-video	A video signal which has the luminance component and colour component separated to provide better image quality. Refers to images that consist of two independent signals: Y (luminance signal) and C (colour signal).
SXGA	A type of video signal with a resolution of 1280 (horizontal) × 1024 (vertical) dots that is used by IBM PC/AT-compatible computers.
Synchronization	The signals output from computers have a specific frequency. If the projector frequency does not match this frequency, the resulting images are not of a good quality. The process of matching the phases of these signals (the relative position of the crests and the troughs in the signal) is called Synchronization. If the signals are not synchronized, flickering, blurriness, and horizontal interference occur.
Tracking	The signals output from computers have a specific frequency. If the projector frequency does not match this frequency, the resulting images are not of a good quality. The process of matching the frequency of these signals (the number of crests in the signal) is called Tracking. If tracking is not carried out correctly, wide vertical stripes appear in the signal.
VGA	A type of video signal with a resolution of 640 (horizontal) × 480 (vertical) dots that is used by IBM PC/AT-compatible computers.
XGA	A type of video signal with a resolution of 1024 (horizontal) × 768 (vertical) dots that is used by IBM PC/AT-compatible computers.

Command List

When the power ON command is transmitted to the projector, the power turns on and it enters warm-up mode. When the projector's power has turned on, a colon ":" (3Ah) is returned.

When a command is input, the projector executes the command and returns a ":", and then accepts the next command.

If the command being processed terminates abnormally, an error message is output and a ":" is returned.

Item		Command	
Power ON/OFF	ON	PWR ON	
	OFF	PWR OFF	
Signal selection	Video	SOURCE 41	
	S-Video	SOURCE 42	
A/V Mute ON/OFF	ON	MUTE ON	
	OFF	MUTE OFF	
A/V Mute selection	Black	MSEL 00	
	Blue	MSEL 01	
	Logo	MSEL 02	
Item		Command	
		Computer1 Port	Computer2 Port
Signal selection	Computer (Auto)	SOURCE 1F	SOURCE 2F
	Computer	SOURCE 11	SOURCE 21
	Component Video	SOURCE 14	SOURCE 24

* Add a Carriage Return (CR) code (0Dh) to the end of each command and transmit.

Cable Layouts

Serial connection

- Connector shape : D-Sub 9-pin (male)
- Projector input connector : RS-232C

<At the projector>



<At the computer>

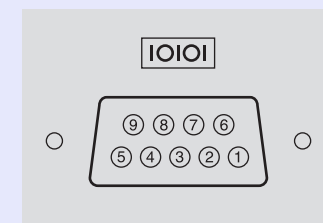

<At the projector>	(PC serial cable)	<At the computer>
GND 5	————— 5	GND
RD 2	←———— 3	TD
TD 3	————→ 2	RD
DTR 4	————→ 6	DSR
DSR 6	←———— 4	DTR

Signal	Function
GND	Signal wire ground
TD	Transmit data
RD	Receive data
DSR	Data set ready
DTR	Data terminal ready

PJLink Class 1 was established by the JBMIA (Japan Business Machine and Information System Industries Association) as a standard protocol for controlling network-compatible projector's as part of their efforts to standardize projector control protocols.

The projector complies with the PJLink Class 1 standard established by the JBMIA.

It complies with all commands except for the following commands defined by PJLink Class 1, and agreement was confirmed by the PJLink standard adaptability verification.

■ Non-compatible commands

Function		PJLink Command
Mute settings	Image muting set	AVMT 11
	Image muting cancel	AVMT 10
	Audio muting set	AVMT 21
	Audio muting cancel	AVMT 20
Mute status queries	Normal (only images muted)	AVMT=11
	Normal (only audio muted)	AVMT=21

■ Input names defined by PJLink and corresponding projector connectors

Input Connector	PJLink Command
Computer1	INPT 11
Computer2	INPT 12
Video	INPT 21
S-Video	INPT 22

■ Manufacturer name displayed for "Manufacture name information query"

EPSON

■ Model name displayed for "Product name information query"

EMP-6100

■ Computer image

Signal	Refresh Rate [▶] (Hz)	Resolution (dots)	Number of Pixels Used When Display is Resized (dots)
VGAEGA		640 × 350	1024 × 560
VGA [▶]	60/72/75/85, iMac*	640 × 480	1024 × 768
SVGA [▶]	56/60/72/75/85, iMac*	800 × 600	1024 × 768
XGA [▶]	60/70/75/85, iMac*	1024 × 768	1024 × 768
SXGA [▶]	70/75/85	1152 × 864	1024 × 768
SXGA	60/75/85	1280 × 960	1024 × 768
SXGA	60/75/85	1280 × 1024	960 × 768
UXGA	60	1600 × 1200	1024 × 768
MAC13"		640 × 480	1024 × 768
MAC16"		832 × 624	1024 × 768
MAC19"		1024 × 768	1024 × 768
MAC19"	60	1024 × 768	1024 × 768
MAC21"		1152 × 870	1016 × 768
SDTV [▶] (525i)	60	720 × 480	1024 × 768
SDTV (625i)	50	720 × 576	1024 × 768
SDTV (525p)	60	720 × 480	1024 × 768
SDTV (625p)	50	720 × 576	1024 × 768
HDTV [▶] (750p)	50/60	1280 × 720	1024 × 576
HDTV (1125i)	50/60	1920 × 1080	1024 × 576

* Connection is not possible if the equipment does not have a VGA output port.

Even when signals other than those mentioned above are input, it is likely that the image can be projected. However, not all functions may be supported.

■ Component video

Signal	Refresh Rate [▶] (Hz)	Resolutions (dots)	
		Aspect Ratio [▶] 4:3	Aspect Ratio 16:9
SDTV [▶] (525i)	60	1024 × 768	1024 × 576
SDTV (625i)	50	1024 × 768	1024 × 576
SDTV (525p)	60	1024 × 768	1024 × 576
SDTV (625p)	50	1024 × 768	1024 × 576
HDTV [▶] (750p) 16:9	50/60	1024 × 768	1024 × 576
HDTV (1125i) 16:9	50/60	1024 × 768	1024 × 576

■ Composite video/S-video

Signal	Refresh Rate [▶] (Hz)	Resolutions (dots)	
		Aspect Ratio [▶] 4:3	Aspect Ratio 16:9
TV (NTSC)	60	1024 × 768	1024 × 576
TV (PAL, SECAM)	50	1024 × 768	1024 × 576

Product name		Multimedia Projector EMP-6100	Multimedia Projector EMP-6000
Dimensions		465 (W) × 146 (H) × 340 (D) mm (not including feet)	
Panel size		0.8"	
Display method		Polysilicon TFT active matrix	
Resolution		786432 pixels XGA▶(1024 (W) × 768 (H) dots) × 3	
Focus adjustment		Manual	
Zoom adjustment		Manual (approx. 1 to 1.6)	
Lamp		UHE lamp, 230 W, Model No.: ELPLP37	
Max. audio output		5W monaural	1W monaural
Speaker		1	
Power supply		100 to 240 V AC ±10%, 50/60 Hz 3.7 to 1.6 A	
Power consumption	100 to 120 V area	Operating: 330 W Standby power consumption (network invalid): 0.4 W Standby power consumption (network valid): 10 W	
	230 V area	Operating: 310 W Standby power consumption (network invalid): 0.7 W Standby power consumption (network valid): 9 W	
Operating altitude		Altitude 0 to 3000 m (0 to 9843 ft)	
Operating temperature		0 to +40°C* (No condensation)	
Storage temperature		-10 to +60°C (No condensation)	
Weight		Approx 7 Kg	
Connectors	Computer1 port	1	Mini D-Sub15-pin (female) blue
	Audio port	1	Stereo mini jack
	Computer2 port	1	Mini D-Sub15-pin (female) blue
	Audio port	1	Stereo mini jack
	S-Video port	1	Mini DIN 4-pin
	Audio port	1	Stereo mini jack
	Video port	1	RCA pin jack
	Audio port	1	RCA pin jack
	RS-232C port	1	Mini D-Sub 9-pin (male)
	LAN Port	1	RJ45
	Monitor Out port	1	Mini D-Sub15-pin (female) black
	Audio Out port	1	Stereo mini jack



Pixelworks DNX™ ICs are used in this projector.

Angle of tilt

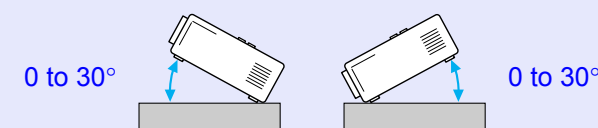

If you use the projector tilted at an angle of more than 30° it could be damaged and cause an accident.

* At an altitude of 1500 to 3000 m, and when "Brightness Control" is set to "High", the operating temperature is 0 to +35°C.

Safety standards

USA
UL60950-1

Canada
CSA C22.2 No.60950-1

EU
The Low Voltage Directive
(73/23/EEC)
IEC/EN60950-1

EMC standards

USA
FCC Part 15B Class B (DoC)

Canada
ICES-003 Class B

EU
The EMC Directive
(89/336/EEC)
EN55022, Class B
EN55024
IEC/EN61000-3-2
IEC/EN61000-3-3

Australia/New Zealand
AS/NZS CISPR 22:2002 Class B

DECLARATION of CONFORMITY

According to 47CFR, Part 2 and 15
Class B Personal Computers and Peripherals; and/or
CPU Boards and Power Supplies used with Class B
Personal Computers

We : Epson America, Inc.
Located at : 3840 Kilroy Airport Way
MS: 3-13
Long Beach, CA 90806
Tel : 562-290-5254

Declare under sole responsibility that the product identified herein, complies with 47CFR Part 2 and 15 of the FCC rules as a Class B digital device. Each product marketed, is identical to the representative unit tested and found to be compliant with the standards. Records maintained continue to reflect the equipment being produced can be expected to be within the variation accepted, due to quantity production and testing on a statistical basis as required by 47CFR 2.909. Operation is subject to the following two conditions :

Trade Name : EPSON

Type of Product : Projector

Model : EMP-6100/EMP-6000

**FCC Compliance Statement
For United States Users**

This equipment has been tested and found to comply with the limits for a Class B digital device, pursuant to Part 15 of the FCC Rules. These limits are designed to provide reasonable protection against harmful interference in a residential installation. This equipment generates, uses, and can radiate radio frequency energy and, if not installed and used in accordance with the instructions, may cause harmful interference to radio or television reception. However, there is no guarantee that interference will not occur in a particular installation. If this equipment does cause interference to radio and television reception, which can be determined by turning the equipment off and on, the user is encouraged to try to correct the interference by one or more of the following measures.

- Reorient or relocate the receiving antenna.
- Increase the separation between the equipment and receiver.
- Connect the equipment into an outlet on a circuit different from that to which the receiver is connected.
- Consult the dealer or an experienced radio/TV technician for help.

WARNING

The connection of a non-shielded equipment interface cable to this equipment will invalidate the FCC Certification or Declaration of this device and may cause interference levels which exceed the limits established by the FCC for this equipment. It is the responsibility of the user to obtain and use a shielded equipment interface cable with this device. If this equipment has more than one interface connector, do not leave cables connected to unused interfaces. Changes or modifications not expressly approved by the manufacturer could void the user's authority to operate the equipment.

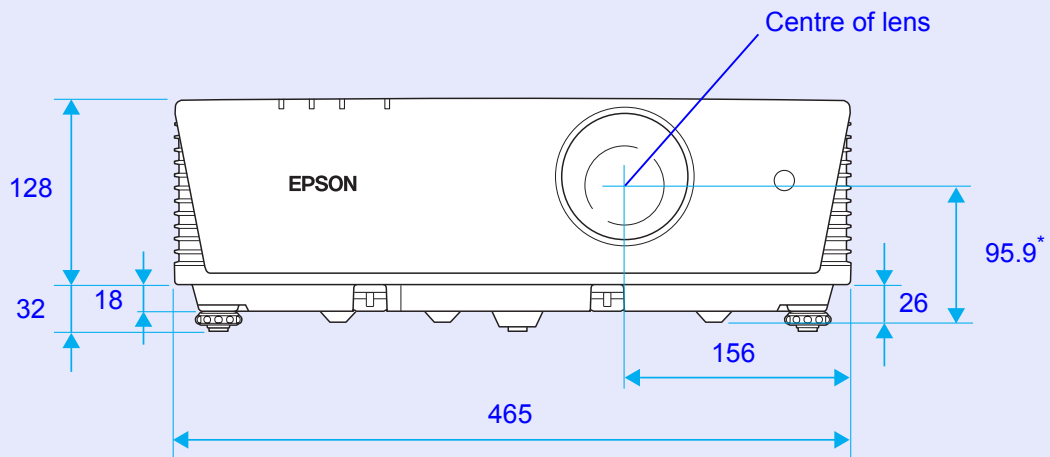

* Distance from centre of lens to suspension bracket fixing point

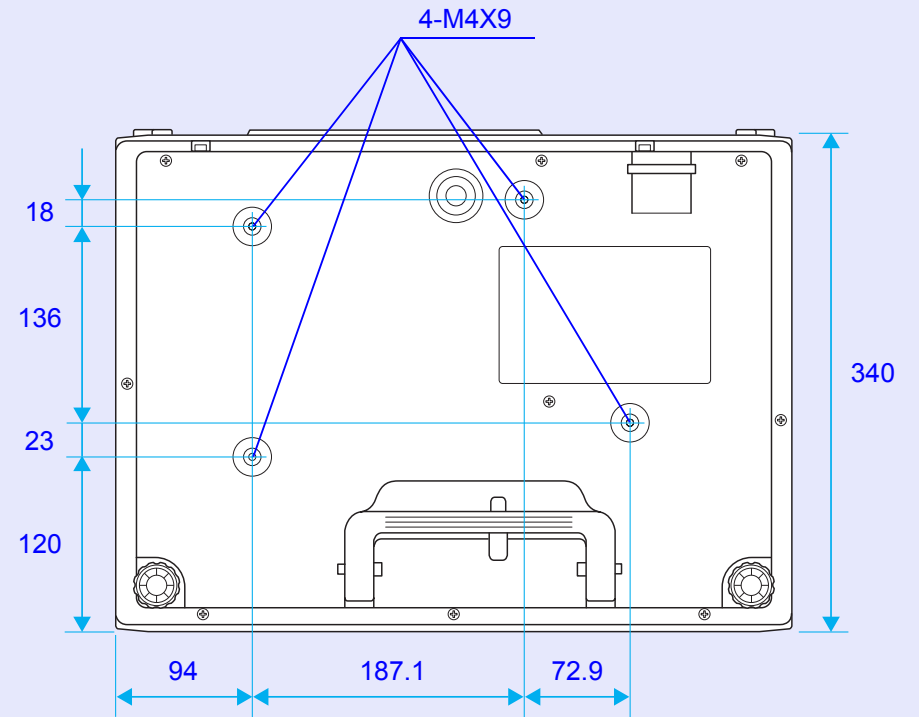

Units: mm

A

A/V mute	15, 33
Abs. color temp	29
Address 1/2/3 setting	36
Adjustment level	20
Air exhaust vent	5
Air filter	5, 38, 67
Air filter replacement period	60
Air filter setting	34
Air intake vent	5
Alarm timer	34
Angle of tilt	73
Appearance	76
Aspect ratio	16, 30
Audio out port	6
Audio port	6
Auto setup	30

B

Blackboard	14
Brightness	29
Brightness control	31

C

Cable cover lock	26
Cleaning the air filter	54
Cleaning the lens cover glass	54
Cleaning the projector's surface	54
Color adjustment	29
Color mode	29
Color saturation	29
Colour mode	14
Community name	36
Computer1 input	30
Computer1 port	6, 7
Computer2 input	30
Computer2 port	6, 7

Configuration menu	28
Connecting a LAN cable	66
Consumables	67
Contrast	29
Control panel	8
Cross	18

D

DHCP	35
Direct power on	33
Display	33
Display background	33

E

ESC/VP21	70
Extended menu	33
External monitor	65
External speakers	65
E-zoom	18

F

Filter indicator	42
Focus ring	5
Freeze	15
Front	33
Front adjustable feet	5
Full lock	25

G

Game	14
Gateway address	35
Glossary	68

H

Handle	10
--------------	----

Help function	41
High altitude mode	33
How to replace the lamp	57

I

Image correction	20, 34
Image menu	29
Indicators	42
Info menu	38
Input signal	38
IP address	35

K

Keystone	31
----------------	----

L

Lamp cover	5
Lamp hours	38
Lamp indicator	42
Lamp replacement period	57
LAN port	6
Language	34
Low	31

M

MAC address	35
Mail	36
Mail notification	36
Menu	28
Message	33
Monitor out port	6, 7
Multi-screen	34
Multi-screen adjustment	19

N

Network menu	35
Network protect	22
Numeric buttons	9

O

Operating temperature	73
Operation	33
Operation lock	25, 31
Optional accessories	67

P

Part names and functions	5
Partial lock	25
Password protect	22
Password protect sticker	23
Password timer	22
Photo	14
PJLink	71
PJLink password	35
Pointer	17
Pointer shape	31
Port number	36
Position	30
Power indicator	42
Power inlet	6, 7
Power on protect	22
Presentation	14
Problem solving	42
Progressive	30
Projection	33
Projection distance	64
Projector name	36

R

RCA audio input	31
-----------------------	----

Rear	33
Rear foot	6, 7
Refresh rate	38
Remote control	9
Remote control light-emitting area	10
Remote receiver	5, 6, 7, 31
Replacing batteries	56
Replacing the air filter	60
Request code	24
Reset all	39
Reset menu	39
Resetting the air filter operating time	39, 61
Resetting the lamp operating time	39, 59
Resize	16, 30, 72
Resolution	38, 72
RS-232C port	6, 7

S

Screen ID	34
Screen size	64
Security cable installation point	10
Security slot	6, 7
Settings menu	31
Sharpness	29
Signal menu	30
Sleep mode	33
SMTP server	36
SNMP	36
Soft keyboard	36
Source	38
Source search	8, 9, 12
Speaker	5
Specifications	73
Sports	14
sRGB	14
Standby mode	33
Startup screen	33
Storage feet	6, 7
Storage temperature	73

Sub menu	28
Subnet mask	35
Supported monitor displays	72
Suspension bracket fixing points	10, 76
S-video port	6, 7
Sync.	30
Sync. info	38

T

Temp indicator	42
Test pattern	32
Theatre	14
Timer	34
Tint	29
Top menu	28
Tracking	30
Trap IP address	36

U

User's logo	62
User's logo protect	22

V

Video port	6, 7
Video signal	30, 38
Volume	8, 9, 31

W

Warning mail	37
Web control password	35
Wide-screen projection	16
Wired LAN	35

Z

Zoom ring	5
-----------------	---

All rights reserved. No part of this publication may be reproduced, stored in a retrieval system, or transmitted in any form or by any means, electronic, mechanical, photocopying, recording, or otherwise, without the prior written permission of Seiko Epson Corporation. No patent liability is assumed with respect to the use of the information contained herein. Neither is any liability assumed for damages resulting from the use of the information contained herein.

Neither Seiko Epson Corporation nor its affiliates shall be liable to the purchaser of this product or third parties for damages, losses, costs, or expenses incurred by the purchaser or third parties as a result of: accident, misuse, or abuse of this product or unauthorized modifications, repairs, or alterations to this product, or (excluding the U.S.) failure to strictly comply with Seiko Epson Corporation's operating and maintenance instructions.

Seiko Epson Corporation shall not be liable against any damages or problems arising from the use of any options or any consumable products other than those designated as Original Epson Products or Epson Approved Products by Seiko Epson Corporation.

The contents of this guide may be changed or updated without further notice.

Illustrations in this guide and the actual projector may differ.

General Notice:

Macintosh, Mac, and iMac are registered trademarks of Apple Computer, Inc.

IBM is a registered trademark of International Business Machines Corporation.

Windows, Windows NT and VGA are trademarks or registered trademarks of Microsoft Corporation in the United States of America.

Dolby is a trademark of Dolby Laboratories.

Pixelworks and DNX are trademarks of Pixelworks, Inc.

Other product names used herein are also for identification purposes only and may be trademarks of their respective owners. Epson disclaims any and all rights in those marks.

This product uses open source software.